

VW36G

FEATURES

- Heavy-duty stainless steel
- Powerful blower options
- LED lights with two brightness settings
- Dishwasher-safe filters
- Front-mounted electronic controls
- Telescoping chimney reaches standard ceiling heights
- Rigorously tested in our U.S. manufacturing facilities for decades of use
- Exceptional 24/7 support from our Customer Care team in Madison

ACCESSORIES

- 600 CFM In-Line Blower
- Chimney Extension - accommodates most 10' ceilings
- Make-up air damper
- Recirculating kit and filter for non-ducted applications
- Recirculating Filter
- Remote Control
- 30" x 30" Stainless Steel Wall Shield

Accessories available through an authorized Sub-Zero dealer. For local dealer information, visit subzero-wolf.com/locator.



BLOWER OPTIONS

- 300 CFM Internal
- 600 CFM Internal
- 600 CFM Inline
- 600 CFM Remote

PRODUCT SPECIFICATIONS

Model	VW36G
Dimensions	36"W x 2 1/4"H x 19 1/4"D
Weight	57 lb
Electrical Supply	110/120 VAC, 60 Hz
Electrical Service	15 amp dedicated circuit
Discharge Location	Vertical
Discharge Dimensions	6" Round
Bottom of Hood to Countertop	24" to 36"
Receptacle	3-prong grounding-type

ELECTRICAL

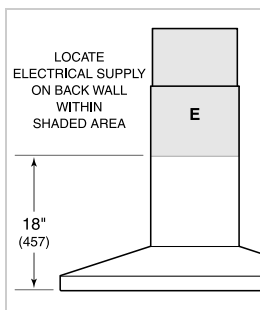

DIMENSIONS

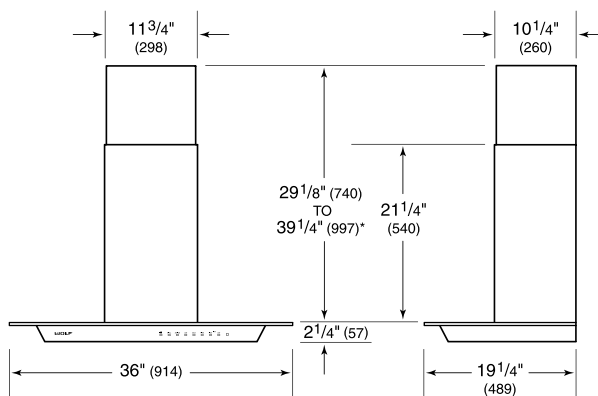

*49 1/8" (1248) to 59 1/4" (1505) with accessory flue extension.