

# Use, Care, and Installation Guide

## Venezia

ZVE-E30BS  
ZVE-E36BS  
ZVE-E42BS

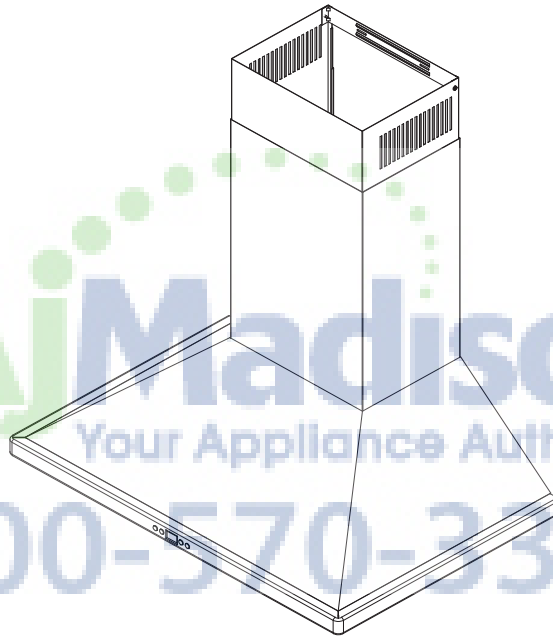

Model number: \_\_\_\_\_

Serial Number: \_\_\_\_\_



**SAFETY NOTICE** ..... 2-3

**LIST OF MATERIALS** ..... 4

**INSTALLATION**

    Ducting Calculation Sheet ..... 5

    Mounting Height & Clearance ..... 6

    Ducting Options ..... 7

    Hood Specifications ..... 8

    Mounting the Range Hood ..... 9

    Ductless Recirculating ..... 10

**FEATURES & CONTROLS**

    Touch Controls ..... 11

    User Interface ..... 12

**MAINTENANCE**

    Cleaning and Filter Care ..... 13

**TROUBLESHOOTING** ..... 14

**WIRING & FAN CURVE DIAGRAMS** ..... 15

**LIST OF PARTS AND ACCESSORIES** ..... 16

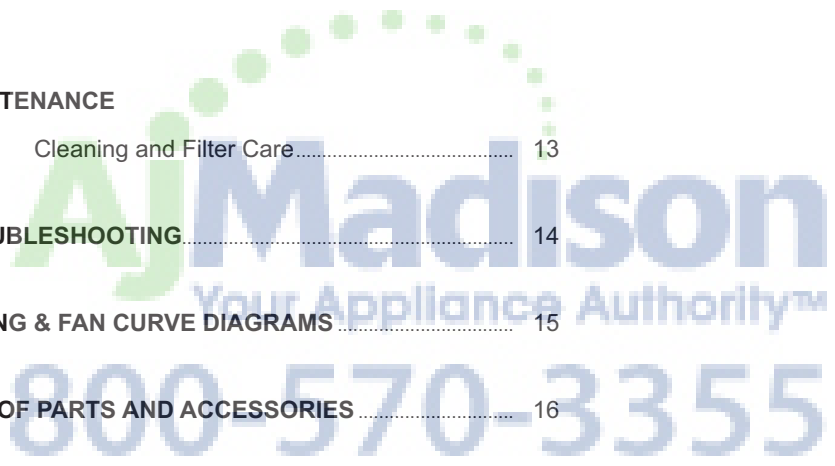

**Important Safety Notice**

**WARNING**

TO REDUCE THE RISK OF FIRE OR ELECTRIC SHOCK, DO NOT USE THIS FAN WITH ANY SOLID-STATE CONTROL DEVICE.

**WARNING**

TO REDUCE THE RISK OF FIRE ELECTRIC SHOCK, OR INJURY TO PERSONS, OBSERVE THE FOLLOWING:

- a. Use this unit only in the manner intended by the manufacturer, if you have questions, contact the manufacturer.
- b. Before servicing or cleaning unit, switch power off at service panel and lock panel to prevent power from being switched on accidentally. When the service disconnecting means cannot be locked, securely fasten a prominent warning device, such as a tag, to the service panel.

**CAUTION**

For general ventilating use only. Do not use to exhaust hazardous or explosive materials and vapors. Take care when using cleaning agents or detergents. Suitable for use in household cooking area.

**WARNING**

TO REDUCE THE RISK OF RANGE TOP GREASE FIRE:

- a. Never leave surface units unattended at high settings. Boilovers cause smoking and greasy spillovers that may ignite. Heat oils slowly on low or medium settings.
- b. Always turn hood ON when cooking at high heat or when flaming food
- c. Clean ventilating fans frequently. Grease should not be allowed to accumulate on fan or filter.
- d. Use proper pan size. Always use cookware appropriate for the size of the surface element.
- e. Keep fan, filters and grease laden surfaces clean.
- f. Use high setting on hood only when necessary.
- g. Don't leave hood unattended when cooking.
- h. Always use cookware and utensils appropriate for the type of and amount of food being prepared.

**WARNING**

TO REDUCE THE RISK OF INJURY TO PERSONS IN THE EVENT OF A RANGE TOP FIRE, OBSERVE THE FOLLOWING:

- a. SMOTHER FLAMES with a close-fitting lid, cookie sheet, or metal tray, then turn off the burner. BE CAREFUL TO PREVENT BURNS. If the flames do not go out immediately, EVACUATE AND CALL THE FIRE DEPARTMENT.
- b. NEVER PICK UP A FLAMING PAN – You may be burned.
- c. DO NOT USE WATER, including wet dishcloths or towels – a violent steam explosion will result.
- d. Use an extinguisher ONLY if:
  - 1. You know you have a Class ABC extinguisher, and you already know how to operate it.
  - 2. The fire is small and contained in the area where it started.
  - 3. The fire department is being called.
  - 4. You can fight the fire with your back to an exit

**WARNING**

TO REDUCE THE RISK OF FIRE, ELECTRIC SHOCK OR INJURY TO PERSONS, OBSERVE THE FOLLOWING:

- a. Installation work and electrical wiring must be done by qualified person(s) in accordance with all applicable codes and standards. Including fire-rated construction.
- b. Sufficient air is needed for power combustion and exhausting of gases through the flue (chimney) of fuel burning equipment to prevent back-drafting. Follow the heating equipment manufacturer's guideline and safety standards such as those published by the National Fire Protection Association (NFPA) and the American Society for Heating, Refrigeration and Air Conditioning Engineers (ASHRAE) and the local code authorities.
- c. When cutting or drilling into wall or ceiling, do not damage electrical wiring and other hidden utilities.
- d. Ducted fans must always vent to the outdoors.
- e. NEVER place a switch where it can be reached from a tub or shower.
- f. Make sure the power is off before installing, wiring or maintenancing.

**WARNING**

TO REDUCE THE RISK OF FIRE, USE ONLY METAL DUCTWORK.

**CAUTION**

To reduce risk of fire and to properly exhaust air outside - Do not vent exhaust air into spaces within walls, ceilings, attics, crawl spaces or garages.

**OPERATION**

Always leave safety grilles and filters in place. Without these components, operating blowers could catch onto hair, fingers and loose clothing.

The manufacturer declines all responsibility in the event of failure to observe the instructions given here for installation, maintenance and suitable use of the product. The manufacturer further declines all responsibility for injury due to negligence and the warranty of the unit automatically expires due to improper maintenance.

**\*NOTE: Please check [www.zephyronline.com](http://www.zephyronline.com) for revisions before doing any custom work.**

**ELECTRICAL REQUIREMENTS**

**Important:**

Observe all governing codes and ordinances.

It is the customer's responsibility:

- To contact a qualified electrical installer.
- To assure that the electrical installation is adequate and in conformance with National Electrical Code, ANSI/NFPA 70 latest edition\* or CSA standards C22.1-94, Canadian Electrical Code, Part 1 and C22.2 No.0-M91 - latest edition\*\* and all local codes and ordinances.

If codes permit and a separate ground wire is used, it is recommended that a qualified electrician determine that the ground path is adequate.

Do not ground to a gas pipe.

Check with a qualified electrician if you are not sure the range hood is properly grounded.

Do not have a fuse in the neutral or ground circuit.

\*National Fire Protection Association Batterymarch Park, Quincy, Massachusetts 02269

\*\* CSA International 8501 East Pleasant Valley Road, Cleveland, Ohio 44131-5575

This appliance requires a 120V 60Hz electrical supply and connected to an individual properly grounded branch circuit protected by a 15 or 20 ampere circuit breaker or time delay fuse. Wiring must be 2 wire with ground. Please also refer to Electrical Diagram on product.

A cable locking connector (not supplied) might also be required by local codes. Check with local requirements, purchase and install appropriate connector if necessary.

ZVE-E30BS - 212 Watts, 3.5 Amps

ZVE-E36BS - 215 Watts, 3.5 Amps

ZVE-E42BS - 215 Watts, 3.5 Amps

# List of Materials

**MODELS:** ZVE-E30BS, ZVE-E36BS, ZVE-E42BS

## PARTS SUPPLIED

- 1 - Hood with internal blower
- 3 - Aluminum mesh filters (2 for ZVE-E30BS)
- 1 - Duct cover assembly (top and bottom)
- 1 - Duct cover wall bracket
- 4 - 3W LED light bulbs (3 for ZVE-E30BS)
- 1 - 8" round backdraft damper (pre-installed)
- 1 - Hardware package

## HARDWARE PACKAGE CONTENTS

M4 x 3/8" (2)



M6 x 1-1/4" (3)

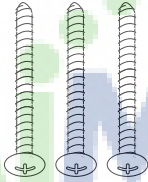

M6 x 1" (2)

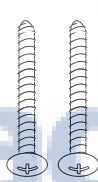



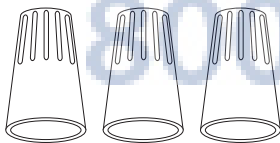





Wire Nuts (3)

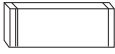

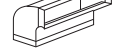

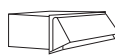







## PARTS NOT SUPPLIED

- Ducting, conduit and all installation tools
- Cable connector (if required by local codes)
- Duct cover extension accessory
- Recirculating kit accessory

# Installation – Ducting Calculation Sheet

Duct pieces		Equivalent number length x used =	Total
	3-1/4" x 10" Rect., straight	1 Ft. x ( ) =	Ft.
	7" Round, straight	1 Ft. x ( ) =	Ft.
	8" Round, straight	1 Ft. x ( ) =	Ft.
	3-1/4" x 10" Rect. 90° elbow	15 Ft. x ( ) =	Ft.
	3-1/4" x 10" Rect. 45° elbow	9 Ft. x ( ) =	Ft.
	3-1/4" x 10" Rect. 90° flat elbow	24 Ft. x ( ) =	Ft.
	3-1/4" x 10" Rect. wall cap with damper	30 Ft. x ( ) =	Ft.
	3-1/4" x 10" Rect. to 6" round transition	5 Ft. x ( ) =	Ft.
	3-1/4" x 10" Rect. to 6" round transition 90° elbow	20 Ft. x ( ) =	Ft.
	8" Round, 90° elbow	15 Ft. x ( ) =	Ft.
	8" Round, 45° elbow	9 Ft. x ( ) =	Ft.
Subtotal column 1 =			Ft.

Duct pieces		Equivalent number length x used =	Total
	6" - 8" Round wall cap with damper	30 Ft. x ( ) =	Ft.
	6" - 8" Round, roof cap	30 Ft. x ( ) =	Ft.
	6" round to 3-1/4" x 10" rect. transition	1 Ft. x ( ) =	Ft.
	6" round to 3-1/4" x 10" rect. transition 90° elbow	16 Ft. x ( ) =	Ft.
	7" or 8" Round, 90° elbow	15 Ft. x ( ) =	Ft.
	7" or 8" Round, 45° elbow	9 Ft. x ( ) =	Ft.
	7" or 8" Round wall cap with damper	30 Ft. x ( ) =	Ft.
	7" or 8" Round, roof cap	30 Ft. x ( ) =	Ft.
	7" round to 3 1/4" x 10" rect. transition	8 Ft. x ( ) =	Ft.
	7" round to 3-1/4" x 10" rect. transition 90° elbow	23 Ft. x ( ) =	Ft.
Subtotal column 2 =			Ft.
Subtotal column 1 =			Ft.
Total ductwork =			Ft.

**Maximum Duct Length:** For satisfactory air movement, the total duct length should not exceed 100 equivalent feet.

Installation – Mounting Height & Clearance

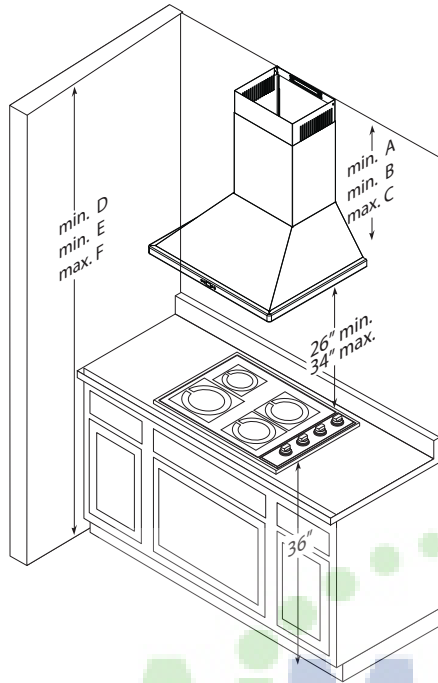

Hood Heights	Standard Duct Cover	Extension Duct Cover
minimum ducted (A)	27"	45"
minimum recirculating (B)	31-1/2"	49-1/2"
maximum (C)	44"	80"
Ceiling Heights		
minimum ducted (D)	89" (7' 5")	107" (8' 11")
minimum recirculating (E)	93-1/2" (7' 9-1/2")	111-1/2" (9' 3-1/2")
maximum (F)	114" (9' 6")	150" (12' 6")

**DUCTING**

A minimum of 8" round duct is recommended to maintain maximum air flow efficiency.

Always use rigid type metal ducts only. Flexible ducts could restrict air flow by up to 50%.

Use calculation worksheet on page 5 to compute total duct work.

ALWAYS, when possible, reduce the number of transitions and turns. If a long duct run is required, increase duct size from 8" to 10".

If turns or transitions are required: Install as far away from opening and as far apart, between 2, as possible.

Minimum mount height between range top to hood bottom should be no less than 26".

Maximum mount height should be no higher than 34".

It is important to install the hood at the proper mounting height. Hoods mounted too low could result in heat damage and fire hazard; while hoods mounted too high will be hard to reach and will lose its performance and efficiency.

If available, also refer to range manufacturer's height clearance requirements and recommended hood mounting height above range. Always check your local codes for any differences.

Duct cover extension kit available for ceiling heights up to 12 feet. Turn to page 16 for part number and ordering information.

**DAMAGE-SHIPMENT / INSTALLATION:**

- Please fully inspect unit for damage before installation.
- If the unit is damaged in shipment, return the unit to the store in which it was bought for repair or replacement.
- If the unit is damaged by the customer, repair or replacement is the responsibility of the customer.
- If the unit is damaged by the installer (if other than the customer), repair or replacement must be made by arrangement between customer and installer.



**WARNING FIRE HAZARD**

NEVER exhaust air or terminate duct work into spaces between walls, crawl spaces, ceiling, attics or garages. All exhaust must be ducted to the outside, unless using the recirculating option.

Use single wall rigid Metal ductwork only.

Fasten all connections with sheet metal screws and tape all joints w/ certified Silver Tape or Duct Tape.

**Some Ducting Options**

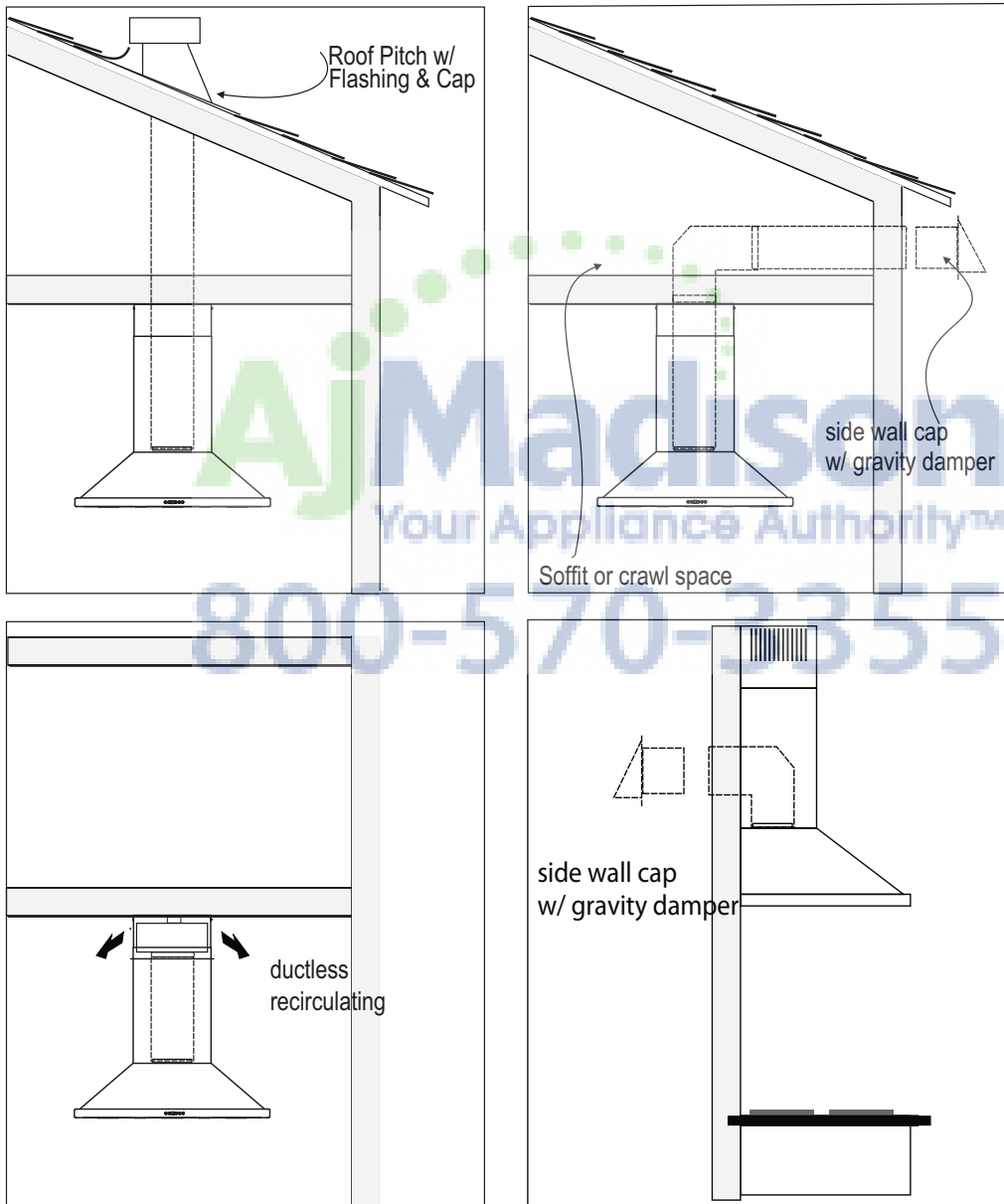

# Installation – Hood Specifications

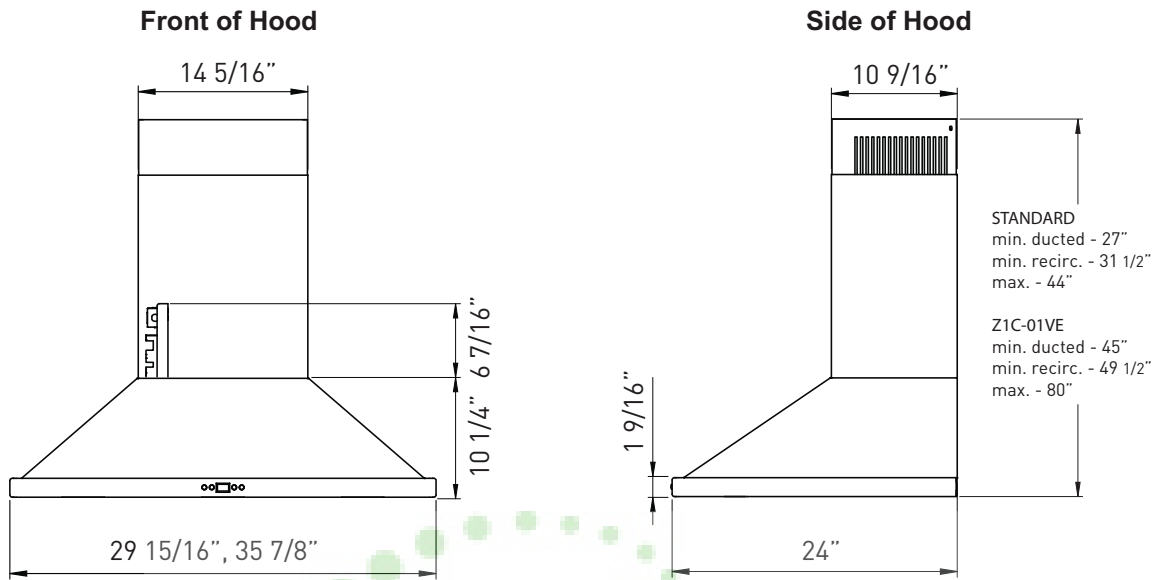

**AjMadison**  
Your Appliance Authority™

800-570-3355

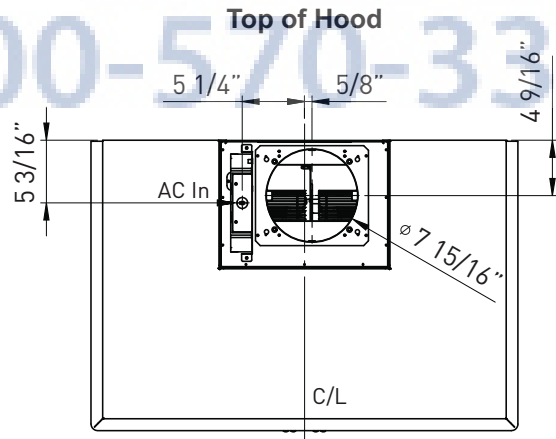

**⚠ CAUTION:** At least two installers are required due to the weight and size of the hood.

1. Measure from range top to hood bottom and mark line A. (26" minimum from range top).
2. Plum and mark center line.
3. Mark mounting height line B. (10-1/4" from line A)
4. Mark mounting spread from C/L on line B. (9-7/16")
5. Fasten (2) M6 x 1-1/4" screws into studs on line B. Do not fasten screws all the way. **note: wood blocking may need to be added behind the drywall if no studs are present. Wall anchors may also be used, check local codes before using wall anchors.**
6. Hang hood onto screws and hand tighten. (FIG. A #1) Use the last M6 x 1-1/4" screw to further secure the hood to the wall from inside the hood.
7. Center and attach duct cover bracket to wall below ceiling or soffit using (2) M6 x 1" screws.
8. Remove tape securing electronics mounting bracket to hood. Reposition electronics mounting bracket to hood and secure by two pre-installed screws as shown in (FIG. B #1).
9. Install electrical.
10. \*Install duct work and duct tape.
11. Power up hood and check for leaks around duct tape.
12. Place telescopic duct covers onto hood and extend inner (top) duct cover upwards and secure to duct cover bracket using (2) M4x3/8" screws.

\*If using hood in recirculating mode you must secure air diverter plate onto wall before installing duct work and duct covers. Turn to page 10 for more details.

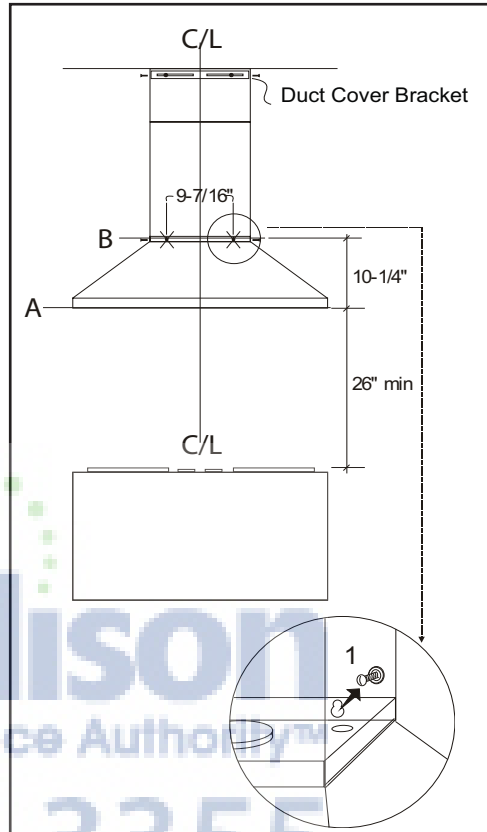

FIG. A

**⚠ WARNING:** Electrical wiring must be done by a qualified person(s) in accordance with all applicable codes and standards. This range hood must be properly grounded. Turn off electrical power at service entrance before wiring.

### Cable Lock

A cable locking connector (not supplied) might be required by local codes. Check with local requirements and codes, purchase and install appropriate connector if necessary.

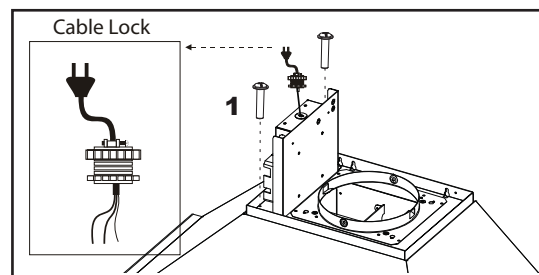

FIG. B

Ductless recirculating is intended for applications where an exhaust duct work is not possible to be installed. When converted, the hood functions as a recirculating hood rather than an exhaust hood. Fumes and exhaust from cooking are drawn and filtered by a set of optional charcoal filters. The air is then purified and re-circulated back within the home.

We recommend to ALWAYS exhaust air outside of the home by employing existing or installing new duct work, if possible. The hood is most effective and efficient as an exhaust hood. Only when the exhaust option is not possible should you recourse to converting the hood into a recirculating hood.

When converted to be a recirculating hood, a set of charcoal filters are required on top of its standard Aluminum Mesh Filter set. Order according to its Part number below. The standard Aluminum Mesh Filters are intended to capture residue from cooking and the optional charcoal filters help to purify fumes exhausted from cooking for re-circulation.

### RECIRCULATING KIT (REQUIRED IF NO DUCTING IS USED)

Kit includes charcoal filters and air diverter plate.

Hood Model	Part No.	Filters in Pkg.
ZVE-E30BS	ZRC-00VE	2
ZVE-E36BS/E42BS	ZRC-01VE	3

1. Secure air diverter plate to wall below duct cover wall bracket. (FIG.C)
2. Remove aluminum mesh filters from hood. Install charcoal filter brackets inside filter opening. Note: screws to secure charcoal filter bracket are already pre-installed in the hood and must first be removed.
3. Clip charcoal filters onto charcoal filter bracket. (FIG. C)
4. Re-install aluminum mesh filters.
5. Turn on charcoal filter change indicator on control panel. (refer to details on page 12.) The microprocessor in the controls will indicate the need to change the charcoal filters after 120 hours of continuous use. Order replacement charcoal filters per the list below.

NOTE: See manual included with recirculating kit for more detailed instructions.

### Charcoal Filter Replacements

Hood Model	Part No.	Qty to Order
ZVE-E30BS	Z0F-C002	2
ZVE-E36BS/E42BS	Z0F-C002	3

DO NOT WASH CHARCOAL FILTERS. Charcoal filters may need to be changed more often depending on cooking habits.

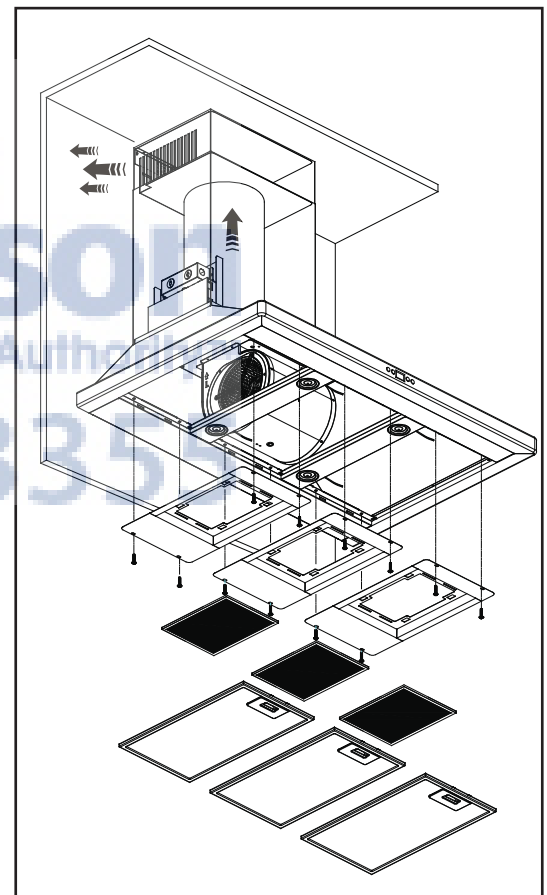
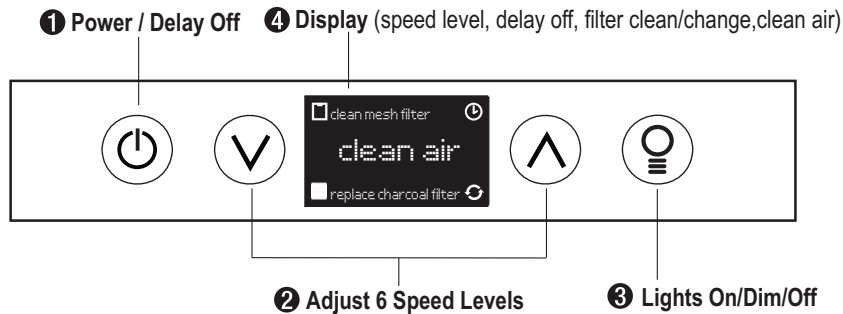





FIG. C





### 1 Power / Delay Off Button

#### Power Button Function

-  Button will turn power on and off for entire hood (fan and lights).
- Hood will remember the last speed and light level it was turned off at.  
(Example: Press  Button to turn off hood when on fan speed 4 and high lights. Press  Button again and the hood will turn back on at speed 4 and high lights level.)

#### Delay Off Button Function

- Press and hold  Button for two seconds and the fan will turn on speed 1. The  Graphic will illuminate. After five minutes the fan and lights will automatically turn off.
- Pressing  Button while Delay Off Function is enabled will turn the hood off and cancel the Delay Off Function.

### 2 Speed Selection Button

#### Fan Speed Decrease Button

- Press this button to decrease fan speed. 6 (burst), 5, 4, 3, 2, 1.
- If fan is On Speed 1 and this button is pressed, fan will power Off.

#### Fan Speed Increase Button

- Press this button to increase fan speed. Fan On, 1, 2, 3, 4, 5, 6 (burst).
- If hood is Off and this button is pressed, fan will turn On Speed 1.



#### Burst Mode

- This speed level is intended to be used as a quick burst of air extraction when excess cooking fumes and smoke are generated. After 3 minutes the fan will automatically change to Speed 5.









### 3 Lights Button

- Lights are two levels, High and Low.
- From off, press one time for High. LCD will show the words "lights hi" for 2 seconds then fade away.
- Press again for Low. LCD will display the words "lights lo" for 2 seconds then fade away.
- Press again to power lights off.









### **Mesh Filter Clean Indicator** *(always enabled)*

- After 30 hours of fan usage the  Graphic and words “clean mesh filter” will illuminate indicating it is time to clean the mesh filters. Graphic and words will remain illuminated until reset.
- **To reset:** With hood off, hold the  Button for three seconds, after three seconds the  Graphic and words “clean mesh filter” will turn off and the 30 hour timer will reset.

### **Charcoal Filter Replace Indicator** *(disabled by default, must be enabled if recirculating hood)*

- To enable Charcoal Filter Replacement Function:
  - With hood off, hold  Button and  Button simultaneously for three seconds. The  Graphic will illuminate for three seconds indicating the Charcoal Filter Replacement Function is enabled.
- To disable Charcoal Filter Replacement Function:
  - With hood off, hold  Button and  Button simultaneously for three seconds. The  Graphic will be illuminated then turn off indicating the Charcoal Filter Replacement Function is disabled.
- After 120 hours of fan usage the  Graphic and words “replace charcoal filter” will illuminate indicating it is time to replace the charcoal filter. *Graphic and words will remain illuminated until reset.*
- **To reset:** With hood off, hold the  Button for three seconds, after three seconds the  Graphic and words “replace charcoal filter” will turn off and the 120 hour timer will reset.

### **Clean Air Indicator**

- Clean Air is a feature that turns the fan on every 4 hours for 10 minutes to remove stagnant air in the kitchen.
  - To enable Clean Air Function:
    - With hood off, hold the  Button and  Button simultaneously for three seconds. The  Graphic and words “clean air” will illuminate and the fan will turn on speed 1 for 10 minutes. After 10 minutes the fan will turn off and the 4 hour timer will begin.
    -  Graphic will remain on when Clean Air Function is enabled, even if fan is not on.
  - To disable Clean Air Function:
    - With hood off, hold the  Button and  Button simultaneously for three seconds until  Graphic turns off.
- When the Clean Air Function is enabled the fan will turn on speed 1 for 10 minutes every 4 hours of non fan usage. After 10 minutes the fan will turn off and the 4 hour timer will reset.
- If the user changes the fan speed while the Clean Air Function is in use, the words “clean air” will turn off but the  Graphic will remain illuminated. If the user presses the  Button at any time the 4 hour clean air timer will reset.

**SURFACE MAINTENANCE:**

Clean the hood surface periodically with hot soapy water and clean cotton cloth. Do not use corrosive or abrasive detergent, or steel wool/scouring pads which will scratch and damage surface.

For heavier soil use liquid degreaser.

After cleaning it is recommended that you use non-abrasive stainless steel polish/cleaners, to polish and buff out the stainless luster and grain. Always scrub lightly, with clean cotton cloth, and with the grain.

Do not use any product containing chlorine bleach. Do not use “orange” cleaners.

**Aluminum Mesh Filters**

The aluminum mesh filters installed by the factory are intended to filter out residue and grease from cooking. They need not be replaced on a regular basis but are required to be kept clean.

After 30 hours of use the words “clean mesh filter” will illuminate on the control screen indicating time to clean the aluminum mesh filters. Refer to instructions on page 12 on how to reset the indicator. Filters may need to be cleaned more depending on cooking habits.

Remove and clean by hand or in dishwasher on low heat. Spray degreasing detergent and leave to soak if heavily soiled.

Dry filters and re-install before using hood.

**Removing Aluminum Mesh Filters**

1. Push in on spring loaded handle
2. Pull down on filter handle to remove filter

Should filters wear out due to age and prolonged use, replace with following part number:

Hood Model:	Part No.	Qty. to Order.
ZVE-E30BS	50200027	2
ZVE-E36BS/E42BS	50200027	3

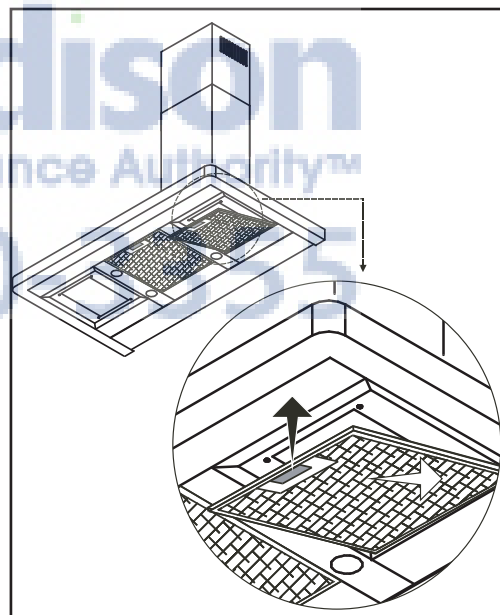

# Troubleshooting

## TROUBLESHOOTING PROCEDURES FOR VENEZIA

Issue	Cause	What to do
After installation, the unit doesn't work.	1. The power source is not turned ON.	1. Make sure the circuit breaker and the unit's power is ON.
	2. The power line and the cable locking connector is not connecting properly.	2. Check the power connection with the unit is connected properly.
	3. The switch board and control board wirings are disconnected.	3. Make sure the wirings between the switch board and control board are connected properly.
	4. The switch board or control board is defective.	4. Change the switch board or control board.
Light works, but motor is not turning.	1. The motor is defective, possibly seized.	1. Change the motor.
	2. The thermally protected system detects if the motor is too hot to operate and shuts the motor down.	2. The motor will function properly after the thermally protected system cool down.
	3. The switch board or control board is defective.	3. Change defective part.
The unit is vibrating.	1. The motor is not secure in place.	1. Tighten the motor in place.
	2. Damaged blower wheel.	2. Replace the blower.
	3. The hood is not secured in place.	3. Check the installation of the hood.
	4. The switch board or control board is defective.	4. Change defective part.
The motor is working, but the lights are not.	1. Defective LED bulb.	1. Change the LED bulb.
	2. The LED bulb plug is disconnected.	2. Connect the LED bulb plug.
The hood is not venting out properly.	1. The hood might be hanging too high from the cook top.	1. Adjust the distance between the cook top and the bottom of the hood within 26" and 34" range.
	2. The wind from the opened windows or opened doors in the surrounding area are affecting the ventilation of the hood.	2. Close all the windows and doors to eliminate the outside wind flow.
	3. Blockage in the duct opening or ductwork.	3. Remove all the blocking from the duct work or duct opening.
	4. The direction of duct opening is against the wind.	4. Adjust the duct opening direction.
	5. Using the wrong size of ducting.	5. Change the ducting to at least 8" or higher for the internal blower.
Metal Filter is vibrating.	1. Metal filter is loose.	1. Change the metal filter.

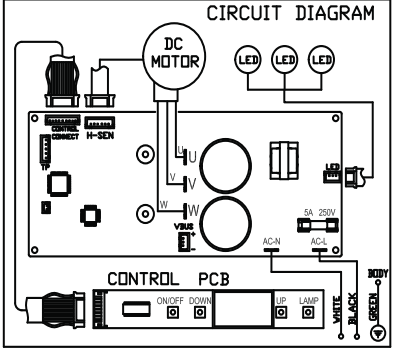

Model: ZVE-E30BS Voltage: 120V 60Hz Power consumption Total: Max. 212W @ 3.5A Lamp: Max. 3Wx3 Fan: Max. 203W THERMALLY PROTECTED	<b>CIRCUIT DIAGRAM</b> 
--	--

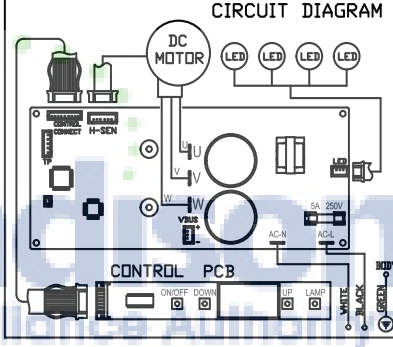
Model: ZVE-E36.42BS Voltage: 120V 60Hz Power consumption Total: Max. 215W @ 3.5A Lamp: Max. 3Wx4 Fan: Max. 203W THERMALLY PROTECTED	<b>CIRCUIT DIAGRAM</b> 
---	---

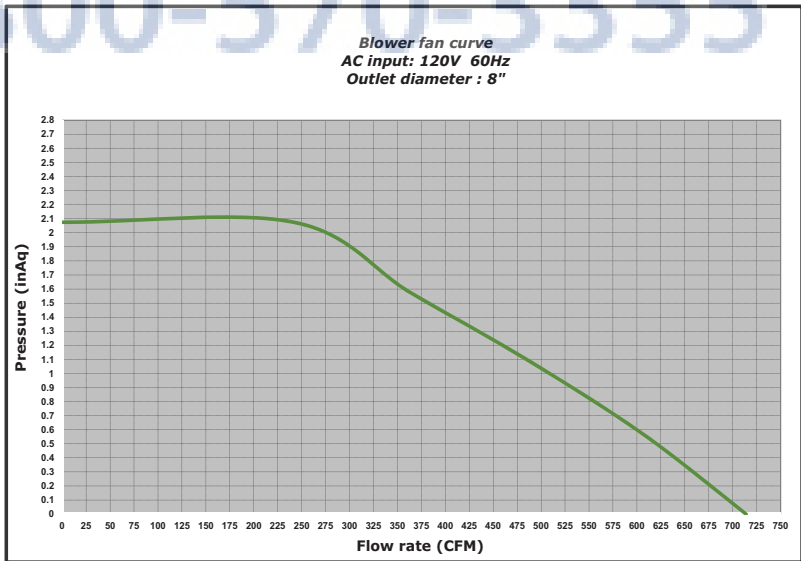

**List of Materials**

<b>DESCRIPTION</b>	<b>PART#</b>
<b>Replacement Parts</b>	
Metal Mesh Filter (each)	50200027
LED 3W Light bulb (each)	Z0B-0032
<b>Optional Accessories</b>	
Recirculating Kit, ZVE-E30BS	ZRC-00VE
Recirculating Kit, ZVE-E36BS/E42BS	ZRC-01VE
Replacement Charcoal Filter (each)	Z0F-C002
Duct Cover Extension Kit	Z1C-01VE

To order parts, visit us online at <http://store.zephyronline.com> or call us at 1.888.880.8368



ESSENTIALS  
**ZEPHYR**  
Limited Warranty

**STAPLE YOUR RECEIPT HERE**  
**Proof of the original purchase**  
**date is needed to obtain**  
**service under warranty**

**TO OBTAIN SERVICE UNDER WARRANTY OR FOR ANY SERVICE RELATED QUESTIONS, please call:**  
**1-888-880-8368**

Zephyr Corporation (referred to herein as “we” or “us”) warrants to the original consumer purchaser (referred to herein as “you” or “your”) of Zephyr products (the “Products”) that such Products will be free from defects in materials or workmanship as follows:

**Three Year Limited Warranty for Parts and LED lamps:** For three years from the date of your original purchase of the Products, we will provide, free of charge, Products or parts to replace those that failed due to manufacturing defects. We may choose, in our sole discretion, to repair or replace parts before we elect to replace the Products.

**One Year Limited Warranty for Labor:** For one year from the date of your original purchase of the Products, we will provide, free of charge, the labor cost associated with repairing the Products or parts to replace those that failed due to manufacturing defects. After the first year from the date of your original purchase, you are responsible for all labor costs associated with this warranty.

**Warranty Exclusions:** This warranty covers only repair or replacement, at our option, of defective Products or parts and does not cover any other costs related to the Products including but not limited to: (a) normal maintenance and service required for the Products and consumable parts such as metal and carbon filters and fuses; (b) any Products or parts which have been subject to freight damage, misuse, negligence, accident, faulty installation or installation contrary to recommended installation instructions, improper maintenance or repair (other than by us); (c) commercial use of the Products or use otherwise inconsistent with its intended purpose; (d) natural wear of the finish of the Products or wear caused by improper maintenance, use of corrosive and abrasive cleaning products, pads, and oven cleaner products; (e) chips, dents or cracks caused by abuse or misuse of the Products; (f) service trips to your home to teach you how to use the Products; or (g) damage to the Products caused by accident, fire, floods or act of God. If you are outside our service area, additional charges may apply for shipping costs for warranty repair at our designated service locations and for the travel cost to have a service technician come to your home to repair, remove or reinstall the Products. After the first year from the date of your original purchase, you are also responsible for all labor costs associated with this warranty.

**Limitations of Warranty. OUR OBLIGATION TO REPAIR OR REPLACE, AT OUR OPTION, SHALL BE YOUR SOLE AND EXCLUSIVE REMEDY UNDER THIS WARRANTY. WE SHALL NOT BE LIABLE FOR INCIDENTAL, CONSEQUENTIAL OR SPECIAL DAMAGES ARISING OUT OF OR IN CONNECTION WITH THE USE OR PERFORMANCE OF THE PRODUCTS. THE EXPRESS WARRANTIES IN THE PRECEDING SECTION ARE EXCLUSIVE AND IN LIEU OF ALL OTHER EXPRESS WARRANTIES. WE HEREBY DISCLAIM AND EXCLUDE ALL OTHER EXPRESS WARRANTIES FOR THE PRODUCTS, AND DISCLAIM AND EXCLUDE ALL WARRANTIES IMPLIED BY LAW, INCLUDING THOSE OF MERCHANTABILITY AND FITNESS FOR A PARTICULAR PURPOSE.** Some states or provinces do not allow limitations on the duration of an implied warranty or the exclusion or limitation of incidental or consequential damages, so the above limitations or exclusions may not apply to you. To the extent that applicable law prohibits the exclusion of implied warranties, the duration of any applicable implied warranty is limited to the same two-year period described above. Any oral or written description of the Products is for the sole purpose of identifying the Products and shall not be construed as an express warranty. Prior to using, implementing or permitting use of the Products, you shall determine the suitability of the Products for the intended use, and you shall assume all risk and liability whatsoever in connection with such determination. We reserve the right to use functionally equivalent refurbished or reconditioned parts or Products as warranty replacements or as part of warranty service. This warranty is not transferable from the original purchaser and applies in the United States and Canada.

**To Obtain Service Under Limited Warranty:** To qualify for warranty service, you must: (a) notify us at the address or telephone number stated below within 60 days of the discovery of the defect; (b) give the model number and part identification number and serial number; and (c) describe the nature of any defect in the Product or part. At the time of the request for warranty service, you must present evidence of your proof of purchase and proof of the original purchase date. If we determine that the warranty exclusions listed above apply or if you fail to provide the necessary documentation to obtain service, you will be responsible for all shipping, travel, labor and other costs related to the services.

Please check our website for any revisions, [www.zephyronline.com](http://www.zephyronline.com).

**Zephyr Corporation Service Department, 2277 Harbor Bay Parkway, Alameda, CA 94502 1-888-880-8368**