

PE304HB

30" BUILT-IN INDUCTION COOKTOP WITH CONCEALED CENTRIC DIGITAL TOUCH CONTROL SLIDER INTERFACE

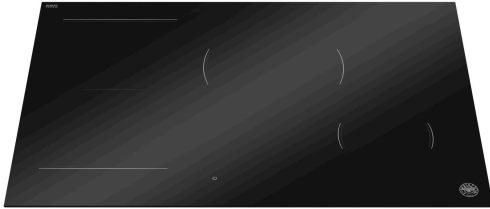

The Future of Cooking

Combining precision engineering, refined Italian craftsmanship, and innovative technology, Bertazzoni induction cooktops redefine the cooking experience. With their outstanding performance and sophisticated design, they transform everyday meals into effortless and enjoyable culinary moments.

Distinctive Italian Design

The concealed user interfaces and minimal serigraphies contribute to a clean and refined aesthetic, blending seamlessly into modern kitchen environments. When the cooktop is powered off, the interface remains completely invisible, preserving the minimalist design. When activated, the white slider control provide an intuitive and sophisticated user experience.

Unmatched Cooking Performances

The Flexi-Zone Technology enhances cooking flexibility by linking adjacent cooking zones, enabling the use of larger cookware or griddles while maintaining uniform heat distribution. The octagonal induction elements optimize energy efficiency and eliminate hot spots, delivering consistently superior results for every dish.

Grill: Precision Meets Flavor

Turn your induction cooktop into a true grilling station. With the dedicated Grill function and the versatile griddle accessory, you can achieve perfectly seared meats, golden vegetables, and flawless pancakes, all with the precision and ease of induction cooking.

PRODUCT FEATURES

Product type	30" Induction cooktop with 4 induction zones
User interface	Concealed Digital Slider with white led
Numbers of zones	4 induction zones
Heating zone power	Front Left 7 1/2 x 8 1/4 - 2100W (3000 W) Back Left 7 1/2 x 8 1/4 - 2100W (3000 W) Center Ø 9 13/16 - 2300W (3000 W) Front Right Ø 5 11/16 - 1400W (1850 W)
Booster	yes
Multi-zone	1 Multi-zone
Grill	yes
Timer	yes
Pause and Recal	yes
Child lock	yes
Residual heat indicator	yes

TECHNICAL SPECIFICATIONS

Electrical supply	208 V - 60 HZ / 240 V - 60 HZ 7400 W 32 Amp
Power connection	Metal conduit with 71" power cord
Certification	UL
Warranty	2 years parts & labor
Product dimensions and net weight	W: 30 3/4" H: 2 1/2" D: 20 1/2" 31 lbs
Cut-out dimensions	W: 29 3/8" H: 2 3/4" D: 18 3/4"
Packaging dimensions and gross weight	W: 37 1/4" H: 6 19/64" D: 26 3/16" 37 lbs

ACCESSORY

GR22ICI	Cast iron griddle for induction
---------	---------------------------------

PE304HB

30" BUILT-IN INDUCTION COOKTOP WITH CONCEALED CENTRIC DIGITAL TOUCH CONTROL SLIDER INTERFACE



PRODUCT DIMENSIONS

TOP VIEW

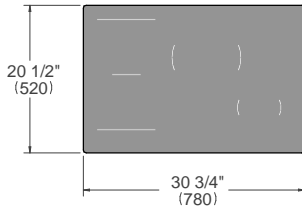

FRONT VIEW

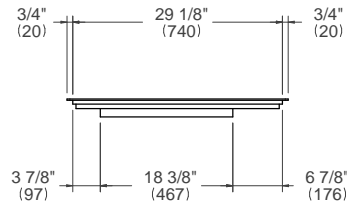

SIDE VIEW

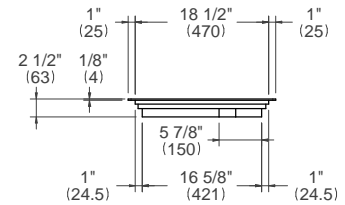

ELECTRICAL & GAS CONNECTION

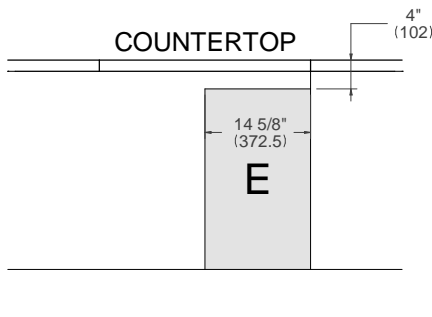

E A properly-grounded, horizontally-mounted electrical receptacle should be installed according this drawing.

INSTALLATION REQUIREMENTS

Combustible material cannot be located within shaded area above countertop.

CUTOUT DIMENSIONS

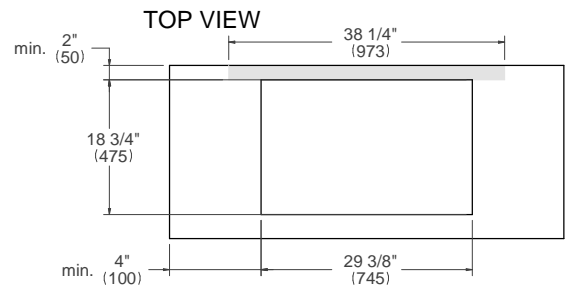

SIDE VIEW

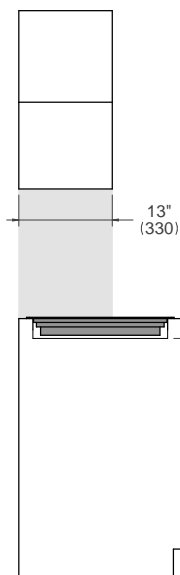

FRONT VIEW

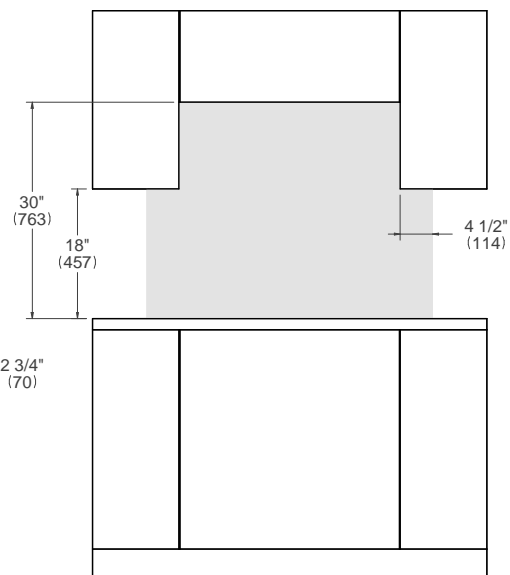

For installation of multiple products in combination, refer to the Design Guide at us.bertazzoni.com or ca.bertazzoni.com

Disclaimer: while every effort has been made to ensure the accuracy of the information contained in this document, Fratelli Bertazzoni reserves the right to change it at any time without notice. For detailed installation instructions, consult the installation manual. Fratelli Bertazzoni, Bertazzoni and the winged wheel brand icon are registered trademarks of Bertazzoni Spa.