

PB975SM

GE Profile™ 30" Free-Standing Double Oven Range

Dimensions and Installation Information (in inches)

KW Rating	
240V	14.3
208V	10.7
Breaker Size	
40 Amps†	

†**Note:** Check local codes for required breaker size.

Effective January 1, 1996, the National Electrical Code requires that new construction (not existing) utilize a 4-conductor connection to an electric range.

Receptacle Locations: Locally approved flexible service cord or conduit must be used because terminals are not accessible after range installation. See shaded area in drawing for location of electrical outlet box. Recommended outlet locations allow range to be installed directly against wall.

Note: 30" ranges conform to U.L. requirements for 0" spacing from adjacent walls below countertops. To reduce possibility of scorching walls, engineering recommends a minimum of 1-1/2" spacing to allow for possible extended, high-heat, no-load heating element operation.

Installation Information: Before installing, consult installation instructions packed with product for current dimensional data.

For answers to your Monogram®, GE Profile™ or GE® appliance questions, visit our website at ge.com or call GE Answer Center® service, 800.626.2000.

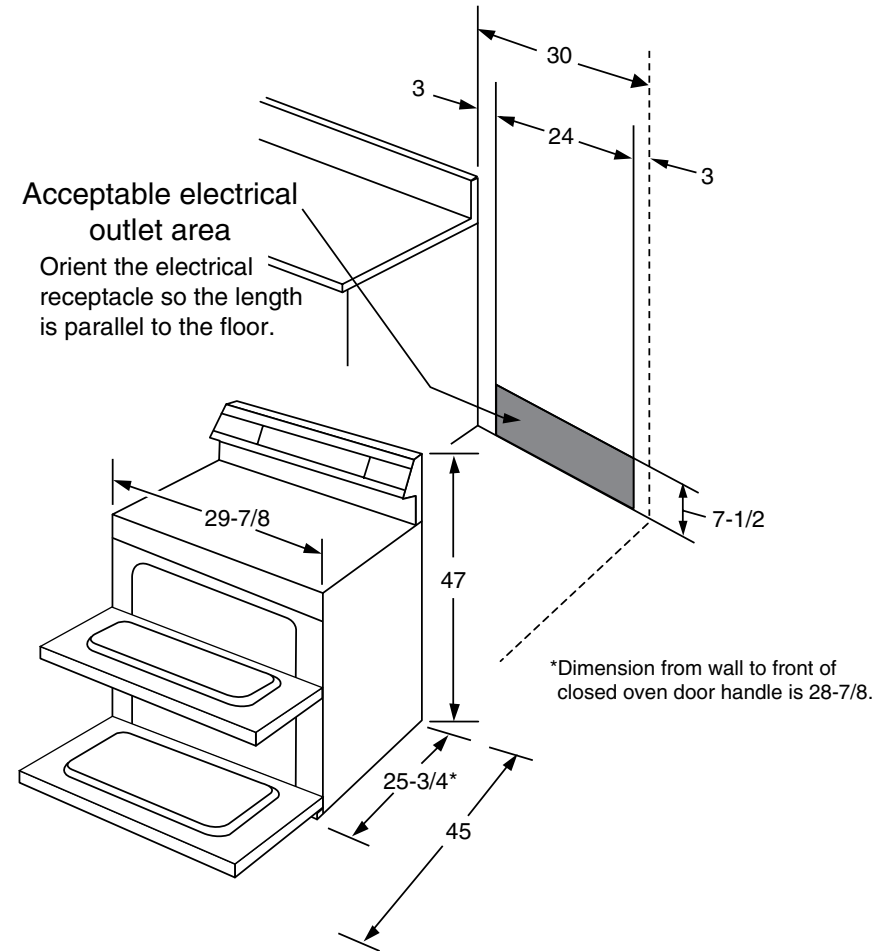

All GE ranges are equipped with an Anti-Tip device. The installation of this device is an important, required step in the installation of the range.



Listed by Underwriters Laboratories

PB975SM

GE Profile™ 30" Free-Standing Double Oven Range

Features and Benefits

- Upper Oven - With an additional 2.2 cu. ft. of capacity, the upper oven is perfect for preparing food items at the same time as the lower oven
- PreciseAir™ Convection System - Delivers even air and heat circulation for superior baking and roasting results
- Tri-ring Burner - 12"/9"/6" heating element offers a convenient choice for various size pans
- Bridge Element - Combines three cooktop elements into one large cooking area, ideal for oversized cooking pans
- Large 4.4 Cu. Ft. Lower Oven Capacity - Provides an impressively large oven interior to cook more dishes and large meals at once
- Self-Clean Oven - Conveniently cleans the oven cavity without need of scrubbing
- Warming Zone - Provides low heat capability for foods, making meal coordination simple
- Single/Multi-Rack Convection Bake - Provides ideal airflow throughout the oven, ensuring optimal results on both racks
- Convection Roast - Provides even cooking and consistent results, roasting meats faster than a traditional oven
- Slow Cook - Offers four slow cook options-pork, poultry, beef and stew-to deliver ideal conditions for specific meals
- Pizza Mode - Provides ideal cooking conditions for preparing fresh or frozen pizzas at the touch of a button
- Self-Clean Heavy-Duty Oven Racks - Double coated porcelain-enameled racks no longer require hand cleaning
- 6.6 Cu. Ft. Total Capacity - Provides plenty of room to cook the biggest of meals, 4.4 cu. ft. in the lower oven and 2.2 cu. ft. in the upper oven
- Model PB975SMSS - Stainless steel (black patterned cooktop)



imagination at work