

Operating Instructions

Dishwasher



To prevent accidents and machine damage, read these instructions before installation or use.

Contents

IMPORTANT SAFETY INSTRUCTIONS	5
Guide to the dishwasher	15
Appliance overview	15
Control panel.....	16
Display functions	17
Caring for the environment	18
Energy-saving dishwashing.....	19
Before using for the first time	20
Opening the door	20
Closing the door.....	21
Child lock.....	21
Basic settings	22
Before using the appliance for the first time, you require:	24
Dishwasher salt	24
Filling the salt reservoir.....	25
Salt refill indicator	26
Rinse aid.....	27
Adding rinse aid	27
Rinse aid indicator.....	28
Loading the dishwasher	29
Tips.....	29
Loading examples	31
FlexAssist	35
Upper basket.....	35
Adjusting the upper basket	38
Lower basket.....	39
Pot rests and filters.....	42
Cutlery	44
3D cutlery tray+ (depending on model).....	44
Operation	46
Detergent.....	46
Turning on.....	49
Selecting a program	49
Starting a program	50
Time display	50
Energy management	51
At the end of the program	51
Turning off the dishwasher	52
Unloading the dishwasher.....	52

Interrupting a program.....	53
Changing a program.....	53
Options	54
Options	54
Delay Start with EcoStart	56
EcoTech Heat exchanger	59
Program overview	60
Settings menu	64
Opening the Settings menu.....	64
Language 	64
Time of day.....	65
Date	65
Water hardness	66
Rinse aid.....	67
EcoStart.....	67
Networking	69
Miele@home	69
Changing the main menu	72
Saving options.....	72
System lock.....	73
Temperature	73
Brightness	73
Volume.....	74
Memory	75
Check filters	75
SensorWash	75
AutoOpen	76
BrilliantLight.....	76
EcoTech Heat exchanger	76
Software version.....	77
Showroom program.....	77
Factory default settings.....	77
Closing the Settings menu	77
Cleaning and care	78
Cleaning the wash cabinet	78
Cleaning the door and the door seal	78
Cleaning the door front	79
Filter system	80
Cleaning the spray arms.....	82

Contents

Frequently Asked Questions	83
Technical problems	83
Water intake fault.....	86
Water drainage fault	87
General problems.....	88
Noises.....	89
Poor cleaning results.....	90
Frequently asked questions	93
Cleaning the drain pump and non-return valve.....	93
Customer service	94
Repairs	94
Warranty	94
Optional accessories	95
Miele@home	97
Installation Instructions	99
Electrical connection	100
Water connection	102
Water intake	102
Drainage	103
Sound emission testing	104

IMPORTANT SAFETY INSTRUCTIONS

This dishwasher complies with current safety requirements. Inappropriate use can, however, lead to personal injury and damage to property.

To avoid the risk of accidents and damage to the dishwasher, please read the installation plan and the operating instructions carefully before it is installed and used for the first time. Both contain important information on its installation, safety, use and maintenance.

Keep the installation plan and the operating instructions in a safe place and pass them on to any future owner.

Miele cannot be held liable for damage caused by non-compliance with this information.

IMPORTANT SAFETY INSTRUCTIONS

Correct use

- ▶ This dishwasher is intended for use in domestic households and similar residential environments.
- ▶ This dishwasher is not suitable for outdoor use.
- ▶ It must only be used as specified in these operating instructions for cleaning domestic dishes and cutlery. Any other usage is not supported by the manufacturer and could be dangerous.
- ▶ This appliance is not intended for use by persons (including children) with reduced physical, sensory or mental capabilities, or lack of experience and knowledge.

IMPORTANT SAFETY INSTRUCTIONS

Safety with children

- ▶ Children must be kept away from the appliance unless they are constantly supervised.
- ▶ Children should be supervised to ensure that they do not play with the appliance. Keep small children away from the appliance at all times to avoid the risk of injury. There is the risk that children may lock themselves in the dishwasher.
- ▶ If the automatic door opening mechanism (depending on model) is active keep young children away from the area in which the door opens. Danger of injury in the unlikely event of a fault with the opening mechanism.
- ▶ Danger of suffocation! Ensure that any plastic wrappings, bags, etc. are disposed of safely and kept out of the reach of children.
- ▶ Keep children away from detergents. Dishwasher detergents can cause burning in the mouth, nose and throat if swallowed, or inhibit breathing. Keep children away from the dishwasher when the door is open. There could still be detergent residues in the cabinet. Seek medical attention immediately if your child has swallowed or inhaled detergent.

IMPORTANT SAFETY INSTRUCTIONS

Technical safety

- ▶ Installation, repair, and maintenance work should only be performed by a Miele-authorized service technician. Work by unqualified persons could be dangerous and may void the warranty.
- ▶ Before installation, check the dishwasher for visible signs of damage. Under no circumstances should you use a damaged dishwasher. A damaged dishwasher could be dangerous.
- ▶ The electrical safety of this appliance can only be guaranteed when continuity is complete between it and an effective grounding system. It is most important that this basic safety requirement is present and regularly tested and, where there is any doubt, the electrical system in the house should be checked by a qualified electrician.
Miele cannot be held liable for the consequences of an inadequate grounding system (e.g. electric shock).
- ▶ Reliable and safe operation of this dishwasher can only be assured if it has been connected to the electrical supply.
- ▶ If the dishwasher is plugged into the electricity supply using a 3-pin plug with a grounding contact (it must not be hard-wired), the electrical socket must be easily accessible after the dishwasher is installed so that it can be disconnected from the electrical supply at any time.
- ▶ There must be no electrical sockets behind the dishwasher. There is a danger of overheating and fire risk if the dishwasher is pushed up against a plug.
- ▶ The dishwasher must not be installed under a cooktop. The high radiant temperatures which are sometimes generated by a cooktop could damage the dishwasher. For the same reason, it should not be installed next to open fires or other appliances which give off heat, such as heaters, etc.

IMPORTANT SAFETY INSTRUCTIONS

- ▶ To avoid the risk of damage to the dishwasher, make sure that the connection data on the data plate (fuse rating, voltage, and frequency) matches the electrical supply before connecting the dishwasher to the mains. Consult a qualified electrician if in any doubt.
- ▶ Do not connect the dishwasher to the electrical supply until it has been fully installed and any adjustment has been made to the door springs.
- ▶ Do not connect the appliance to the electrical supply by a multi-socket adapter or an extension lead. These do not guarantee the required safety of the appliance (e.g. danger of overheating).
- ▶ The dishwasher may only be operated if the door opening mechanism is working correctly. Otherwise there could be a risk of danger while the automatic door opening mechanism (depending on model) is active.
To check that the door opening mechanism is working correctly:
 - The door springs must be adjusted equally on both sides. They are correctly adjusted when the door remains stationary when left half open (approx. 45° opening angle). It is also important that the door cannot fall open.
 - The door locking pins automatically retract when the door opens at the end of the drying phase.
- ▶ This appliance must not be installed and operated in a non-stationary location (e.g., on a ship).
- ▶ Do not install the dishwasher in a room where there is a risk of frost. Frozen hoses may burst or split. The reliability of the electronic module may be impaired at temperatures below freezing point.
- ▶ To avoid any damage to the appliance, the dishwasher must only be operated when it is connected to a fully vented plumbing system.
- ▶ The water pressure (flow pressure at the connection point) must be between 7.25 - 145 psi.

IMPORTANT SAFETY INSTRUCTIONS

- ▶ A damaged appliance could be dangerous. If the dishwasher gets damaged, turn off the electrical supply and contact Miele.
- ▶ The manufacturer's warranty will be invalidated if the appliance is not repaired by a Miele-authorized service technician.
- ▶ Defective components should be replaced by Miele original parts only. Only with these parts can the manufacturer guarantee the safety of the appliance.
- ▶ During installation, maintenance and repair work, the appliance must be disconnected from the electrical supply (turn it off and withdraw the plug from the socket).
- ▶ If the connection cable is damaged, it must be replaced with a special cable of the same type (available from Miele) by a Miele-authorized service technician only.
- ▶ This dishwasher is supplied with a special bulb to cope with particular conditions (e. g. temperature, moisture, chemical resistance, abrasion resistance and vibration). This special bulb must only be used for the intended purpose. It is not suitable for room lighting. Replacement bulbs may only be fitted by a Miele-authorized technician or the Miele Technical Service.

IMPORTANT SAFETY INSTRUCTIONS

Proper installation

▶ The dishwasher must be installed and connected in compliance with the installation plan.



▶ Be careful when installing the dishwasher. Wear protective gloves to avoid injury on any sharp metal components.

▶ The dishwasher must be correctly aligned horizontally to ensure problem-free operation.

▶ In order to ensure stability, built-under and integrated dishwashers must only be installed under a continuous counter which is secured to adjacent cabinetry.

▶ The door springs must be adjusted equally on both sides. They are correctly adjusted when the door remains stationary when left half open (approx. 45° opening angle). It is also important that the door cannot fall open.

The appliance may only be used with correctly adjusted door springs.

IMPORTANT SAFETY INSTRUCTIONS

Proper use

- ▶ Do not use solvents in the dishwasher. Danger of explosion!
- ▶ Do not inhale or ingest powder detergent. Dishwasher detergents contain irritant or corrosive ingredients which can cause burning in the nose, mouth, and throat if swallowed, or inhibit breathing. Seek medical attention immediately if detergent has been swallowed or inhaled.
- ▶ Avoid leaving the door open unnecessarily as someone could trip over it and be injured by it.
- ▶ Do not sit or lean on the opened door. This could cause the dishwasher to tip and be damaged, and you could get injured.
- ▶ Dishes can be very hot at the end of a program. Allow them to cool until they are comfortable enough to handle before unloading.
- ▶ Only use detergent and rinse aid formulated for domestic dishwashers. Do not use dishwashing liquid.
- ▶ Do not use commercial or industrial detergents as these may cause damage, and there is a risk of a severe explosive chemical reaction (such as an explosive oxyhydrogen gas reaction).
- ▶ Do not fill the rinse aid reservoir with powder or liquid detergent. This will cause serious damage to the reservoir.
- ▶ Inadvertently filling the salt reservoir with powder or liquid dishwasher detergent will damage the water softener. Make sure you have picked up the correct packet of dishwasher salt before filling the salt reservoir!
- ▶ Only use special coarse grained dishwasher salt for reactivation. Do not use other salts such as cooking salt, agricultural grade or gritting salt. These may contain insoluble additives which can impair the functioning of the water softener.

IMPORTANT SAFETY INSTRUCTIONS

- ▶ In an appliance with a cutlery basket (depending on model), cutlery is cleaned and dried more efficiently if placed in the basket with the handles downwards. However, to avoid the risk of injury, place knives and forks with the handles upwards.
- ▶ Plastic items which cannot withstand being washed in hot water, such as disposable plastic containers or plastic cutlery should not be cleaned in the dishwasher. The high temperatures in the dishwasher may cause them to melt or lose shape.
- ▶ If you use the "FlexiTimer/Delay Start" option (depending on model), make sure that the dispenser is dry before adding detergent. Wipe dry if necessary. Detergent will clog if poured into a damp dispenser and may not be thoroughly dispersed.
- ▶ Please observe the information given in "Technical data" regarding the capacity of the dishwasher.

Accessories

- ▶ Use only genuine original Miele parts. If spare parts or accessories from other manufacturers are used, the warranty may become invalid.

Disposal of your old dishwasher

- ▶ Make the door lock inoperative so that children cannot accidentally shut themselves in. Remove or destroy the locking bracket of the door lock, and make appropriate arrangements for the disposal of the appliance.

IMPORTANT SAFETY INSTRUCTIONS

SAVE THESE INSTRUCTIONS AND PASS THEM ON TO ANY FUTURE USER

FCC Declaration of Conformity

▶ These devices comply with FCC Rules Part 15. This equipment has been tested and found to be in compliance with the limits for a Class B digital device, pursuant to Part 15 of the FCC Rules of Operation and is subject to the following conditions:
These devices may not cause harmful interference.
These devices must accept any interference received, including interference that may cause undesired operation.

FCC Radiation Exposure Statement

▶ This equipment complies with FCC radiation exposure limits set forth for an uncontrolled environment. This equipment should be installed and operated with minimum distance 8" (20 cm) between the radiator and your body.

Industry Canada Statement

▶ This digital apparatus does not exceed the Class B limits for Radio Noise Emissions from digital apparatus set out in the Radio Interference Regulations of the Canadian Department of Communications.

Complies with Canadian ICES-003 Class B specifications.

Appliance overview

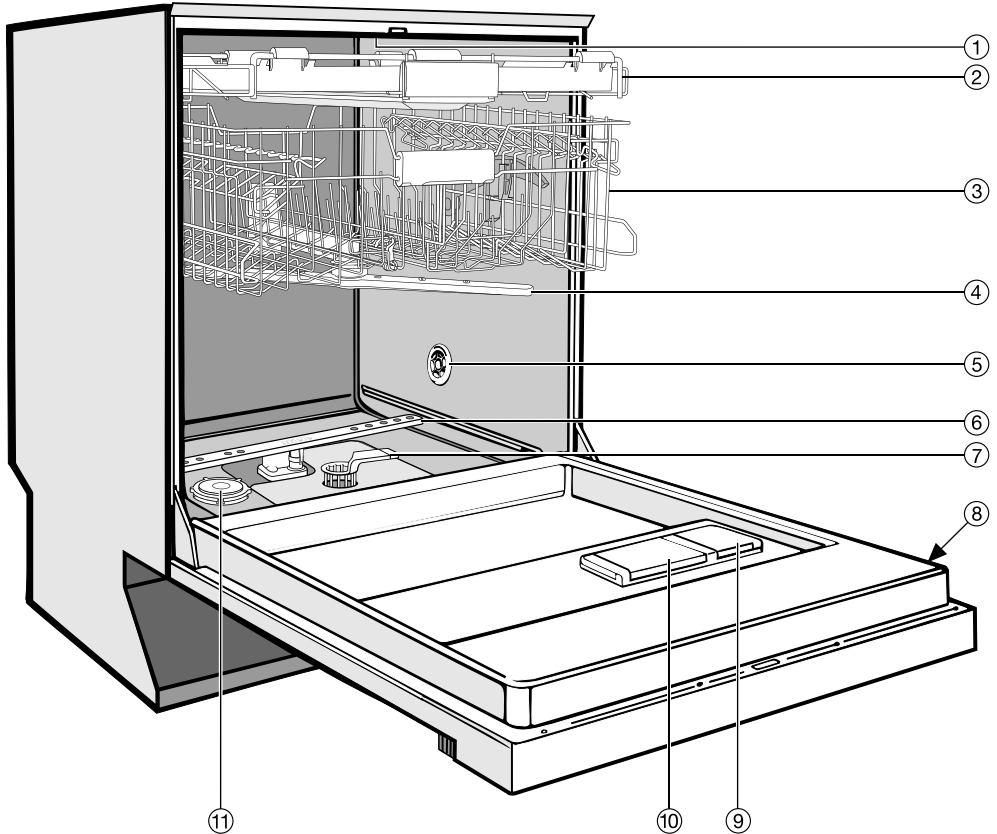



- | | |
|--|--------------------------------------|
| ① Upper spray arm (not visible) | ⑦ Filter combination |
| ② Cutlery tray (depending on model) | ⑧ Data plate |
| ③ Upper basket | ⑨ Rinse aid reservoir |
| ④ Middle spray arm | ⑩ Double-chamber detergent dispenser |
| ⑤ Heat exchanger return (depending on model) | ⑪ Reservoir for reactivation salt |
| ⑥ Lower spray arm | |

Guide to the dishwasher

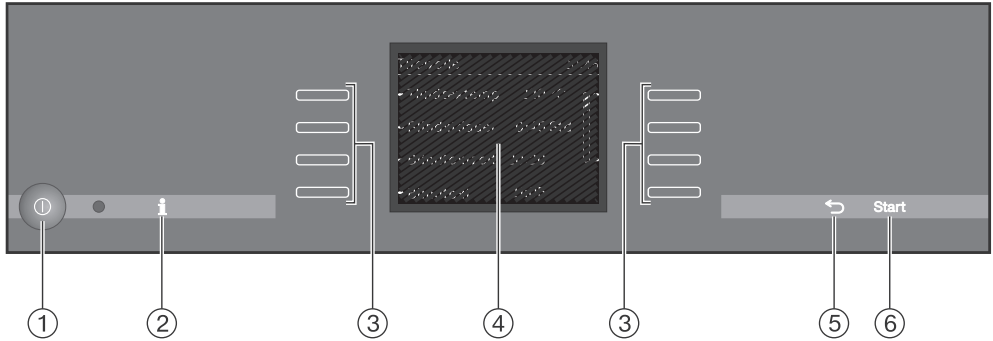
Control panel



- ① **On/Off**  **sensor**
For switching the dishwasher on and off.
- ② **Information**  **sensor**
For displaying further information about the menu selected.
- ③ **Selection sensors**
For selecting the menu option marked with a dash listed next to the sensor.
For selecting a program.
For altering values displayed.
For navigating to further screens.
The selection sensors light up when active.
- ④ **Display**
See "Function of the display" for more information.
- ⑤ **"Back"**  **sensor**
For navigating back to the previous menu or deleting values which have been set previously.
- ⑥ **Start sensor**
For starting the selected program.

These operating instructions apply to several different dishwasher models with different heights.

The specific dishwasher models are referred to as follows:
Standard = 31 11/16" (80.5 cm) high dishwashers (integrated)
and 33 1/4" (84.5 cm) high dishwashers (freestanding)
XXL = 33 1/4" (84.5 cm) high dishwashers (integrated)

Display functions

General information

The display is used to select or set the following:

- The program
- Any options
- The Delay Start function
- The Settings  menu
- The display of information

The display can show the following:

- The program name
- The program stage
- The current time of day and the date
- The estimated time left for the program to run
- Any relevant fault messages and information

To save energy, the dishwasher turns off after a few minutes if you do not press any buttons during this time. To switch the dishwasher back on again, press the  button.

A dash - in the display next to a sensor button indicates that a function can be selected with that sensor button. The relevant sensor button lights up.

The scroll bar  on the right of the display indicates that more options or more text are available which can be displayed by touching the relevant illuminated sensor button.

A dotted line will appear under the last option available.

Touch the sensor button next to OK to confirm a message or setting and also to move to the next menu or another menu level.

A check  will appear beside the option which is currently selected.

To exit a sub-menu, touch the  sensor button (Back).

If you do not press any of the sensor buttons for several seconds, the display will return to the previous menu level.

You may need to enter your settings again.

The Settings  menu is to adapt the electronic module of the dishwasher to changing requirements (see "Settings menu").

Caring for the environment

Disposal of the packing material

The cardboard box and packing materials protect the appliance during shipping. They have been designed to be biodegradable and recyclable.

Ensure that any plastic wrappings, bags, etc. are disposed of safely and kept out of the reach of children. Danger of suffocation!

Disposal of your old appliance

Electrical and electronic appliances contain valuable materials. They also contain certain substances, compounds and components which were essential for the proper functioning and safe use of the equipment. Handling these materials improperly by disposing of them in your household waste can be harmful to your health and the environment. Therefore, please do not dispose of your old appliance with regular household waste and follow local regulations on proper disposal.



Consult with local authorities, dealers or Miele in order to dispose of and recycle electrical and electronic appliances. Miele assumes no responsibility for deleting any personal data left on the appliance being disposed. Please ensure that your old appliance is kept away from children until removal. Observe safety requirements for appliances that may tip over or pose an entrapment hazard.

Energy-saving dishwashing

This dishwasher is economical in the consumption of water and energy.

For best results follow these tips:

- For most economical dishwashing, make full use of the baskets without overloading the dishwasher.
- Choose a program that best suits the degree of soiling and the type of dishes being washed.
- Select the Normal program (depending on model) for energy-saving dishwashing. This program is the most efficient in terms of its combined energy and water consumption at cleaning normally soiled dishes.
- If your dishwasher is connected to a hot water supply, select the Energy Saver program for washing a lightly to moderately soiled load. Because the water is not heated in this program, dishes may still be slightly damper at the end of this program than it would be with other programs.
- Follow the detergent manufacturer's recommendations on detergent dosage.
- When using powder or liquid detergent, you can use $\frac{1}{3}$ less detergent if baskets are only half full.

Before using for the first time

Opening the door

At the end of programs with a drying phase (see "Program overview"), the door will open automatically a little in order to help the drying process.

This function can be deactivated if preferred (see "Settings menu, AutoOpen").

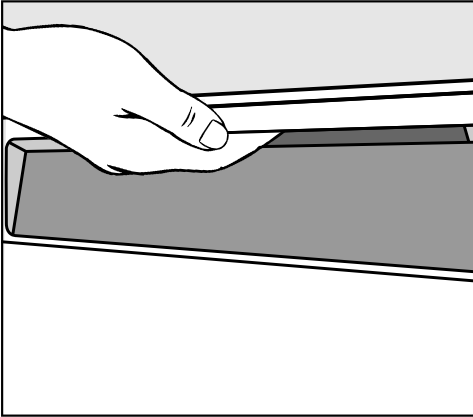

- To open the door, reach under the recessed handle and pull.
- Open the door fully to disengage the locking mechanism.

The door locking pins will retract.

If the door is opened during operation, all functions are automatically interrupted.

⚠ Water in the dishwasher may be hot. Danger of scalding!

Only open the door during operation if absolutely necessary and exercise extreme caution when doing so.

⚠ Keep the area around the door free of obstructions.

Before using for the first time

Closing the door

- Push the baskets in.
- Then raise the door upwards until the catch engages.

The door will then close automatically.

 **Danger of crushing injuries!**
Do not put your hand inside the door as it is closing.

Child lock

The child lock can be used to prevent children opening the dishwasher. The door can then only be opened by using a lot of force.

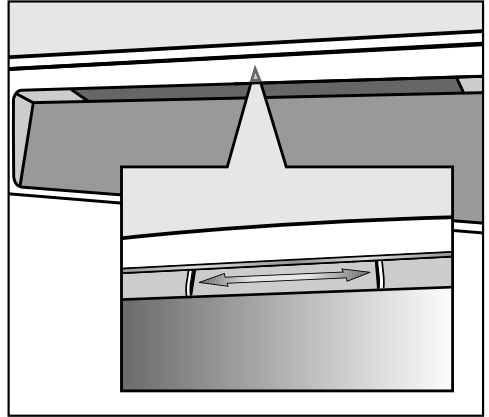

- To lock the door, push the slide underneath the recessed handle to the right.
- To unlock the door, push the slide to the left.

Before using for the first time

Basic settings

- Turn the dishwasher on using the ① sensor button.

The welcome screen will appear when the dishwasher is turned on for the first time.

Language

The display will change automatically to the screen for setting the language.

- Select the language you want as well as the country, if appropriate, and confirm with OK.

For more information about the function of the display, see "Display".

A check ✓ will appear next to the language that has been set.

Date

The display will change to the screen for setting the date.

You can show the actual date and time in the display.

- Set the year using +/- and confirm with OK.
- Then set the month and the day and confirm them with OK.

Keeping the relevant sensor pressed will increase or decrease the time automatically.

Time of day

The display will then change to the screen for setting the time.

The time of day needs to be set before the *Delay start* programming option can be used.

The time of day can also be shown in the display.

- Use +/- to set the hour and confirm with OK.
- Then set the minutes and confirm with OK.

Time of day display

The display will then change to the screen for setting the display for the time of day.

- Select the display you require for the time of day, and confirm this with OK.
- Confirm the message about energy consumption with OK.

Before using for the first time

Water hardness

The display changes to the screen for setting the water hardness.

- The dishwasher must be programmed to the correct water hardness for your area.
- Your local water authority will be able to advise you of the water hardness level in your area.
- Where the water hardness fluctuates e.g. between 10 - 16 gr/gal (10 - 15 °d), always program the dishwasher to the higher value (16 gr/gal or 15 °d in this example).

It is useful to know your water hardness so that you can provide the service technician with this information in the event of any service calls.

Enter the water hardness below:



_____ gr/gal (°d)

The dishwasher is programmed at the factory for a water hardness level of 1 gr/gal (1 °d).

- Select the water hardness level for your water supply and confirm with OK.

See "Settings menu, Water hardness" for more information.

The message Set up successfully completed will then appear in the display.

After confirming this message OK, the refill indicators  Refill salt and  Refill rinse aid may appear.

- Add salt and rinse aid if necessary (see "Before using for the first time, Dishwasher salt" and "Rinse aid").
- Confirm the messages with OK.

The display will switch to the main menu.

The prompt to set up the dishwasher for first use will not appear again after you have run the first complete program.

Before using for the first time

Before using the appliance for the first time, you require:

- Approx. 2 qt (2 l) of water
- Approx. 2 kg (4 lbs) of dishwasher salt
- Domestic dishwasher detergent
- Rinse aid formulated for domestic dishwashers

Every dishwasher is tested at the factory. There will be residual water in the appliance from this test. It is not an indication that it has been used previously.

Dishwasher salt

In order to achieve good cleaning results, the dishwasher needs to operate with soft water. Hard water results in a build-up of calcium deposits on dishes and in the dishwasher.

Water supplies with a hardness level higher than 4 gr/gal (4 °d) needs to be softened. This takes place automatically in the integrated softener assembly. The softener assembly in the dishwasher is suitable for a water hardness level of up to 73 gr/gal (70 °d).

The softener assembly requires dishwasher salt.

Depending on the water hardness level (< 22 gr/gal or 21 °d), dishwasher salt is not required if combination tablets are being used (see "Operation - Detergent").

If the water in your area is very soft and consistently **lower than 5 gr/gal (5 °d - German scale)** you do **not** have to add dishwasher salt. The prompt to add salt will be switched off automatically if the softener assembly has been programmed for this to happen.

 Dishwasher detergent will damage the softener assembly.

Do not fill the salt container with dishwasher detergent (even liquid detergent).

 Use only special, coarse-grained dishwasher salt or other pure kitchen salt.

Other types of salt may contain insoluble components which can damage the softener assembly.

Before using for the first time

Filling the salt reservoir

Important! Before filling the salt reservoir with dishwasher salt for the first time, you must fill it with approx. 2 qt (2 l) of water to enable the salt to dissolve.

Once the dishwasher has been used for the first time, there is always sufficient water in the reservoir.

- Remove the lower basket from the wash cabinet and unscrew the salt reservoir cap.

Water will run out of the reservoir when the cap is removed. It should therefore only be removed in order to refill the salt reservoir.

- Fill the reservoir with approx. 2 qt (2 l) of water (first use only).

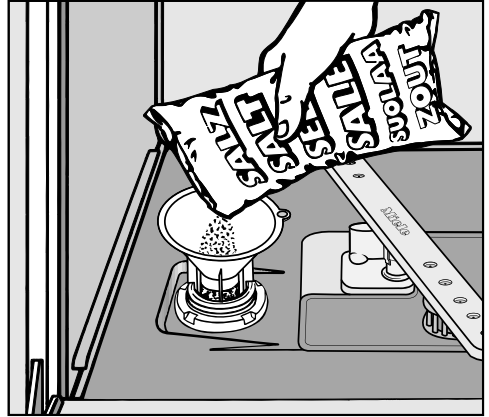

- Place the funnel provided over the salt reservoir and carefully fill with salt until the reservoir is full. The salt reservoir holds approx. 4 lbs (2 kg) of salt depending on the brand used.
- Clean any excess salt from around the reservoir opening and then screw the cap on again firmly.
- Immediately after filling the salt reservoir, run the *QuickIntenseWash* program with the *Short* programming option selected and without any dishes in the dishwasher to remove any traces of salt from the wash cabinet.

Before using for the first time

Salt refill indicator

- Fill the salt reservoir with dishwasher salt for reactivation when  Refill salt appears in the display. If it appears during a program, wait until the end of the program.
- Confirm with *OK*.

The message will go out.



Risk of corrosion!

Immediately after filling the salt reservoir, run the *QuickIntenseWash* program with the *Short* programming option selected and without any dishware in the dishwasher to remove any traces of salt from the wash cabinet.

After the salt reservoir has been filled, the refill indicator may still appear in the display if the salt concentration has not yet reached the correct level. If this is the case, confirm again with *OK*.

The salt refill indicator will be turned off if you have programmed the dishwasher for a water hardness below 5 gr/gal (5 °d).

If you only ever use Tab products in your dishwasher, you can switch off both refill indicators for salt and rinse aid if you wish (see "Settings menu, Switching off the refill indicators").

If you switch to using detergent that does not contain salt or rinse aid, it is important to remember to add dishwasher salt and rinse aid and to switch the indicators back on.

Before using for the first time

Rinse aid

Rinse aid is needed to prevent spotting on dishes and glassware. The rinse aid is filled in the reservoir and the set amount will be automatically dosed.

 Filling the rinse aid reservoir with detergent will damage the reservoir. Only pour rinse aid formulated for residential dishwashers into the reservoir.

When using "Tab" detergents rinse aid is not needed.

Adding rinse aid

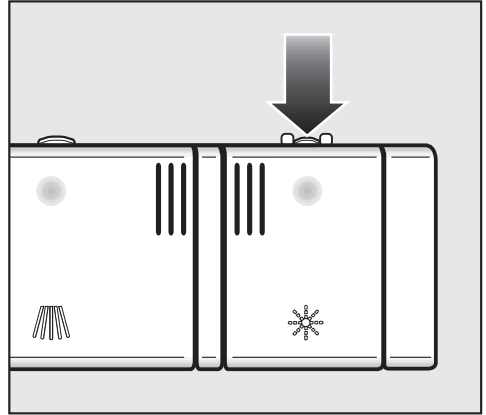

- Press the button on the lid of the rinse aid reservoir in the direction of the arrow until the flap springs open.

Before using for the first time

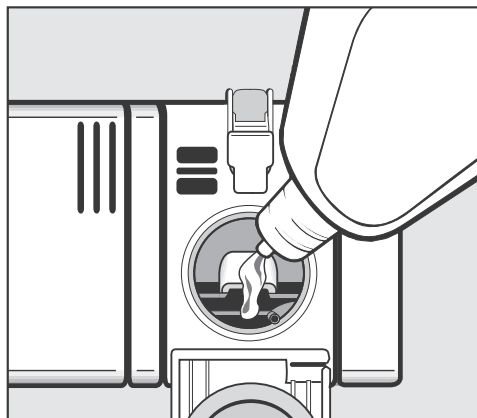

- Add rinse aid only until it is visible in the opening.

The rinse aid reservoir holds approx. 3.7 oz. (110 ml).

- Close the flap firmly so that it clicks into place. Otherwise water can enter the rinse aid reservoir during a program.
- Wipe up any spilled rinse aid. This prevents over-foaming occurring during the next program.

You can adjust the rinse aid dosage for best results (see "Settings menu - Rinse aid").

Rinse aid indicator

When the ☼ Refill rinse aid message appears in the display, the reservoir contains sufficient rinse aid for 2 - 3 programs only.

- Add rinse aid.
- Confirm with **OK**.

The message will go out.

If you only ever use Tab products in your dishwasher, you can turn off both refill indicators for salt and rinse aid if you wish (see "Settings menu - Turning off the refill indicators").

Loading the dishwasher

Tips

Remove coarse food residues from the dishes.

There is no need to rinse items under running water!

 Do not wash items soiled with ash, sand, wax, grease, or paint in the dishwasher. These will damage the dishwasher.

Dishes can be loaded anywhere in the baskets, but the following notes should be observed:

- Do not place dishes or cutlery inside other pieces. They will cover each other.
- Load the dishes so that water can access all surfaces. This ensures that they get properly cleaned.
- Make sure that all items are securely positioned.
- Hollow items such as cups, glasses, pans, etc. must be inverted in the basket.
- Tall, narrow, hollow items, e.g., champagne glasses, should be placed in the center of the basket to ensure better water coverage.
- Concave items such as mugs or bowls should be placed at an angle so that the water can run off.
- The spray arms must not be blocked by items which are too tall or hang through the baskets. If in doubt, test for free movement by manually rotating the spray arms.

- Make sure that small items cannot fall through the holders in the baskets.
Small items, e.g., lids, should therefore be placed in the cutlery tray or cutlery basket (depending on model).

Some foods may contain natural dyes, e.g., carrots, tomatoes or tomato sauce. Plastic items in the dishwasher may discolor if large quantities of these foodstuffs find their way into the dishwasher on the dishes. The stability of plastic items is not affected by this discoloration. Cleaning silver cutlery in the dishwasher may also cause plastic items to discolor.

Loading the dishwasher

Items not recommended for dish-washing

- Wooden cutlery, cutting boards and dishes or items with wooden parts
- Craft items, antiques, valuable vases, and decorative glassware
- Plastic items which are not heat-resistant: the high temperatures in the dishwasher may cause them to melt or lose shape.
- Copper, brass, tin and aluminum items may discolor or become matt.
- Colors painted over a glaze may fade after a number of washes.
- Delicate glassware and glassware containing lead crystal: clouding may occur over time.

Please note:

Silverware previously cleaned with a **silver polish** may still be damp or spotted at the end of a program, where water has not run off smoothly. It may need to be rubbed dry with a soft cloth.

Silver which has been in contact with foods containing sulphur can discolor. These include egg yolk, onions, mayonnaise, mustard, fish, and marinades.

 Aluminum components (e.g., range hood grease filters) must not be cleaned with a commercial or industrial cleaning agent. These may damage the material.

Tip: When purchasing new dishes and cutlery, make sure they are dishwasher-safe.

Glass care

- Clouding may occur on glasses after frequent washing. If delicate glassware is washed in the dishwasher, ensure that only very low temperatures are used (see program chart), or a special glass-care program is used (depending on model). This will reduce the risk of clouding.
- Purchase glassware which is dishwasher-safe (e.g., Riedel glassware).
- Use detergents with glass protective additives.

Loading the dishwasher

Loading examples

Loading for 10 standard place settings with cutlery tray

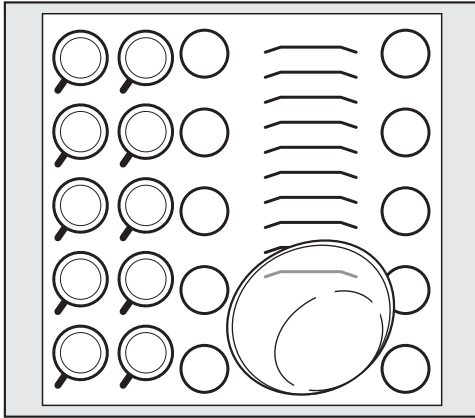

Upper basket

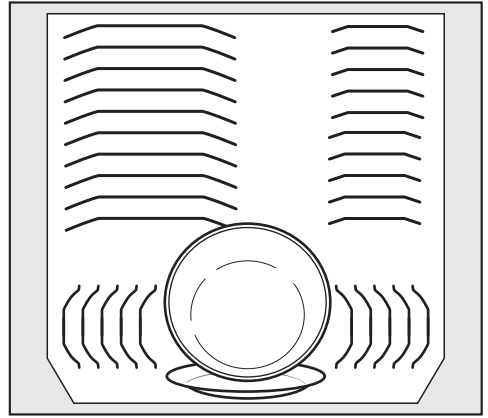

Lower basket

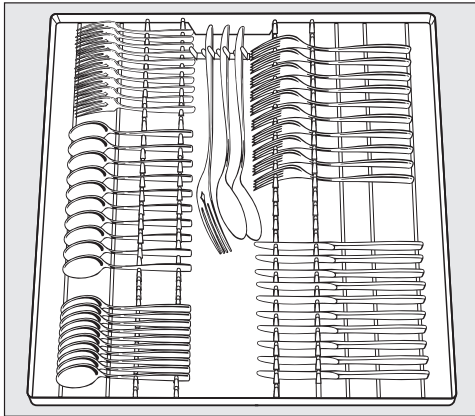

Cutlery tray (depending on model)

Loading the dishwasher

Loading for 16 standard place settings with cutlery tray

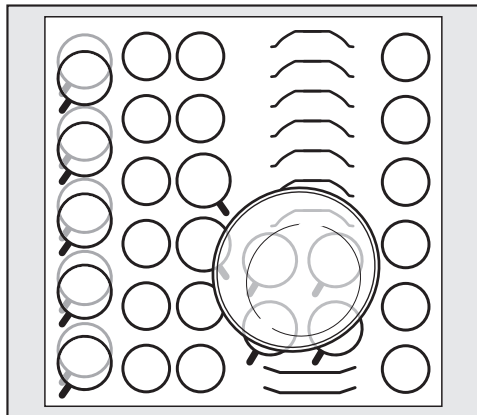

Upper basket

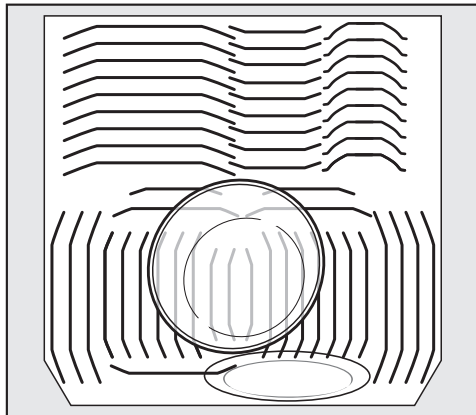

Lower basket

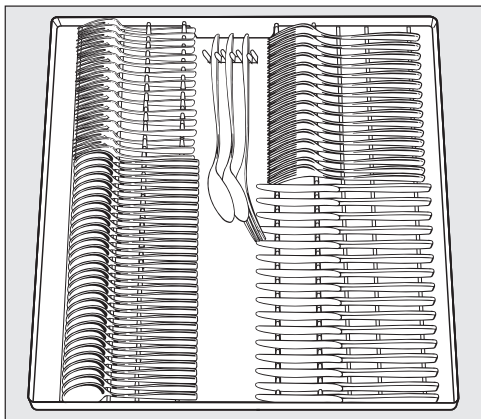

Cutlery tray (depending on model)

Loading the dishwasher

Loading for 10 standard place settings with cutlery basket

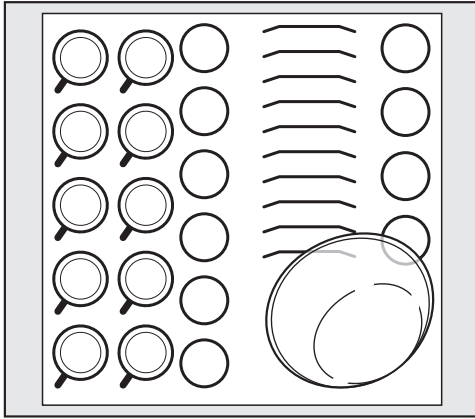

Upper basket

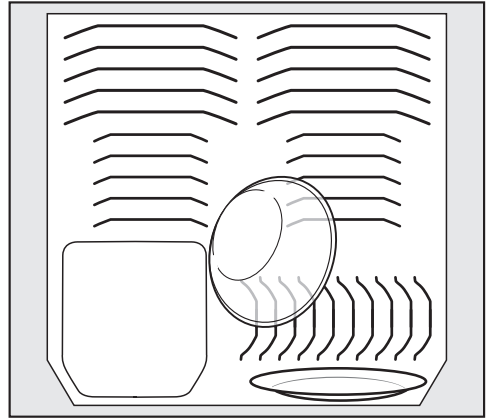

Lower basket

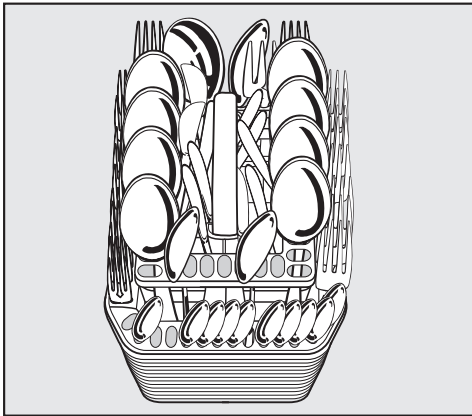

Cutlery basket

Loading the dishwasher

Loading for 13 standard place settings with cutlery basket

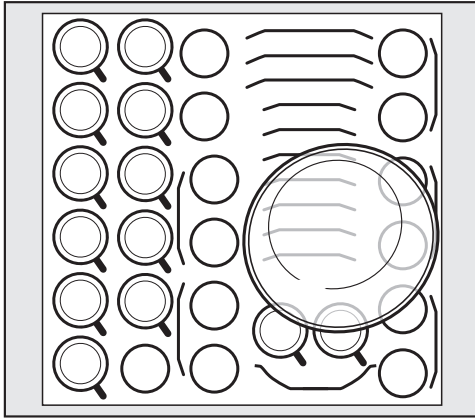

Upper basket

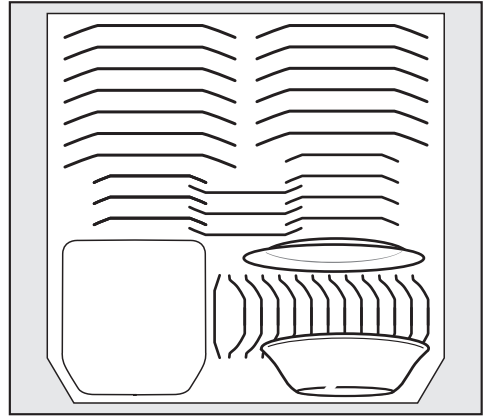

Lower basket

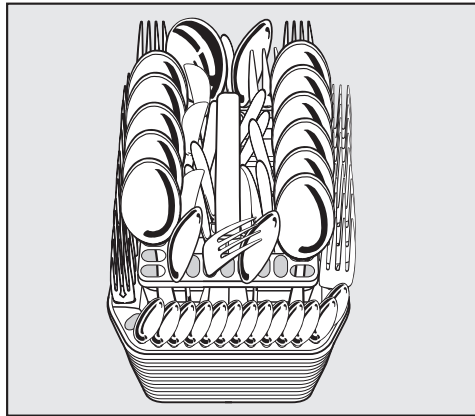

Cutlery basket

FlexAssist

The yellow FlexAssist components indicate which elements of the baskets for dishes and cutlery tray are moveable. They also act as grips and have symbols embossed on them to show what the moveable parts are used for.

Upper basket

 For safety reasons, do not operate the dishwasher without the upper and lower baskets in place (except when running the Tall items program, if available).

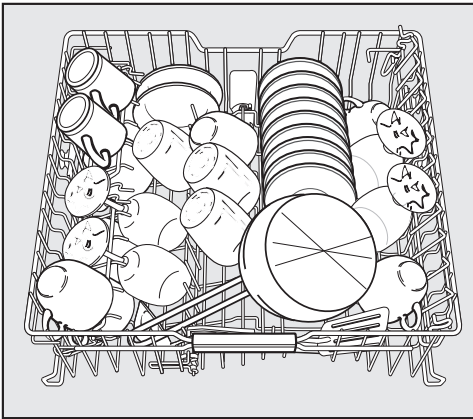

- Use the upper basket for small, light-weight and delicate items such as cups, saucers, glasses, dessert bowls, etc.
Shallow pans or casserole dishes can also be placed in the upper basket.
- Long items such as soup ladles, mixing spoons, and long knives should be placed lying down across the front of the upper basket.

Cup rack

- Using the yellow lever , lift the cup rack upwards to make room for tall items.

Glasses can be arranged along the positioning rail of the cup rack to give them some support during the program.

- Lower the cup rack and lean the glasses against it or double stack smaller pieces.

Loading the dishwasher

Hinged spikes

The rows of spikes can be lowered to make more room for larger items such as casserole dishes.

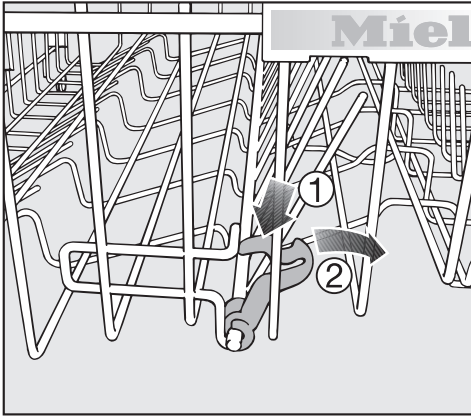

- Press the yellow lever downwards ① and then lower the spikes ②.

XXL cup rack (depending on model)

The cup rack can be set at two different widths so that it can also accommodate large cups.

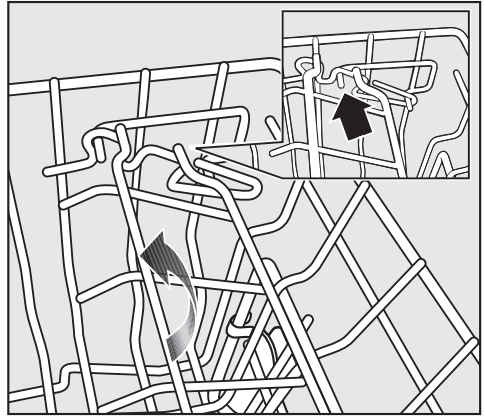



- Pull the cup rack upwards and click it back into position at the required width.

Loading the dishwasher

Glassware rail

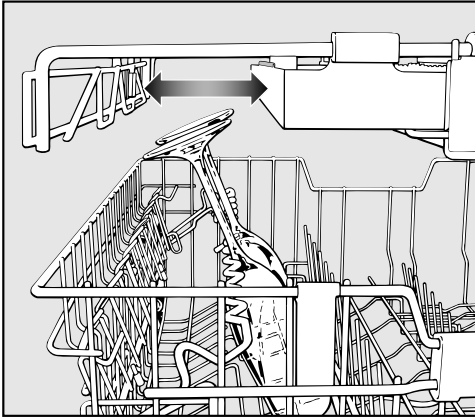
The glassware rail is designed to hold glasses with long stems securely.



- Lower the glassware rail with the yellow lever  and lean tall glasses against it.
- You can also move one of the side inserts in the cutlery tray to make more room for tall glasses (see "Cutlery, 3D cutlery tray").

Adjusting the height

You can set the glassware rail at two different heights.

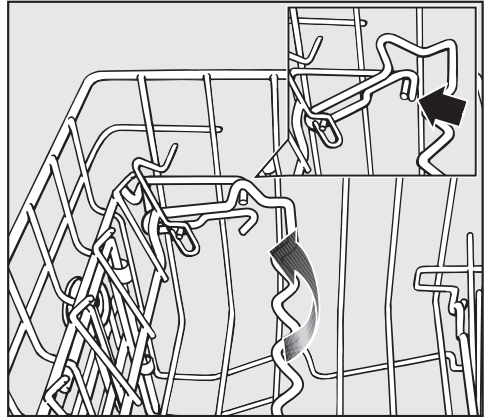

- Pull the rail upwards and click it back into position at the required height.

Use the lower position for small glasses and tumblers.

Use the higher position for tall glasses and glasses with stems.

Loading the dishwasher

Adjusting the upper basket

In order to gain more space for taller items the upper basket can be adjusted on three levels with 3/4" (2 cm) between each level.

The upper basket can also be set at an angle with one side high and the other side low. Make sure, however, that the basket can slide smoothly in and out of the cabinet.

- Pull the upper basket out.

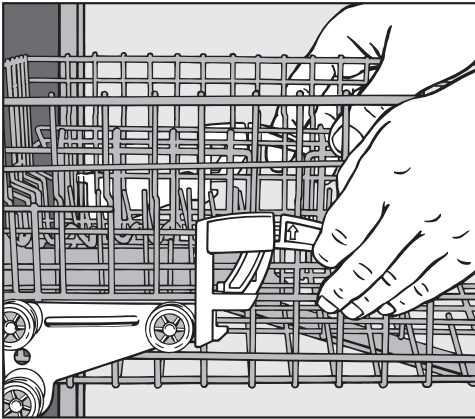

To raise the upper basket:

- Lift the basket until it clicks into place.

To lower the upper basket:

- Pull upwards on the levers at either side of the upper basket.
- Adjust the basket to the desired height and then push the levers securely back down into position.

Depending on the setting of the upper basket, the following plate dimensions can be accommodated.

Dishwashers with cutlery basket (see data plate for model number)

Upper basket adjustment	Plate Ø in inches (cm)		
	Upper basket		Lower basket
	ADA	Full-size	
Upper	7 7/8" (20)	9 7/16" (24)	12 3/16" (31) 13 3/4" (35*)
Middle	8 11/16" (22)	10 1/4" (26)	11 7/16" (29)
Lower	9 7/16" (24)	11" (28)	10 5/8" (27)

Dishwashers with cutlery tray (see data plate for model number)

Upper basket adjustment	Plate Ø in inches (cm)		
	Upper basket		Lower basket
	ADA	Full-size	
Upper	7 7/8" (15)	7 1/2" (19)	12 3/16" (31) 13 3/4" (35*)
Middle	6 11/16" (17)	8 1/4" (21)	11 7/16" (29)
Lower	7 1/2" (19)	9 1/16" (23)	10 5/8" (27)

* When tilted, plates of up to 13 3/4" (35 cm) can be accommodated (see "Lower basket").

Depending on the setting of the upper basket, a variety of plate dimensions can be accommodated.

Loading the dishwasher

Lower basket

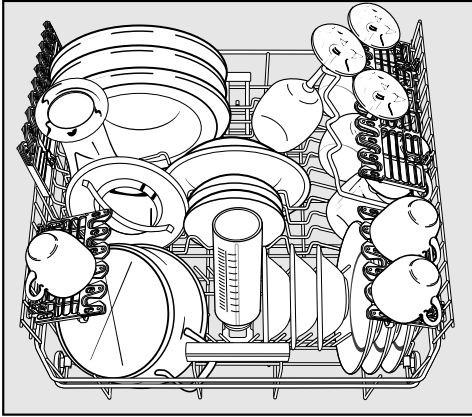

- For larger and heavier items such as plates, serving platters, saucepans, bowls, etc. Glasses, cups and small items such as saucers can also be placed in the lower basket. Do not place thin, delicate glassware in the lower basket.

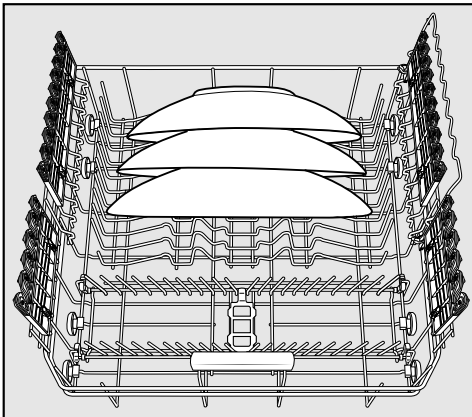

- Place large platters and dishes in the center of the lower basket.

When tilted, plates up to 13 3/4" (35 cm) in diameter can be accommodated.

Removable MultiComfort insert

The rear section of the lower basket is used for washing cups, glasses, plates, pots and pans.

You can remove the MultiComfort insert to make more room for larger items such as casserole dishes.

Removing the insert

- Pull the yellow handle forwards and remove the insert.

Refitting

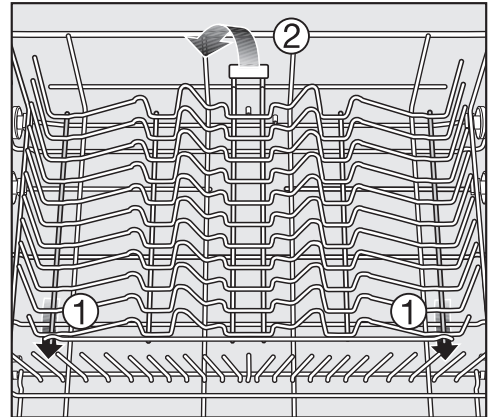

- Fit the insert into the lower basket with the hooks under the long cross-piece ①.
- Press down on the insert until it clicks into position ②.

Loading the dishwasher

FlexCare glass holder

Silicone padding in the FlexCare glass holder provides a stable and secure hold for delicate stemware.

- Stem glassware, e.g. wine glasses or champagne flutes, can be leaned against the glass rack or suspended from it.
- The glass holder can be raised to make more room for tall items.

You can set the glass holder at two different heights.

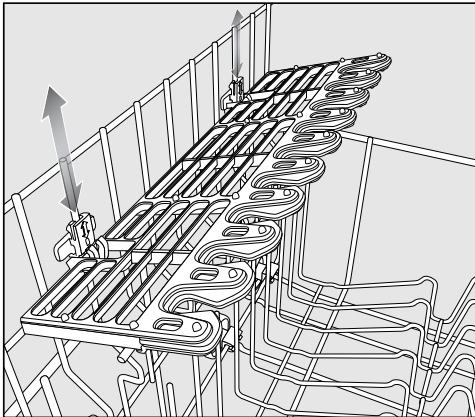

- Slide the glass holder to the desired height until the catches click into place at the top or bottom.

Glassware rail

The glassware rail is designed to hold glasses with long stems securely.

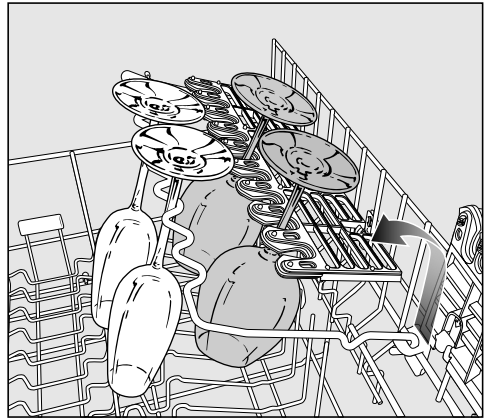

- Lower the rail and lean tall glasses against it.

Loading the dishwasher

Hinged spikes

The spikes at the front are used for washing plates, soup bowls, platters, dessert bowls, and saucers.

The spikes can be lowered to make more room for large items, e.g. pots, pans and dishes.

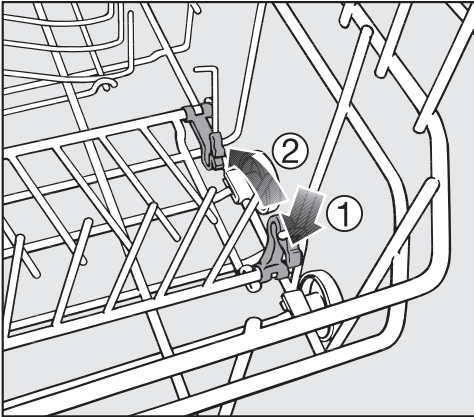

- Press the yellow lever downwards ①, and then lower the spikes ②.

Bottle holder

The bottle holder can be used to wash narrow items, e.g., milk and baby bottles.

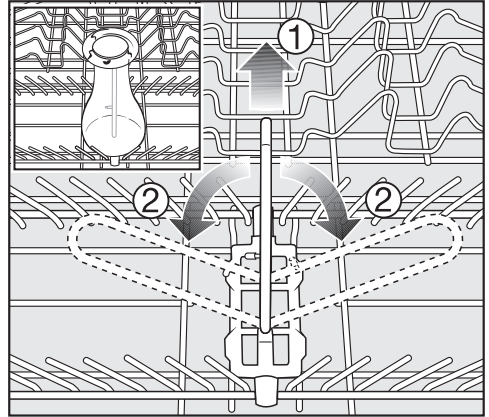

- If the bottle holder is not needed, lift it up ① and fold the sides down ②, as illustrated.

Loading the dishwasher

Pot rests and filters

You can also wash Miele pot rests and Miele hood filters.

- Select the **Grates & Filters** program for optimum dishwashing results.

⚠ Protruding parts can damage the dishwasher.

Load the dishwasher in such a way that no corners protrude over the side of the basket.

⚠ Heavy and sharp wash loads can damage the coating of the basket struts.

Load pot rests and filters carefully.

Pot rests

⚠ Rust damages the dishwasher. Wash only pot rests that are undamaged and not rusty.

- Place the upper basket in the top position.
- Load the pot rest in the lower basket. To do so, remove the MultiComfort insert and fold over the front row of spikes.
- Place the pot rest on the bottom of the basket and against the struts on one side. On the other side of the basket, flip up the glass holder and place this side of the pot rest on the silicone padding of the glass holder.

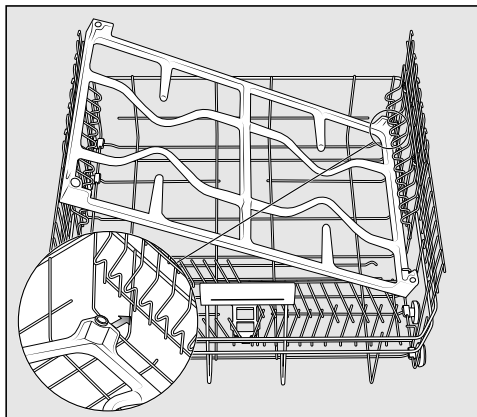

Loading the dishwasher

Filters

You can wash two range hood filters in the upper basket and two in the lower basket at once.

If you only want to wash two filters, put them in the top basket.

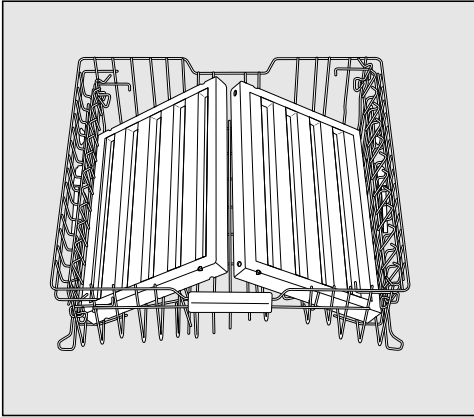

Upper basket

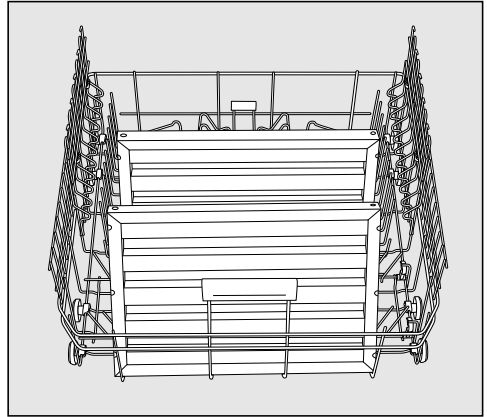

Lower basket

 Be careful when unloading the filters. At the end of the program, the filters may still contain hot water.

Loading the dishwasher

Cutlery

3D cutlery tray+ (depending on model)

- Arrange the cutlery in the tray as shown.

To make unloading much easier, cutlery should be grouped in zones, one for knives, one for forks, one for spoons, etc.

Spoon heads should be placed in contact with at least one of the serrated retainers on the base of the cutlery tray to ensure that water runs off them freely.

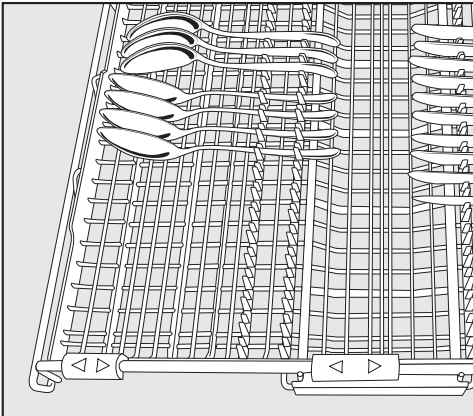

For optimum cleaning results arrange spoons with the inner part facing the center of the cutlery tray.

The upper spray arm must not be blocked by items which are too big.

The side sections of the tray can be moved into the middle using the yellow grips in order to accommodate tall cookware in the upper basket (see also "Upper basket - Glassware rack").

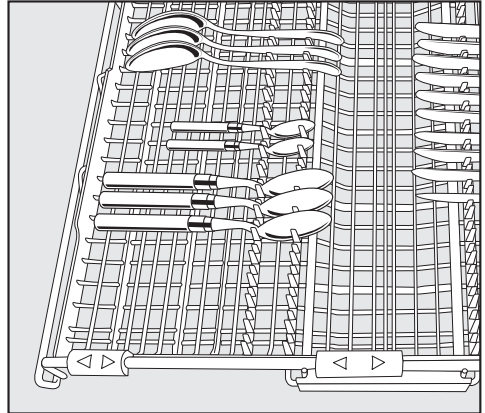

If spoon handles do not fit between the holders, lay them the other way round.

Loading the dishwasher

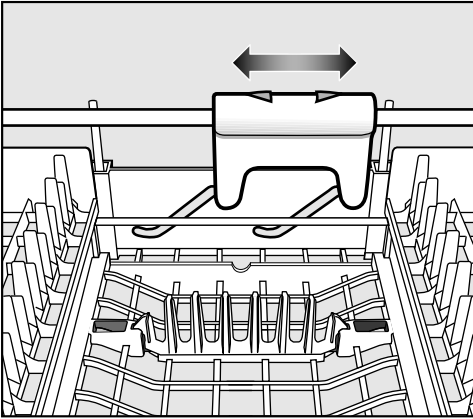

You can use the yellow slide to adjust the height of the middle section of the cutlery tray to make more room for large items of cutlery, such as serving spoons and ladles.

Both rows of spikes in the middle section of the cutlery tray can be flipped over to make room for larger pieces of cutlery.

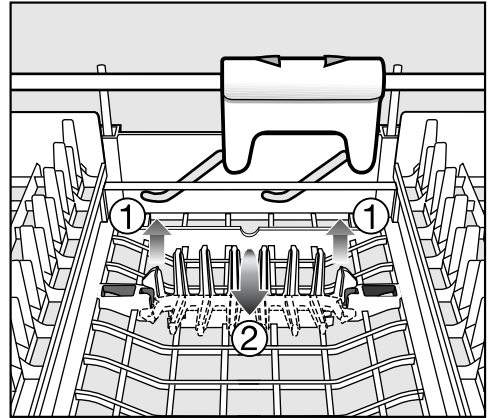

- Raise the spikes ① and then flip them over ②.

Operation

Detergent

 Only use detergents formulated for domestic dishwashers.

Active ingredients

Modern detergents contain various active ingredients, the most important of which are:

- Complexing agents to prevent calcification.
- Alkalis to aid the removal of dried-on soiling.
- Enzymes to break down starch and loosen protein.
- Oxygen-based bleaching agents to remove colored stains (e.g., tea, coffee, tomato sauce).

Most dishwasher detergents are mildly alkaline and contain enzymes and oxygen-based bleaching agents.

There are different types of detergent:

- Powder and liquid gel detergents. These detergents allow you to adjust the amount dispensed according to the amount of load and level of soiling.
- Tab detergents. These are suitable for most levels of soiling.

You can also buy Tab products (see "Options, DetergentAgent", if applicable).

In addition to detergent, these products contain rinse aid and salt substitutes. They are available as "3 in 1" or when they also contain other components such as glass and stainless steel protective additives and enhanced cleaning power, as "5 in 1", "7 in 1", "All in 1" etc.

Refer to the manufacturer's packaging as to whether Tab products are suitable for the water hardness level in your area.

Please note that the cleaning and drying results of Tab detergents can vary greatly.

For optimum cleaning and drying results, use Miele dishwasher detergent and add Miele salt and Miele rinse aid separately.

Detergent dosage

- Follow the dosage recommended by the manufacturer on the packaging.
- Unless directed otherwise, use one detergent tab or add 1 1/4 - 2 table-spoons (20 - 30 ml) detergent to compartment II, depending on the level of soiling. With very heavy soiling you can also add a small amount of detergent to compartment I.
- Tabs may not dissolve completely when the "QuickPowerWash" program (if available) is used.

Use only the recommended amount of detergent. Continued use of too much detergent may cause machine damage.

 Dishwasher detergents can cause burning in the nose, mouth, and throat if swallowed, or inhibit breathing.

Avoid inhaling or swallowing dishwasher detergent. Keep children away from detergent. Keep detergent out of the reach of children. Keep children away from the dishwasher when the door is open. There could still be detergent residues in the dishwasher. Only add detergent just before starting the program and lock the door with the child lock (depending on model).

Operation

Adding detergent

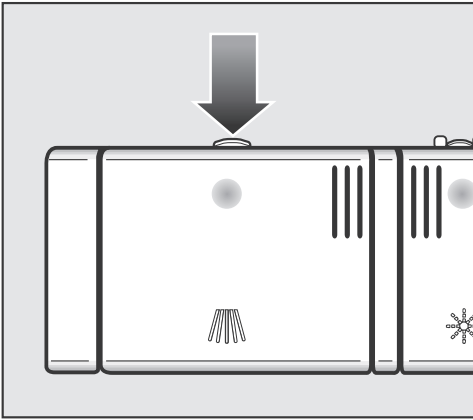

- Press the opening catch on the detergent dispenser. The flap will spring open.

The flap is always open at the end of a program.

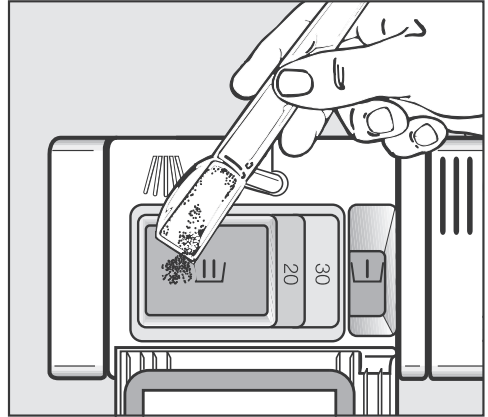

- Add the required amount of detergent and close the flap.
- Make sure that the detergent packaging is properly closed after use to avoid it getting damp and becoming lumpy.

Dispensing aid

Compartment I holds a maximum of 2 teaspoons (10 ml),

Compartment II holds a maximum of 3.5 tablespoons (50 ml) of detergent.

The marks in compartment II indicate the levels of approximately 1 ¼ and 2 tablespoons (20 and 30 ml) respectively. The marks indicate the approximate fill level in ml when the door is open in a horizontal position.

Turning on

- Make sure the spray arms are not obstructed.
- Close the door.
- Turn on the water supply if it is turned off.
- Turn the dishwasher on using the ⓘ sensor button.

The program menu of the last selected program will appear in the display.

Selecting a program

Choose your program according to the type of load and the degree of soiling.

The different programs and their uses are described in the **Program Overview** chapter.

- Use the selection sensor buttons to select the program you want.

The display will switch to the program menu.

Tap the ⓘ sensor button to call up more information about the program currently selected.

You can now select Options for your program (see "Options").

To select a different program, tap the ↩ sensor button to return to the main menu.

Operation

Starting a program

The dishwasher can be started only if the door is closed.

- Press the *Start* sensor button.

The program starts, and the prompt *Dishes can be added* appears in the display.

As long as this prompt is showing, dishes can be added without compromising the wash results.

 Water in the dishwasher may be hot. Danger of scalding from water in the cabinet.

Make sure you open the door very carefully.

A program should only be canceled in the first few minutes, if at all. Otherwise important program stages could be omitted.

Time display

The estimated duration of the program selected appears in hours and minutes in the display before the program begins. During the program, the time left until the end of the program is displayed.

Each program phase is indicated by a symbol:

-  Pre-wash / Soak
-  Wash
-  Interim rinse
-  Rinse cycle
-  Drying
-  Finish

The program duration displayed may vary with the same program. It is influenced by, among other things, the water temperature at each intake, the re-activation process, the softener assembly, the type of detergent, the amount of dishes, and the amount of soiling.

When a program is selected for the first time, the display will show the average program duration for a cold water intake.

The times shown in the program overview refer to standard test loads and temperatures.

Each time a program is run, the electronic module calculates the program duration required depending on the temperature of the water taken into the dishwasher and the amount of dishes.

Energy management

To save energy, the dishwasher will switch off automatically 10 minutes after the last time a button has been pressed or after the end of a program.

- Press the  sensor button to turn the dishwasher back on.

The dishwasher will not turn off automatically if the time of day display has been activated (see "Settings menu - Time of day").

The dishwasher will not turn off while a program is running, during the delay start period, or if there is a fault.

At the end of the program

The buzzer might sound at the end of the program.

The program has finished when Prog. finished appears in the display and the door has opened slightly (if applicable).

In the **QuickIntenseWash** program, the door will not open until a few minutes after the program has finished.

The drying fan may continue to run for a few minutes at the end of the program.

You can now empty the dishwasher.

 If you have deactivated the automatic door opening function (see "Settings menu, AutoOpen"), but would still like to open the door at the end of the program, make sure that you open the door fully. Otherwise steam from the dishwasher could damage the edge of the counter because the fan is no longer running.

Operation

Turning off the dishwasher

At the end of a program:

- The dishwasher can be turned off at any time using the ⓘ sensor.

Switching the dishwasher off during a program stops the program.

Turning the dishwasher off during the delay start time will also stop the process.

If the dishwasher is not going to be used for a longer period of time, e.g., while on vacation, the water supply should be turned off.

Unloading the dishwasher

Dishes tend to break and chip more easily when they are hot. Allow the dishes to cool until they are comfortable enough to handle before unloading them.

The dishes will cool much faster if you open the door when the program has ended.

First unload the lower basket, then the upper basket, and finally the cutlery tray (depending on model).

This will prevent water drops from the upper basket and cutlery tray from falling onto the dishes in the lower basket.

Interrupting a program

A program will be interrupted as soon as the door is opened.

- Close the door and press the *Start* sensor button.

The program will continue from the point at which it was interrupted.

 Water in the dishwasher may be hot. Danger of scalding!

Only open the door if absolutely necessary and exercise extreme caution when doing so. Before closing the door again, leave it ajar for approx. 20 seconds. This will enable the temperature in the wash cabinet to settle. After that, close the door and press the *Start* sensor button.

Changing a program

If the detergent dispenser flap has already opened, do not change the program.

If a program has already started and you wish to change it, proceed as follows:

- Press the  sensor button.
- Confirm the message *Cancel the program* with *Yes*.

The program will be canceled.

- Select the *Main menu* option.

The display will revert to the main menu.

- Select the program you want, and then start it.

Options

Options

In the program menu, you can select "Options" for the program you have selected before starting it.

- Turn the dishwasher on using the ① sensor button.
- Select a program.
- Select the Options menu option.

All available options will appear listed in the display.

Those that can be used with the program selected will be indicated by a dash and an illuminated sensor.

- Select the options you want.

A check will appear beside the extra to show that it has been set.

- To cancel the selection of an extra, touch the appropriate sensor again.
- When you have made all the settings, confirm with OK.

The display will change back to the program menu.

The number of options selected, e.g. 1 of 4, will appear in the program menu.

You can save the selected extras for the respective program (see "Settings menu, Save options").

Short

The Short option reduces the duration of the program in which this option is available by up to 30% (see "Program overview").

Selection of the Short option may take precedence over other selected options.

In order to achieve optimum cleaning results, energy consumption may increase slightly with this option.

When used in combination with the QuickIntenseWash program, the Short option results in a rinse cycle without drying or automatic opening of the door.

Extra economical

The Extra Economical extra reduces the energy consumption of programs in which this option is available by up to 20%.

In order to achieve optimum cleaning results, the program duration is extended with this option.

Intensive lower rack

The Intensive Lower Rack extra intensifies cleaning performance in the lower basket in programs in which this option is available.

Energy and water consumption are increased slightly due to the extended wash duration in the lower basket.

Extra dry

The Extra Dry extra improves the drying performance in programs in which this option is available.

Energy consumption is increased due to an extended fan running time and an increased final rinse temperature.

Soak

The Soak extra is used for soaking dishes with dried on soiling.

Energy and water consumption will increase with this extra.

If you are using powder dishwasher detergent, add approx. 5 g to compartment I.

Pre-Rinse

The Pre-Rinse extra can be used for removing easily soluble soiling from dishes.

Adding a pre-rinse will increase the program duration and increase energy and water consumption levels.

Options

Delay Start with EcoStart

There are three ways of delaying the start of a program. You can set the start time or the finish time of a program. You also have the option of taking advantage of time variable economy rates for electricity by using the EcoStart function.

When using the Delay Start function, make sure that the detergent compartment is dry before adding detergent. Wipe dry with a cloth if necessary. If the compartment is wet, powder detergent can become lumpy and stick to the dispenser, with the result that it is not fully dispensed. Do not use liquid detergent when selecting Delay Start, as it can run into the dishwasher before it is required.

 To prevent children coming into contact with dishwasher detergent: Do not fill the detergent dispenser **until just before starting the program**, i.e., before you activate the FlexiTimer with OK. Also activate the child lock.

- Turn the dishwasher on using the ① sensor.
- Select the program you want from the main menu.
- Select the Delay Start option from the program menu for the selected program.

You then have a choice of Start at, Finish at and EcoStart.

- Select the desired function.

Now enter the required time.

If, while you are setting the time, you do not press any sensors for several seconds, the display will revert to the previous menu. You will then have to enter your settings again.

If you keep the + or - sensor pressed, the value shown will automatically increase or decrease.

If the time of day display has been switched off (see "Settings menu, Time"), the display message will go out after 10 minutes following activation of a delay start time.

To switch the display message back on for a few minutes, press the ① sensor.

Start at

With the *Start at* function, you set the exact time at which you want the program to start.

- Use +/- to set the hour and confirm with OK.

The hour will be saved and the minute number pad will be highlighted.

- Use +/- to set the minutes and confirm with OK.

The display will switch to the program menu.

- Confirm with *Start* to start the program.

The *Start* indicator light will light up. The program name and the start time will then appear in the display.

When the set time is reached, the program selected will begin automatically.

Finish at

With the *Finish at* function, you set the time at which you wish the program to end.

- Use +/- to set the hour and confirm with OK.

The hour will be saved and the minute number pad will be highlighted.

- Use +/- to set the minutes and confirm with OK.

The display will switch to the program menu.

- Confirm with *Start* to start the program.

A message will appear in the display if the program cannot be completed by the set finish time because it has too long a running time.

The *Start* indicator light will light up. The program name and the estimated start time for the program selected will appear in the display.

The selected program will start automatically when the estimated start time is reached.

Options

EcoStart

The EcoStart function allows you to take advantage of time variable economy rates of electricity. Before you can use this option, you must set up to three electricity rate time zones (see "Settings menu, EcoStart").

You then set the latest time at which the program selected should end.

The dishwasher will start automatically in the lowest rate zone within the time set.

- Use +/- to set the hour and confirm with OK.

The hour will be saved and the minute number pad will be highlighted.

- Use +/- to set the minutes and confirm with OK.

The display will switch to the program menu.

- Confirm with *Start* to start the program.

The estimated start time for the program selected will appear in the display. The *Start* indicator light will light up to confirm that the program has started.

The selected program will start automatically during the most cost effective time zone. It will finish at the latest by the set finish time.

Changing or deleting set times

You can change the set times or the program before the start time in the display is reached.

- Select the *Change* menu option.

The display will switch to the program menu.

- Select the *Start at*, *Finish at* or *EcoStart* function.

- To change the set time, select the desired time with +/- and confirm with OK.

- To delete the set time, select the *Reset* option and confirm the reset time with OK.

The display will switch to the program menu.

If you open and close the door again before the start time is reached, the message *Press Start to continue* will appear in the display. Press the *Start* sensor to restart the delay start.

EcoTech Heat exchanger

This dishwasher is equipped with a heat exchanger in which fresh water for the rinse cycle is pre-heated in order to save energy. The heat exchanger is re-filled with fresh water towards the end of each phase that uses fresh water and is held there ready for the next part of the program.

If you do not wish to use this function it can be switched off (see "Settings - EcoTech Heat exchanger").

If water in the heat exchanger is not used for several weeks, it will be automatically drained and pumped away for hygiene reasons. This process takes a few minutes and will also be carried out if the dishwasher is switched off or the door is open.

The display will remain dark. The message *Empty system* will appear in the display when the ⓘ button is pressed. No other functions are available during this process.

Automatic drainage cannot be interrupted.

The heat exchanger can be manually drained for transporting the appliance, e.g. before moving house (see "Settings - EcoTech Heat exchanger").

The heat exchanger should only be used in conjunction with a cold-fill water supply.

This function should be switched off if your dishwasher is connected to a hot water supply.

Program overview

Program	When to use	Program sequence				
		Pre-wash	Main wash	Interim rinse	Final rinse	Drying
			°F/°C		°F/°C	
Normal ¹⁾	Program for regular use to completely wash a full load of normally soiled dishes with the ability to adjust energy and water consumption based on the soil load of the dishes.	As needed	117-140/ 47-60	X	140/ 60	X
Pots & Pans	For heavily soiled dishes and normally soiled pots, pans and utensils with dried on residue; use 20% more detergent than recommended.	2X	167/ 75	X	136/ 58	X
China & Crystal ☞	For temperature sensitive glassware and lightly soiled dishes, use 50% detergent recommended. GlassCare program for temperature-sensitive glasses and dishes with light soiling. Use 50% of the detergent amount.	X	113/ 45	X	136/ 58	X
Quick Intense-Wash	"Quick program" for standard dishes soiling that has not dried on.		149/ 65	X	140/ 60	X
Extra Quiet	Extra quiet program for mixed loads with standard, slightly dried-on food residue with a longer program duration.		115/ 46	X	131/ 55	X
Rinse & Hold	To rinse dishes when a complete program is not needed.	X				
SaniWash	To sanitize dishware, e.g. baby bottles, cutting boards and preparation dishes.		156/ 69	2X	158/ 70	X

¹⁾ This program is the most efficient in terms of its combined energy and water consumption for cleaning normally soiled crockery.

This program is used for energy labeling purposes.

Program overview

Consumption ²⁾			Duration ²⁾	
Energy		Water		
Cold water 50°F/10°C kWh	Hot water 120°F/49°C kWh	Gallons/Liters	Cold water 50°F/10°C h:min	Hot water 120°F/49°C h:min
0.92	1.11	3.2/12.1	2:38	2:00
1.25	1.55	3.8/14.5	3:38	3:07
0.80	1.05	3.4/13.0	2:33	2:03
1.15	1.25	3.0/11.5	1:15	0:58
0.80	1.00	2.5/9.5	4:35	4:28
0.01	0.20	1.1/4.0	0:14	0:14
1.40	1.65	3.3/12.5	3:02	2:31

²⁾ Values quoted are in accordance with 10 CFR 430 / C373-04. In practice there may be variations to these figures due to variable conditions and data recorded by the sensors. Durations shown will reflect your household conditions. Selecting program options will also affect consumption levels and program durations (see "Programme options").

The energy consumption with a hot water supply includes the energy used to heat the water (exception: EnergySaver, if available).

Program overview

Program	When to use	Program sequence				
		Pre-wash	Main wash	Interim rinse	Final rinse	Drying
			°F/°C		°F/°C	
Economy	Water and energy saving program for standard dishes soiling that has not dried on, with a long soaking time and a low temperature.		129/ 54	X	111/ 44	X
Clean Machine	Special cleaning program to remove grease deposits from the dishwasher.		167/ 75	2X	158/ 70	X
Grates & Filters	Wash program for cleaning Miele grates, the Miele griddle plate, and Miele ventilation hood filters.	2X	167/ 75	X	136/ 58	X
Tall items	For extra large, heat resistant items, e.g. large vases. Remove upper basket.	X	149/ 65	X	136/ 58	X
Glasses - No Rinse Aid	To wash glassware without detergent and rinse aid; rinse cycle with warm water.		104/ 40	2X	129/ 54	X
Energy Saver	The water intake temperature must be 115°F (45°C) for light to normally soiled dishes.	2X	X	X	X	X
Sensor Wash	Program for dried-on remains and non-sensitive loads. Temperature, water intake, program duration and electricity consumption are automatically adjusted to suit the level of soiling of the dishes.	As needed	113- 149/ 45-65	As needed	140- 160	X

Program overview

Consumption ²⁾			Duration ²⁾	
Energy		Water		
Cold water 50°F/10°C kWh	Hot water 120°F/49°C kWh	Gallons/Liters	Cold water 50°F/10°C h:min	Hot water 120°F/49°C h:min
0.65	0.85	2.5/9.5	3:58	3:25
2.00	2.30	5.7/21.5	3:07	2:35
1.40	1.70	3.8/14.5	4:00	3:25
1.05	1.20	3.6/13.5	2:22	1:49
0.75	0.95	3.2/12.0	1:26	1:06
	0.06	7.1/27.0		2:00
0.75 ³⁾ -1.15 ⁴⁾	0.85 ³⁾ -1.50 ⁴⁾	1.7/4.0 ³⁾ - 6.5/15.0 ⁴⁾	1:57-3:59	1:46-3:33

²⁾ Values quoted are in accordance with 10 CFR 430 / C373-04. In practice there may be variations to these figures due to variable conditions and data recorded by the sensors. Durations shown will reflect your household conditions. Selecting program options will also affect consumption levels and program durations (see "Programme options").

The energy consumption with a hot water supply includes the energy used to heat the water (exception: EnergySaver, if available).

³⁾ Part load with light soiling

⁴⁾ Full load with heavy soiling

Settings menu

Adjusting default values

Opening the Settings menu

- Turn the dishwasher on with the  sensor button if it is turned off.

The main menu will appear in the display.

If the memory function is activated, the program menu for the program last selected will be displayed instead (see "Settings menu - Memory"). If this is the case, use the  sensor button to get to the main menu.

To learn about the display, read the section with the same name.

- Select the **Settings**  option.

The display will switch to the **Settings**  menu.

- Select the option you want to change.

Press the  sensor button to see more information about the program currently selected.

Sub-menu options which have already been selected will have a check  beside them.

- To exit a sub-menu again, use the  sensor button.

The display will revert to the menu above.

Language

The display can be set to appear in one of several different languages.

You can change the language in the display via the **Language**  sub-menu.

- Select the language you want and confirm this with **OK**.

Some languages also have a country option to select.

- If so, select the appropriate country and confirm your selection with **OK**.

The flag after the word **Language**  acts as a guide if a language which you do not understand has already been set.

If this is the case, keep selecting the option which has a flag after it until you reach the **Language**  sub-menu.

Time of day

The dishwasher is delivered with the time of day (clock) display deactivated.

To save energy, the dishwasher will turn off automatically a few minutes after the last time a button has been pressed or after the end of a program.

Setting the time of day (clock) display

When the time of day (clock) display has been activated, the current time of day will appear in the display a few minutes after the last time a button has been pressed or after the end of a program. This increases energy consumption.

- Select the **Display** option.
- Select the setting you want and confirm with **OK**.
If the **Night dimming** option is selected, the time of day is automatically switched off at night.
- If you have selected **On** or **Night dimming**, confirm the message about higher energy consumption with **OK**.

Setting the clock format

You can select either a 24-hour or 12-hour clock.

- Select the **Clock format** option.
- Select the setting you want and confirm with **OK**.

Setting the clock

You can set the current time of day. The current time of day must be set before you can use the **Delay start** program option.

- Select the **Set the time** option.
- Set the hour with **+/-** and confirm with **OK**.
Then set and confirm the minutes.

The time of day has now been saved.

Date

You can set the actual date and show it in the display.

- Set the year with the **+/-** sensor buttons and confirm with **OK**.
Then set the month and the day and confirm them both with **OK**.

Settings menu

Water hardness

This appliance is fitted with a softener assembly.

The dishwasher must be programmed for the water hardness in your area.

- The dishwasher must be programmed to the correct water hardness for your area.
 - Your local water authority will be able to advise you of the water hardness level in your area.
 - Where the water hardness fluctuates e.g. between 10 - 16 gr/gal (10 - 15 °d), always program the dishwasher to the higher value (16 gr/gal or 15 °d in this example).
- Select the water hardness level for your area and confirm your selection with OK.

A check ✓ will appear beside the water hardness which has been set.

°d	gr/gal	°f	Display
1	1	2	1
2	2	4	2
3	3	5	3
4	4	7	4
5	5	9	5
6	6	11	6
7	7	13	7
8	8	14	8
9	9	16	9
10	10	18	10

°d	gr/gal	°f	Display
11	11	20	11
12	13	22	12
13	14	23	13
14	15	25	14
15	16	27	15
16	17	29	16
17	18	31	17
18	19	32	18
19	20	34	19
20	21	36	20
21	22	38	21
22	23	40	22
23	24	41	23
24	25	43	24
25	26	45	25
26	27	47	26
27	28	49	27
28	29	50	28
29	30	52	29
30	31	54	30
31	32	56	31
32	33	58	32
33	34	59	33
34	35	61	34
35	36	63	35
36	38	65	36
37-45	39-47	66-80	37-45
46-60	48-63	82-107	46-60
61-70	64-73	109-125	61-70

Rinse aid

You can adjust the rinse aid dosage for best results.

The rinse aid dosage is set in stages from 0 to 6.

It is set to 3 at the factory.

The rinse aid dosage can turn out to be higher than the set value due to the automatic adjustment of the *Automatic* program.

If spots appear on dishes and glassware:

- Increase the rinse aid dosage.

If clouding or smearing appears on dishes and glassware:

- Decrease the rinse aid dosage.
- Select the desired setting with +/- and confirm with OK.

EcoStart

In order to run your dishwasher in the most economical way, you can use the *EcoStart* option to take advantage of your electricity supplier's time variable rates (see "Options - Delay start with *EcoStart* - *EcoStart*").

With this option selected, your dishwasher will start automatically at your electricity supplier's cheapest rate times.

To use this function, you must first set up to three electricity rate time zones in which the dishwasher can start. You can allocate different priorities to these time zones. The time with the cheapest electricity rate will be given Priority 1.

Contact your electric supplier to find out the times of the cheapest electricity rates.

Once the electricity rate times have been set, you can use the *EcoStart* option to set the latest finish time required for each program.

The dishwasher will then start automatically in the cheapest electricity rate time and the program will end at the latest at the finish time set.

Settings menu

Setting the electricity rate times

Before you can use the EcoStart option, you must set at least one electricity rate time.

- Select an electricity rate time from R1-R3 to set.

The start of the electricity rate time selected will appear in the display and the hour number block will be highlighted.

- Use +/- to set the hours and minutes for the start time and confirm both with OK.

The end of the electricity rate time selected will appear in the display and the hours number block will be highlighted.

- Use +/- to set the hours and minutes for the end time and confirm both with OK.

The electricity rate time will be saved and its priority will appear in the display.

- Select the priority you want and confirm this with OK.
- Confirm the message with OK.

The electricity rate time will be activated.

Changing the electricity rate times

You can change the start, finish or priority of an electricity rate time.

- Select an electricity rate time from R1-R3 to change.
- Select the setting you want to change.
- Use +/- to change the setting and confirm with OK.

The change will be saved.

Deleting the electricity rate times

- You can delete the settings for an electricity rate time and in doing so deactivate the EcoStart option for this time zone.
- Select an electricity rate time from R1-R3 to delete.
- Select Delete.
- Confirm the query Delete rate R1? with Delete.

The settings for the electricity rate time selected will be reset.

- Confirm the message with OK.

The electricity rate time has now been deleted.

Networking

Your dishwasher is equipped with an integrated WLAN module.

In order to connect your dishwasher to your WLAN network, you must first activate the network function.

This will add the *Miele@home* menu option to the "Settings" menu.

Networking is deactivated at the factory.

Make sure that your WLAN network signal strength is strong enough at the installation site of your dishwasher.

- Select the setting you want and confirm with *OK*.

Miele@home

This menu option is only displayed if you have activated the network settings (see "Settings - Network").

There are a number of ways of connecting your dishwasher to your WLAN network:

Miele@mobile app

The Miele@mobile app can be used to connect to your network.

- Download the Miele@mobile app from one of the App stores.
- Follow the instructions in the app.

Settings menu

WPS Push button

As an alternative to networking your dishwasher via the Miele@mobile app, we recommend using WPS (Wireless Protected Setup). To do so, you will need a WPS-compatible router.

- Select the WPS push button menu option.

Please wait... will appear in the display.

- Activate the "WPS" function on your router within two minutes.
- Once connection has been established, confirm the message with OK.

The dishwasher will then revert to the Miele@home menu.

If the connection fails, you have probably not connected WPS to your router quickly enough. Repeat the steps above.

Remote control

Once you have installed the Miele@mobile app on your tablet PC or your smartphone, you will be able to operate your dishwasher remotely. Your dishwasher must be signed on to a WLAN network.

The Remote control function is activated at the factory.

If you do not wish to use remote control you can deactivate the function.

- Select the setting you want and confirm with OK.
- Touch the ↩ sensor twice to return to the main menu.

Once the Remote control function is activated, the MobileControl menu option will appear in the main menu.

In order to operate your dishwasher with the Miele@mobile app, the MobileControl function has to be activated.

- Select the MobileControl menu option.
- Close the door and press the *Start* sensor.

The *Start* indicator will light up and Remote control Active will appear in the display.

The dishwasher can now be operated remotely using the Miele@mobile app.

If the time of day display has been switched off (see "Settings menu, Time"), the display message will go out after 10 minutes following activation of a delay start time.

To switch the display message back on for a few minutes, press the ① sensor.

If you open the door and then close it again before you have started a program with the remote control, the message *Press Start to continue* appears in the display. Press the *Start* button to reactivate the *MobileControl* function.

If you now do not wish to operate the dishwasher remotely with the *Miele@mobile* app, you can cancel the *MobileControl* function.

- Select *Cancel* and confirm with *Yes*.

Module settings

We recommend connecting your dishwasher to your WLAN network using the *Miele@mobile* app or via WPS.

If you would rather set up the connection to your router yourself, or you have a special network configuration, you can enter the relevant settings with the necessary technical knowledge.

Start module activity

If you wish to reset all entered settings and values for *Miele@home*, you can restore the factory default settings on your WLAN module. Any settings which do not affect *Miele@home* will remain unchanged.

- Select *Restart w. default settings* and confirm with *OK*.

Please wait... will appear in the display.

The message *Restart successful* will appear in the display after a few minutes.

- Confirm the message with *OK*.

The WLAN module factory default settings have been restored.

If the factory default settings were not restored to your WLAN module, repeat the instructions above.

Settings menu

Changing the main menu

You can change the order of the programs in the program selection menu and also enter your favorite programs into the first four program places.

- Select the programs you want to place in the first to fourth position of the program selection menu.
- Confirm each position with **OK**.

The programs you have selected will then appear together in the display.

- If you are happy with the order in which they are shown, confirm with **OK**.
- To change the order in which they are shown, select **Change**.

Enter the settings again.

Saving options

Additional program options can be added to some programs, e.g., **Short** (see "Program options - Options").

You can use the **Save options** option to save settings you have chosen for a particular program so that they are automatically selected when you run the program in the future.

The dishwasher is delivered with this function deactivated.

- Select the setting you want and confirm with **OK**.

System lock

The system lock prevents your dishwasher being used without your knowledge.

If an attempt is made to switch the dishwasher on when the system lock is activated, System lock  will appear in the display.

The lock must be deactivated before the dishwasher can be used.

The appliance will lock each time it is switched on while the system lock is activated.

The appliance is delivered with the system lock deactivated.

- Select the setting you want and confirm with OK.

Deactivating the system lock

To unlock the dishwasher, proceed as follows:

- Switch the dishwasher on using the  sensor.

System lock  will appear in the display.

- Confirm with OK, keeping the sensor pressed for six seconds.

After six seconds, the dishwasher is unlocked and ready for use.

Temperature

You can set whether the temperature should be displayed in °C/Celsius or °F/Fahrenheit.

The factory default setting is °C.

- Select the option you want and confirm with OK.

Brightness

There are seven different display brightness settings.

- Select the brightness you want and confirm this with OK.

Settings menu

Volume

A sequence of buzzer tones will sound at the end of the program or if there is a fault as long as the buzzer has been activated.

Buzzer in the event of a fault

The buzzer in the event of a fault will sound four times at intervals with a short pause between each set of tones.

The buzzer which sounds when there is a fault cannot be deactivated.

Buzzer at the end of a program

The buzzer at the end of a program will sound four times at intervals with a short pause between each set of tones.

Buzzer tones

The volume of the tone at the end of the program can be selected in seven stages or switched off.

- Select the volume you want using the Quieter and Louder options, or turn the buzzer off.
- Confirm with OK.

Night time buzzer tone

You can select a different volume for the buzzer at night, or turn it off.

- Select the volume you want for the night time buzzer using the Quieter and Louder options, or switch the night-time buzzer off.
- Confirm with OK.

Night time

You can select the times for night time to begin and end.

- Select the Start at option.
- Use +/- to set the time in hours and minutes for the night time to begin and confirm both with OK.
- Select the Finish at option.
- Use +/- to set the time in hours and minutes for the night time to end and confirm both with OK.

Keypad tone

An audible tone sounds each time a sensor button is pressed.

The volume for the keypad tone can be set in seven stages or switched off.

- Select the volume you want using the Quieter and Louder options, or switch the keypad tone off.
- Confirm with OK.

Memory

With the Memory function activated, the dishwasher will save the last program selected.

When you switch the dishwasher off and back on again, the program menu for last program selected will appear in the display instead of the main menu.

- Select the setting you want and confirm with **OK**.

Refill indicators

If you consistently use a Tab detergent and the refill indicators for salt and rinse aid are bothering you, you can deactivate them if you wish.

- Select the setting you want and confirm with **OK**.

If you switch to using detergent that does not contain salt or rinse aid, it is important to remember to add dishwasher salt and rinse aid and to switch the indicators back on.

Check filters

You can adjust the interval at which the message to remind you to check the filters appears.

You can set an interval between 30 and 60 program cycles.

The "Check filters" message is set at the factory to appear after every 50 program cycles.

- Select the interval you want and confirm this with **OK**.

SensorWash

You can adjust the **Sensor Wash** program so that it will remove stubborn soiling from a lightly soiled load. Energy consumption will increase with this option.

- Select the setting you want and confirm with **OK**.

Settings menu

AutoOpen

At the end of programs with a drying phase, the door will open automatically a little in order to help the drying process (see "Program overview").

In the **QuickIntenseWash** program, the door will open a few minutes after the program has finished.

This function can be deactivated if wished.

- Select the setting you want and confirm with **OK**.

 If you have deactivated the automatic door opening function and would like to open the door as soon as the program has finished, make sure that you open the door fully. Otherwise steam from the dishwasher could damage the edge of the counter because the fan is no longer running.

BrilliantLight

This dishwasher has interior lighting. When the door is open, the lighting will switch off automatically after 15 minutes.

The interior lighting can be switched off.

- Select the setting you want and confirm with **OK**.

EcoTech Heat exchanger

This dishwasher is equipped with a heat exchanger (see "Programming options, Heat exchanger").

Status

The heat exchanger function can be switched off if you do not wish to use it.

- Select the **State** menu option.
- Select the setting you want and confirm with **OK**.

Manual draining

You can manually empty the heat exchanger, e. g. if it will not be used for a longer period of time, or before moving the appliance to a new location.

- Select the **Empty manually** menu option.

The process will start immediately.

Software version

You can display the electronic software version of your dishwasher electronics for technical support purposes.

- Confirm the display with *OK*.

Showroom program

For demonstration purposes only.

The dishwasher is fitted with various demonstration programs for showroom use.

- Demo mode
Demonstration program for showrooms.
- Demo with sound
This program activates the circulation pump to demonstrate the sound of the dishwasher.
- Demo Drying Plus
The door will open automatically.
- BrilliantLight
The interior lighting is on constantly.

Factory default settings



You can reset all dishwasher settings to the factory default settings.

You will be given the choice of *Appliance settings* or *Main menu*.

WLAN module settings (where applicable) have to be reset separately (see "Settings -Miele@home - Module settings").

- Select the desired menu item.
- Confirm the message *Reset settings?* or *Reset main menu?* with *Yes*.

Closing the Settings menu

To close the *Settings*  menu, use the  sensor. This will take you back to the main menu.

Cleaning and care

Check and clean your dishwasher regularly. This will help avoid problems and faults.

 All surfaces are susceptible to scratching. Contact with unsuitable cleaning agents can alter or discolor all surfaces.

Cleaning the wash cabinet

Generally, the wash cabinet is self cleaning if the correct amount of detergent is used.

If, however, there are limescale or grease deposits in the wash cabinet, these can be removed with a special cleaning agent (available from Miele). Follow the instructions on the packaging.

If you mainly use low temperature programs (< 120°F/50 °C), there is a risk of bacteria and unpleasant odors building up in the wash cabinet. To prevent this happening the dishwasher will automatically increase the temperature in the final rinse of the selected program after several programs using low temperatures have been run.

- Clean the filters in the wash cabinet regularly.

Cleaning the door and the door seal

Bacteria could build up on the door seal and the sides of the dishwasher door as these surfaces are outside the wash cabinet and are not accessed and cleaned by the spray arm jets.

- Wipe the door seals regularly with a damp cloth to remove food deposits.
- Wipe off any food or drink residues which may have dripped onto the sides of the dishwasher door before closing it.

Cleaning the door front

 If soiling remains longer, it may happen that the surfaces can become discolored or changed. Remove any soiling immediately.

- Clean the front with a solution of warm water and a little dishwashing liquid applied with a soft sponge. Wipe the surfaces dry using a soft cloth.

 Glass cleaners may be used to clean the exterior. However **do not** allow them to sit or "puddle", this can cause damage to the surface. **Remove the cleaner promptly.**

To better maintain your appliance avoid the following:

- Cleaning products containing soda, ammonia, acid, or chloride
- Descaling agents
- Abrasive cleaning products, such as scouring powder, scouring liquid, or pumice stones,
- Cleaners containing solvents
- Stainless steel cleaners
- Dishwasher cleaner
- Oven cleaners
- Glass cleaner
- Hard, abrasive brushes or sponges, e.g., pot scourers, brushes or sponges which have been previously used with abrasive cleaning agents
- Eraser sponges
- Sharp metal scrapers
- Steel wool
- Steam cleaning appliances

Cleaning and care

Filter system

The filter system in the base of the wash cabinet prevents food from being redeposited on dishes. It also protects the circulation pump from damage caused by foreign objects.

⚠ This dishwasher must not be used without all the filters in place!

Collection of coarse soil may cause the filters to clog. The level of soiling and time it takes before the filters need cleaning will vary depending on use.

The message *Check filters* will appear in the display after every 50 program cycles (factory default setting).

You can set the interval for the "Check filters" message to appear to a value between 30 and 60 program cycles (see "Settings menu - Check filters").

- Check the filter system.
- Clean it if necessary.
- Then confirm the message with **OK**.

The message will disappear.
The display will change to show the program selection menu.

Filter system

- Turn the dishwasher off.

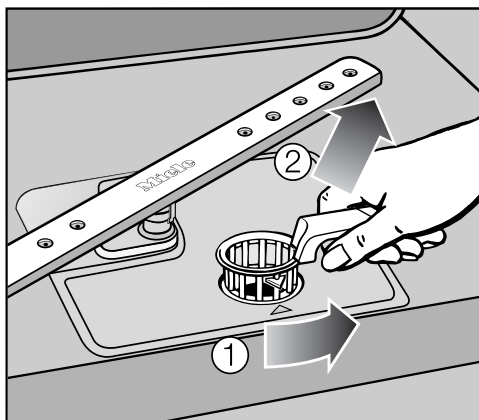

- Turn the handle counter-clockwise to release the filter system ①.
- Lift the filter system out of the dishwasher ②. Remove any coarse particles and rinse the filter well under running water. Use a nylon brush if necessary.

⚠ Ensure that coarse soil does not get into the circulation system and cause a blockage.

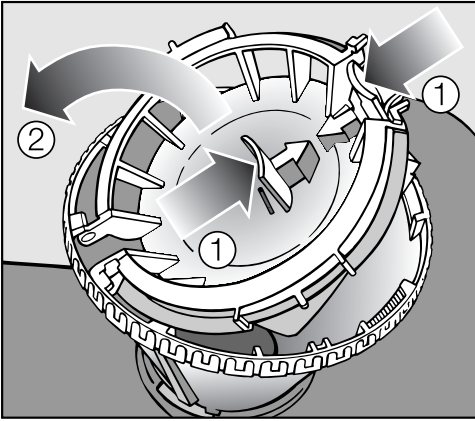

To clean the inside of the filter, the flap must be opened:

- Press catches ① together in the direction of the arrows as shown, and open the filter ②.
- Rinse all the filters under running water.
- Then close the flap so that the catch engages.

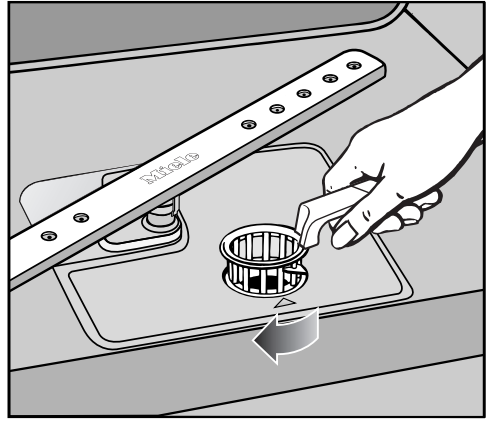

- Replace the filter system so that it lies flat in the base of the wash cabinet.
- Then turn the handle clockwise until both arrows point towards each other. This will lock the filter system in place.

 Take care when you are fitting the filter system that it is secured in position correctly. Otherwise coarse soil could get into the circulation system and cause a blockage.

Cleaning and care

Cleaning the spray arms

Particles of food can get stuck in the spray arm jets and bearings. The spray arms should therefore be inspected and cleaned regularly (approx. every 4 - 6 months).

- Turn the dishwasher off.

Remove the spray arms as follows:

- Take out the cutlery tray (if your dishwasher is fitted with one).
- Push the **top** spray arm upwards to engage the inner ratchet. Then unscrew the spray arm.

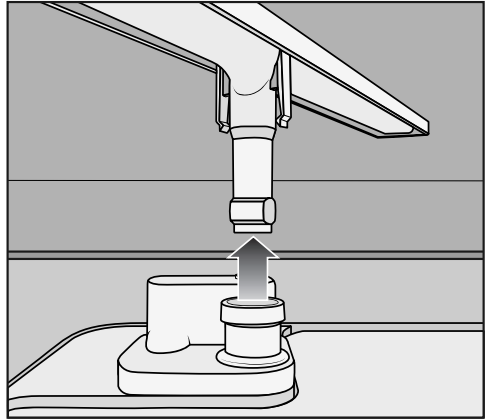

- Pull the **lower** spray arm firmly upwards to remove it.

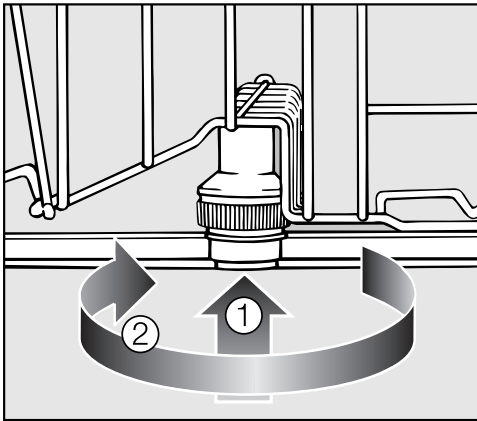

- Push the **middle** spray arm upwards ① to engage the ratchet. Then unscrew the spray arm ②.
- Remove the lower basket.

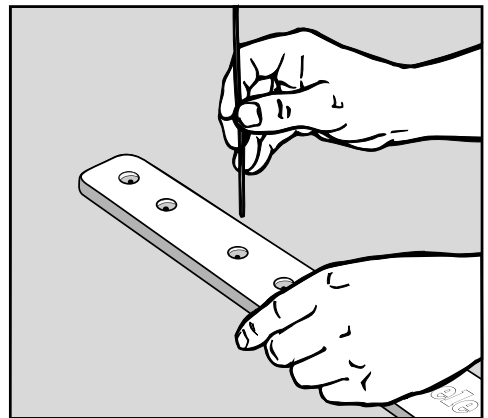

- Use a pointed object to push the food particles that are stuck in the spray arm jets into the spray arm.
- Rinse the spray arms thoroughly under running water.
- Replace the spray arms and check that they rotate freely.

Frequently Asked Questions

With the help of the following guide, minor faults in the performance of the appliance, some of which may result from incorrect operation, can be put right without contacting Miele Service. This will save time and money.

The following guide may help you to find the reason for a fault, and to correct it. You should, however, note the following:



 Unauthorized or incorrect repairs could cause personal injury or damage to the appliance.

Repair work to electrical appliances must only be carried out by a suitably qualified and competent person in strict accordance with current local and national safety regulations. The manufacturer cannot be held liable for unauthorized work.

Technical problems

Problem	Possible cause and solution
The display remains dark after the dishwasher has been switched on with the  sensor button.	The dishwasher is not plugged in. ■ Insert the plug.
	The circuit breaker has tripped. ■ Reset the fuse (see data plate for the correct fuse rating).
The dishwasher stops during a program.	The circuit breaker has tripped. ■ Reset the fuse (see data plate for the correct fuse rating). ■ If the circuit breaker trips again, contact Miele Service.

Frequently Asked Questions

Problem	Possible cause and solution
<p>The buzzer sounds. One of the following fault messages appears in the display:</p>	<p>Before fixing the fault:</p> <ul style="list-style-type: none"> ■ Turn the dishwasher off using the Ⓛ sensor button.
<p> Technical fault FXX</p>	<p>There may be a technical fault.</p> <p>After a few seconds:</p> <ul style="list-style-type: none"> ■ Turn the dishwasher back on. ■ Select the desired program. ■ Press the <i>Start</i> sensor button. <p>If the error message is displayed again, there is a technical fault.</p> <ul style="list-style-type: none"> ■ Contact Miele Service.
<p> Waterproof fault</p>	<p>The WaterProof System has reacted.</p> <ul style="list-style-type: none"> ■ Turn off the water supply. ■ Contact Miele Service.
<p> Technical fault F78</p>	<p>A fault has occurred in the circulation pump.</p> <ul style="list-style-type: none"> ■ Turn the dishwasher off for at least 30 seconds with the Ⓛ sensor button. ■ Turn the dishwasher back on. ■ Select the desired program. ■ Press the <i>Start</i> sensor button. <p>If the error message is displayed again, there is a technical fault.</p> <ul style="list-style-type: none"> ■ Contact Miele Service.

Frequently Asked Questions

Problem	Possible cause and solution
The buzzer sounds. One of the following fault messages appears in the display:	Before fixing the fault: <ul style="list-style-type: none">■ Turn the dishwasher off using the Ⓛ sensor.
Fault auto. door closing	The door may be obstructed by an item inside the appliance. <ul style="list-style-type: none">■ If this is the case, remove the item and switch the dishwasher on again.■ If the same error message appears again, contact Miele Technical Service.
Fault auto. door opening	There may be a technical fault. <ul style="list-style-type: none">■ Open the door manually.■ If the same error message appears again, contact Miele Technical Service.

Frequently Asked Questions

Water intake fault

Problem	Possible cause and solution
<p>The buzzer sounds. One of the following fault messages appears in the display:</p>	
<p>☞ Water intake fault Open the water supply</p>	<p>The water supply is turned off.</p> <ul style="list-style-type: none"> ■ Turn on the water supply fully.
<p>☞ Water intake</p>	<p>Before fixing the fault:</p> <ul style="list-style-type: none"> ■ Turn the dishwasher off using the Ⓢ sensor. <p>There is a problem with the water intake.</p> <ul style="list-style-type: none"> ■ Turn on the water supply fully and start the program again. ■ Clean the water intake filter (see "Frequently asked questions"). ■ The flow pressure at the connection point is lower than 7.25 psi. Contact a plumber.
<p>The following message appears in the display during the Energy Saver program:</p> <p>ⓘ Intake temp. too low</p>	<p>The intake water has not reached the required temperature of 120°F (45°C) (see "Water connection, Water intake").</p> <ul style="list-style-type: none"> ■ Start the program again. ■ If the fault message appears again, select a different program.

Water drainage fault

Problem	Possible cause and solution
<p>The buzzer sounds. The following fault message appears in the display:  Drain fault</p>	<p>Before fixing the fault:</p> <ul style="list-style-type: none"> ■ Turn the dishwasher off with the ⏻ button. <p>There is a problem with the water intake. There might be water in the wash cabinet.</p> <ul style="list-style-type: none"> ■ Clean the filter system (see "Cleaning and care - Filter system"). ■ Clean the drain pump (see "Frequently asked questions"). ■ Clean the non-return valve (see "Frequently asked questions"). ■ Remove any kink or loop in the drain hose.

Frequently Asked Questions

General problems

Problem	Possible cause and solution
This display is dark.	The dishwasher has switched off automatically to save energy. ■ Turn the dishwasher on again using the ① sensor button.
The interior lighting does not switch on when the door is opened.	The interior lighting has been switched off. ■ Switch the lighting back on again (see "Settings menu - BrilliantLight").
Detergent residue is left in the dispenser at the end of a program.	The dispenser was still damp when detergent was added. ■ Make sure the dispenser is dry before adding detergent.
The dispenser cover cannot be closed.	Detergent residue is blocking the latch. ■ Remove the detergent residue.
The inside of the door and/or the interior walls are wet after a program has finished.	This is caused by the drying system and does not indicate a fault. The moisture will dissipate after a while.
Water remains in the wash cabinet at the end of a program.	Before fixing the fault: ■ Turn the dishwasher off using the ① sensor button.
	The filter system in the wash cabinet is clogged. ■ Clean the filter system (see "Cleaning and care - Filter system").
	The drain pump or non-return valve is blocked. ■ Clean the drain pump or the non-return valve (see "Frequently asked questions").
	The drain hose is kinked. ■ Remove the kink.

Frequently Asked Questions

Noises

Problem	Possible cause and solution
There is a knocking noise in the wash cabinet.	A spray arm is hitting the dishes. ■ Interrupt the program, and rearrange the items which are obstructing the spray arm.
There is a rattling noise in the wash cabinet.	Dishes is moving around in the wash cabinet. ■ Interrupt the program and rearrange loose pieces. A foreign object (e.g., a cherry pit) has become lodged in the drain pump. ■ Remove the foreign object from the drain pump (see "Maintenance - Cleaning the drain pump and non-return valve").
There is a knocking noise from the water pipe	This may be caused by the installation or the diameter of the water pipe. ■ This has no influence on dishwasher function. If in doubt, contact a suitably qualified plumber.

Frequently Asked Questions

Poor cleaning results

Problem	Possible cause and solution
The dishes are not clean.	The dishes were not loaded correctly. ■ See notes in "Loading the dishwasher".
	The program was not powerful enough. ■ Select a more intensive program (see "Program overview").
	There is some stubborn soiling even though most of the dishes is only lightly soiled (e.g., with tea stains). ■ Use the <i>Automatic</i> program option (see "Settings menu - Sensor wash").
	Not enough detergent was dispensed. ■ Use more detergent, or change your detergent.
	Items are blocking the path of the spray arms. ■ Rearrange the items so that the spray arms can rotate freely.
	The filter system in the base of the wash cabinet is not clean or is not correctly fitted. This may cause the spray arm jets to get blocked. ■ Clean and/or fit the filter system correctly. ■ Clean the spray arm jets if necessary (see "Cleaning and care - Cleaning the spray arms").
	The non-return valve is open and blocked. Dirty water has flowed back into the wash cabinet. ■ Clean the drain pump and the non-return valve (see "Frequently asked questions").
Smearing appears on glassware and cutlery. There is a bluish sheen on the surface of glassware; film can be wiped off.	The rinse aid dosage is set too high. ■ Reduce the dosage (see "Settings menu - Rinse aid").

Frequently Asked Questions

Problem	Possible cause and solution
Dishes is not dry or cutlery and glasses are spotty.	The rinse aid dosage is set too low or the rinse aid reservoir is empty. <ul style="list-style-type: none"> ■ Replenish the reservoir, increase the dosage, or change the brand of rinse aid (see "Before using for the first time - Rinse aid").
	Dishes was taken out of the cabinet too soon. <ul style="list-style-type: none"> ■ Leave it in for longer (see "Operation").
	Combination tabs have been used which have impaired drying performance. <ul style="list-style-type: none"> ■ Change your detergent, or replenish the rinse aid (see "Before using for the first time - Rinse aid").
Glasses have a brownish-blue discoloration; the deposit cannot be wiped off.	Detergent deposits. <ul style="list-style-type: none"> ■ Switch to another detergent.
Glasses are dull and discolored; the deposit cannot be wiped off.	The glassware is not dishwasher-safe. The surfaces are affected. <ul style="list-style-type: none"> ■ There is no remedy. Purchase glassware which is dishwasher-safe.
Tea or lipstick stains have not been completely removed.	The wash temperature of the selected program was too low. <ul style="list-style-type: none"> ■ Select a program with a higher wash temperature.
	The bleaching effect of the detergent is too low. <ul style="list-style-type: none"> ■ Switch to another detergent.
Plastic parts are discolored.	Natural dyes, e.g., from carrots, tomatoes, or ketchup may be the cause. The amount of detergent used or its bleaching effect was not sufficient to deal with natural dyes. <ul style="list-style-type: none"> ■ Use more detergent (see "Operation - Detergent"). Discoloration is irreversible.

Frequently Asked Questions

Problem	Possible cause and solution
<p>White residue is visible on dishes and cutlery, clouding occurs on glassware; this film can be wiped off.</p>	<p>The rinse aid dosage is too low.</p> <ul style="list-style-type: none"> ■ Increase the dosage (see "Settings menu, Rinse aid").
	<p>The salt reservoir is empty.</p> <ul style="list-style-type: none"> ■ Fill the salt reservoir (see "Before using for the first time, Dishwasher salt").
	<p>The salt reservoir cap has not been screwed on correctly.</p> <ul style="list-style-type: none"> ■ Replace it, making sure that it screws back on correctly.
	<p>An unsuitable Tab detergent has been used.</p> <ul style="list-style-type: none"> ■ Change your detergent.
	<p>The softener assembly is programmed too low for the water hardness level.</p> <ul style="list-style-type: none"> ■ Program the softener assembly to a higher water hardness level (see "Settings menu, Water hardness").
<p>There are rust stains on the cutlery.</p>	<p>The affected items are not corrosion resistant.</p> <ul style="list-style-type: none"> ■ There is no remedy. Purchase cutlery which is dishwasher-safe.
	<p>A program was not run after dishwasher salt was added. Traces of salt have got into the wash cycle.</p> <ul style="list-style-type: none"> ■ Always run the <i>QuickIntenseWash</i> program with the <i>Short</i> programming option selected and without any dishes in the dishwasher after adding dishwasher salt.
	<p>The salt reservoir cap has not been screwed on correctly.</p> <ul style="list-style-type: none"> ■ Replace it, making sure that it screws back on correctly.

Cleaning the drain pump and non-return valve

If the water has not been pumped away at the end of a program, the drain pump or the non-return valve might be blocked. They are, however, easy to clean.

- Disconnect the dishwasher from the electrical supply. Turn off the dishwasher and withdraw the plug.
- Take the filter system out of the wash cabinet (see "Cleaning and care, Cleaning the filters").
- Scoop the water out of the wash cabinet using a suitable container or utensil.

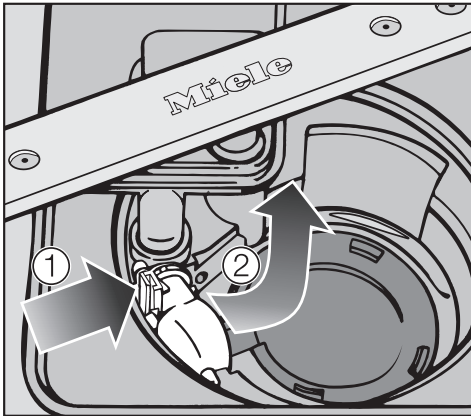

- Press the catch for the non-return valve inwards ①.
- Tilt the non-return valve inwards until it is released ②.
- Rinse it thoroughly under running water and remove any dirt from the non-return valve.

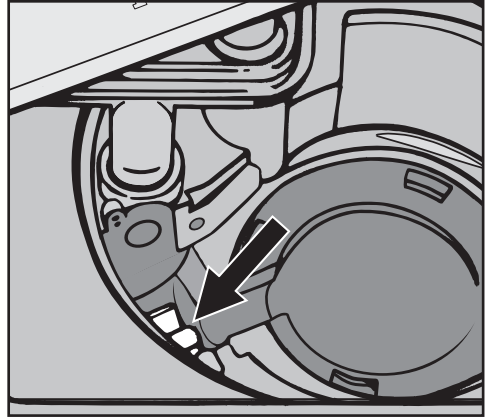

The drain pump is located underneath the non-return valve (see arrow).

- Remove all foreign objects from the drain pump (glass or bone splinters). Before returning the non-return valve, check that the drain pump is not blocked. Spin the impeller several times in both directions to check for obstructions.
- Carefully reinsert the non-return valve and secure it with the locking clamp.

⚠ Make sure the locking clamp clicks into place!

⚠ Be careful not to damage any delicate components when cleaning the drain pump and the non-return valve.

Customer service

Repairs

For problems that you cannot resolve on your own, please contact:

- your Miele dealer or
- Miele Service

The telephone number for Miele is listed at the back of these instructions.

In the event of a fault which you cannot correct yourself please contact the Miele Service Department at the phone number on the back of this booklet.

Warranty

For more information, please refer to the included warranty.

MieleCare (USA only)

MieleCare, our Extended Service Contract program, gives you the assurance of knowing that your appliance investment is covered by 5 years of worry free ownership.

MieleCare is the only Extended Service Contract in the industry that guarantees repairs by a Miele Authorized Service Provider using genuine Miele parts. Only genuine Miele parts installed by factory trained professionals can guarantee the safety, reliability, and longevity of your Miele appliance.

Please note that unless expressly approved in writing by Miele's Service department, Extended Service Contracts offered by other providers for Miele products will not be recognized by Miele. Our goal is to prevent unauthorized (and untrained) service personnel from working on your Miele products, possibly doing further damage to them, you and/or your home.

To learn more about **MieleCare** Extended Service Contracts, please contact your appliance dealer or visit us online at:

<http://www.mieleusa.com>

Dishwasher detergent and rinse aid, as well as cleaning and care products, are available as optional accessories.

All the products are designed for use with Miele dishwashers.

These and many other useful products can be ordered from a Miele dealer or via the Miele Webshop (see end of this booklet for contact details).

Dishwasher detergent, rinse aid, and salt

When you decide to buy a Miele dishwasher, you choose excellent quality and performance. However, ensuring that your dishwasher always delivers the best possible results will also depend on your choice of dishwasher detergent, rinse aid, and dishwasher salt, as cleaning results can vary depending on the brand used.

With Miele products, you can be sure of optimum results as these products have been specially designed for Miele dishwashers.

Detergent tabs

- Sparkling results even with stubborn food deposits
- Combination product with other components such as rinse aid, salt, and glass protection additives
- Phosphate-free - kind to the environment
- Water-soluble wrapping - no need to unwrap

Powder detergent

- With active oxygen for thorough cleaning
- With enzymes which are effective even in low temperature programs
- With glass protection against corrosion

Rinse aid

- For sparkling glasses
- Helps dishware to dry
- With glass protection against corrosion
- Specially designed cap for accurate, easy dispensing

Dishwasher salt

- Prevents lime scale on dishware and in the appliance
- Extra coarse-grained

Optional accessories

Dishwasher care products

Miele cleaning and care products provide optimum care for your dishwasher.

Dishwasher cleaner

- Cleans the dishwasher effectively and thoroughly
- Removes grease, bacteria, and unpleasant odors
- Ensures excellent dishwashing results

Dishwasher descaler

- Removes heavy lime scale deposits
- Mild and gentle with natural citric acid

Dishwasher conditioner

- Removes odors, lime scale, and light deposits
- Maintains the elasticity and leak tightness of the seals

Dishwasher freshener

- Neutralizes unpleasant odors
- Fresh, pleasant lime and green tea scent
- Easy to attach to the dishwasher basket
- Very economical, lasts for 60 wash cycles

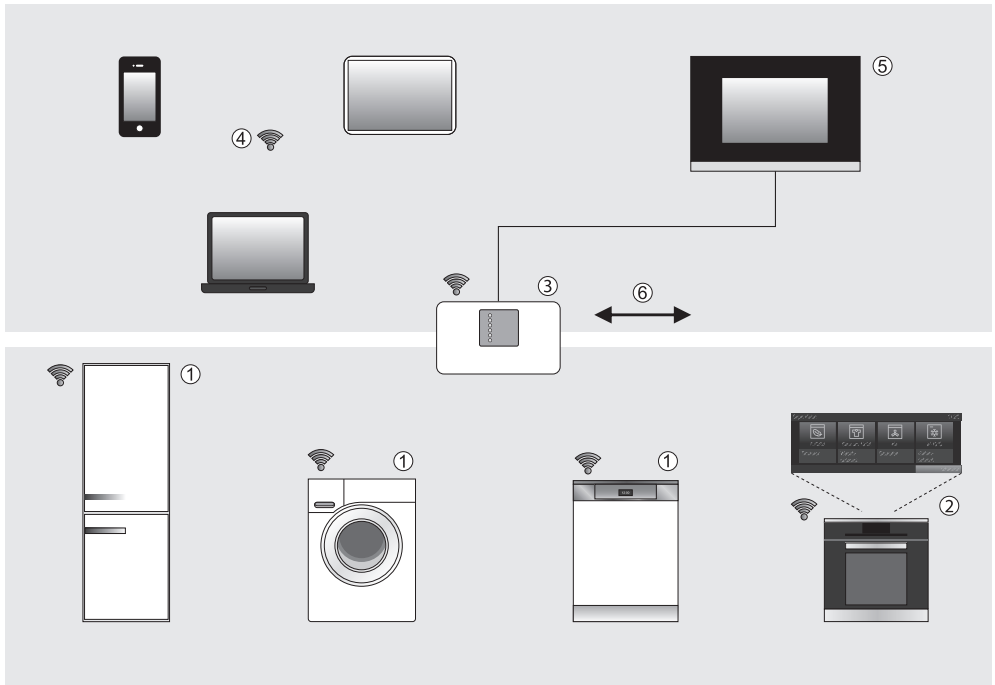

- ① Miele@home-compatible appliance
- ② Miele@home-compatible appliance with SuperVision functionality
- ③ WLAN router
- ④ Mobile devices (Smartphone, Tablet PC, Notebook)
- ⑤ Connection to home automation systems
- ⑥ Internet connection

Your home device ① / ② is network-enabled.

In order to connect your home device to the network, a WLAN module or a WLAN stick is required (depending on the home device integrated, supplied, or acquired as optional accessory).

When using a WLAN router ③ and the Miele@mobile app, your home device can be linked to the Miele@home system.

Appliances with network capability and linked to the Miele@home system send information about their operating status and transmit relevant program sequence data to the apps of the mobile device ④ or the master appliance ②, an oven with SuperVision function, for example.

Displaying information, controlling appliances

- Mobile devices ④ with Miele@mobile app
Smartphone, Tablet PC or Notebook can be used to display status information about the appliances; you may also activate certain control functions. Additional application options of the Miele@home app can be found in the information about the integrated respective appliances.
- SuperVision master appliance ②
The status of some network-enabled appliances can be shown on the display of other network-enabled appliances.

WLAN

Tip: Before installing the appliance in its final location, ensure the signal strength is sufficient for your WLAN network.

To connect appliances with integrated WLAN module to your WLAN network, you must first activate the network function (see "Settings").

To connect appliances with external WLAN module or WLAN stick to your WLAN network, you must first insert the WLAN module or install the WLAN stick (see "Installation instructions of the WLAN module or WLAN stick").

Additional information

Separate installation and operating instructions are enclosed with the accessories.

Additional information regarding Miele@home is available on the Miele Website and in the instruction manuals of the individual Miele@home components.

Miele@mobile App

The Miele@mobile App is available to download free of charge from the Apple App Store® or from the Google Play Store™.



Installation Instructions

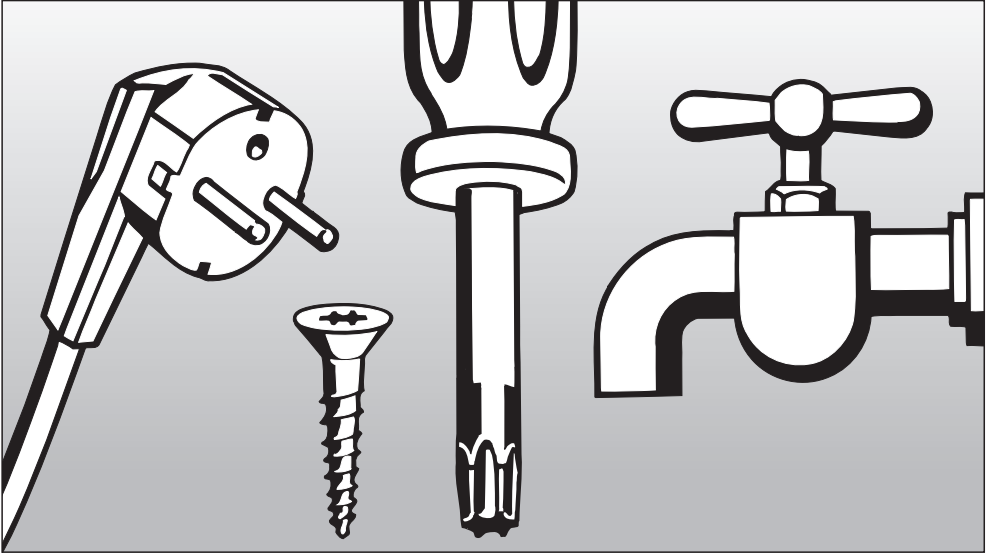

Please refer to the Installation Diagram supplied with these instructions.
To comply with IEC sound testing protocols, please contact Miele for additional instructions.

Information is subject to change. Please refer to our website to obtain the most current product specification, technical & warranty information.

Electrical connection

Installation, repairs and other work by unqualified persons could be dangerous.

Check that the voltage, frequency and fuse rating shown on the data plate match the household mains supply.

The power outlet must be accessible after installation. Do not use an extension cord to connect the dishwasher to the mains. Danger of overheating! See data plate on the right side of the door.

A damaged power cord must only be replaced with a genuine Miele cord by a Miele service technician.

Improper connection of the equipment grounding conductor can result in electric shock.

Do not modify the plug provided with the appliance; if it will not fit the outlet, have a proper outlet installed by a qualified electrician.

If there is any question concerning the proper electrical connection or grounding of this appliance to the powersupply, please consult a licensed electrician or call Miele's Technical Service Department:

USA: 1-800-999-1360

CDN: 1-800-565-6435

Grounding instructions

THIS APPLIANCE MUST BE GROUNDED.

In the event of a malfunction or breakdown, grounding will reduce the risk of electric shock by providing a path of least resistance for the electrical current. This appliance is equipped with a cord having an equipment grounding conductor and a grounding plug. The plug must be plugged into an appropriate outlet that is installed and grounded in accordance with all local codes and ordinances.

Specifications

The dishwasher comes equipped with a 4 ft (1.2 m) powercord (measured from the rear of the dishwasher) with a molded plug for connection to 120 V, 60 Hz, 15 A grounded receptacle.

Electrical connection

Hardwired electrical connection

It is possible to hardwire this appliance to an existing power cable.

CAUTION: Before servicing, disconnect the power supply by either removing the fuse, shutting off the power main or manually "tripping" the circuit breaker.

Installation work and repairs should only be performed by a qualified technician in accordance with all applicable codes and standards. Repairs and service by unqualified persons could be dangerous and the manufacturer cannot be held responsible.

Before connecting the appliance to the power supply, make sure that the voltage and frequency listed on the data plate correspond with the household electrical supply. This data must correspond to prevent machine damage. Consult an electrician if in doubt.

GROUNDING INSTRUCTIONS

THIS APPLIANCE MUST BE GROUNDED.

This appliance must be connected to a grounded metal, permanent wiring system, or an equipment-grounding conductor must be run with the circuit conductors and connected to the equipment-grounding terminal or lead on the appliance.

Prior to making a hardwire connection to the terminal, remove the power cord. Otherwise there will be a risk of electric shock from the attached plug.

An existing flexible supply cord or cable shall have a minimum thickness of AWG 14.

120 V, 60 Hz, 15 A fuse rating

Black wire (live): connect to L

White wire (neutral): connect to N

Green wire (ground): connect to 

After attaching the permanent power supply cord, check that all screws on the terminal block and the strain relief are tightened.

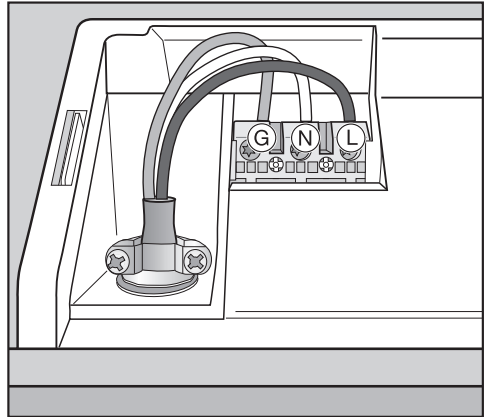

Water connection

Water intake

 Water in the dishwasher must not be used as drinking water.

- The dishwasher may be connected to a cold or hot water supply up to a maximum of 140°F/60°C.

For reduced energy consumption, we recommend a cold water connection. We recommend connection to a hot water supply only if it is economical, e. g. a solar-powered supply with recirculation line. When connected to a hot water supply, all program phases which would otherwise be carried out with cold water will be carried out with hot water

- The Energy Saver program (if available) requires a hot water supply between 115°F/45°C (minimum) and 140°F/60°C (maximum). The higher the water intake temperature, the better the cleaning and drying results.
- The inlet hose is approx. 5 ft long. A 5 ft long flexible metal hose (pressure tested to 2030 psi) is available as an optional accessory if required.
- A faucet with a 3/8" male thread must be provided on site.
- This appliance is constructed to comply with ANSI/ASSE 1001 // IEC/EN/DIN 61770 // VDE 0700 Part 600, and may be connected to a suitable supply without an extra non-return valve if national regulations permit.

- Water pressure: Must be between 4.5 - 145 psi (0.3 - 10 bar) If the water pressure is lower than this, the fault message `Intake` will appear in the display (see "Frequently asked questions"). If the water pressure is too high, a pressure relief valve must be fitted.

After connecting the dishwasher to the water supply, check that the water intake is airtight.

 To avoid any damage to the appliance, the dishwasher must only be operated when it is connected to a fully vented plumbing system.

 The intake hose must not be shortened or damaged in any way as it contains electrical components (see illustration).

Drainage

- The machine comes equipped with a built-in non-return valve on the discharge side to prevent waste water from flowing back into the dishwasher.
- Take the drain line of the dishwasher and attach the drain line as high as possible under the counter rim of the kitchen sink before connecting the end to the drain. The loop will serve to prevent a backed up drain or large volume of water in the sink from siphoning back into the dishwasher.
- The dishwasher is supplied with approx. 5' 11" (1.5 m) of flexible drain hose with an internal diameter of 7/8" (22 mm).
- The drain hose can be extended using extensions and adapters. The drainage length must not be longer than 13' 1 1/2" (4 m) and the delivery head must not exceed 3' 3 3/8" (1 m).
- If the hose is to be directly fitted to the drainage outlet on site, use the hose clip supplied (see installation diagram).
- The hose can be directed to the left or the right of the appliance.
- The on-site connector for the drain hose can be adapted to different widths of hose. If the connector protrudes too far into the drain hose, it will need to be shortened. Otherwise the drain hose may become blocked.
- The drain hose must not be shortened.

 Make sure that there are no kinks in the hose, and that it is not squashed or stretched.

After servicing the appliance, ensure that the drain does not leak.

Venting the drain

If the on-site drain connection is situated lower than the guide path for the bottom basket rollers in the open door, the drain must be vented. Otherwise a siphoning effect during a program can cause the appliance to empty itself of water.

- To vent: open the dishwasher door fully.

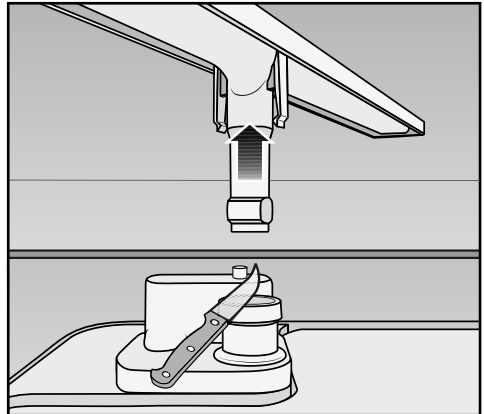

- Pull the lower spray arm firmly upwards to remove it.
- Cut off the top of the vent valve in the wash cabinet.

Sound emission testing

Prerequisites for sound emission tests

Load the dishwasher with **16 standard place settings** and use the *Normal* program.

Setup for sound emission tests

The dishwasher must be set up according to the following specifications.

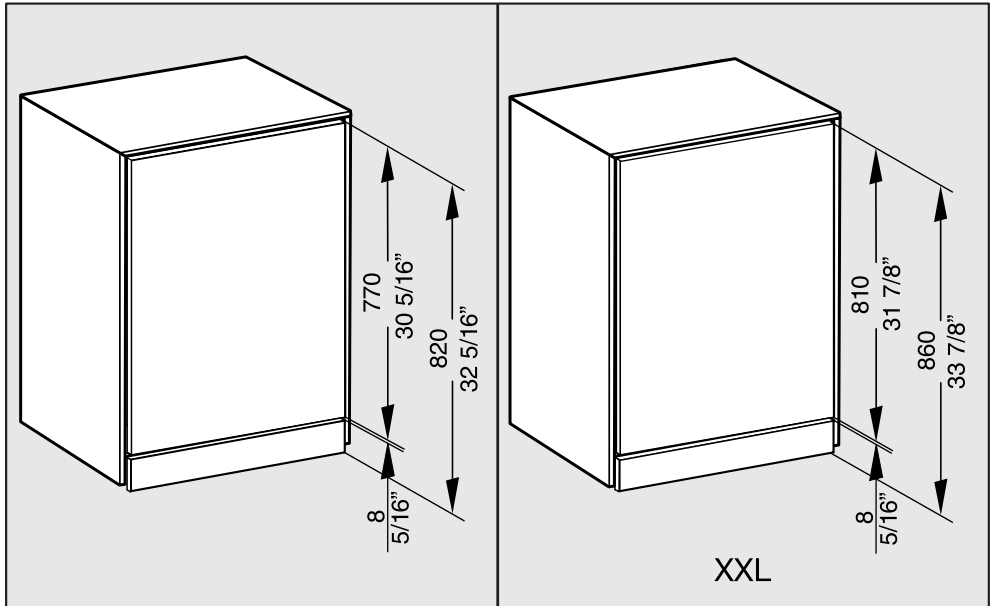

- Install the dishwasher into an analyzing unit.
- Secure the front panel.

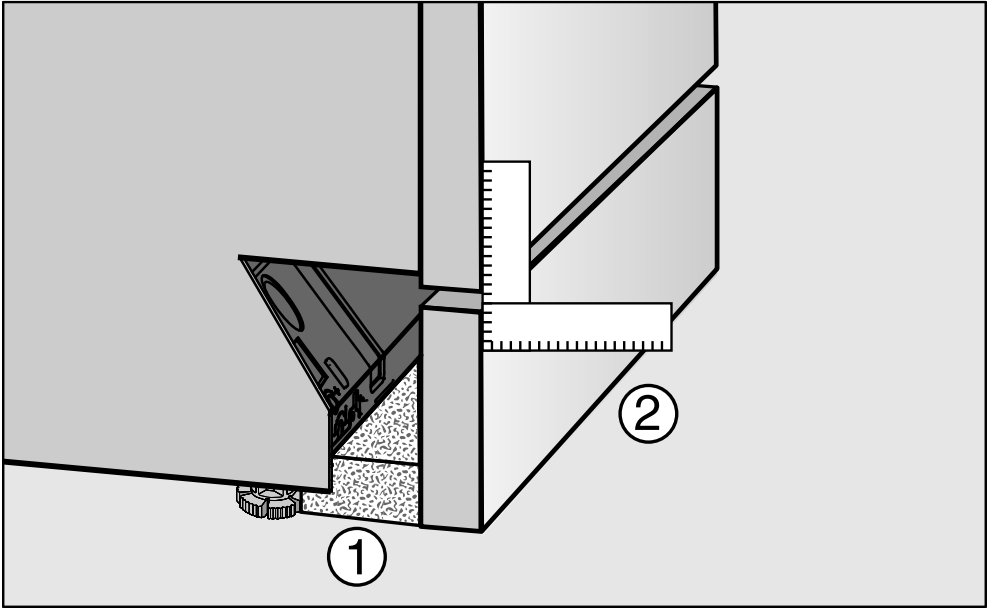

- Push the provided fleece strips (depending on model) under the toe-kick until it is flush with the appliance feet ①.
- Push the toe-kick into place in such a way that it is flush with the door front ②.

Sound emission testing

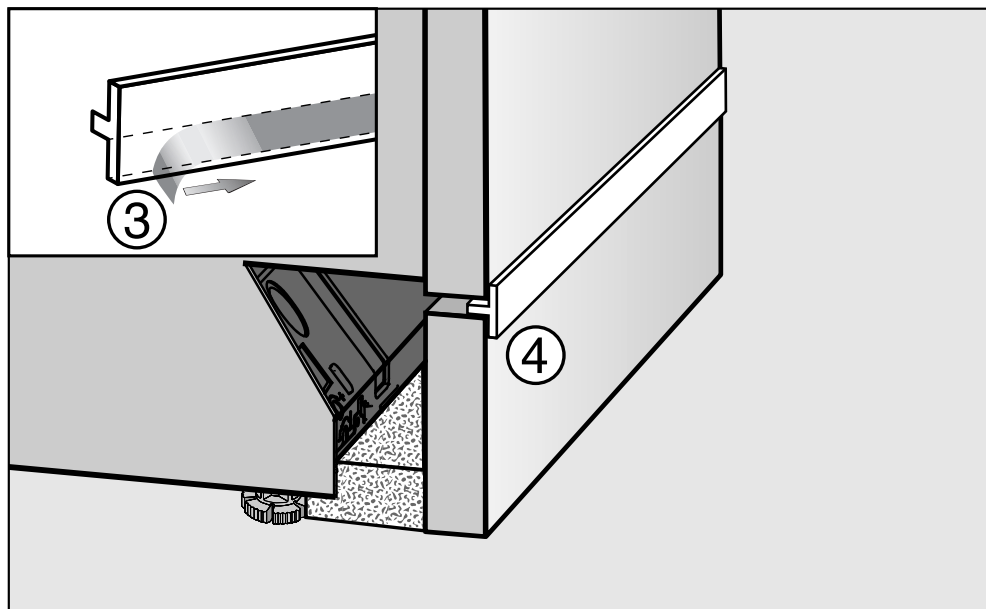

- Remove the protective film from the provided insulating strip (depending on model) ③.
- Push the insulating strip into the front top edge of the toe-kick ④.

Please have the model and serial number
of your appliance available before
contacting Technical Service.

The Miele logo consists of the word "Miele" in a bold, white, sans-serif font, set against a solid black rectangular background.

U.S.A.

Miele, Inc.

National Headquarters

9 Independence Way
Princeton, NJ 08540
Phone: 800-843-7231
Fax: 609-419-4298
www.mieleusa.com

Technical Service & Support

Nationwide

Phone: 800-999-1360
Fax: 888-586-8056
TechnicalService@mieleusa.com

International Headquarters

Miele & Cie. KG
Carl-Miele-Straße 29
33332 Gütersloh
Germany

Canada

Importer
Miele Limited

Headquarters and Miele Centre

161 Four Valley Drive
Vaughan, ON L4K 4V8
www.miele.ca

Customer Care Centre

Phone: 800-565-6435
905-532-2272
customercare@miele.ca

G 6930 / G 6935



en-US

M.-Nr. 10 546 920 / 00