

SHARP®

MICROWAVE OVEN OPERATION MANUAL

MODELS

R-323T / R-423T

Followed by letter indicating color
KC = black, WC = white, SC = stainless steel

CONTENTS

• For Customer Assistance	2
• Precautions to Avoid Possible Exposure to Excessive Microwave Energy	2
• Consumer Limited Warranty	3
• Product Information Card	3
• Important Safety Instructions	4
• Installation Guide	5
• Grounding Instructions	5
• Information You Need to Know	6
• Part Names	7-8
• How to Set the Oven Controls	9-14
• Cleaning and Care	15
• Specifications.....	15



READ ALL INSTRUCTIONS CAREFULLY BEFORE USING THE OVEN.

FOR CUSTOMER ASSISTANCE

To aid in reporting this microwave oven in case of loss or theft, please record below the model number and serial number located on the unit. We also suggest you record all the information listed and retain for future reference.

MODEL NUMBER _____	SERIAL NUMBER _____
DATE OF PURCHASE _____	
DEALER _____	TELEPHONE _____
SERVICER _____	TELEPHONE _____

TO PHONE:

DIAL 1-800-BE-SHARP (237-4277) for :

SERVICE (for your nearest Sharp Authorized Servicer)

PARTS (for your authorized parts distributor)

ADDITIONAL CUSTOMER INFORMATION

DIAL 1-800-642-2122 for :

ACCESSORIES and COOKBOOK

TO WRITE:

Sharp Electronics Corporation

Customer Assistance Center

1300 Naperville Drive

Romeoville, IL 60446-1091

TO ACCESS INTERNET: www.sharppusa.com

Please provide the following information when you write or call: model number, serial number, date of purchase, your complete mailing address (including zip code), your daytime telephone number (including area code) and description of the problem.

800-570-3355

PRECAUTIONS TO AVOID POSSIBLE EXPOSURE TO EXCESSIVE MICROWAVE ENERGY

- (a) Do not attempt to operate this oven with the door open since open-door operation can result in harmful exposure to microwave energy. It is important not to defeat or tamper with the safety interlocks.
- (b) Do not place any object between the oven front face and the door or allow soil or cleaner residue to accumulate on sealing surfaces.
- (c) Do not operate the oven if it is damaged. It is particularly important that the oven door close properly and that there is no damage to the: (1) door (bent), (2) hinges and latches (broken or loosened), (3) door seals and sealing surfaces.
- (d) The oven should not be adjusted or repaired by anyone except properly qualified service personnel.

CONSUMER LIMITED WARRANTY

SHARP ELECTRONICS CORPORATION warrants to the first consumer purchaser that this Sharp brand product (the "Product"), when shipped in its original container, will be free from defective workmanship and materials, and agrees that it will, at its option, either repair the defect or replace the defective Product or part thereof with a new or remanufactured equivalent at no charge to the purchaser for parts or labor for the period(s) set forth below.

This warranty does not apply to any appearance items of the Product nor to the additional excluded item(s) set forth below nor to any Product the exterior of which has been damaged or defaced, which has been subjected to improper voltage or other misuse, abnormal service or handling, or which has been altered or modified in design or construction.

In order to enforce the rights under this limited warranty, the purchaser should follow the steps set forth below and provide proof of purchase to the servicer.

The limited warranty described herein is in addition to whatever implied warranties may be granted to purchasers by law. ALL IMPLIED WARRANTIES INCLUDING THE WARRANTIES OF MERCHANTABILITY AND FITNESS FOR USE ARE LIMITED TO THE PERIOD(S) FROM THE DATE OF PURCHASE SET FORTH BELOW. Some states do not allow limitations on how long an implied warranty lasts, so the above limitation may not apply to you.

Neither the sales personnel of the seller nor any other person is authorized to make any warranties other than those described herein, or to extend the duration of any warranties beyond the time period described herein on behalf of Sharp.

The warranties described herein shall be the sole and exclusive warranties granted by Sharp and shall be the sole and exclusive remedy available to the purchaser. Correction of defects, in the manner and for the period of time described herein, shall constitute complete fulfillment of all liabilities and responsibilities of Sharp to the purchaser with respect to the Product, and shall constitute full satisfaction of all claims, whether based on contract, negligence, strict liability or otherwise. In no event shall Sharp be liable, or in any way responsible, for any damages or defects in the Product which were caused by repairs or attempted repairs performed by anyone other than an authorized servicer. Nor shall Sharp be liable or in any way responsible for any incidental or consequential economic or property damage. Some states do not allow the exclusion of incidental or consequential damages, so the above exclusion may not apply to you.

THIS WARRANTY GIVES YOU SPECIFIC LEGAL RIGHTS. YOU MAY ALSO HAVE OTHER RIGHTS WHICH VARY FROM STATE TO STATE.

Your Product Model Number & Description:

R-323TKC/TWC, R-423TKC/TWC Home Use Carousel Microwave Oven. (Be sure to have this information available when you need service for your Product.)

Warranty Period for this Product:

One (1) year parts and labor. The warranty period continues for an additional four (4) years, for a total of five (5) years, with respect to the magnetron tube in the Product for parts only; labor and service are not provided free of charge for this additional period

Additional Item(s) Excluded from Warranty Coverage (if any):

Non-functional accessories, turntable and light bulb.

What to do to Obtain Service:

Call Sharp toll free at 1-800-BE-SHARP (1-800-237-4277) for instruction in servicing your microwave oven. Be sure to have **Proof of Purchase** available. If you ship the Product, be sure it is insured and packaged securely.

TO OBTAIN SUPPLY, ACCESSORY OR PRODUCT INFORMATION, CALL 1-800-BE-SHARP OR VISIT www.sharppusa.com. SAVE THE PROOF OF PURCHASE AS IT IS NEEDED SHOULD YOUR OVEN EVER REQUIRE WARRANTY SERVICE.

PRODUCT INFORMATION CARD

The product information card which is on the inside of the microwave oven carton should be completed within ten days of purchase and returned. We will keep it on file and help you access the information in case of loss, damage or theft. This will also enable us to contact you in the unlikely event that any adjustments or modifications are ever required for your oven.

IMPORTANT SAFETY INSTRUCTIONS

When using electrical appliances basic safety precautions should be followed, including the following:

WARNING - To reduce the risk of burns, electric shock, fire, injury to persons or exposure to excessive microwave energy:

1. **READ ALL INSTRUCTIONS BEFORE USING THE APPLIANCE.**
2. Read and follow the specific “**PRECAUTIONS TO AVOID POSSIBLE EXPOSURE TO EXCESSIVE MICROWAVE ENERGY**” on inside front cover.
3. This appliance must be grounded. Connect only to properly grounded outlet. See “**GROUNDING INSTRUCTIONS**” on page 5.
4. Install or locate this appliance only in accordance with the provided installation instructions.
5. Some products such as whole eggs and sealed containers—for example, closed glass jars—are able to explode and should not be heated in this oven.
6. Use this appliance only for its intended use as described in this manual. Do not use corrosive chemicals or vapors in this appliance. This type of oven is specifically designed to heat, cook or dry food. It is not designed for industrial or laboratory use.
7. As with any appliance, close supervision is necessary when used by children.
8. To reduce the risk of fire in the oven cavity:
 - a. Do not overcook food. Carefully attend to appliance when paper, plastic or other combustible materials are placed inside the oven to facilitate cooking.
 - b. Remove wire twist-ties from paper or plastic bags before placing bag in oven.
 - c. **If materials inside the oven ignite, keep oven door closed, turn oven off and disconnect the power cord or shut off power at the fuse or circuit breaker panel.**
 - d. Do not use the cavity for storage purposes. Do not leave paper products, cooking utensils or food in the cavity when not in use.
9. Liquids, such as water, coffee or tea are able to be overheated beyond the boiling point without appearing to be boiling. Visible bubbling or boiling when the container is removed from the microwave oven is not always present. **THIS COULD RESULT IN VERY HOT LIQUIDS SUDDENLY BOILING OVER WHEN A SPOON OR OTHER UTENSIL IS INSERTED INTO THE LIQUID.**

To reduce the risk of injury to persons:

 - a. Do not overheat the liquid.
 - b. Stir the liquid both before and halfway through heating it.
 - c. Do not use straight-sided containers with narrow necks. Use a wide-mouthed container.
 - d. After heating, allow the container to stand in the microwave oven at least for 20 seconds before removing the container.
 - e. Use extreme care when inserting a spoon or other utensil into the container.
10. Do not heat oil or fat for deep-frying. It is difficult to control the temperature of oil in microwave oven.
11. Pierce foods with heavy skins such as potatoes, whole squash, apples and chestnuts before cooking.
12. The contents of feeding bottles and baby jars should be stirred or shaken and the temperature should be checked before serving in order to avoid burns.
13. Cooking utensils may become hot because of heat transferred from the heated food. Potholders may be needed to handle the utensil.
14. Do not cover or block any openings on the appliance.
15. Do not store or use this appliance outdoors. Do not use this product near water, for example, near a kitchen sink, in a wet basement, near a swimming pool, or similar locations.
16. Do not operate this appliance if it has a damaged cord or a plug, if it is not working properly or if it has been damaged or dropped.
17. Do not immerse cord or plug in water. Keep cord away from heated surface. Do not let cord hang over edge of table or counter.
18. Use only thermometers, which are specifically designed for use in microwave ovens.
19. Do not operate any heating or cooking appliance beneath this appliance.
20. Be certain the glass tray and roller rings are in place when you operate the oven.
21. This appliance should be serviced only by qualified service personnel, contact nearest authorized service facility for examination, repair, or adjustment.
22. When cleaning surfaces of door and oven that comes together on closing the door, use only mild, nonabrasive soaps, or detergents applied with a sponge or soft cloth.

SAVE THESE INSTRUCTIONS

INSTALLATION GUIDE

1. Make sure that all the packing materials are removed from the inside of the door.
2. Check the oven for any damage, such as misaligned or bent door, damaged door seals and sealing surface, broken or loose door hinges and latches and dents inside the cavity or on the door. If there is any damage, do not operate the oven but contact qualified service personnel.
3. This microwave oven must be placed on a flat, stable surface to hold its weight and the heaviest food likely to be cooked in the oven.
4. Do not place the oven where heat, moisture, or high humidity are generated, or near combustible materials.
5. For correct operation, the oven must have sufficient airflow. Allow 20cm of space above the oven, 10cm at back and 5cm at both sides. Do not cover or block any openings on the appliance. Do not remove feet on which oven stands.
6. Do not operate the oven without glass tray, roller support, and shaft in their proper positions.
7. Make sure that the power supply cord is undamaged and does not run under the oven or over any hot or sharp surface.
8. The socket must be readily accessible so that it can be easily unplugged in an emergency.

GROUNDING INSTRUCTIONS

This appliance must be grounded. In the event of an electrical short circuit, grounding reduces risk of electric shock by providing an escape wire for the electric current.

WARNING – Improper use of the grounding plug can result in a risk of electric shock.

Consult a qualified electrician or serviceman if the grounding instructions are not completely understood, or if doubt exists as to whether the appliance is properly grounded, and either:

- 1) If it is necessary to use an extension cord, use only a 3-wire extension cord that has a 3-blade grounding plug and a 3-slot receptacle that will accept the plug on the appliance. The marked rating of the extension cord shall be equal to or greater than the electrical rating of the appliance, or 2) Do not use an extension cord. If the power supply cord is too short, have a qualified electrician or serviceman install an outlet near the appliance.

Electrical Requirements

The electrical requirements are a 120 volt 60 Hz, AC only, 20 amp. It is recommended that a separate circuit serving only the oven be provided. The oven is equipped with a 3-prong grounding plug. It must be plugged into a wall receptacle that is properly installed and grounded.

Power Supply Cord

1. A short power supply cord is provided to reduce the risks resulting from becoming entangled in or tripping over a longer cord.
2. Longer cord sets or extension cords are available and may be used if care is exercised in their use.
3. If long cord or extension cord is used
 - a) The marked electrical rating of the cord set or extension cord should be at least as great as the electrical rating of the appliance.
 - b) The extension cord must be a grounding-type 3-wire cord, and The longer cord should be arranged so that it will not drape over the counter top or table top where it can be pulled on by children or tripped over unintentionally.

Notes:

If you have any questions about the grounding or electrical instructions, consult a qualified electrician or service person. Neither Sharp nor the dealer can accept any liability for damage to the oven or personal injury resulting from failure to observe the electrical connection procedures.

Radio or TV Interference

Should there be any interference caused by the microwave oven to your radio or TV, check that the microwave oven is on a different circuit, relocated the radio or TV as far away from the oven as feasible or check position and signal of receiving antenna.

Permanent and Correct Installation

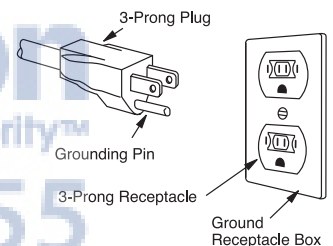

Temporary Use

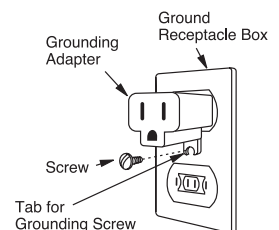

INFORMATION YOU NEED TO KNOW

UTENSILS GUIDE

This section lists which utensils can be used in the microwave, which ones have limited use for short periods, and which ones should not be used in the microwave.

RECOMMENDED

Microwave browning dish — Use to brown the exterior of small items such as steaks, chops, or pancakes. Follow the directions provided with your browning dish.

Microwaveable plastic wrap — Use to retain steam. Leave a small opening for some steam to escape and avoid placing it directly on the food.

Paper towels and napkins — Use for short-term heating and covering; these absorb excess moisture and prevent spattering. Do not use recycled paper towels, which may contain metal and could ignite.

Glass and glass-ceramic bowls and dishes — Use for heating or cooking.

Paper plates and cups — Use for short-term heating at low temperatures. Do not use recycled paper, which may contain metal and could ignite.

Wax paper — Use as a cover to prevent spattering.

Thermometers — Use only those labeled "Microwave Safe" and follow all directions. Check the food in several places. Conventional thermometers may be used on microwave food once the food has been removed from the oven.

LIMITED USE

Aluminum foil — Use narrow strips of foil to prevent overcooking of exposed areas. Using too much foil can damage your oven, so be careful. You should keep distance of 1 inch (2.54cm) between aluminum foil and cavity.

Ceramic, porcelain, and stoneware — Use these if they are labeled "Microwave Safe". If they are not labeled, test them to make sure they can be used safely.

Plastic — Use only if labeled "Microwave Safe". Other plastics can melt.

Not Recommended

Glass jars and bottles — Regular glass is too thin to be used in a microwave. It can shatter and cause damage and injury.

Paper bags — These are a fire hazard, except for popcorn bags that are designed for microwave use.

Styrofoam plates and cups — These can melt and leave an unhealthy residue on food.

Plastic storage and food containers — Containers such as margarine tubs can melt in the microwave.

Metal utensils — These can damage your oven. Remove all metal before cooking.

Note:

Should you wish to check if a dish is safe for microwaving, place the empty dish in the oven and microwave on HIGH for 30 seconds. A dish which becomes very hot should not be used.

COOKING TECHNIQUES

Your microwave makes cooking easier than conventional cooking, provided you keep these considerations in mind:

STIRRING

Stir foods such as casseroles and vegetables while cooking to distribute heat evenly. Food at the outside of the dish absorbs more energy and heats more quickly, so stir from the outside to the center. The oven will turn off when you open the door to stir your food.

ARRANGEMENT

Arrange unevenly shaped foods, such as chicken pieces or chops, with the thicker, meatier parts toward the outside of the turntable where they receive more microwave energy. To prevent overcooking, place delicate areas, such as asparagus tips, toward the center of the turntable.

SHIELDING

Shield food with narrow strips of aluminum foil to prevent overcooking. Areas that need shielding include poultry wing tips, the ends of poultry legs, and corners of square baking dishes. Use only small amounts of aluminum foil. Larger amounts can damage your oven.

TURNING

Turn foods over midway through cooking to expose all parts to microwave energy. This is especially important with large foods such as roasts.

STANDING

Foods cooked in the microwave build up internal heat and continue to cook for a few minutes after heating stops. Let foods stand to complete cooking, especially foods such as cakes and whole vegetables. Roasts need this time to complete cooking in the center without overcooking the outer areas. All liquids, such as soup or hot chocolate, should be shaken or stirred when cooking is complete. Let liquids stand a moment before serving. When heating baby food, stir well at removal and test the temperature before serving.

ADDING MOISTURE

Microwave energy is attracted to water molecules. Food that is uneven in moisture content should be covered or allowed to stand so that the heat disperses evenly. Add a small amount of water to dry food to help it cook

PART NAMES

MICROWAVE OVEN PARTS

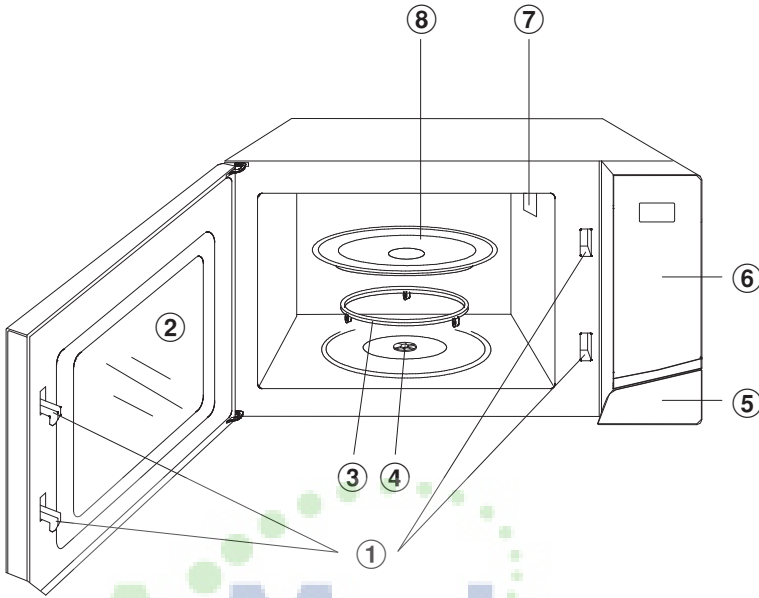

1. Door Safety Lock System

2. Oven Window

3. Roller ring

4. Shaft

5. Door Release Button

6. Control Panel

7. Wave Guide

(Please do not remove the mica plate covering the wave guide)

8. Glass tray

CONTROL PANEL

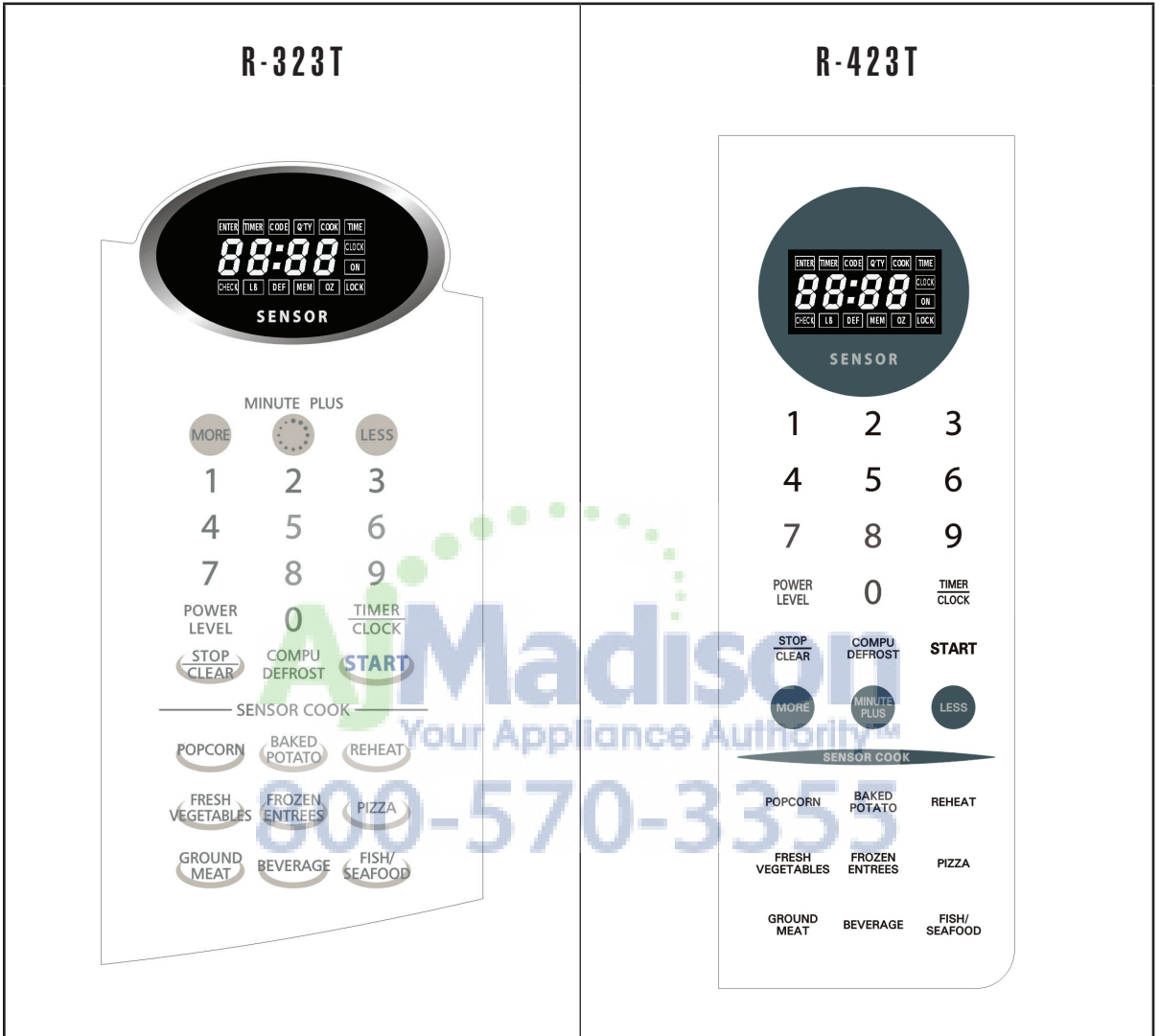

- MENU ACTION SCREEN - Cooking time, power, indicators and present time are displayed.
- MORE/LESS (+/-) - Used to add or reduce time from cooking.
- MINUTE PLUS - Press to add cooking time.
- NUMBER PADS - Press to set clock, cooking time or enter food weight.
- POWER LEVEL - Press to select microwave power level.
- TIMER/CLOCK - Timer functions independently, even while a cooking program is in process. You can also touch it to set the clock.
- STOP/CLEAR - Touch to stop the oven or reset the oven before setting a program.
- COMPU DEFROST - Easy settings to defrost according to weight entered.
- START - Press to start the oven.
- QUICK COOK BUTTONS - Instant settings to cook popular foods.

HOW TO SET THE OVEN CONTROLS



SIGNALS DURING OVEN SETTINGS

ONE SIGNAL: Oven accepts the entry.

TWO SIGNALS: Oven does not accept the entry, please check and try again.

SETTING THE CLOCK

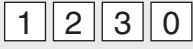
- Suppose you want to set the time of 12:30.

PROCEDURE	
1 Press TIMER/CLOCK pad for 3 seconds to set 12 hour clock; press it again to set the clock in 24-hour cycle.	
2 Touch number pads to enter clock time.	
3 Press TIMER/CLOCK pad again	

NOTE:

1. The clock default setting is 1:01.
2. If you enter a wrong time, the oven will beep to remind you after you pressed **TIMER/CLOCK** pad. During cooking, you can press **TIMER/CLOCK** pad to check the clock except during sensor cooking mode.



MICROWAVE COOKING

There are 6 power levels. Using lower power levels increases the cooking time which is recommended for foods such as cheese, milk and long slow cooking meats. Your oven can be programmed for 99 minutes 99 seconds (99.99).

You can select the power level by pressing **POWER LEVEL**:

PRESS	POWER LEVEL	DISPLAY
Once	100%	P-100
Twice	80%	P-80
3 times	60%	P-60
4 times	40%	P-40
5 times	20%	P-20
6 times	0%	P-00

- Suppose you want to cook for 5 minutes at 60% of microwave power.

PROCEDURE	
1 Press POWER LEVEL pad 3 times to set 60%.	
2 Touch number pads to enter desired cooking time	
3 Press START pad.	

NOTE:



1. If you prefer 100% power level, you can omit the first step.
2. You can check power level during cooking by pressing **POWER LEVEL**.
3. After total time has elapsed, signals sound and **END** appears in display. Press **STOP/CLEAR** or open oven door to clear **END** before starting another cooking function.

HOW TO SET THE OVEN CONTROLS

TIMER

- Suppose you want to time a 30 minutes phone call.

PROCEDURE

- 1** Press **TIMER/CLOCK** pad. 
- 2** Press the number pads to enter 30 minutes. 
- 3** Press **START** pad. 

NOTE:

1. The maximum time you can enter is 99 minutes and 99 seconds.
2. To cancel the timer, press **TIMER/CLOCK**, and then press **STOP/CLEAR** pad within 3 seconds.
3. The timer can be set in standby mode and cooking mode. However, during sensor cook, the timer function is unavailable.
4. When the countdown ends, the signal will sound to remind you.

AUTO REMINDER

After a cooking or a defrost program, beeps sound and **END** appears in display. Press **STOP/CLEAR** pad or open oven door to clear **END** before starting another cooking function.

MINUTE PLUS

This feature allows you to start the oven quickly at high power level.





Press the **MINUTE PLUS** pad once or repeatedly to set cooking time, the oven starts work at full power level immediately. The maximum cooking time can be set is 99 minutes and 59 seconds.

MULTI-STAGE COOKING

Your oven can be programmed for up to 2 microwave cooking program.

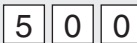
- Suppose you want to cook roast beef at 80% for 5 minutes and then continue to cook at 40% for 30 minutes.

PROCEDURE

- 1** Press **POWER LEVEL** twice for 80% power.  x 2
- 2** Use the number pads to enter cooking time. 
- 3** Press **POWER LEVEL** pad 4 times for 40% power.  x 6
- 4** Use the number pads to enter cooking time. 
- 5** Press **START** pad. 

CHILD LOCK

Use to prevent unsupervised operation of the oven by little children. The **CHILD LOCK** indicator will show on display screen, and the oven cannot be operated while the **CHILD LOCK** is set.

To set the **CHILD LOCK**: Press and hold the **STOP/CLEAR** pad for 3 seconds, a beep sounds and lock indicator lights.

To cancel the **CHILD LOCK**: Press and hold the **STOP/CLEAR** pad for 3 seconds until lock indicator on display turns off.

HOW TO SET THE OVEN CONTROLS

SENSOR COOK

Sharp's Sensor detects the vapor (moisture and humidity) emitted from the food as it heats. The sensor adjusts the cooking times and power level for various foods and quantities.

- Suppose you want to cook potatoes.

PROCEDURE

Press **BAKED POTATOES** pad.

**BAKED
POTATOES**

The oven starts immediately. When the sensor detects the vapor emitted from the food, remainder of cooking time will appear.

FOOD

Popcorn

Baked Potato

Reheat

Fresh Vegetables

Frozen Entress

Pizza

Ground Meat

Beverage

Fish/Seafood

COMPU DEFROST

The oven could be used to defrost food on the weight you entered. The defrosting time and power level are automatically set once the weight is programmed. The weight varies between 100g and 1800g.

- Suppose you want to defrost 600g shrimp.

PROCEDURE

1 Press **COMPU DEFROST** pad to select food weight.

**COMPU
DEFROST**

2 Press **START** pad.

START

NOTE: During defrosting process, the system will pause to remind user to turn food over, after that, press START to resume.

NOTE

1. During cooking process, you may touch the MORE or LESS pad to extend or shorten the cooking time (each touch for 10 seconds). The longest time you can set is 99:59.
2. If you open the oven door or press STOP/CLEAR during cooking, the system returns to standby mode immediately.
3. Do not use the sensor features twice in succession on the same food portion— it may result in severely overcooked or burnt food. If food is undercooked after the countdown, use time cooking for additional cooking time.
4. For Beverage, press BEVERAGE and then number pad 1 or 2 to select number of servings.



CLEANING AND CARE

1. Turn off the oven and remove the power plug from the wall socket before cleaning.
2. Keep the inside of the oven clean. When food splatters or spilled liquids adhere to oven walls, wipe them with a damp cloth. Mild detergent may be used if the oven gets very dirty. Avoid the use of spray and other harsh cleaners as they may stain, streak or dull the door surface.
3. The outside surfaces should be cleaned with a damp cloth. To prevent damage to the operating parts inside the oven, water should not be allowed to seep into the ventilation openings.
4. Wipe the door and window on both sides, as well as the door seals and adjacent parts frequently with a damp cloth to remove any spills or splatters. Do not use abrasive cleaner.
5. Do not allow the control panel to become wet. Clean with a soft, damp cloth. When cleaning the control panel, leave oven door open to prevent oven from accidentally turning on.
6. If steam accumulates inside or around the outside of the oven door, wipe with a soft cloth. This may occur when the microwave oven is operated under high humidity condition.
7. It is occasionally necessary to remove the glass tray for cleaning. Wash the tray in warm sudsy water or in a dishwasher.
8. The roller ring and oven floor should be cleaned regularly to avoid excessive noise. Simply wipe the bottom surface of the oven with mild detergent. The roller ring may be washed in mild sudsy water or dishwasher. When removing the roller ring from cavity floor for cleaning, be sure to replace in the proper position.
9. Remove odors from your oven by combining a cup of water with the juice and skin of one lemon in a deep microwaveable bowl, microwave for 5 minutes. Wipe thoroughly and dry with a soft cloth.
10. When it becomes necessary to replace the oven light, please consult a dealer to have it replaced.
11. The oven should be cleaned regularly and any food deposits removed. Failure to maintain the oven in a clean condition could lead to deterioration of the surface that could adversely affect the life of the appliance and possibly result in a hazardous situation.
12. Please do not dispose this appliance into the domestic rubbish bin, it should be disposed to the particular disposal center provided by the municipalities.

SPECIFICATIONS

	R-323T	R-423T
Power Consumption:	120V~60Hz, 1600W (Microwave)	120V~60Hz, 1600W (Microwave)
Output:	1100W	1100W
Operation Frequency:	2450MHz	2450MHz
Outside Dimensions (HxWxD):	11.8x21.3x15.8 in.	12.3x21.8x17.6 in.
Oven Cavity Dimensions (HxWxD):	8.7x13.9x14.1 in.	9.8x14.8x14.9 in.
Oven Capacity:	1.0 cu.ft	1.4 cu.ft
Cooking Uniformity:	Turntable System	Turntable System
Net Weight:	Approx. 35.3 lb.	Approx. 38.1 lb.

SHARP®

SHARP ELECTRONICS CORPORATION
Sharp Plaza, Mahwah, New Jersey 07495-1163