

Viking Use & Care Manual



Viking Range Corporation

111 Front Street

Greenwood, Mississippi 38930 USA

(662) 455-1200

For product information

call 1-888-VIKING1 (845-4641)

or visit the Viking Web site at

vikingrange.com



Built-In Full Height Wine Cellar

Congratulations

Your purchase of this product attests to the importance you place upon the quality and performance of the major appliances you use. With minimal care, as outlined in this guide, this product is designed to provide you with years of dependable service. Please take the few minutes necessary to learn the proper and efficient use and care of this quality product.

We appreciate your choosing a Viking Range Corporation product, and hope that you will again select our products for your other major appliance needs.

Table of Contents

Warnings	3
Important Safety Instructions	3
Proper Disposal of Your Old Refrigerated Product	4
Features of Your Wine Cellar	6
Before Using Your Wine Cellar	8
Electronic Control Center	9
Wine Storage System	11
Wine Storage Guidelines	17
Cleaning and Maintenance	19
Troubleshooting	20
Service Information	21
Warranty	22

Your safety is important to us. This use and care manual contains safety symbols and statements. Please pay special attention to these symbols and follow any instructions given.



This symbol alerts you to hazards such as fire, electrical shock or other injuries.

WARNING

To reduce the risk of fire, electric shock, or injury when using your wine cellar, follow these basic precautions:

- Read all instructions before using the wine cellar.
- Never allow children to operate, play with, or crawl inside the wine cellar.
- Never clean wine cellar parts with flammable fluids. The fumes can create a fire hazard or explosion.
- Always turn the power on/off switch (located behind the air grille on top right side) to the OFF position before attempting to change light tubes, clean, or service the wine cellar.

•FOR YOUR SAFETY•
DO NOT STORE OR USE GASOLINE OR OTHER FLAMMABLE VAPORS AND LIQUIDS IN THE VICINITY OF THIS OR ANY OTHER APPLIANCE. THE FUMES CAN CREATE A FIRE HAZARD OR EXPLOSION.

-SAVE THESE INSTRUCTIONS-

WARNING



ELECTRICAL SHOCK HAZARD

Plug into a grounded 3-prong outlet. If a 2-prong wall receptacle is encountered, contact a qualified electrician
Do not remove ground prong. Unit must be grounded at all times.
Do not use an adapter.
Do not use an extension cord.
Failure to follow these instructions can result in death, fire, or electrical shock.

Proper Disposal of Your Old Refrigerated Product

! DANGER

Risk of Child Entrapment

BEFORE YOU THROW AWAY ANY WINE CELLAR, REFRIGERATOR OR FREEZER:

- Take off the doors.
- Leave the shelves in place so that children may not easily climb inside.

IMPORTANT: Child entrapment and suffocation are not problems of the past. Junked or abandoned refrigerated products are still dangerous... even if they will sit for "just a few days."

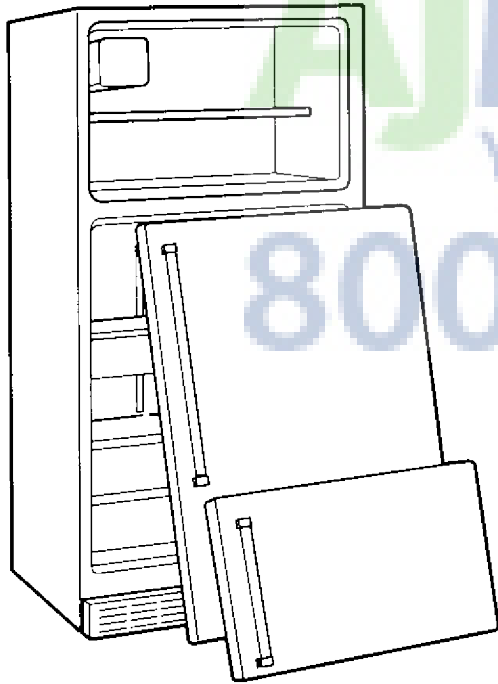

Safety/Installation Tips

- Install and level the wine cellar on a floor that will hold the weight and in an area suitable for its size and use.
- Do not install the wine cellar near an oven, radiator, or other heat source.
- Keep the wine cellar out of the weather.
- Connect the wine cellar only to the proper type of outlet, with the correct electrical supply and grounding. (Refer to the electrical requirements section of the Installation Instructions).
- Properly maintain the wine cellar.
- Be sure the wine cellar is not used by anyone unable to operate properly.

Madison
Your Appliance Authority™
800-570-3355

Features of Your Wine Cellar

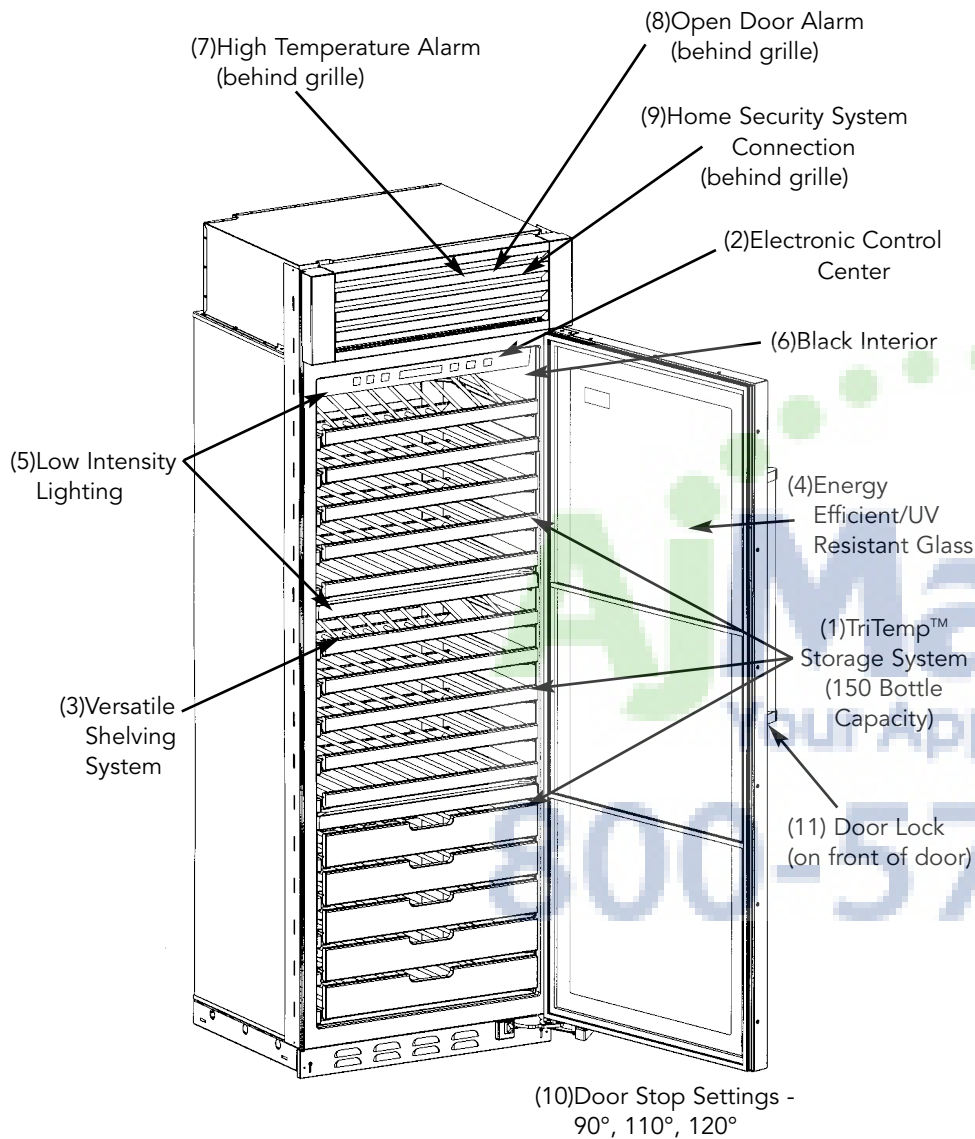

(1) TriTemp™ Storage System

Your wine cellar has three independent temperature zones separated by gaskets and tempered glass shelves to seal the zones. This allows you to set the temperatures in your wine cellar to match your wine storage needs. Each zone has its own fan, allowing for true air circulation within the zone. One control, conveniently located at the top of the unit, allows you to precisely control the temperature in each zone separately.

Bottom Zone - The bottom zone is designed for longer term wine storage with no lighting and raised wood facings to add further UV protection. This is the perfect place to store your most delicate and precious wine.

150 Bottle Capacity

Your wine cellar will accommodate 150 bottles of wine on the 15 shelves. Each shelf has a 10 bottle capacity.

(2) Electronic Control Center

The electronic control center allows you to set and monitor the operations of the wine cellar easily and accurately.

(3) Versatile Shelving System

Your wine cellar's shelving system is designed for optimal wine storage. This system includes two convertible display shelves that lay flat for normal storage or convert to display shelves to beautifully display your wine. All shelves are coated to absorb vibration and prevent unnecessary movement. Shelves pull forward on roller bearing glides and remain level at full extension allowing for easy loading and unloading and are fully removable for easy cleaning. Shelves are designed to accommodate different bottles sizes and shapes including standard bottle, half-size bottles and magnums.

(4) Energy Efficient & UV Resistant Glass Doors

Glass door units are energy efficient and UV resistant. The doors are insulated and coated to protect against UV rays.

(5) Low Intensity Lighting

The low intensity lighting system allows wines to be displayed without compromising wine integrity. Lights can be set so that they stay on for display purposes or to only come on when the door is opened.

(6)Black Interior

The wine cellar's black interior not only provides a stylish backdrop for your prized wines but absorbs harmful light and protects your wines.

(7)High Temperature Alarm

Your wine cellar has a high temperature alarm feature that will sound if temperatures within your wine cellar fluctuate outside of your set point by 5 degrees for an extended period of time.

(8)Door Alarm

The door alarm feature alerts you if you have left the wine cellar's door open for more than 3 minutes.

(9)Connection to Home Security System

For added peace of mind, your wine cellar can be connected to your home security system to alert you while away from home if the temperatures within your wine cellar fluctuate outside of your set point by 5 degrees for an extended period of time.

(10)Door Stop Settings

For utmost flexibility, the wine cellar door stop can easily be set to 90, 110, or 120 degrees, allowing it to be used in many different applications.

(11)Door Lock

A keyed door lock comes standard with the wine cellar. The door lock provides added protection for your wine collection.

Before Using Your Wine Cellar

To obtain the best possible results from your wine cellar, it is important that you operate it properly.

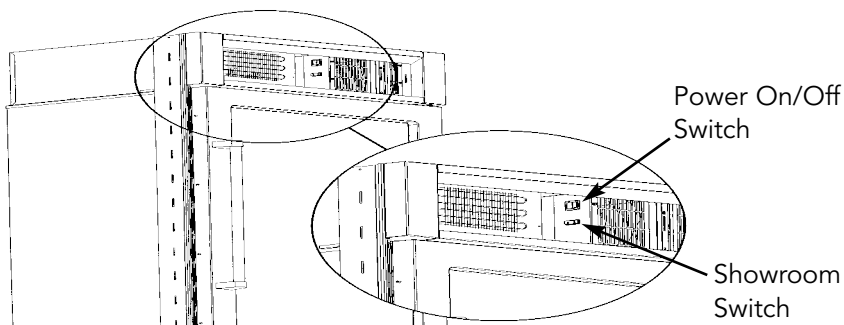

IMPORTANT

Be sure the power on/off switch is in the ON position after cleaning the wine cellar or changing the light tubes.

Power ON/OFF Switch

The power on/off switch is used to turn the power off to the wine cellar when cleaning it or changing the light tubes. The wine cellar is shipped with the power on/off switch in the on position. To turn the power off, remove the center grille assembly by grasping the three center louvers, lifting up and pulling outward. Press the power on/off switch to the "Off" position. To turn the power back on, press the power on/off switch to the "On" position. Replace the center grille assembly by aligning the hooks in the assembly with the slots in the brackets which are attached to the grille. Push in over the hooks and slide grille assembly downward.

Showroom Switch

The showroom switch allows electronic controls and interior lights to function independently of the refrigeration system. Your wine cellar is shipped with the showroom switch in the "Off" position. To use the showroom mode, remove center grille assembly and turn the showroom switch to the "On" position. Showroom mode will be engaged.

Electronic Control Center

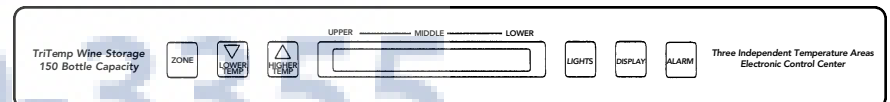

With the TriTemp™ Storage System, you can set the temperature in each of the three zones within a range of 43°F to 65°F (6°C to 18°C). The unit is factory set at 43°F (6°C) in the top two zones and 55°F (13°C) in the bottom zone. Select the zone you wish to adjust by pressing the "ZONE" key. The lighted bar on the control center will toggle between the upper, middle, and lower zones. When the bar above the zone you wish to adjust is lit, press the lower temp or higher temp key to select the desired temperature. The set temperature will flash on the control center. After 7 seconds, the temperature displayed will revert to the ACTUAL zone temperature and will no longer flash. To again view the set temperature, press the "ZONE" key. Refer to pages 17-18 for wine storage guidelines and suggested serving temperatures.

Lower Temp

The lower temp key allows you to decrease the temperature in the selected zone in one degree increments.

Higher Temp

The higher temp key allows you to increase the temperature in the selected zone by one degree increments.

Lights

The lights key allows you to turn the lighting on independent of the door opening for displaying the contents of the upper and middle zones. To turn the lights on, press the button once. Lights should not be left on for extended periods of time, as long term light exposure will affect the quality of your wine.

Display

The display key will turn the power to the display off. Press this button if you do not wish for the control panel to be illuminated. To turn the display on, press the display key.

Alarm

Your wine cellar is equipped with two alarms: High Temperature alarm and Open Door alarm. The High Temperature alarm will signal if the temperature in any zone fluctuates 5 degrees from your set point for an extended period of time. To set this alarm, press and hold the alarm key for two seconds. A bell will appear on the display when the alarm has been successfully enabled. When the alarm is triggered, a beeping noise will be heard and the wine cellar's display will flash and show an alarm message. To turn the alarm off, press the alarm key. To completely disengage the alarm, press and hold the alarm key for two seconds. The Open Door alarm is set automatically. The Open Door alarm will signal if the wine cellar's door has been left open for three minutes. A beeping noise will be heard and an alarm message will appear on the display. The wine cellar's door must be closed in order to turn the alarm off.

Temperature Unit Conversion

Your wine cellar is factory set to display degrees Fahrenheit. If you prefer Celsius, press and hold the alarm key and display key for 5 seconds.

Holiday Mode for Sabbath Observance

Pressing and holding the display button continuously for 10 seconds accesses this mode. The display will continue to be on as long as the button is pressed and at the end of 10 seconds, the display will turn off and holiday mode will be engaged. NOTE: To enter Holiday Mode, the display must be on prior to initiating the Holiday Mode. To cancel Holiday Mode, press and hold the display button continuously for 10 seconds. At the end of 10 seconds the display will turn on. When Holiday Mode is selected: a random time delay will be applied to the compressor relay start and stop. The chamber lights relay will remain de-energized. The display will not be illuminated. Audible sound (beep) from the control will be disabled. Fan outputs will not be affected by opening or closing of the door switch. All front panel buttons will be inoperative except a 10 second press of the display button causing the control to exit Holiday Mode. All other functions will continue as in normal cooling.

Wine Storage System

CAUTION

To store magnum or oversized bottles, the shelf directly above must be removed. Failure to do so could result in bottle breakage. See page 12 for proper shelf removal.

Versatile Shelving System

Your wine cellar's shelving system makes it easy to store standard, magnum and half-size bottles easily. There are a total of fifteen wine shelves which will each accommodate 10 bottles of wine, alternately displayed. Two convertible wine shelves adjust to allow bottles to be displayed.

Loading the Shelves

To load a shelf, pull the shelf forward and place the bottles on the shelf with the neck in the center of the shelf. Alternate the direction of the next bottle. Note the illustration to the right for maximum bottle storage.

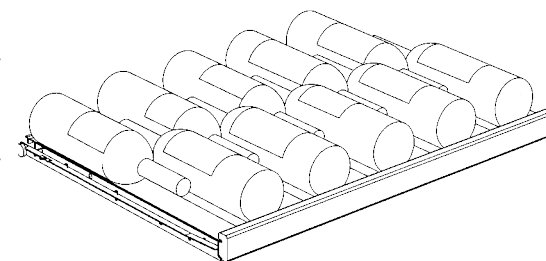

! CAUTION

Remove wine bottles from shelves before removing shelves. Failure to do so could result in bottle breakage.

Shelf Removal

To remove a wine shelf:

- 1) Pull the shelf forward until it is fully extended.

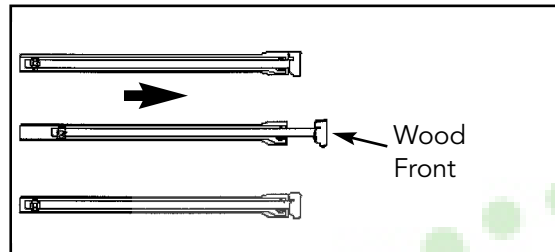

- 2) Lift up the front of the shelf.

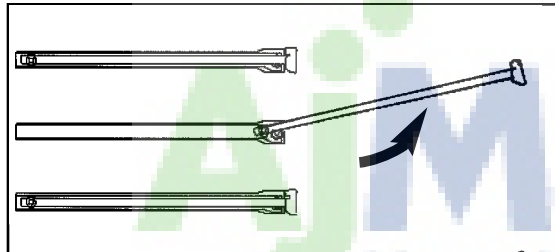

- 3) Remove from the glide.

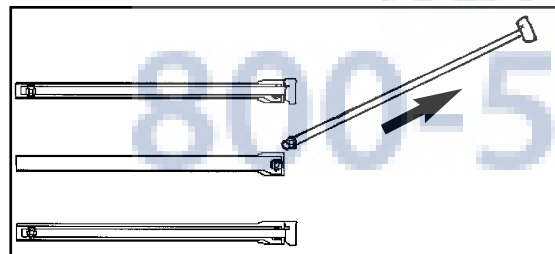

To replace the shelf, line shelf up with glide, lower into place and push shelf back.

Convertible Display Shelves

Your wine cellar has two convertible display shelves - one in each of the top two compartments. To use the display shelf, first remove any wine bottles stored on the shelf. Next, remove the wine shelf directly above (see shelf removal instructions on page 12). Lift the shelf up, rotate the shelf support up and lock shelf into place with legs (see illustration below).

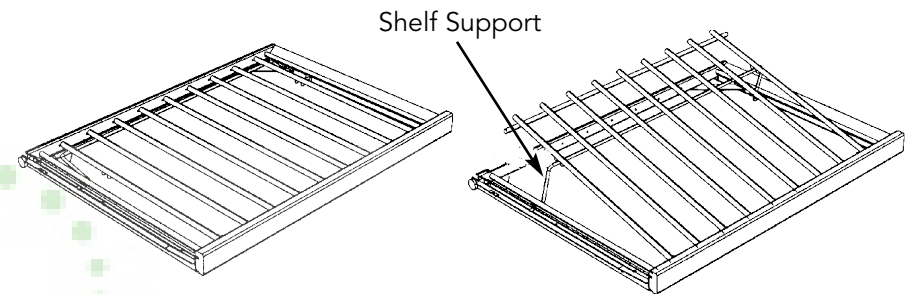

Wood Facings

Maple wood facings are included with each shelf. These facings may be left unfinished, finished and sealed, or replaced with other wood to match your cabinetry. Refer to the wine cellar installation instructions on how to replace the wood facings.

NOTE: Some finishes may cause undesirable odors. The recommended procedure is to test a sample in the wine cellar on scrap material before making permanent changes to wine cellar fronts.

Changing the Light Tube in the Top Zone

To change the light tube, first remove the center grille assembly and turn the power ON/OFF switch to the OFF position (see page 9).

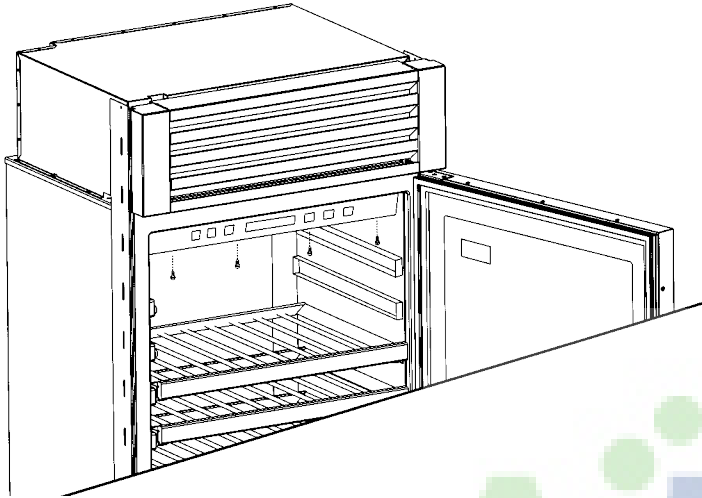

Control Panel

1. Remove the four screws from the lamp holder attaching the lamp holder to the underside of the control panel.
2. Rotate the rear of the lamp holder down and forward then pull the front tabs that engage into the control out of the control panel.
3. Set the lamp holder and screws to the side.
4. Pull the wires attached to the lamp tube through the hole in the control panel and disconnect the wires attaching the lamp to the cabinet wire harness.
5. The lamp tube is to be connected to one white wire and one yellow/red wire.
6. Place tubes in lamp holder. Feed wires back into control panel and reassemble in reverse order.

NOTE: Please contact your Viking Range Corporation parts distributor or dealer to order new light tubes.

Changing the Light Tube in the Middle Zone

To change the light tube, first remove the center grille assembly and turn the power ON/OFF switch to the OFF position (see page 9).

1. Remove the lamp wire cover by removing the two screws located on the upper left side of the middle zone. (NOTE: ONLY REMOVE THE TWO SCREWS HOLDING THE WIRE COVER; DO NOT REMOVE SHELF MOUNTING SCREWS).
2. Set the wire cover and screws to the side.
3. Disconnect the lamp by disconnecting one yellow and one white wire from each lamp.
4. Remove the clamp and screw located at the end of the lamp. The lamp is located on the underside of the middle mullion shelf.
5. Carefully unsnap light tube from shelf and snap new light tube into place.
6. Reassemble in reverse order.

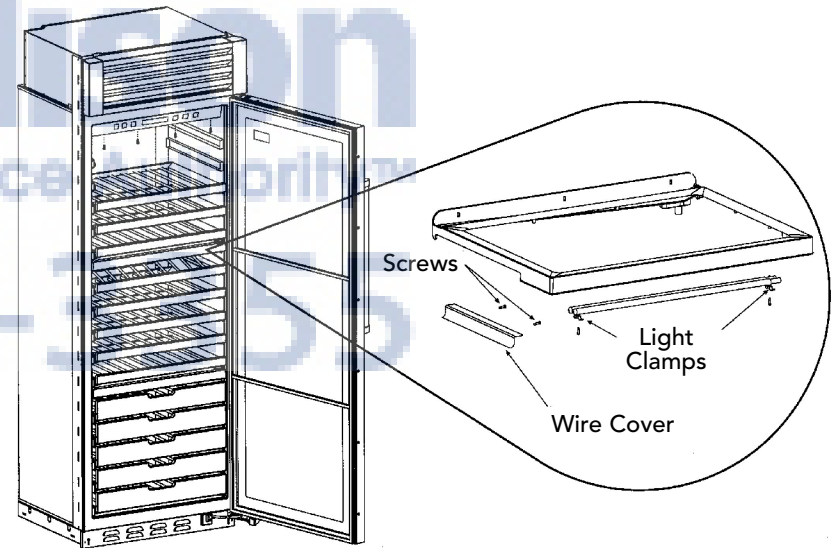

Home Security System Connection

The wine cellar may be connected to your home security system to protect your wine while away from home. Contact a qualified technician or your home security system representative and refer to the wine cellar installation instructions.

Door Stop Adjustment

Your wine cellar is factory set at 110° door stop position. To change to either the 90° or 120° position, remove door stop pin located in the bottom hinge using a 3/16" allen wrench. For 120° swing, move pin to utmost forward stop hole. For 90° swing, move pin to utmost rear stop hole.

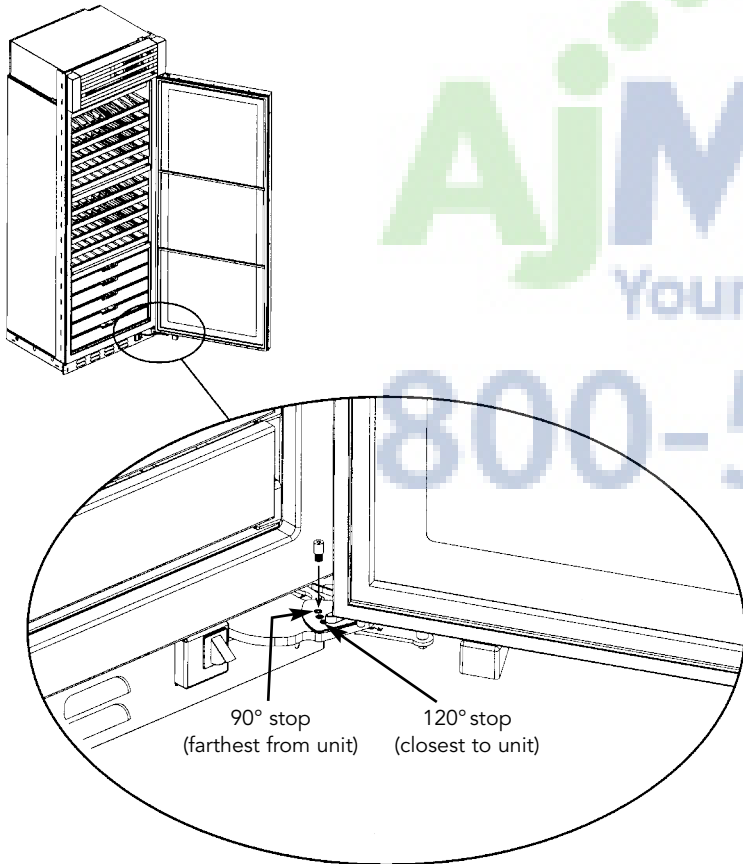

Wine Storage Guidelines

Wines that are stored for a long period of time should be stored at a stable temperature in a dark, vibration free environment. Wines stored for a short term (six months) can be stored at 55°F (13°C), or they can be stored at temperatures optimal for serving. The chart on the next page provides recommended serving temperatures for different types of wines.

- The ambient temperature of the room you locate your wine cellar in could affect the temperature in your wine cellar if the room temperature is lower than the wine cellar compartment setting. The wine cellar is designed to cool, not heat the stored wines. Temperatures inside the wine cellar cannot be higher than room temperatures outside of the wine cellar. The wine cellar is designed to perform at room temperatures of 70°F (21°C) and above.
- In certain conditions, the temperature of the middle zone can vary up to 5°F (2.8°C) from your selected temperature setting.

Optimal Wine Serving Temperatures

Red wines are generally served from cool to room temperatures (55°F - 65°F [13°C - 18°C]). White wines are served at cellar temperatures (50°F - 55°F [10°C - 13°C]), and sparkling wines are served at the coolest temperatures (45°F - 50°F [7°C - 10°C]).

Recommended Wine Serving Temperatures

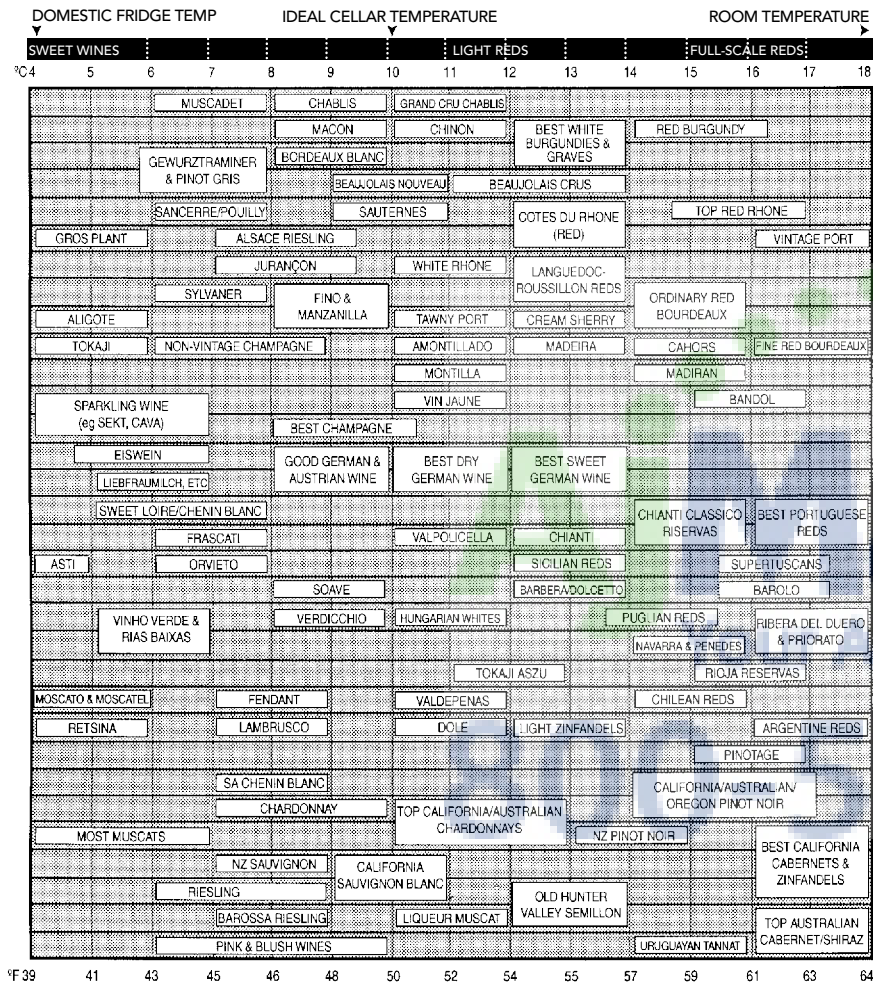

©Octopus Publishing Group. From *The World Atlas of Wine* by Hugh Johnson and Jancis Robinson, published by Mitchell Beazley.

Cleaning and Maintenance

Exterior

Stainless Steel - Clean with a non-abrasive stainless steel cleaner and soft cloth.

Painted Doors - Clean with mild detergent, warm water and sponge or soft cloth. Hand wash, wipe and dry thoroughly.

Glass - Clean with glass cleaner and a soft cloth or paper towel.

Interior

Interior (liner and shelves) - Clean with a baking soda or mild detergent and water solution and a sponge or soft cloth. Wipe and dry thoroughly. Take care not to get water on the lights, control panel or wood facings of the shelves. **DO NOT USE ABRASIVE CLEANERS.**

Gaskets - Clean with a mild detergent and water solution and a sponge, soft cloth or paper towel. Wash, wipe, and dry thoroughly. Apply a thin coat of petroleum jelly to keep gasket pliable. Do not use waxes, concentrated detergents, or cleaners containing chlorine bleach.

Electronic Control Center - Clean with mild detergent, warm water, and a sponge or soft cloth.

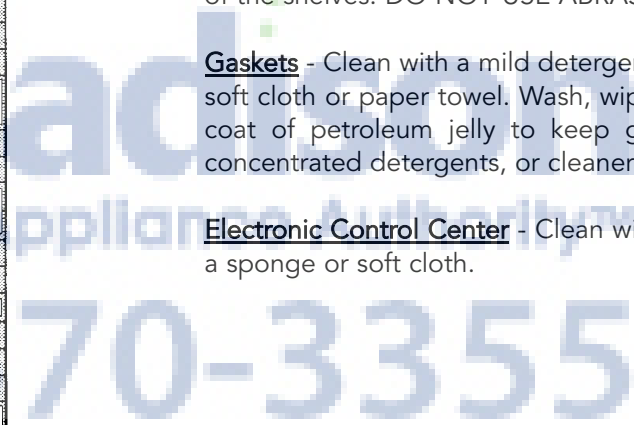

Troubleshooting

Performance problems often result from little things that can be fixed without tools. Listed in the chart below are some of the most common problems consumers run into with their wine cellar. Please read through the troubleshooting chart and "Service Information" on the next page before calling for service on your wine cellar.

Problem

Wine cellar will not operate - Is the power cord plugged into a live circuit with the proper voltage? Has a household fuse blown or circuit breaker tripped? Is the power switch in the ON position?

Water in the defrost pan - This is normal in hot, muggy weather. Make sure the pan is level so it does not overflow.

Lights do not work - Has a household fuse blown or circuit breaker tripped? Is a light burned out?

Wine Cellar seems to run too long - The motor will run longer on hot days, if the room is too warm, several warm wine bottles are added at the same time, or if the door is opened too often.

Wine Cellar too warm - Is the electronic control center set properly? Has the door been left open for a long period of time?

Service Information

If service is required after checking the troubleshooting guide:

1. Call your dealer or authorized service agency. The name of the authorized service agency can be obtained from the dealer or distributor in your area.
2. Have the following information readily available: Model Number, Serial Number, Date of Purchase, and Name of dealer from whom purchased
3. Clearly describe the problem that you are having.

If you are unable to obtain the name of an authorized service agency, or if you continue to have service problems, contact Viking Range Corporation at (888) 845-4641 or write to:

VIKING PREFERRED SERVICE
111 FRONT STREET
GREENWOOD, MS 38930 USA

Record the following information indicated below. You will need it if service is ever required. The serial number and model number of your wine cellar is located on the left wall in the bottom zone.

Model Number _____ Serial Number _____

Date of Purchase _____ Date Installed _____

Dealer's Name _____

Address _____

If service requires installation of parts, use only authorized parts to ensure protection under the warranty.

Please retain this manual for future reference.

BUILT-IN WINE CELLAR WARRANTY

TWO YEAR FULL WARRANTY

Built-in full height wine cellars and all of their components and accessories, except as detailed below, are warranted to be free from defects in material or workmanship under normal household use for a period of two (2) years from the date of original retail purchase. Viking Range Corporation, warrantor, agrees to repair or replace, at its option, any part which fails or is found to be defective during the warranty period.

*Painted and decorative items are warranted to be free from defective materials or workmanship for a period of ninety (90) days from the date of original retail purchase. ANY DEFECTS MUST BE REPORTED TO THE SELLING DEALER WITHIN NINETY (90) DAYS FROM DATE OF ORIGINAL RETAIL PURCHASE.

SIX YEAR FULL WARRANTY

Any sealed refrigeration system component, as listed below, is warranted to be free from defective materials or workmanship in normal household use during the third through the sixth year from the date of original retail purchase. Viking Range Corporation, warrantor, agrees to repair or replace, at its option, any part which fails or is found to be defective during the warranty period.

Sealed Refrigeration System Components:

Compressor, Evaporator, Condenser
Connecting Tubing, Dryer/Strainer, solenoid valves

TWELVE YEAR LIMITED WARRANTY

Any sealed refrigeration system component, as listed above, which fails due to defective materials or workmanship in normal household use during the seventh through the twelfth year from the date of original retail purchase will be repaired or replaced, free of charge for the part itself, with the owner paying all other costs, including labor.

NINETY (90) DAY RESIDENTIAL PLUS WARRANTY This warranty applies to applications where use of the product extends beyond normal residential use. Examples are, but not limited to, bed and breakfasts, fire stations, private clubs, churches, etc. This warranty excludes all commercial locations such as restaurants, food service locations and institutional food service locations.

This warranty extends to the original purchaser of the product warranted hereunder and to each transferee owner of the product during the term of the warranty.

This warranty shall apply to products purchased and located in the United States and Canada. Products must be purchased in the country where service is requested. Warranty labor shall be performed by an authorized Viking Range Corporation service agency or representative. Warranty shall not apply to damage resulting from abuse, accident, natural disaster, loss of electrical power to the product for any reason, alteration, improper installation, improper operation or repair or service to the product by anyone other than an authorized Viking Range Corporation service agency or representative. Warranty shall not apply to damage resulting from indoor units being used in outdoor situations. This warranty does not apply to commercial usage. Warrantor is not responsible for consequential or incidental damage whether arising out of breach of warranty, breach of contract, or otherwise. Some jurisdictions do not allow the exclusion or limitation of incidental or consequential damages, so the above limitation or exclusion may not apply to you.

Owner shall be responsible for proper installation, providing normal care and maintenance, providing proof of purchase upon request, and making the appliance reasonably accessible for service. If the product or one of its component parts contains a defect or malfunction during the warranty period, after a reasonable number of attempts by the warrantor to remedy the defects or malfunctions, the owner is entitled to either a refund or replacement of the product or its component part or parts. Replacement of a component part includes its free installation. Warrantor's liability on any claim of any kind, with respect to the goods or services covered hereunder, shall in no case exceed the price of the goods or service or part thereof of which gives rise to the claim.

WARRANTY SERVICE: Under the terms of this warranty, service must be performed by a factory authorized Viking Range Corporation service agent or representative. Service will be provided during normal business hours, and labor performed at overtime or premium rates shall not be covered by this warranty. To obtain warranty service, contact the dealer from whom the product was purchased, an authorized Viking Range Corporation service agent, or Viking Range Corporation. Provide model and serial number and date of original purchase. For the name of your nearest authorized Viking Range Corporation service agency, call the dealer from whom the product was purchased or Viking Range Corporation. **IMPORTANT:** Retain proof of original purchase to establish warranty period.

The return of the Owner Registration Card is not a condition of warranty coverage. You, however, should return the Owner Registration Card so that Viking Range Corporation can contact you should any question of safety arise which could affect you.

Any implied warranties of merchantability and fitness applicable to the above described built-in full height wine cellar are limited in duration to the period of coverage of the applicable express written limited warranties set forth above. Some jurisdictions do not allow limitations on how long an implied warranty lasts, so the above limitation may not apply to you. This warranty gives you specific rights, and you may also have other rights which may vary from jurisdiction to jurisdiction.

Specifications subject to change without notice.