

DUAL FUEL SELF-CLEAN RANGE

RVDR3301-5B – 30" WIDE



Features and Functions

- Wide variety of BTU ratings to accommodate all types of surface cooking needs – including a fifth burner
 - Left front – 18,000 BTU
 - Left rear – 8,000 BTU
 - Center – 9,000 BTU
 - Right front – 18,000 BTU
 - Right rear – 12,000 BTU
- Sealed burners with porcelainized, cast-iron burner caps
- **Exclusive** – SureSpark™ Ignition System
 - Automatic electric spark ignition/re-ignition; surface burners light at any position on the knob and re-light if extinguished even on lowest setting
- **Exclusive** – largest oven cavity in the industry
 - 4.7 cu. ft. overall
 - 4.1 cu. ft. measured to AHAM standard
(See specifications chart for oven interior dimensions)
- High performance cooking modes include Bake, Convection Bake, TruConvec™ Convection Cooking, Convection Roast, Hi Broil, Medium Broil, Low Broil, Convection Broil, Convection Dehydrate, and Convection Defrost
- **Exclusive** – Patented Vari-Speed Dual Flow™ Convection System has the largest convection fan in the industry; the 8 1/2" fan works bi-directionally for maximum airflow and excellent cooking results



30" Wide Dual Fuel Self-Clean Range
(Shown with optional 6" H. backguard)

- Concealed 10-pass dual bake element provides precise temperature control
- 10-pass broiler with heat reflector provides superior broiling performance
- Rapid Ready™ Preheat provides super fast preheating
- Oven has six porcelain-coated rack supports and comes standard with one TruGlide™ full extension oven rack and two standard racks
- Halogen oven lighting provides excellent visibility throughout oven cavity
- Shipped standard with island trim
- Accessory portable griddle/grill (RDPGD) available for use over center burner

Easy Operation and Cleanup

- Extremely large self-clean convection oven
- Permanently sealed burners – spills cannot enter the one-piece tooled and porcelainized burner box
- Durable metal die-cast knobs with child-proof, push-to-turn safety feature
- Customer removable knobs, grates, and burners/caps for easy cleaning
- Continuous grate design for easy movement of pots and pans

Installation Accessories

- 6" high backguard (RD301BG6SS)
- Countertop side trim (RD24CSTSS)
- Countertop rear trim (P30CRTSS)
- Curb base and custom curb base front (P30CBF4SS)
- LP conversion kit (RDLPKR)

Finishes

- Available in Stainless Steel (SS), Black (BK), and White (WH)



Warranty Highlights

- One-year full – complete product
- Ninety-day full – cosmetic parts such as glass, painted items, and decorative items
- Five-year limited – surface/tube burners

DUAL FUEL SELF-CLEAN RANGE

RVDR3301-5B – 30" WIDE



DESCRIPTION	DUAL FUEL SELF-CLEAN 30" WIDE RANGE
	RVDR3301-5B
Overall Width	29-7/8" (75.9 cm)
Overall Height	To top of side trim – 35-7/8" (91.1 cm) minimum; 37" (94.0 cm) maximum Legs adjust – 1-1/8" (2.9 cm)
Overall Depth from Rear	To front of side panel – 25" (63.5 cm) To front of door – 25-3/4" (65.4 cm) To front of control panel – 27-1/8" (68.9 cm) To end of knobs – 29" (73.7 cm)
Additions to Overall Height	To top of island trim – add 0" (0.0 cm) To top of 6" h. backguard – add 6" (15.2 cm) To top of high shelf – add 18-3/16" (46.2 cm)
Gas Requirements	Ships Natural or LP/Propane; Field convert with conversion kit (purchased separately); accepts standard residential 1/2" (1.3 cm) ID gas service line.
Gas Manifold Pressure	Natural 5.0" W.C.P./ Liquid Propane L/P 10.0" W.C.P.
Electrical Requirements	240-208 VAC 60 Hz electrical connection box on product, connect with locally supplied 3-wire, flexible cord or "pigtail" rated 40 amp. 125-250 VAC minimum. Cord must be agency approved for use with household electric ranges.
Maximum Amp Usage	240V – 25.4 amps; 208V – 22.9 amps
Surface Burner Rating Natural/LP	Left Front: 18,000 BTU Nat./15,800 BTU LP/Propane (5.3 kW Nat./4.7 kW LP/Propane) Left Rear: 8,000 BTU Nat./7,200 BTU LP/Propane (2.3 kW Nat./1.9 kW LP/Propane) Center: 9,000 BTU Nat./8,000 BTU LP/Propane (2.7 kW Nat./2.3 kW LP/Propane) Right Front: 18,000 BTU Nat./15,000 BTU LP/Propane (5.3 kW Nat./4.7 kW LP/Propane) Right Rear: 12,000 BTU Nat./10,800 BTU LP/Propane 3.5 kW Nat./3.2 kW LP/Propane)
Oven Interior Width	25-5/16" (64.6 cm)
Oven Interior Height	16-1/2" (41.9 cm)
Oven Interior Depth	Overall – 19-1/2" (49.5 cm) AHAM* – 16-13/16" (42.7 cm)
Oven Volume	Overall – 4.7 cu. ft. AHAM* – 4.1 cu. ft.
Approximate Shipping Weight	410 lb. (184.5 kg)

*The AHAM standard for measuring oven capacity subtracts the doorplug and convection baffle dimension from the total oven volume. Please do not prepare installation from brochure data only. See installation instructions for important clearance/installation information.

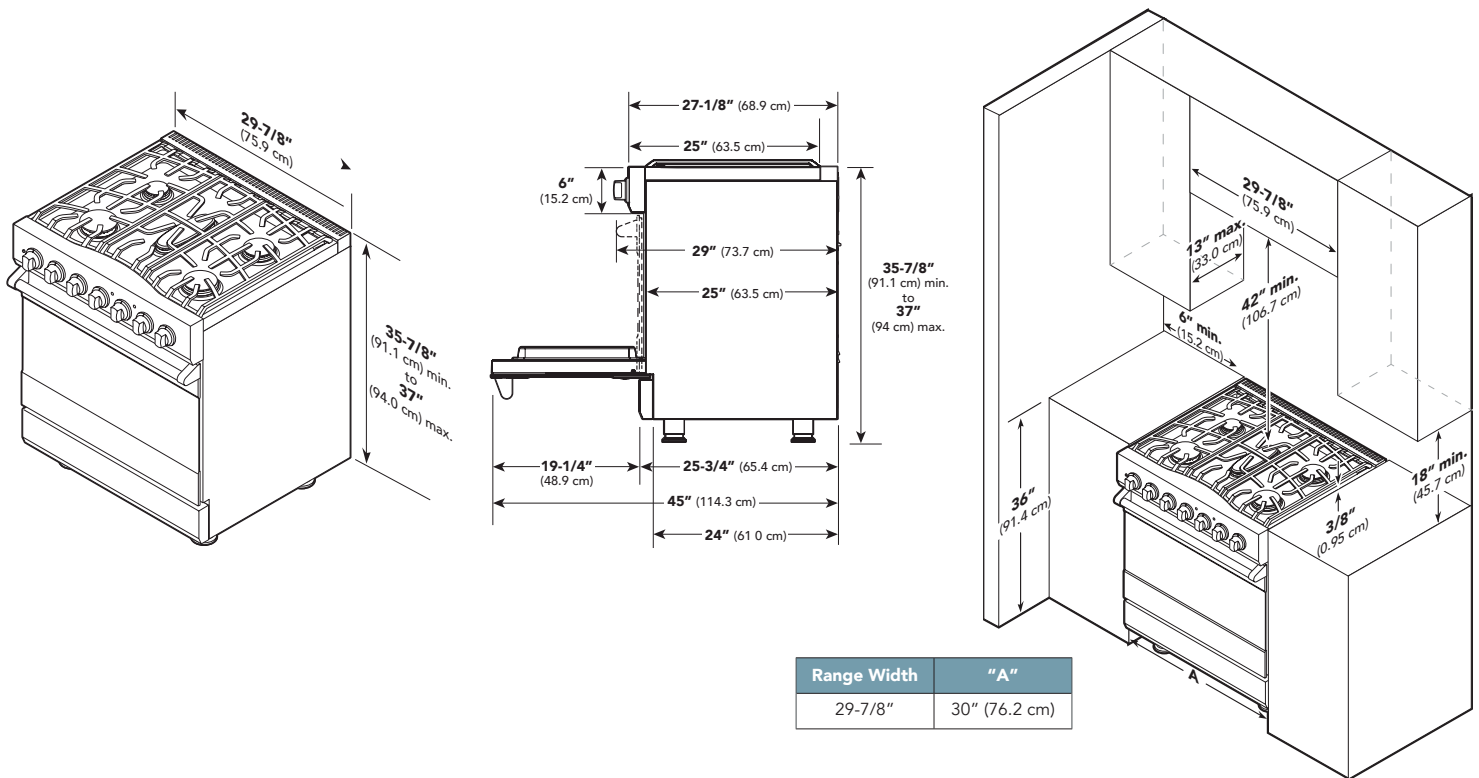

VIKING RANGE, LLC 111 FRONT STREET GREENWOOD, MISSISSIPPI 38930 USA

For detailed product information, model numbers, or to request a quote call 1-888-845-4641 or visit vikingrange.com
© 2013 Viking Range, LLC I Specifications subject to change without notice.