

Lighting Grill

Before Lighting Grill

Prior to turning on the gas, inspect the gas supply tubing or hose. Look for evidence of abrasion, cuts, wear and tear, or other damage which could require replacement prior to use. Make sure all burner control knobs are off. **DO NOT** attempt to light the burners if the smell of gas is present.

Check the connection with a soap and water solution after attaching the hose. Make sure there is gas in the tank and the tank is upright.

CAUTION

Wait at least five minutes before relighting a hot grill to allow any accumulated gas to dissipate. Keep a spray bottle of soapy water near the gas supply valve and check the connections for gas leaks before each use.

Battery Ignition Models

When lighting a burner, **ALWAYS** pay close attention to what you are doing. Be certain you are pressing the battery ignition button corresponding to the burner you are lighting.

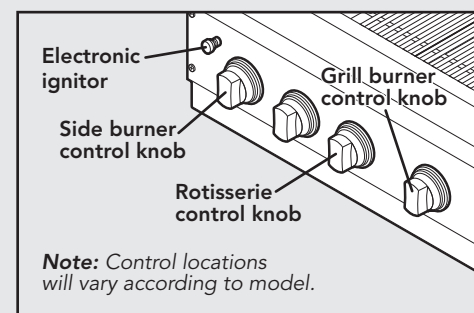

Lighting Grill Burners

Open the hood or remove covers. Push and turn the control knob until the "HIGH" position on the knob aligns with the indicator line on the control panel. **Press the electronic ignition button corresponding to the burner being lit.** You will hear a clicking sound. Turn the control knob to the desired setting. **If the burner does not light in 4 seconds, turn the knob to "OFF" and wait 5 minutes before trying again.**

This will allow accumulated gas to dissipate. After several failed attempts, the burner can be lit with a paper book match using the flash tubes.

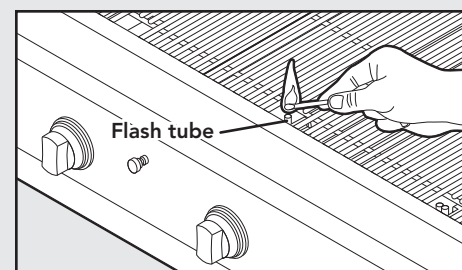

Lighting Grill Burners with Flash Tubes

If you have just attempted to light the burner with the igniter, allow 5 minutes for any accumulated gas to dissipate. Place the lit match through the grid next to the flash tube of the burner being lit. Keep your face as far away from the grill as possible. Make sure the match is adjacent to the flash tube. Push and turn the control knob until the "HIGH" position on the knob aligns with the indicator line on the control panel. Make sure you are turning the control knob that corresponds with the burner being lit. If the burner does not light in 4 seconds, turn the knob to "OFF," wait 5 minutes, and try again. If the burner will not light after several attempts, see the *Troubleshooting* section.

Lighting TruSear™ Infrared Burner (If Applicable)

Before lighting the burner, remove the stainless steel cover. Push in and turn the TruSear™ infrared control knob until the "HIGH" position on the knob aligns with the indicator line on the control panel. You will hear a clicking sound. Once lit, turn the control knob to the desired setting. **If the burner does not light within 4 seconds, release and turn the control knob to "OFF." Wait 5 minutes for any accumulated gas to dissipate and try again.** After several failed attempts, the burner may be lit by turning the control knob to "HIGH" and dropping a match on the face of the burner. If the burner does not immediately ignite, turn the knob to "OFF", wait 5 minutes and try again.

Lighting Grill (cont.)

Lighting Side Burners

First, remove the burner cover or any cooking utensil from the burner grate.

CAUTION

The side burner cover may be hot if the grill burners are in operation.

Push and turn the control knob until the "HIGH" position aligns with the indicator line on the control panel. **Immediately press the electronic ignition button corresponding to the burner(s) being lit until the burner is lit or until 4 seconds pass. If the burner does not light after several attempts, wait five minutes to allow any accumulated gas to dissipate.** If the burner will not light after several attempts, then the burner can be lit by holding a lit match next to the burner ports. Push and turn the control knob until the "HIGH" position on the knob aligns with the indicator line on the control panel.

Lighting the Grill Burners (300 and 500 Series Models)

Make sure the unit is plugged into a properly grounded receptacle. Turn the appropriate control knob counter-clockwise to any position. This control is both a gas valve and an electric switch. Burners will ignite at any "ON" position with the automatic recognition system. If the flame goes out for any reason, the burners will automatically reignite if the gas is still flowing. When gas is permitted to flow to the burners, the electric igniters start sparking. On all surface igniters, you should hear a clicking sound. If you do not, turn off the control and check that the unit is plugged in and that the fuse or circuit breaker is not blown or tripped.

Within a few moments, enough gas will have traveled to the burner to be able to light. When the burner lights, turn the burner control to any position to adjust the flame size. **If the burner does not light in 4 seconds, turn the knob to "OFF" and wait 5 minutes before trying again.** This will allow accumulated gas to dissipate. After several failed attempts the burner can be lit with a paper book match using the flash tubes.

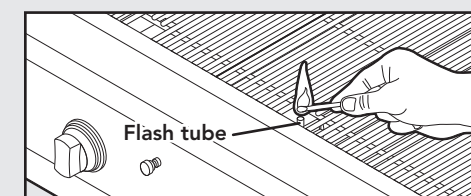

Lighting Grill Burners with Flash Tubes

If you have just attempted to light the burner with the igniter, allow 5 minutes for any accumulated gas to dissipate. Place the lit match through the grid next to the flash tube of the burner being lit. Keep your face as far away from the grill as possible. Make sure the match is adjacent to the flash tube. Push and turn the control knob until the "HIGH" position on the knob aligns with the indicator line on the control panel. Make sure you are turning the control knob that corresponds with the burner being lit. **If the burner does not light in 4 seconds, turn the knob to "OFF," wait 5 minutes, and try again.** If the burner will not light after several attempts, see the *Troubleshooting* section.

Lighting Infrared Rotisserie Burner (On Applicable Models)

The location of the infrared burner makes it more susceptible to strong wind conditions—more so than the protected grill burners. For this reason you should avoid using it during windy conditions.

Open the canopy. Push in and turn the rotisserie control knob until the "HIGH" position on the knob aligns with the indicator line on the control panel and continue to hold in the knob. Press the electronic ignition button which corresponds to the rotisserie control knob. You will hear a clicking sound. After the burner lights, hold the rotisserie control knob in about 5 seconds longer or until the burner remains lit. Once lit, turn the control knob to the desired setting. If the burner does not light within 4 seconds, release and turn the control knob to "OFF". **Wait 5 minutes for any accumulated gas to dissipate.** If the burner does not light after several attempts, then the burner can be lit by holding a lit match to the burner (with the control knob pushed in at the light position). Push and turn the control knob until the "HIGH" position on the knob aligns with the indicator line on the control panel. Make sure you are turning the control knob that corresponds with the burner being lit. If relighting a hot burner, wait 5 minutes. **NEVER leave the rotisserie control knob at "ON" if rotisserie is not in use.**

Features

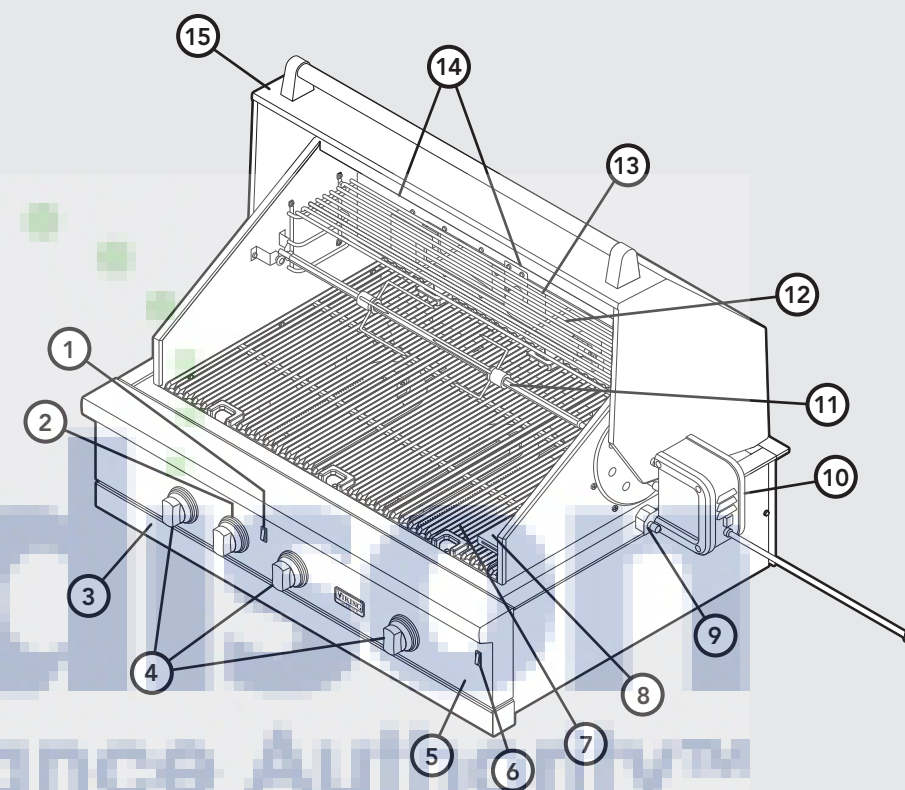

Note: Control locations will vary according to model.

1. Electronic ignition
2. Rotisserie control knob
3. Pull out drip tray
4. Grill burner control knobs
5. 9V battery—behind control panel (100 Series models)
6. Interior light switch (300 and 500 Series)
7. Porcelain grids w/ceramic briquette trays underneath
8. Smoker box
9. Rotisserie bracket
10. Rotisserie motor
11. Spit rod w/forks
12. Warming rack (if applicable)
13. Infrared rotisserie burner
14. Interior lights (300 and 500 Series)
15. Canopy

Using Grill

Before You Begin

- Before each use, turn the control knob to "HIGH" and preheat for 5-7 minutes.
- Check to be certain the drip tray is in place.
- Light the grill burners using the lighting instructions.
- Place the food on the grill and cook to the desired doneness. Adjust heat setting, if necessary. The control knob may be set to any position between "HIGH" and "LOW."
- Allow grill to cool before cleaning. (Drip tray should be cleaned after each use.)

Canopy Thermometers (If Applicable)

Your outdoor grill is equipped with a thermometer on the canopy. The thermometer is designed to aide in the preheating of the grill and closed canopy grilling. The estimated cooking temperatures with the canopy closed are:

WARM 150°F (65°C)
COLD SMOKE 150°F – 200°F (65°C – 93°C)
SMOKE 200°F – 300°F (93°C – 149°C)
GRILL 300°F – 750°F (149°C – 399°C)

Canopy thermometer

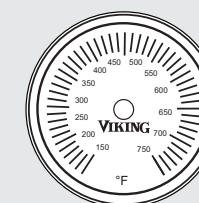

Smoker Box

Using the smoker box feature intensifies the flavor by adding smoke to the grilling process. The additional smoke creates a "cloud" around the food which permeates meats and vegetables for added smoky flavor. In order to use the smoker box, remove the last set of porcelain grids on the right hand side of the grill. Set the smoker box in the opening so that the front and rear tabs rest on the grill frame.

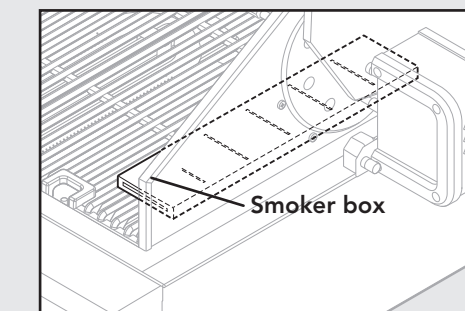

Wood Chip Use in Smoker Box

There are many wood chips available and selection is based on personal taste. The most common chips used are mesquite or hickory. **ALWAYS** soak the chips in water prior to putting them into the box. Use the "HIGH" position to start the chips smoking, then reduce the heat to a lower level to prevent them from drying out and flaming. If the wood chips do flame up, add a small amount of water to extinguish the flame. Use caution when adding water to a hot box to avoid steam burns. This tray may also be filled with water to produce steam. Whether smoking or steaming, the grill should remain closed as much as possible to maximize the effect.

During extended roasting periods, it is normal to add fresh wood chips and water to the box several times. Limit the amount of times the canopy is opened—each peek adds about 15 minutes to the cooking time.

CAUTION

Handle the smoker box with care. The cover becomes extremely hot when being used. Use sturdy, properly insulated gloves or dry potholders.

Rotisserie

The rotisserie burner is an infrared burner which provides intense searing radiant heat. Preferred by professional chefs over other methods, this intense heat is great for searing in the natural juices and nutrients found in quality cuts of meat. Once lit, the rotisserie burner will reach cooking temperatures in about 1 minute. The red glow will even out in about 5 minutes.

To install the rotisserie motor, align the drive shaft on the motor with the gear box on the side of the grill. Tighten the thumb screws on the motor into the mounting brackets on the grill frame. The skewer for the rotisserie is assembled into the gear box assembly by placing the pointed end into the gear box and resting the rounded end on the wheels on the left side of the grill.

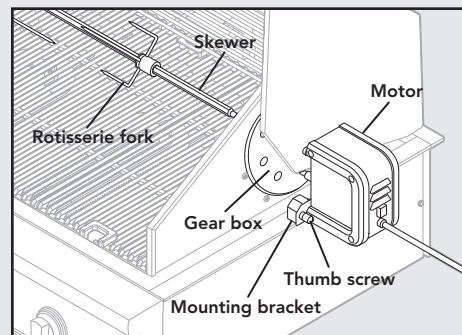

⚠ WARNING
ELECTRICAL SHOCK HAZARD
 This unit is equipped with a grounding plug for your protection against shock hazard and should be plugged directly into a properly grounded receptacle. **DO NOT** cut or remove the grounding prong from this plug. **Keep the rotisserie motor electric cord away from the heated surfaces of the grill.**

To load the skewer, slide one of the rotisserie forks (prongs facing away from the end) onto the skewer. Push the skewer through the center of the food, then slide the second rotisserie fork (prongs toward the food) onto the skewer. Center the product to be cooked on the skewer then push the forks firmly toward the food. Tighten the wing nuts with pliers. It may also be necessary to wrap the food with butcher's string to secure loose portions. **NEVER** use nylon or plastic string. Once the food is secure, insert the skewer into the motor. To turn on rotisserie motor, flip the ON/OFF switch located on the rotisserie motor assembly.

If needed, remove the grill grates. Place the basting pan beneath the food. Keep canopy closed while using the rotisserie. Each peek adds about 15 minutes to the cooking time. A meat thermometer should be used when cooking large pieces of meat to ensure that the meats are rare, medium, or well cooked.

Warnings

Warning and Important Safety Instructions appearing in this guide are not meant to cover all possible conditions and situations that may occur. Common sense, caution, and care must be exercised when installing, maintaining, or operating the appliance.

ALWAYS contact the manufacturer about problems or conditions you do not understand.

Recognize Safety Symbols, Words, Labels

⚠ DANGER
 Hazards or unsafe practices which **WILL** result in severe personal injury or death

⚠ WARNING
 Hazards or unsafe practices which **COULD** result in death, severe personal injury or property damage

⚠ CAUTION
 Hazards or unsafe practices which **COULD** result in minor personal injury.
 All safety messages will identify the hazard, tell you how to reduce the chance of injury, and tell you what can happen if the instructions are not followed.

Read and follow all instructions before using this appliance to prevent the potential risk of fire, electric shock, personal injury or damage to the appliance as a result of improper usage of the appliance. Use appliance only for its intended purpose as described in this guide.

⚠ WARNING
 To reduce the risk of fire, electric shock, or injury, read and follow these basic precautions before operating your gas grill or side burners.

⚠ WARNING
EXPLOSION HAZARD
DO NOT use the grill as storage area for flammable materials. Keep area clear and free from combustible materials, gasoline, and other flammable vapors and liquids. Failure to do so can result in death, explosion, or fire.

⚠ WARNING
 Before lighting the burners, inspect the gas supply piping or hose. If there is evidence of cuts, wear, or abrasion, it must be replaced prior to use. **ALWAYS** keep your face and body as far away from the grill as possible when lighting.

⚠ WARNING
ELECTRICAL SHOCK HAZARD
 This unit is equipped with a grounding plug for your protection against shock hazard and should be plugged directly into a properly grounded receptacle. **DO NOT** cut or remove the grounding prong from this plug. **Keep the rotisserie motor electric cord away from the heated surfaces of the grill.**

⚠ WARNING
DO NOT use flammable cleaning materials. Use a flashlight to inspect the burner inlet to ensure it is not blocked. If obstructions can be seen, use a metal wire coat hanger that has been straightened out. Shake out any debris through the air shutter.

⚠ WARNING
SPIDER AND INSECT INFESTATION
 Spiders and insects can nest in the burners/venturi tubes of this or any other grill, and cause the gas to flow from the front of the burner. This is a very dangerous condition that can cause a fire to occur behind the valve panel, thereby damaging the grill and making it unsafe to operate.

⚠ WARNING
 This unit is for outdoor use only! **DO NOT** operate in enclosed areas. This could result in carbon monoxide buildup which could result in injury or death.

⚠ CAUTION
 The side burner cover may be hot if the grill burners are in operation.

Warnings (cont.)

⚠ CAUTION
 Wait at least five minutes before relighting a hot grill to allow any accumulated gas to dissipate. Keep a spray bottle of soapy water near the gas supply valve and check the connections for gas leaks before each use.

⚠ CAUTION

- DO NOT** use a metal knife or any other metal tool to scrape stainless steel parts.
- DO NOT** permit citrus or tomato juice to remain on stainless steel surfaces, as citric acid will permanently discolor stainless steel. Wipe up any spills immediately.
- DO NOT** use abrasive cleaners, steel wool pads, or abrasive cloths on stainless steel, painted parts, or brass parts.
- DO NOT** use brass cleaners on the brass option parts. They feature an epoxy coating.

⚠ CAUTION
 Handle the smoker box with care. The cover becomes extremely hot when being used. Use sturdy, properly insulated gloves or dry potholders.

⚠ FOR YOUR SAFETY
 If you smell gas
 1. Shut off gas to the appliance.
 2. Extinguish any open flames.
 3. Open lid.
 4. If odor continues, immediately call your gas supplier.

⚠ FOR YOUR SAFETY
 1. **DO NOT** store or use gasoline or other flammable vapors and liquids in the vicinity of this or any other appliance.
 2. **DO NOT** store any propane/butane (G31-G30) cylinder (that is not connected for use) in the vicinity of this or any other appliance.

Viking Quick Reference Guide

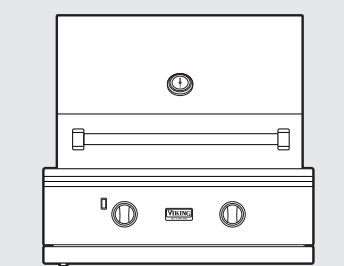
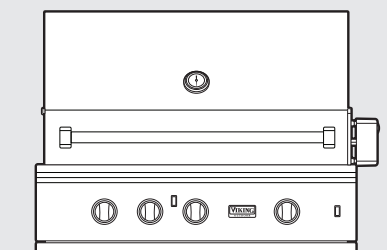
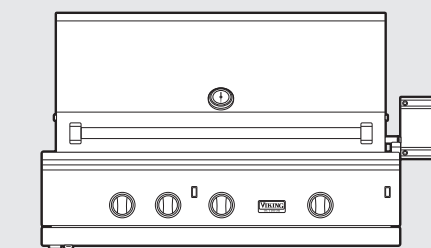
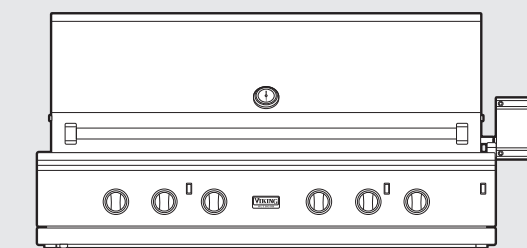

Outdoor Gas Grills

