

Viking Installation Guide



Viking Range Corporation
111 Front Street
Greenwood, Mississippi 38930 USA
(662) 455-1200

For product information,
call 1-888-VIKING1 (845-4641)
or visit the Viking Web site at
vikingrange.com

AjMadison
Your Appliance Authority™
800-570-3355

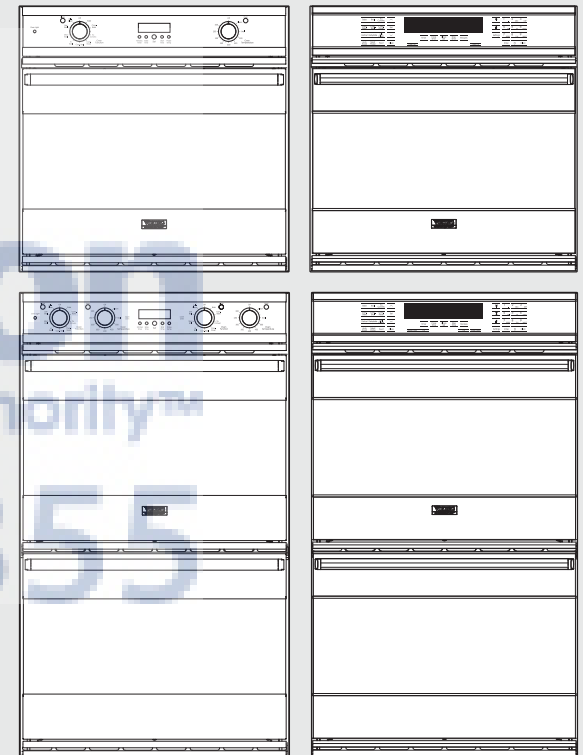

Designer Series Built-In Electric
Single and Double Ovens



Table of Contents

Warnings & Important Safety Information	3
Dimensions	5
Specifications	6
Cutout Dimensions	7
Electrical Requirements	8
General Information	9
Installation	10
Final Preparation	13
Performance Checklist	14
Service & Registration	16

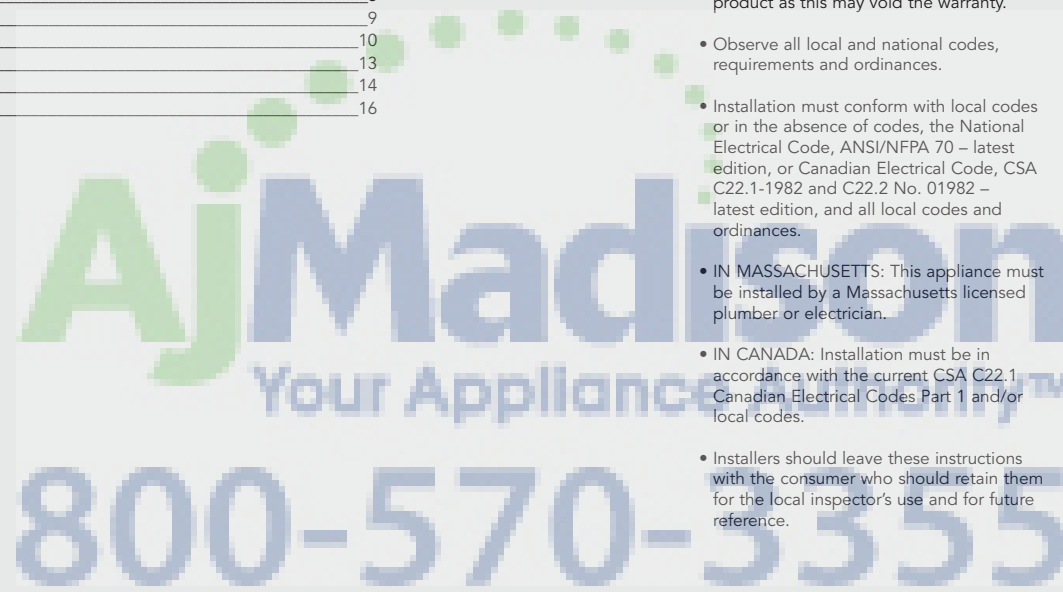

IMPORTANT— Please Read and Follow

- Before beginning installation, read these instructions thoroughly and carefully.
- **DO NOT** remove permanently affixed labels, warnings or plates from the product as this may void the warranty.
- Observe all local and national codes, requirements and ordinances.
- Installation must conform with local codes or in the absence of codes, the National Electrical Code, ANSI/NFPA 70 – latest edition, or Canadian Electrical Code, CSA C22.1-1982 and C22.2 No. 01982 – latest edition, and all local codes and ordinances.
- IN MASSACHUSETTS: This appliance must be installed by a Massachusetts licensed plumber or electrician.
- IN CANADA: Installation must be in accordance with the current CSA C22.1 Canadian Electrical Codes Part 1 and/or local codes.
- Installers should leave these instructions with the consumer who should retain them for the local inspector's use and for future reference.

Your safety and the safety of others is very important.

We have provided many important safety messages in this manual and on your appliance. **ALWAYS** read and obey all safety messages.

 This is the safety alert symbol. This symbol alerts you to hazards that can kill or hurt you and others.

All safety messages will be preceded by the safety alert symbol and the word "DANGER," "WARNING" or "CAUTION." These words mean:

 DANGER
Hazards or unsafe practices which WILL result in severe personal injury or death

 WARNING
Hazards or unsafe practices which COULD result in severe personal injury or death

 CAUTION
Hazards or unsafe practices which COULD result in minor personal injury or property damage.
 All safety messages will identify the hazard, tell you how to reduce the chance of injury, and tell you what can happen if the instructions are not followed.

Site Preparation: It is recommended that a thorough site inspection be conducted PRIOR to unpacking and moving this appliance.

Note: Wiring diagram is located on top of oven or in control panel.

IMPORTANT— Please Read and Follow

Dimensions

⚠ WARNING
DO NOT use the handle or oven door to lift the oven. Remove door before installation to ensure that it is not used to lift the unit. See installation section for door removal.

⚠ WARNING
 The misuse of the oven door(s) (e.g. stepping, sitting, or leaning on them) can result in hazards or injuries and damage to the product.

⚠ WARNING
ELECTRICAL GROUNDING INSTRUCTIONS
 This oven must be electrically grounded in accordance with local codes or, in the absence of local codes, with the National Electrical Code, ANSI/NFPA 70 – latest edition.

⚠ WARNING
 Frame grounded by a 4-conductor cable assembly. See installation section.
DO NOT USE AN EXTENSION CORD WITH THIS APPLIANCE. SUCH USE MAY RESULT IN FIRE, ELECTRICAL SHOCK OR OTHER PERSONAL INJURY.

⚠ WARNING
 This appliance should **not** be used for space heating. This information is based on safety considerations.

⚠ WARNING
 The use of cabinets for storage above the oven may result in potential fire or burn hazard.

⚠ CAUTION
 The oven is heavy—use extreme care when handling.

30" Single Oven

30" Double Oven

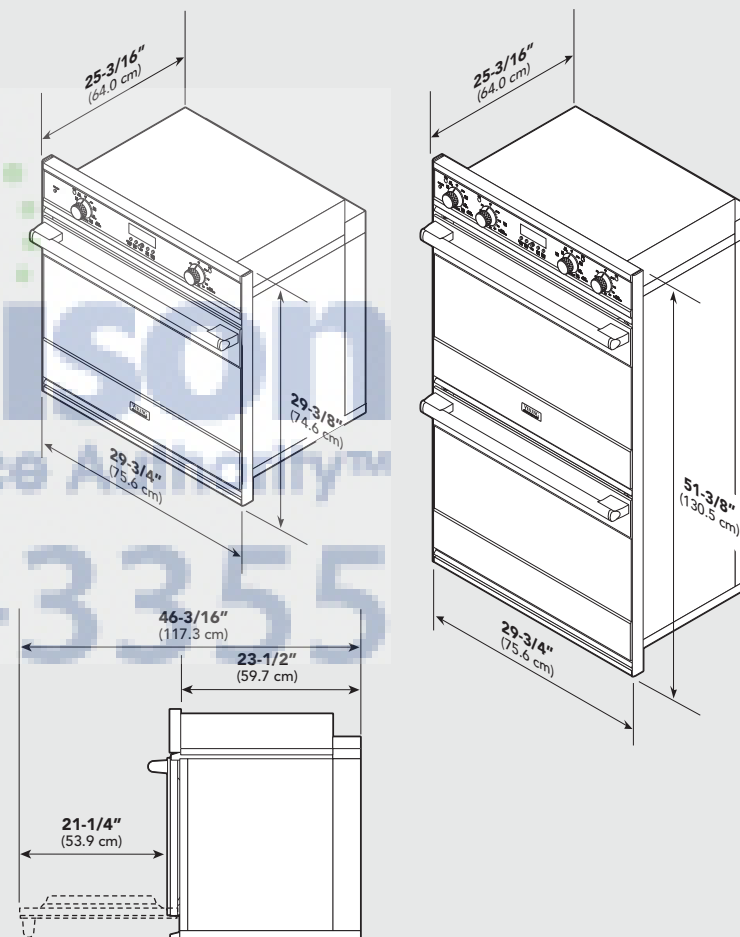

Specifications

Designer Ovens		
Description	DSOE301/DSOE305T	DDOE301(T)/DDOE305(T)
Overall width	29-3/4" (75.6 cm)	
Overall height	29-3/8" (74.6 cm)	51-3/8" (130.5 cm)
Overall depth	To front of door 25-3/16" (64.3 cm)	
Cutout width	Standard—28-1/2" (72.4 cm minimum) Flush mount*—29-5/8" (75.25 cm)	
Cutout height	Standard—28-1/4" (71.8 cm) Flush mount*—29-1/2" (74.9 cm)	Standard—50-5/8" (128.6 cm) Flush mount*—51-1/2" (130.8 cm)
Cutout depth	Standard—24" (61.0 cm) Flush mount*—25-1/4" (64.1 cm)	
Electrical requirements	4-wire ground, 240 VAC, 30 amp electrical connection for single ovens/ 50 amp for double ovens. Unit is equipped with No. 10 ground wire in conduit. Should be fused separately.	
Maximum amp usage	23.3 amps—240 VAC 20.2 amps—208 VAC	46.7 amps—240 VAC 40.5 amps—208 VAC
Oven interior width	24-3/4" (62.9 cm)	
Oven interior height	15-3/4" (40.0 cm)	
Oven interior depth	18" (45.7 cm)	Upper—18" (45.7 cm) Lower—19" (48.3 cm)
Oven volume (measured to AHAM Standard)**	4.1 cu. ft.	Upper—4.1 cu. ft. Lower—4.1 cu. ft.
Oven volume (total oven cavity)	4.3 cu. ft.	Upper—4.3 cu. ft. Lower—4.5 cu. ft.

***Note:** To install the oven in a flush mount application the flush mount accessory kit (D30FTS for single ovens and D30FTD for double ovens) is required.

****Note:** The AHAM Standard for measuring oven capacity subtracts the door plug and convection baffle dimension from the total oven volume.

Cutout Dimensions

(For standard installation and flush mount* installations)

30" Double Oven Built-In

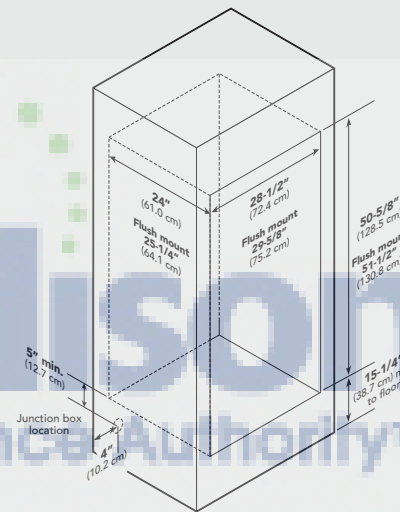

30" Single Oven Built-In

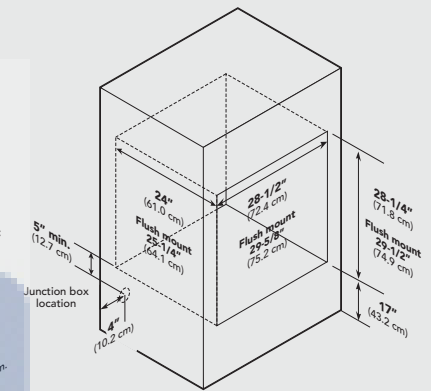

30" Single Oven Undercounter

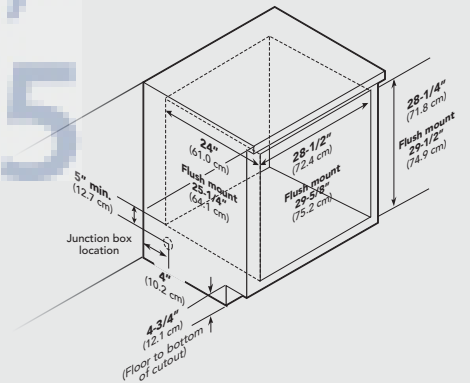

***Note:** To install the oven in a flush mount application the flush mount accessory kit (D30FTS for single ovens and D30FTD for double ovens) is required.

Electrical Requirements

- Oven requires a separate, grounded 4-wire, 240V (AC), 30 amp (single ovens) and 50 amp (double ovens) service with its own circuit breaker.
- Wire sizes and connections must conform with the rating of the appliance and to the requirements of the National Electrical Code, ANSI/NFPA 70 – latest edition, or Canadian Electrical Code, CSA C22.1-1982 and C22.2 No. 01982 – latest edition, and all local codes and ordinances.
- Oven must be connected to the proper electrical voltage and frequency as specified on the model/serial rating plate (located inside the vent on the right side of the oven).
- Oven must be connected to grounded metal permanent wiring system. Check with a qualified electrician to make sure the oven is properly grounded.
- **DO NOT** ground to a gas pipe.
- **DO NOT** use an extension cord with this appliance, because this may result in electrical shock or other personal injury.
- This unit is equipped with a No. 10 ground wire in the conduit.
- The electrical conduit must be kept to the top left for a flush installation. **NEVER** cut the conduit.
- Connect the flexible armored cable directly to 4-wire, 240V household service. If codes permit and separate grounding wiring is used, we recommend that a qualified electrician determine the grounding path and that the wire gauge is in accordance with local codes.
- Junction boxes installed on rear wall directly behind oven must be recessed.
- A UL-Listed conduit connector must be provided at the junction box.
- **DO NOT** install a fuse in the neutral or grounding circuit. We recommend a time-delayed fuse or circuit breaker. Connect directly to the fused disconnect (or circuit breaker box) through flexible armored, or non-metallic sheathed, copper cable (with grounding wire).

General Information

- All openings in the wall behind the appliance or in the floor under the appliance should be sealed.
- Keep appliance area clear and free from combustible materials, gasoline and other flammable vapors.
- Disconnect the electrical supply prior to servicing or cleaning.
- When removing the appliance for cleaning or service, disconnect AC power supply and carefully remove the appliance by pulling forward.
- Detach the product from the metal anchor strip by removing the attachment screw.
- **DO NOT** remove the protective wrapping from the product control panel until the product is installed.

Recommendations for Moving

⚠ CAUTION

The oven is heavy—use extreme care when handling.

⚠ WARNING

DO NOT use the handle or oven door to lift the oven. Remove door before installation to ensure that it is not used to lift the unit. **DO NOT** lift or carry the door by the handle.

- Electrical requirements are listed in the product specifications under the electrical requirements section.

Recommendations for Unpacking

- Products are shipped on pallets with foam footings and corrugated inner-packing and exterior hoods.
- Products are anchored to the pallet using metal straps that are screwed to the bottom of the product and the pallet.
- **DO NOT** remove protective packaging until you are ready to perform the installation.
- To remove the packaging, first remove the staples located at the bottom perimeter of the corrugated cover.
- Remove the corrugated cover by lifting it off the product and remove the inner-packing.
- Only proper equipment should be used to move products.
- **ALWAYS** take steps to protect flooring at the installation location when moving products.

General Information

Site Preparation

Note: It is recommended that a thorough site inspection be conducted **PRIOR** to unpacking and moving this appliance.

⚠ WARNING

FIRE OR ELECTRICAL SHOCK HAZARD
DO NOT use an extension cord with this appliance. Such use may result in fire, electrical shock or other personal injury.



- Confirm available access to adequate power—see *electrical requirements*.
 - Single oven units require a 30 amp circuit
 - Double oven units require a 50 amp circuit
- It is recommended that 3/4" or thicker material be utilized to create a support platform for this appliance.

- **BE SURE** that support for this appliance is perpendicular to the front facing of the wall or cabinet before you perform the installation.
- Use of a hydraulic lift is recommended for the installation of double oven units. Be careful not to bend lower trim/vent.
- All openings in the wall behind the appliance or in the floor under the appliance should be sealed.
- Keep appliance area clear and free from combustible materials, gasoline and other flammable vapors.

⚠ WARNING

DO NOT use the handle or oven door to lift the oven. Remove door before installation to ensure that it is not used to lift the unit. **DO NOT** lift or carry the door by the handle.

Installation

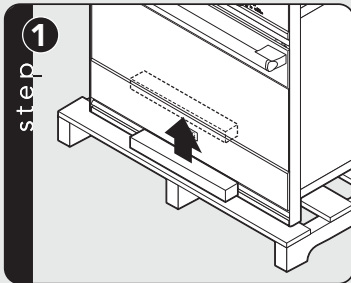

Remove wooden brace on front of pallet.

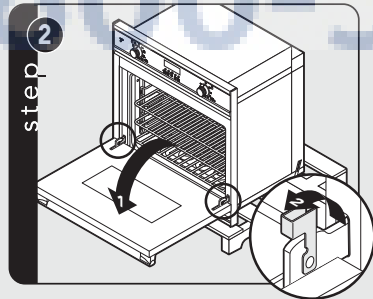

Open door completely. Rotate door hinge to unlocked position.

Installation (cont.)

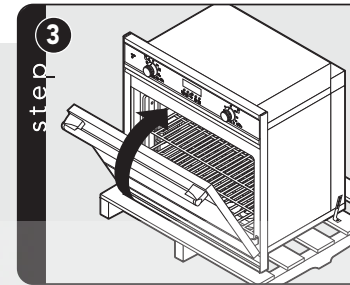

Close the door until it stops.

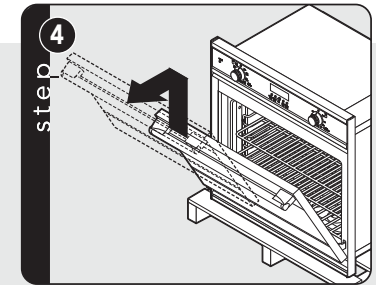

Push in/lift door up/and then out. Repeat for all doors.

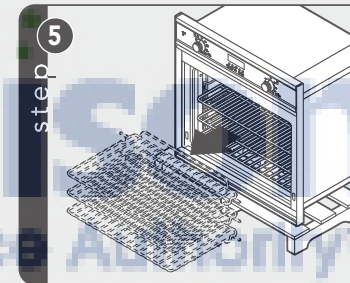

Remove racks.

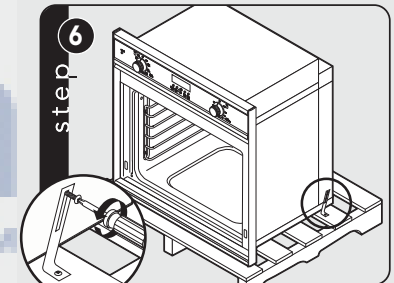

Unscrew pallet screws from side of oven.

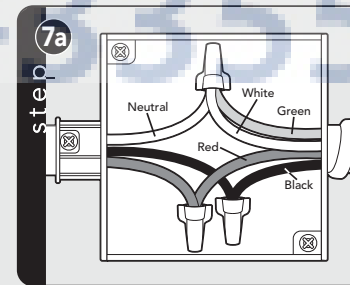

Wiring option 1*
(connect the white and green to the incoming neutral)

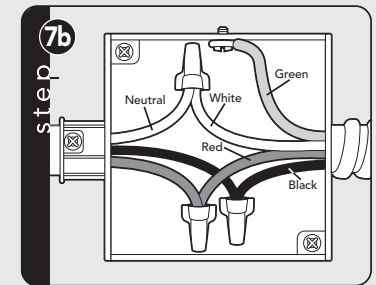

Wiring option 2*
(connect the white to the incoming neutral, attach green to grounded junction box)

***Note:** Check local code to see which wiring option should be used when grounding the unit.

Installation (cont.)

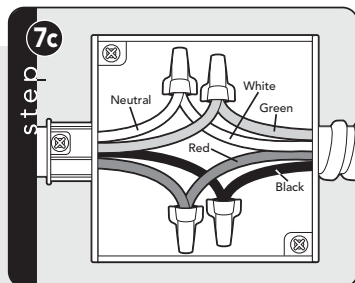

Wiring option 3*
(connect the white to the incoming neutral, attach green to suitable ground)

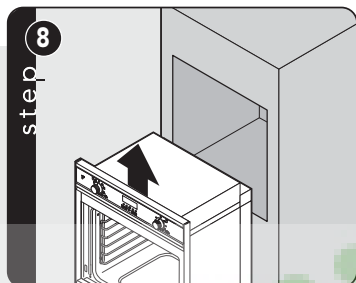

Lift oven into position.

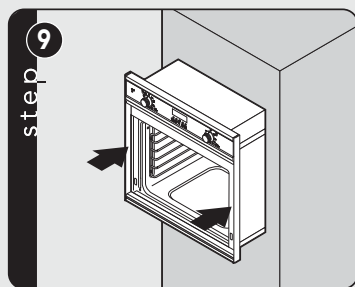

Push oven straight in.

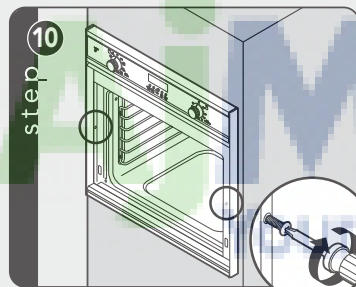

Attach screws to the side of the framing.
Note: Two screws for single ovens, four screws for double ovens (screws not included).

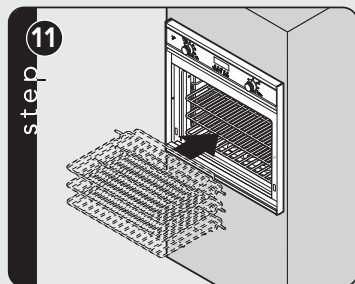

Replace racks.

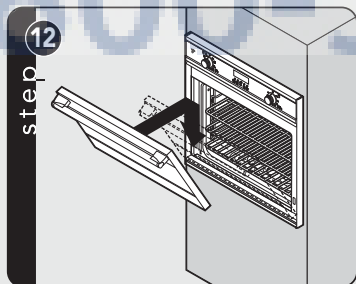

Replace door.

*Note: Check local code to see which wiring option should be used when grounding the unit.

Installation

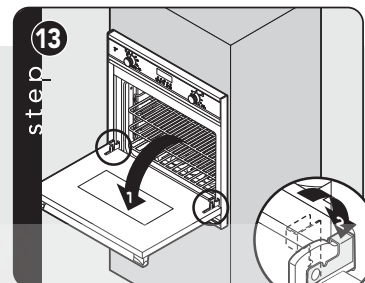

Open door completely. Rotate door hinge to locked position.

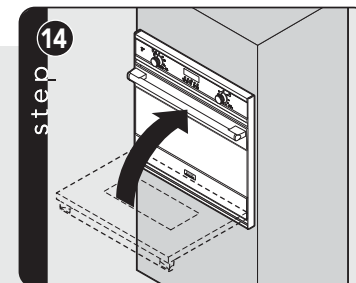

Close door.

Final Preparation

1. Some stainless steel parts may have a protective wrap, which must be peeled off. All stainless steel body parts should be wiped regularly with hot, soapy water at the end of each cooling period and with liquid cleaner designed for this material when soapy water will not do the job. If build-up occurs, **DO NOT** use steel wool, or abrasive cloths, cleaners, or powders. If it is necessary to scrape stainless steel surface to remove encrusted material, soak area with hot, wet towels to loosen the material, then use a wooden or nylon spatula or scraper. **DO NOT** use a metal knife, spatula, or any other metal tool to scrape stainless steel surfaces. Scratches are almost impossible to remove.

2. The interior of the oven should be washed thoroughly with hot, soapy water to remove film residues and installation debris before being used for food preparation, then rinsed and wiped dry. Solutions stronger than soapy water are rarely needed.

Performance Checklist

A qualified installer should carry out the following checks:

- Check oven Bake Function—bake element on full power, center and outside broil elements at partial power. Convection Bake function—bake and broil elements the same with the convection fan “ON”.
- Check TruConvect™ function—TruConvect element (behind convection fan cover) “ON” and convection fan “ON”.
- Check High Broil function—both broil elements at full power. Convection broil function is the same with convection fan “ON”.
- Check Medium Broil function—inner and outer broil elements pulse on and off.
- Check Low Broil function—inner broil element only.
- Check Self-Clean function—Door will lock in approximately 30 seconds, the center and outside broil elements will turn “ON” and the bake element will turn “ON” at partial power. Check broil elements through window to make sure they are “ON”, then abort self-clean cycle to unlock door.

CAUTION
DO NOT run self-clean cycle check for more than 10 minutes with the oven racks and rack supports inside oven to avoid discoloration due to the high temperature.

Any adjustments necessary that are a result of the installer not following instructions will be the responsibility of the installer, dealer, or the end user of the product.

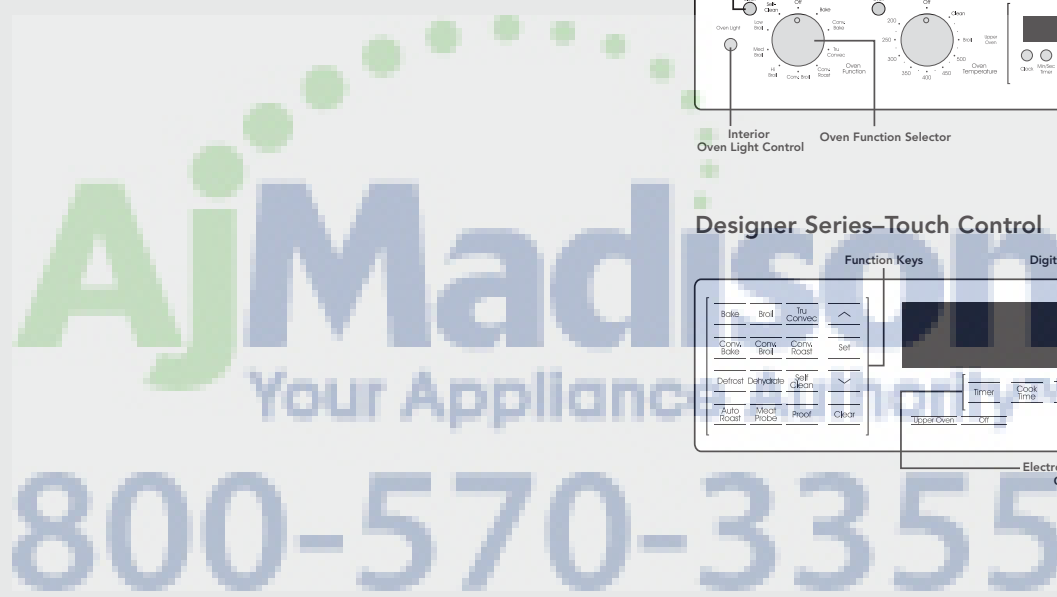

Performance Checklist (cont.)

Designer Series

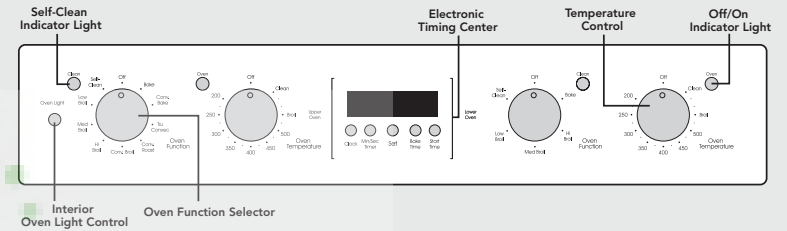

Designer Series—Touch Control

