



**Designer Built-In Electric Radiant
30"/36"/45"W. Glass Ceramic Cooktop**

Standard Features & Accessories

All models include

- Dimensioned to fit the majority of similarly sized cooktop cutouts
- QuickCook™ surface elements utilize ribbon element technology to reach full power in about 3 seconds
- Strong, wear-resistant glass ceramic top offers excellent cleanability
- Heavy-duty stainless steel control knobs with childproof, push-to-turn safety feature

4B model includes

- Four elements
 - Left front—7" 1,800 watts
 - Left rear—7" 1,800 watts

- Bridge—800 watts
- Right rear (dual element)—9" 2,500 watts – 6" 1,000 watts
- Right front—6-1/2" 1,500 watts

5B model includes

- Five elements
 - Left front—7" 1,800 watts
 - Left rear—7" 1,800 watts
 - Bridge—800 watts
 - Center (dual element)—9" 2,500 watts – 6" 1,000 watts
 - Right rear (dual element)—8-1/4" 2,200 watts – 4-3/4" 750 watts
 - Right front—6-1/2" 1,500 watts

6B model includes

- Six elements
 - Left front—7" 1,800 watts
 - Left rear—7" 1,800 watts
 - Bridge—800 watts
 - Left center (dual element)—9" 2,500 watts – 6" 1,000 watts
 - Right center—6" 1,200 watts
 - Right rear (dual element)—8-1/4" 2,200 watts – 4-3/4" 750 watts
 - Right front—6-1/2" 1,500 watts

Model Options



**DECUC105-4B
30"W. Four-Element
Cooktop**

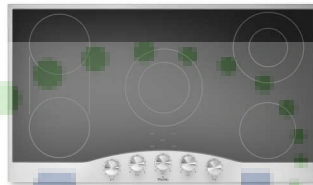

**DECUC165-5B
36"W. Five-Element
Cooktop**



**DECUC155-6B
45"W. Six-Element
Cooktop**

FINISH DETAILS FOR BOTH MODELS

- Stainless Steel/Black (SB)
 - Stainless steel trim, control panel, and knobs
 - Black glass and knob grips
- Stainless Steel/White (SW)
 - Stainless steel trim, control panel, and knobs
 - White glass with gray knob grips
- Brass Trim Option (BR) Brass finish—knobs. Brass components have a durable protective coating for maintenance-free normal use.

ORDERING INSTRUCTIONS

First specify model number, and then color code (DECUC105-4BSS). If ordering optional brass trim, specify code at end (DECUC105-4BSSBR).



**Designer Built-In Electric Radiant
30"/36"/45"W. Glass Ceramic Cooktop**

Dimensions & Specifications

PRODUCT DIMENSIONS—OVERALL



DECU105-4B
30"W. Four-Element
Cooktop



DECU165-5B
36"W. Five-Element
Cooktop



DECU155-6B
45"W. Six-Element
Cooktop

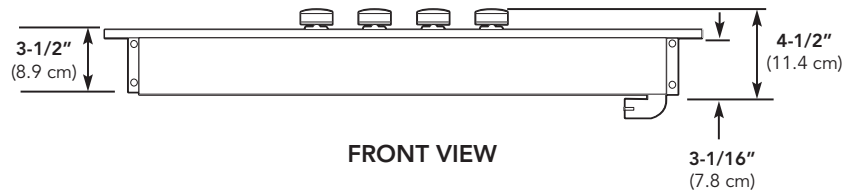
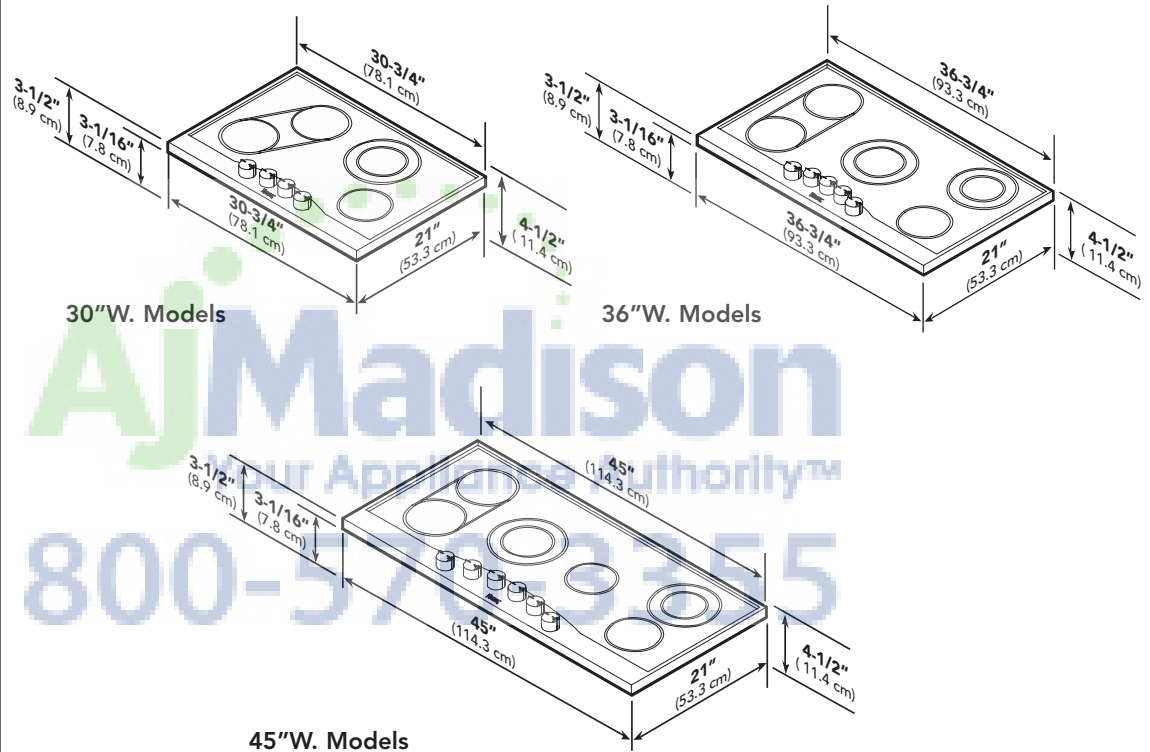

	DECU105-4B	DECU165-5B	DECU155-6B
Overall width	30-3/4" (78.1 cm)	36-3/4" (93.3 cm)	45" (114.3 cm)
Overall height (from bottom)			
To top of knobs		4-1/2" (11.4 cm)	
To top of cooking surface		3-1/2" (8.9 cm)	
To bottom edge of frame		3-1/16" (7.8 cm)	
Overall depth (from rear)	21" (53.3 cm)	21" (53.3 cm)	21" (53.3 cm)



**Designer Built-In Electric Radiant
30"/36"/45"W. Glass Ceramic Cooktop**

Dimensions & Specifications

CLEARANCE DIMENSIONS

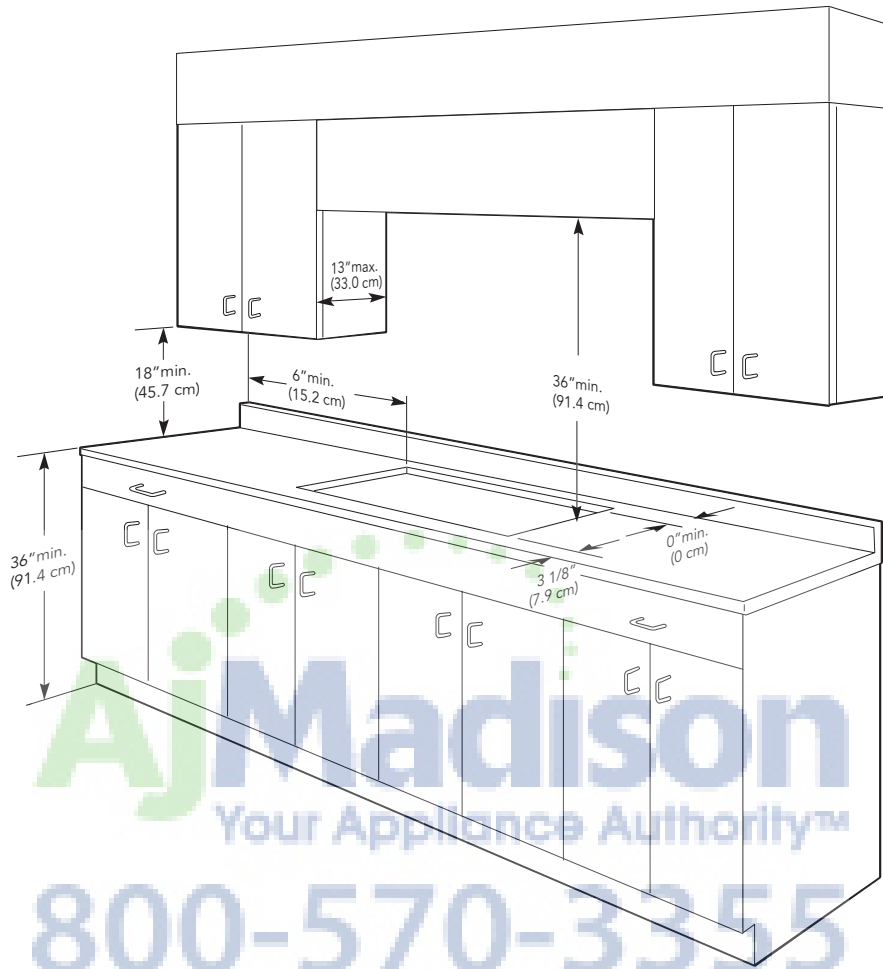

Minimum clearances from adjacent combustible construction

- Above countertop (36" [91.4 cm])
- Sides—6" (15.2 cm)
- Rear—0" (0 cm)
- Within 6" side clearance; wall cabinets no deeper than 13" (33.0 cm)
- Must be minimum 18" (45.7 cm) above countertop
- Wall cabinets directly above cooktop must be minimum 36" (91.4 cm) above the countertop.

1. The cooktop may be installed directly to existing base cabinets.
2. The cooktop **cannot** be installed directly adjacent to sidewalls, tall cabinets, tall appliances, or other side vertical surfaces above 36" (91.4 cm) high. There must be a minimum of 6" (15.2 cm) side clearance from the cooktop to such combustible surfaces above the 36" (91.4 cm) counter height.
3. Within the 6" (15.2 cm) side clearance

to combustible vertical surfaces above 36" (91.4 cm), the maximum wall cabinet depth must be 13" (33.0 cm) and wall cabinets within this 6" (15.2 cm) side clearance must be 18" (45.7 cm) above the 36" (91.4 cm) high countertop.

4. Wall cabinets above the cooktop must be a minimum of 36" (91.4 cm) above the countertop for a full width of the cooktop. This minimum height requirement does **not** apply if a hood is installed over the cooking surface.

The bottom of the hood should be 30" (76.2 cm) min. to 36" (91.4 cm) above the countertop. This would typically result in the bottom of the hood being 66" (167.6 cm) to 72" (182.9 cm) above the floor. Refer to the hood installation instructions for further information.

Warning

The use of cabinets for storage above the appliance may result in a potential

burn hazard. If a cabinet storage is to be provided the risk can be reduced by installing a hood that projects horizontally a minimum of 5" (12.7 cm) beyond the bottom of the cabinets.



**Designer Built-In Electric Radiant
30"/36"/45"W. Glass Ceramic Cooktop**

**UTILITY
REQUIREMENTS**



GAS

- Not applicable



ELECTRICAL

- 4-foot (121.9 cm) flexible conduit included*
- 3-wire conduit with a No. 10 ground wire
- 240 – 208/120 V/60 Hz
- Maximum amp usage—(240V/208V)
 - 4B—35.0/30.0
 - 5B—44.0/34.0
 - 6B—49.0/42.0
- **Do not use an extension cord with this appliance.**



PLUMBING

- Not applicable

Installation Requirements

ACCESS REQUIREMENTS



**DECU105-4B
30"W. Four-Element
Cooktop**



**DECU165-5B
36"W. Five-Element
Cooktop**



**DECU155-6B
45"W. Six-Element
Cooktop**

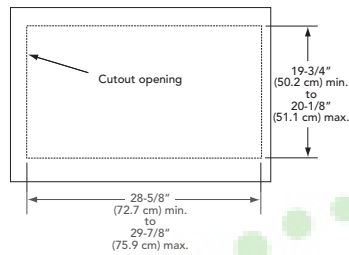

30"W. Cutout

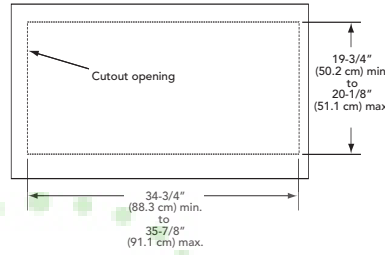

36"W. Cutout

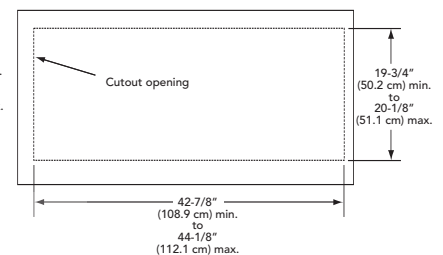

45"W. Cutout

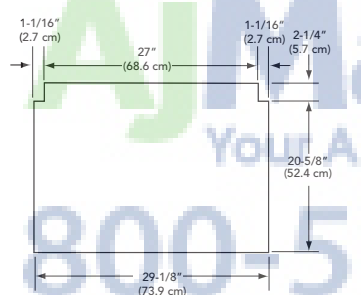

**30"W. Cutout
w/Downdraft**

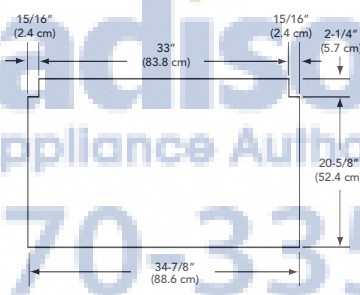

**36"W. Cutout
w/Downdraft**

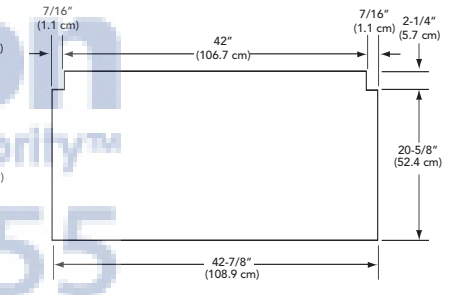

**45"W. Cutout
w/Downdraft**

Note: Before cutting countertop cutout, check the inside clearance available from the inside back wall to the proposed placement of the cooktop. A minimum of 1-3/4" (4.4 cm) is required from the back wall of the cooktop to the **inside** wall of the back cabinet. This may require a distance greater than the 0" minimum approved distance.

	DECU105-4B		DECU165-5B		DECU155-6B	
Cutout width	28-5/8" (72.7 cm) min. 29-7/8" (75.9 cm) max.		34-3/4" (88.3 cm) min. 35-7/8" (91.9 cm) max.		42-7/8" (108.9 cm) min. 44-1/8" (112.1 cm) max.	
Cutout height	3-1/8" (7.9 cm) min.					
With conduit	4-1/8" (10.5 cm)					
Cutout depth	19-3/4" (50.2 cm) min. to 20-1/8" (51.1 cm) max.					
Surface burner rating	<u>240V</u>	<u>208V</u>	<u>240V</u>	<u>208V</u>	<u>240V</u>	<u>208V</u>
Right front	1,500 watts	1,125 watts	1,500 watts	1,125 watts	1,500 watts	1,125 watts
Right rear (dual element)	2,500/1,000 watts/1,875/750 watts		2,200/ 1,000 watts	1,650/ 562 watts	2,200/ 950 watts	1,650 watts
Center right	N/A		N/A		1,200 watts 900 watts	
Center (dual element)	N/A		2,500/ 1,000 watts	1,875/ 750 watts	N/A	
Center left (dual element)	N/A		N/A		2,500/ 1,000 watts	1,875/ 750 watts
Left front	1,800 watts	1,350 watts	1,800 watts	1,350 watts	1,800 watts	1,350 watts
Bridge	800 watts	600 watts	800 watts	600 watts	800 watts	600 watts
Left rear	1,800 watts	1,350 watts	1,800 watts	1,350 watts	1,800 watts	1,350 watts



Compliance Information



WARRANTY INFORMATION*

- One-year full warranty—complete product
- Five-year limited warranty—surface burners and electric elements
- Ninety-day limited warranty—cosmetic parts such as glass, painted, and decorative items

* For complete warranty see *Use & Care Guide*. Warranty valid on Viking products shipped within the United States and Canada.