

JPH/C2 Series Equipped with LED lighting. Not available with heat lamps. Optional duct covers available in standard and custom sizes.

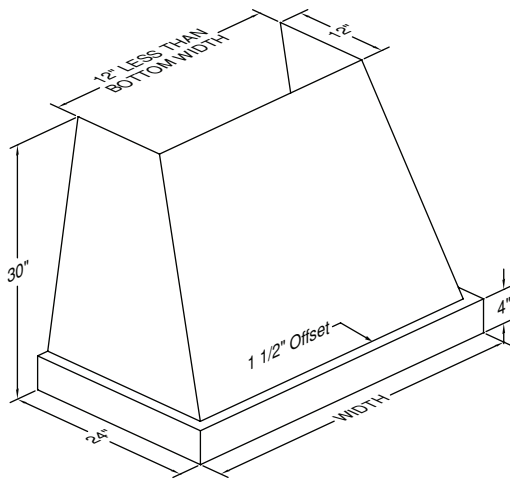

Recommended Mounting Height

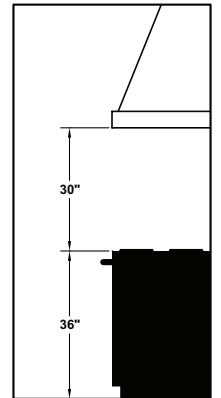

*Recommended mounting height is for optimum performance.

Connection Diagrams (36" - 48" Widths)

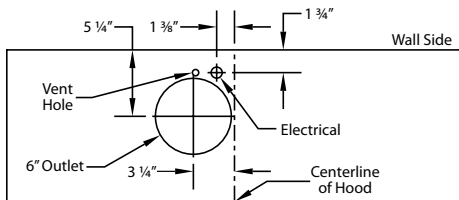

B100 Single Blower (Top View)

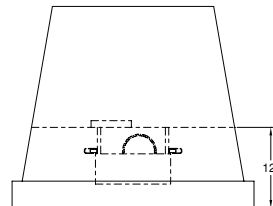

(Front View)

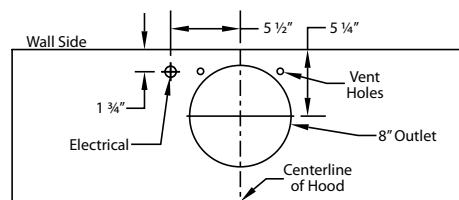

B200 Dual Blower (Top View)

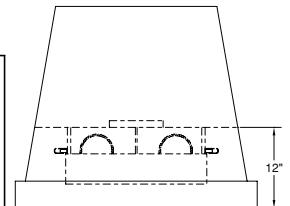

(Front View)

Connection Diagram (48" - 60" Widths)

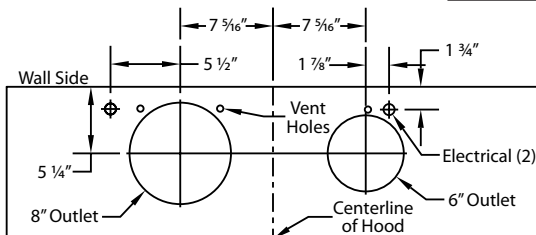

900 CFM B200 Dual & B100 Single Blower (Top View)

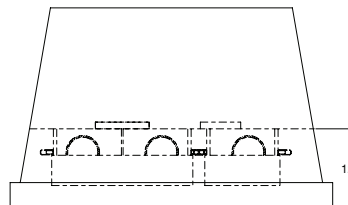

(Front View)

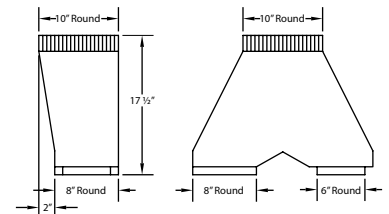

VP562 Standard Transition Optional

Connection Diagram (54" - 66" Widths)

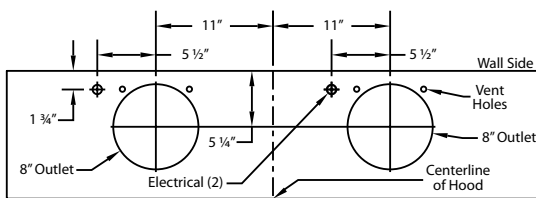

1200 CFM Double B200 Dual Blowers (Top View)

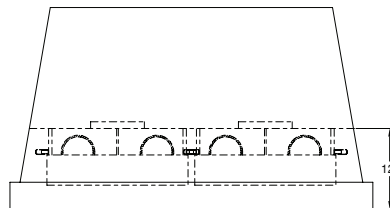

(Front View)

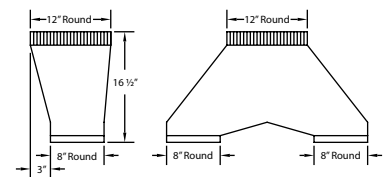

VP563 Standard Transition Optional

Electrical/Mechanical Specifications For Blower Units

Model	Volts	Amps	Hz	RPM	CFM SP@0.0"	Equivalent CFM*	CFM SP@0.1"	CFM SP@0.2"	CFM SP@0.3"	Minimum Round Duct Size	Sones#
B100 Single	115	2.5	60	1550	300	450	273	245	225	6" (28 in. ²)	5.4
B200 Dual	115	4.0	60	1550	600	900	531	480	430	8" (50 in. ²)	6.5
B200 Dual & B100 Single	115	6.0	60	1550	900	1350	804	725	655	VP562: 10" (79 in. ²)	6.3
Two B200 Duals	115	7.5	60	1550	1200	1800	1062	960	860	VP563: 12" (113 in. ²)	6.6

Hoods are available with LED lights (2 lights: 30" - 41", 3 lights: 42" - 53", 4 lights: 54" - 66").

* Because the Magic Lung® blower uses centrifugal filtration rather than conventional baffle or mesh filters, the Magic Lung® blower can handle cooking equipment with higher cubic feet per minute (CFM) requirements and can deliver equivalent CFM much more efficiently than other than other filtration systems. When comparing the Magic Lung® with other blower units made by other manufacturers, use the "Equivalent CFM".

Ratings in accordance with the Standard Test Code by the Energy Systems Laboratory of the Texas Engineering Experiment Station.



Read and Save These Instructions
All Hoods Must Be Installed By A Qualified Installer

INSTALLATION INSTRUCTIONS

JPH/C2 DESIGNER SERIES

WALL MOUNT HOOD

Read All Instructions Thoroughly Before Beginning Installation

WARNING - TO REDUCE THE RISK OF FIRE, ELECTRIC SHOCK, OR INJURY TO PERSONS, OBSERVE THE FOLLOWING:

- A. Installation work and electrical wiring must be done by qualified person(s) in accordance with all applicable codes and standards, including fire-rated construction. Switch power off at service panel and lock the service disconnecting means to prevent power from being switched on accidentally during installation.**
- B. When cutting or drilling into wall or ceiling, do not damage electrical wiring and other hidden utilities.**
- C. Ducted fans must always be vented to the outdoors.**
- D. Sufficient air is needed for proper combustion and exhausting of gases through the flue (chimney) of fuel burning equipment to prevent back drafting. Follow the heating equipment manufacturer's guideline and safety standards such as those published by the National Fire Protection Association (NFPA), and the American Society for Heating, Refrigeration and Air Conditioning Engineers (ASHRAE), and local code authorities.**
- E. ASHRAE residential ventilation standard 62.2 limits exhaust fans (total) to a maximum of 15 CFM per 100 square feet of occupiable space, unless a back drafting test is performed or make-up air is provided. Consult a local HVAC engineer for make-up air evaluation.**

WARNING - TO REDUCE THE RISK OF FIRE, USE ONLY METAL DUCTWORK



Vent-A-Hood®

Ducting Do's and Don'ts

General Requirements

- Observe local codes regarding special duct requirements and placement of duct against combustibles.
- Using Vent-A-Hood transitions (back page) will ensure proper efficiency.
- Using Vent-A-Hood roof jacks or wall louvers (back page) will ensure proper efficiency.
- Where possible, seal joints with duct tape.
- The hood must be ducted to the outdoors without restrictions.

Blower Requirements

- The single blower unit (B100) requires 6" round duct or equivalent (28 square inches), and the dual blower unit (B200) requires 8" round duct or equivalent (50 square inches).

Blower	Combined Duct Dize	Sq. Inch Area	Vent-A-Hood Transition
Single (B100)	6" round or equivalent	28 sq. in.	N/A
Dual (B200)	8" round or equivalent	50 sq. in.	N/A
Single and Dual (B100 & B200)	10" round or equivalent	79 sq. in.	VP562 (Optional)
Two Duals (Two B200s)	12" round or equivalent	113 sq. in.	VP563 (Optional)

Ducting Requirements

- NEVER reduce the duct size.
- When combining ducts together, the square inch area must reflect the total square inch area of the ducts being combined.
- Do not use flexible or corrugated duct. This type of duct will restrict airflow and reduce performance.
- Only use smooth, galvanized, metal duct.
- Make the duct run as short and as straight as possible with as few turns as possible.
- Avoid sharp-angled turns. Instead, use smooth, gradual turns such as adjustable elbows or 45 degree angled turns.
- For duct runs over 20 feet, increase the duct diameter by one inch for every ten feet of duct.
- A 90 degree elbow is equal to 5 feet of duct.

Termination Requirements

- Airflow must not be restricted at the end of the duct run.
- A wall louver or roof jack is required for each duct run.
- Every wall louver or roof jack must include a gravity damper to prevent back drafts.
- Do not use screen wire or spring-loaded doors on wall louvers or roof jacks.
- Do not terminate venting into an attic or chimney.

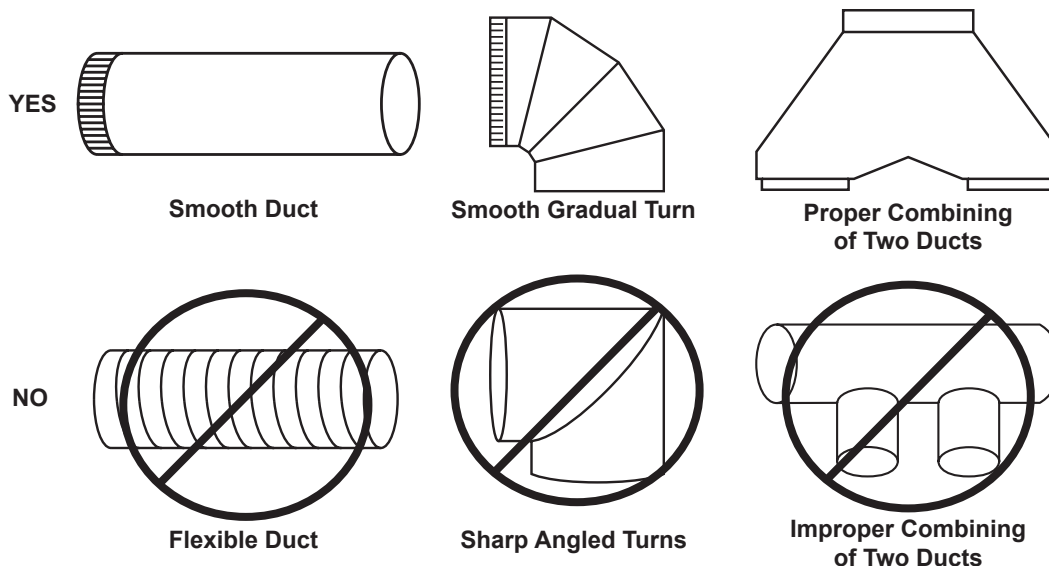

Vent-A-Hood®

Installation Details

- 1) Read all instructions thoroughly before beginning installation.
- 2) When installing a JPH/C2 wall mount range hood, it is recommended that the bottom edge of the hood be located no more than 30" above the cooking surface for optimum performance.

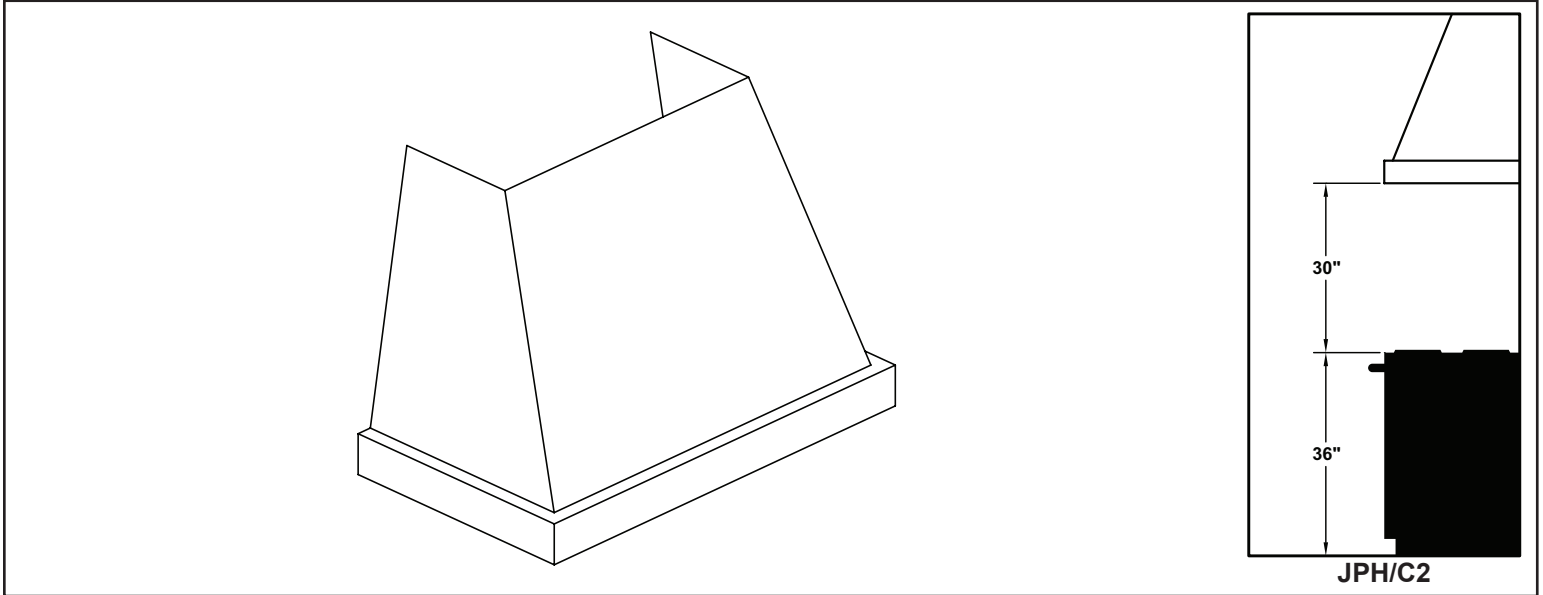

- 3) IF THE HOOD IS TO BE "BACK VENTED", PROCEED DIRECTLY TO STEP 4.

Consult the connection diagrams (on next page) for further details on exhaust outlet placement.

Install the duct(s) from the outside of the home to the ceiling over the exhaust outlet(s) on the hood. The end of the duct(s) should extend 1" below the ceiling.

Use duct tape to seal all joints. A complete listing of available Vent-A-Hood ducting materials is provided on the back page of this instruction sheet.

Transition heights are as follows:

- | | |
|---------------------------------------|--|
| Single Blower (B100): | 6" round duct will connect directly to the top of the hood. |
| Dual Blower (B200): | 8" round duct will connect directly to the top of the hood. |
| Single and Dual Blower (B100 & B200): | 6" round duct will connect directly to the top of the hood; 8" round will connect directly to the top of the hood. Optional 10" round combination transition (VP562, sold separately) is 17 1/2" tall. |
| Two Dual Blowers (Two B200s): | Two 8" round ducts connect directly to the top of the hood. Optional 12" round combination transition (VP563, sold separately) is 16 1/2" tall. |

Installation Details Continued

Connection Diagram (36" - 48" Widths)

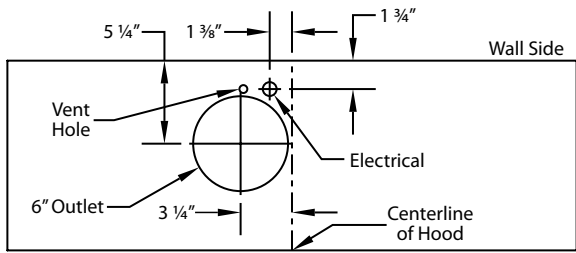

**300 CFM B100 Single Blower
(Top View)**

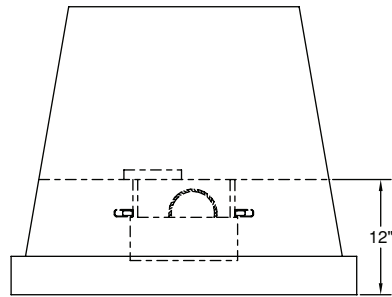

(Front View)

Connection Diagram (36" - 48" Widths)

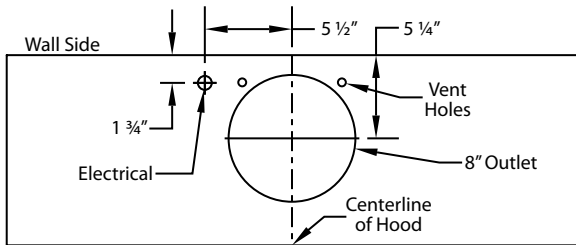

**600 CFM B200 Dual Blower
(Top View)**

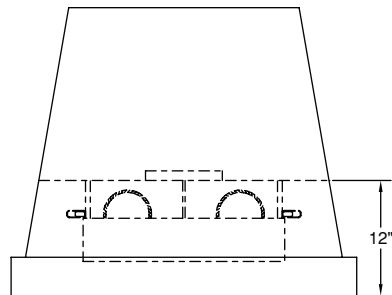

(Front View)

Connection Diagram (48" - 60" Widths)

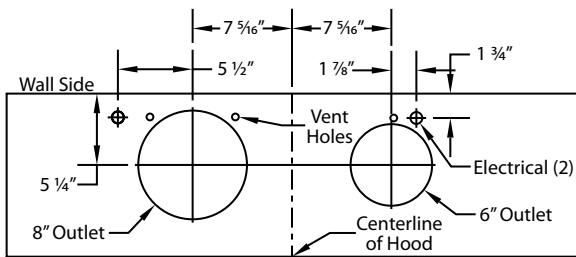

**900 CFM B200 Dual & B100 Single Blower
(Top View)**

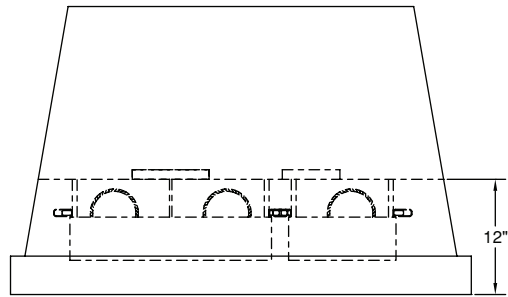

(Front View)

Connection Diagram (54" - 66" Widths)

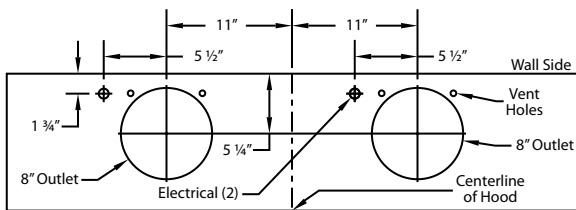

**1200 CFM Double B200 Dual Blowers
(Top View)**

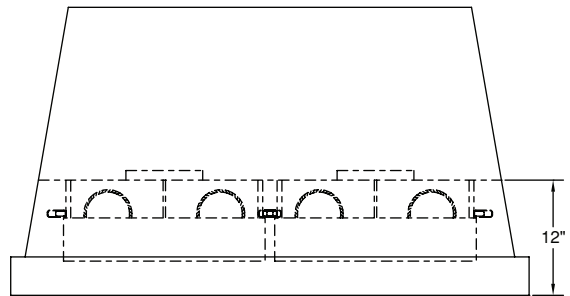

(Front View)

Vent-A-Hood®

Installation Details Continued

- Remove the hood from its packaging and place the back of the hood on the floor or countertop in front of the wall where it will hang.
- Remove the shipping tape that is securing the E-Z Clean shield(s) inside the hood. Remove the E-Z Clean shield(s) by lightly pulling it toward the front of the hood. Gently close the back draft damper(s) from the top side of the hood. To remove the blower housing(s), unsnap the suitcase latches (one on each side of the housing). The housing(s) should be pulled forward and gently “tipped” to clear the blower wheel(s) and then out of the hood.

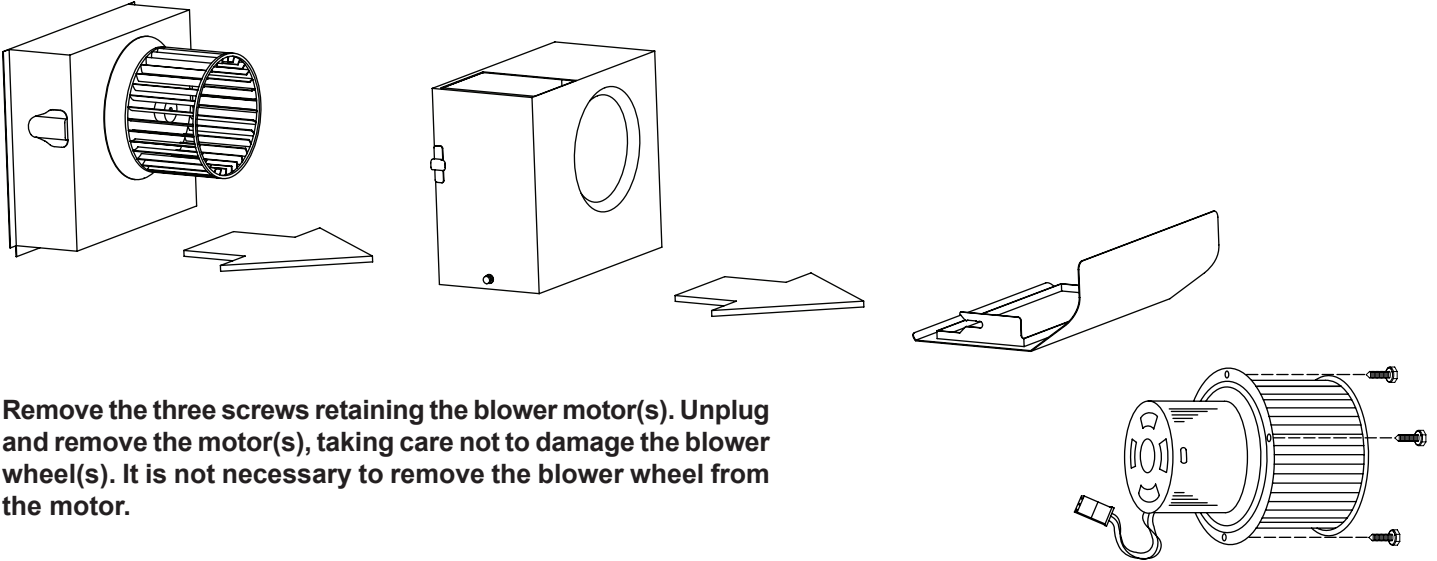

- Remove the three screws retaining the blower motor(s). Unplug and remove the motor(s), taking care not to damage the blower wheel(s). It is not necessary to remove the blower wheel from the motor.

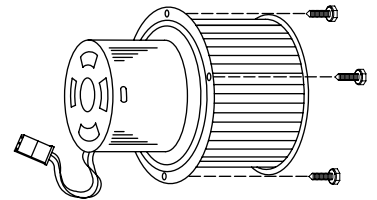

Warning: Make sure power is off and locked at the service disconnecting means on the service panel during installation.

- Install an appropriate 1/2" UL listed electrical wire clamp through each motor box electrical opening on top of the hood. Install electrical wiring from the service panel to the hood location for each motor box. Consult the connection diagrams (on previous page) for further details on electrical placement. Extend wiring to the hood. Electrical connection(s) will occur before the hood is installed on the wall.

Model	Volts	Amps	Hz	RPM	CFM SP@0.0"	Equivalent CFM*	CFM SP@0.1"	CFM SP@0.2"	CFM SP@0.3"	Minimum Round Duct Size	Sones#
B100 Single	115	2.5	60	1550	300	450	273	245	225	6" (28 in. ²)	5.4
B200 Dual	115	4.0	60	1550	600	900	531	480	430	8" (50 in. ²)	6.5
B200 Dual & B100 Single	115	6.0	60	1550	900	1350	804	725	655	10" (79 in. ²)	6.3
Two B200 Duals	115	7.5	60	1550	1200	1800	1062	960	860	12" (113 in. ²)	6.6

* Because the Magic Lung® blower uses centrifugal filtration rather than conventional baffle or mesh filters, the Magic Lung® blower can handle cooking equipment with higher cubic feet per minute (CFM) requirements and can deliver equivalent CFM much more efficiently than other than other filtration systems. When comparing the Magic Lung® with other blower units made by other manufacturers, use the "Equivalent CFM".

Ratings in accordance with the Standard Test Code by the Energy Systems Laboratory of the Texas Engineering Experiment Station.

- If using a duct cover, remove the duct cover from its packaging and remove the mounting screws from the base of the duct cover. Place the duct cover on the top of the hood and secure it through the knockout openings using the mounting screws previously removed.

Lift the hood or the hood and duct cover assembly to the location on the wall where it will be installed. Lightly mark the wall with a short, horizontal mark along the bottom edge of the hood. When finished, remove the hood or hood and duct cover assembly from the wall. If applicable, leave the duct cover installed on the hood.

- On the back side of the hood, measure the distance between the bottom edge of the hood and the top edge of the wood mounting strip. Measure this distance above the horizontal mark made in Step 8 and lightly mark the wall with a level, horizontal line. Measure where the center (left to right) of the hood will be and mark the upper, horizontal line on the wall with a short, vertical centerline.



Installation Details Continued

10) Remove the screws inside the top of the back of the hood that retain the wood strip that is recessed in the mounting channel. Note: Some retaining screws may be located behind the blower(s). Remove the wood mounting strip from the back of the hood and place the top edge of the strip on the upper, level, horizontal line on the wall. Referencing the vertical centerline from Step 9, place the mounting strip on the wall so it is centered (left to right) in the space where the hood will be located. Drill pilot holes in the strip to prevent splitting. Using proper hardware, attach the mounting strip to at least two wall studs.

11) **FOR BACK VENTING APPLICATIONS ONLY. IF NOT BACK VENTING, PROCEED DIRECTLY TO STEP 12.** Note: Wall studs may interfere with back venting installations. Additional framing may be required. It is necessary to cut duct access hole(s) in the wall prior to installing the hood.

Using the applicable venting accessories and the connection diagrams (page 4) as a guide, install the duct(s) from the outside of the home to the wall over the exhaust outlet(s) on the hood. The end of the duct(s) should extend 1" past the wall.

12) Hang the hood on the mounting strip by aligning the channel at the top of the back of the hood over the wood mounting strip on the wall. While holding the hood in place, mark locations on the mounting strip through the two mounting holes in the channel at the top of the hood. Some mounting holes may be located behind the blower(s). Remove the hood and drill 3/32" pilot holes at the center of the marks in the wood strip to prevent splitting.

13) **FOR BACK VENTING APPLICATIONS ONLY. IF YOU ARE NOT BACK VENTING, PROCEED DIRECTLY TO STEP 14.**

Place the appropriate elbow(s) on the top of the hood. Elbow(s) should be placed with the non-crimped end(s) on the inside the collar(s) of the exhaust outlet(s). Use duct tape to seal joints. Insert the electrical wire from the service panel into the electrical wire clamp on each motor box. Tighten the wire clamp(s). While securing the slack in the wire, lift the hood up to the wall and hang the hood on the mounting strip, taking care to properly align the duct connection(s) between the elbow(s) on the hood and the duct(s) in the wall. Secure the hood to the mounting strip by installing the screws (previously removed from the strip in Step 10) into the pilot holes drilled in Step 12.

SKIP STEP 14. PROCEED DIRECTLY TO STEP 15.

14) If applicable, install the transition on the insides of the exhaust collars and seal with duct tape.

Insert the electrical wire from the service panel into the electrical wire clamp on each motor box. Tighten the wire clamp(s). Cut a piece of duct for each outlet of sufficient length to meet the duct(s) in the ceiling allowing room for the transition (if applicable). If a transition is used, cut the duct to reach the transition outlet plus 1". This will allow the transition to engage 1" inside of the duct. See page 3 for transition heights. One end of the duct must be crimped to fit inside the duct in the ceiling. Insert the non-crimped end over the transition or into the exhaust collar(s) on the top of the hood and seal with duct tape. While securing the slack in the wire, lift the hood up to the wall and hang the hood on the mounting strip, taking care to properly align the duct connection(s) between the hood and the duct in the ceiling. Secure the hood to the mounting strip by installing the screws (previously removed from the strip in Step 10) into the pilot holes drilled in Step 12.

15) From inside the hood, using UL listed wire nuts, attach the "neutral" wire(s) to the white lead(s), the "hot" wire(s) to the black lead(s), and the ground wire(s) to the green lead(s) inside the motor box(es).

Warning: Do not operate hood without proper ground connection.

16) Plug the motor(s) into the hood and reinstall the blower motor(s) using the three retaining screws that were previously removed in Step 6.

17) Replace the blower housing(s) and the blower shield(s). Make sure that the damper(s) open and close smoothly.

18) Refer to the Owner Maintenance Guide Operating Instructions for proper hood operation. Test all blower and light functions to ensure they are operating properly.

VENTING

Vent-A-Hood®

ACCESSORIES

WALL LOUVER

MODEL	DIM
VP526	6" Round
VP527	7" Round
VP528	8" Round

WALL LOUVER

MODEL	DIM
VP554	10" Round

WALL LOUVER

MODEL	DIM
VP555	12" Round

RECTANGULAR WALL LOUVER

MODEL	DIM
VP538	6" x 8 1/2"
VP560	3 1/4" x 10"

LOW PROFILE ROOF JACK (MAXIMUM 4/12 PITCH)

MODEL	DIM
VP539	6" Round
VP540	7" Round
VP541	8" Round

LOW PROFILE ROOF JACK (MAXIMUM 4/12 PITCH)

MODEL	DIM
VP552	10" Round
VP553	12" Round

LOW PROFILE ROOF JACK (MINIMUM 4/12 PITCH)

MODEL	DIM
VP539-HP	6" Round
VP540-HP	7" Round
VP541-HP	8" Round

LOW PROFILE ROOF JACK (MINIMUM 4/12 PITCH)

MODEL	DIM
VP552-HP	10" Round
VP553-HP	12" Round

ADJUSTABLE ELBOW

VP513 - 8 1/2"
VP514 - 9 9/16"
VP515 - 10 5/8"

MODEL	DIM
VP513	6" Round
VP514	7" Round
VP515	8" Round

BACK/SIDE VENT ELBOW

MODEL	DIM
VP561	8" to 6" x 8 1/2"

3 1/4" x 10" BACK VENT ELBOW

MODEL	DIM
VP559	3 1/4" x 10"

3 1/4" x 10" TO 7" TRANSITION

MODEL	DIM
VP521	3 1/4" x 10" to 7"

MULTI-BLOWER TRANSITION

MODEL	DIM
VP562	6" & 8" to 10"
VP563	8" & 8" to 12"

M1 200 STANDARD TRANSITION

MODEL	DIM
VP566	21" x 8" to 10"

STANDARD ISLAND TRANSITION

MODEL	DIM
VP565	5" x 16" to 8"

CLUSTER BLOWER TRANSITION

MODEL	DIM
VP564	8" & 8" to 12"

OFFSET L & R TRANSITION FOR ISLAND BLOWERS

MODEL	DIM
VP542	Top Left
VP543	Top Right

SIDE VENT TRANSITION L & R FOR ISLAND BLOWERS

MODEL	DIM
VP544	Left Side
VP545	Right Side

OFFSET KIT - ROUND

MODEL	DIM
VP529	6" Rnd to 7" Rnd

OFFSET KIT - RECTANGULAR

MODEL	DIM
VP550	6" Rnd to 3 1/4" x 10"

"Y" TRANSITION

MODEL	DIM
VP517	8" & 8" to 12"
VP518	6" & 8" to 12"
VP551	6" & 8" to 10"

ROUND DUCT PIPE

MODEL	DIM
VP500	6" Round
VP501	7" Round
VP502	8" Round

3 1/4" RECTANGULAR DUCT PIPE

MODEL	DIM
VP504	3 1/4" x 10"
VP505	3 1/4" x 12"
VP506	3 1/4" x 16"

6" RECTANGULAR DUCT PIPE

MODEL	DIM
VP507	6" x 8 1/2"



Back Vent Applications (Page 1 of 4)

Hood Model/Hood Style	Back Vent Diagram	K250 (3-1/4" x 10")	B100 (6" Round)	B200 (8" Round)	B300 (8" Round & 6" Round)	B400 (Two 8" Round)
K-Series Under Cabinet Hood and Liner Insert	A	Standard	n/a	n/a	n/a	n/a
6" Under Cabinet (Excluding K-Series)	B	n/a	VP513	VP515 or VP561	VP513 & VP515 or VP561	2-VP515 or 2-VP561
9" Under Cabinet	B	n/a	VP513	VP515 or VP561	VP513 & VP515 or VP561	2-VP515 or 2-VP561
CWEH6-K	B	VP559	n/a	n/a	n/a	n/a
CWEH9	B	n/a	VP513	VP515 or VP561	VP513 & VP515 or VP561	2-VP515 or 2-VP561
CWLH9	B	n/a	VP513	VP515 or VP561	VP513 & VP515 or VP561	2-VP515 or 2-VP561
GTH-K	D	VP559	n/a	n/a	n/a	n/a
XLH12 with 10" x 10" Duct Cover	D	n/a	n/a	VP515 or VP561	n/a	n/a
ZTH	D	n/a	n/a	VP515 or VP561	VP513 & VP515 or VP561	n/a
18" Tall Wall Mount	B	n/a	VP513	VP515 or VP561	VP513 & VP515 or VP561	2-VP515 or 2-VP561
18" Tall Wall Mount - Special Deck at 9"	C	n/a	VP513	VP561*	VP513 & VP561*	2-VP561*
14" Tall Eurostyle Wall Mount (PD, SLD)	D	n/a	VP513	n/a	n/a	n/a
18" Tall Eurostyle Wall Mount (EP, NEP, SEP)	D	n/a	n/a	VP561*	n/a	n/a
18" Tall Eurostyle Wall Mount (EPT, NEPT, SEPT)	C	n/a	n/a	n/a	VP513 & VP515 or VP561	n/a
30" Tall Wall Mount	C	n/a	VP513	VP515 or VP561	VP513 & VP515 or VP561	2-VP515 or 2-VP561
CWH	B	n/a	VP513	VP515 or VP561	VP513 & VP515 or VP561	2-VP515 or 2-VP561
TILT-Out (TLH)	C	n/a	VP513	VP561*	n/a	n/a
JCH/A1 Designer Series	D	n/a	VP513	VP515 or VP561	VP513 & VP515 or VP561	2-VP515 or 2-VP561
JCH/B1 Designer Series	D	n/a	VP513	VP515 or VP561	VP513 & VP515 or VP561	2-VP515 or 2-VP561
JCH/C1 Designer Series	C	n/a	VP513	VP515 or VP561	VP513 & VP515 or VP561	2-VP515 or 2-VP561
JCH/C2 Designer Series	C	n/a	VP513	VP515 or VP561	VP513 & VP515 or VP561	2-VP515 or 2-VP561
JDH/C1 Designer Series	C	n/a	VP513	VP515 or VP561	VP513 & VP515 or VP561	2-VP515 or 2-VP561
JDH/C2 Designer Series	C	n/a	VP513	VP515 or VP561	VP513 & VP515 or VP561	2-VP515 or 2-VP561
JDH/D1 Designer Series	C	n/a	VP513	VP515 or VP561	VP513 & VP515 or VP561	2-VP515 or 2-VP561
12" Tall Magic Lung Wall Mount Liner Insert	B	n/a	VP513	VP515 or VP561	VP513 & VP515 or VP561	2-VP515 or 2-VP561

**Can also use VP515(s) with duct cover (elbow(s) will extend above the top of the hood.*

Note: This chart outlines the most common applications. Contact Vent-A-Hood or your distributor for more information.

SPECIFICATIONS SUBJECT TO CHANGE WITHOUT NOTICE (Rev. 04/11a)

Elbow and Transition Heights

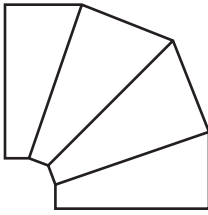

VP513: 6" Round - 8 1/2" Tall
When Fully Adjusted to 90 Degrees

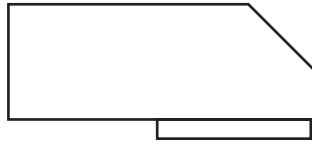

VP561: 8" Round to 6" x 8 1/2"
Rectangular - 7" Tall

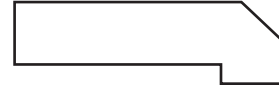

VP559: 3 1/4" x 10" - 4 1/4" Tall

VP515: 8" Round - 10 3/4" Tall
When Fully Adjusted to 90 Degrees

Diagram A - Direct Back Vent (Drawing Not To Scale)

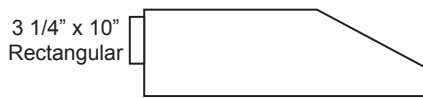

3 1/4" x 10"
Rectangular

Side View

Diagram B - Off the Top (Drawing Not To Scale)

VP513 - 6" Round VP561 - 8" Round
VP515 - 8" Round to 6" x 8 1/2" Rectangular

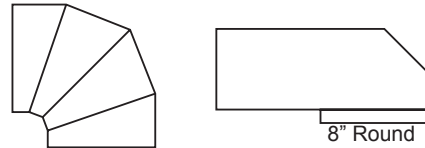

8" Round

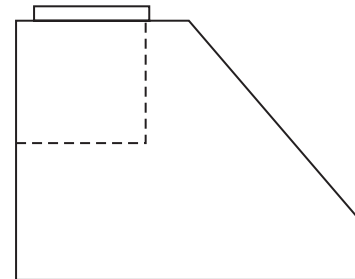

Side View

Diagram C - Within the Height of the Hood (Drawing Not To Scale)

VP513 - 6" Round VP561 - 8" Round
VP515 - 8" Round to 6" x 8 1/2" Rectangular

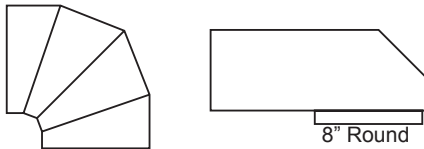

8" Round

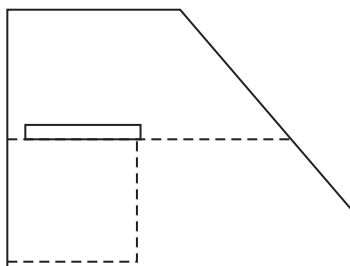

Side View

Diagram D - Off the Top Within the Duct Cover (Drawing Not To Scale)

VP513 - 6" Round VP561 - 8" Round
VP515 - 8" Round to 6" x 8 1/2" Rectangular

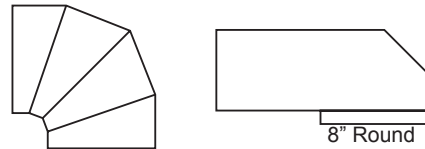

8" Round

VP559 - 3 1/4" x 10"
Rectangular

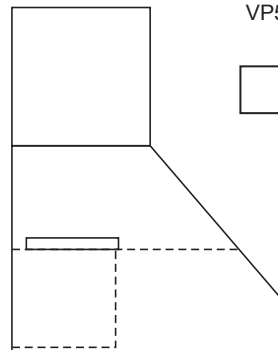

Side View

Back Vent Applications (Page 2 of 4)

NOTE: Excluding the SLH6-K, Under Cabinet Range Hood and the KHSLD Liner Insert, all Vent-A-Hood range hoods duct out the top and can be back-vented only by use of transitions and/or elbows.

Transition Heights

VP559: 3 1/4" x 10" Rectangular - 4 1/4" Tall

VP513: 6" Round - 8 1/2" Tall When Adjusted To 90 Degrees

VP515: 8" Round - 10 3/4" Tall When Adjusted To 90 Degrees

VP561: 8" Round To 6" x 8 1/2" Rectangular - 7" Tall

VP559 - 3 1/4" x 10"
Rectangular

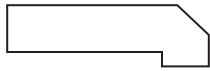

VP513 - 6" Round
VP515 - 8" Round

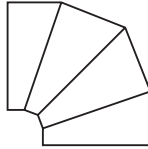

VP561 - 8" Round
to 6" x 8 1/2" Rectangular

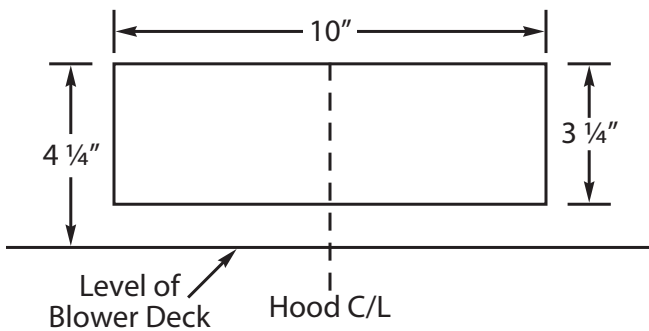

**K Series With VP559
Installed (Back View)**

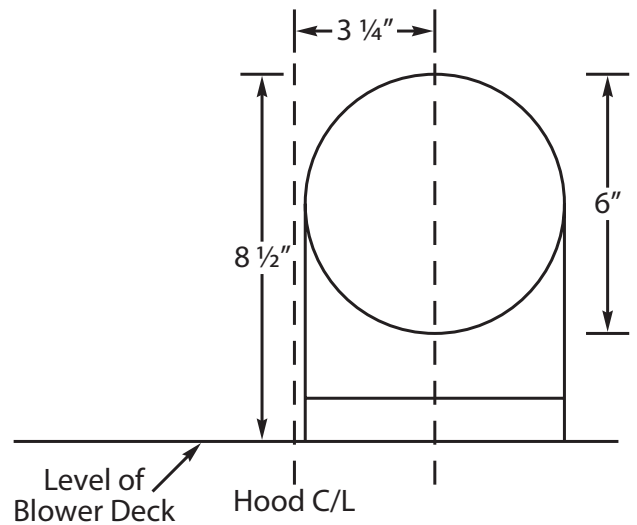

**B100 Blower Outlet With VP513
Installed (Back View)**

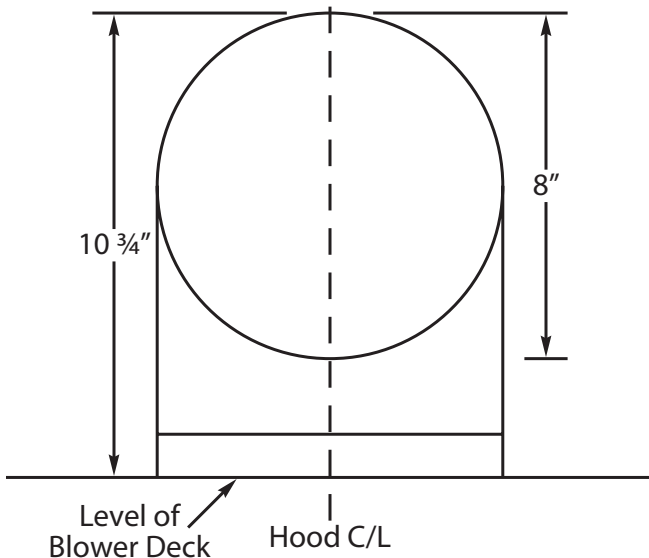

**B200 Blower Outlet With VP515
Installed (Back View)**

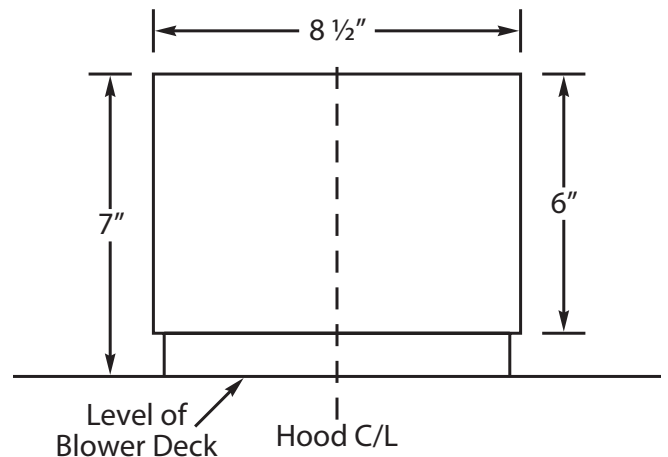

**B200 Blower Outlet With VP561
Installed (Back View)**

Back Vent Applications (Page 3 of 4)

NOTE: Excluding the SLH6-K, Under Cabinet Range Hood and the KHSLD Liner Insert, all Vent-A-Hood range hoods duct out the top and can be back-vented only by use of transitions and/or elbows.

Transition Heights

VP513: 6" Round - 8 1/2" Tall When Adjusted To 90 Degrees

VP515: 8" Round - 10 3/4" Tall When Adjusted To 90 Degrees

VP561: 8" Round To 6" x 8 1/2" Rectangular - 7" Tall

VP513 - 6" Round
VP515 - 8" Round

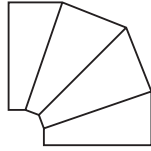

VP561 - 8" Round
to 6" x 8 1/2" Rectangular

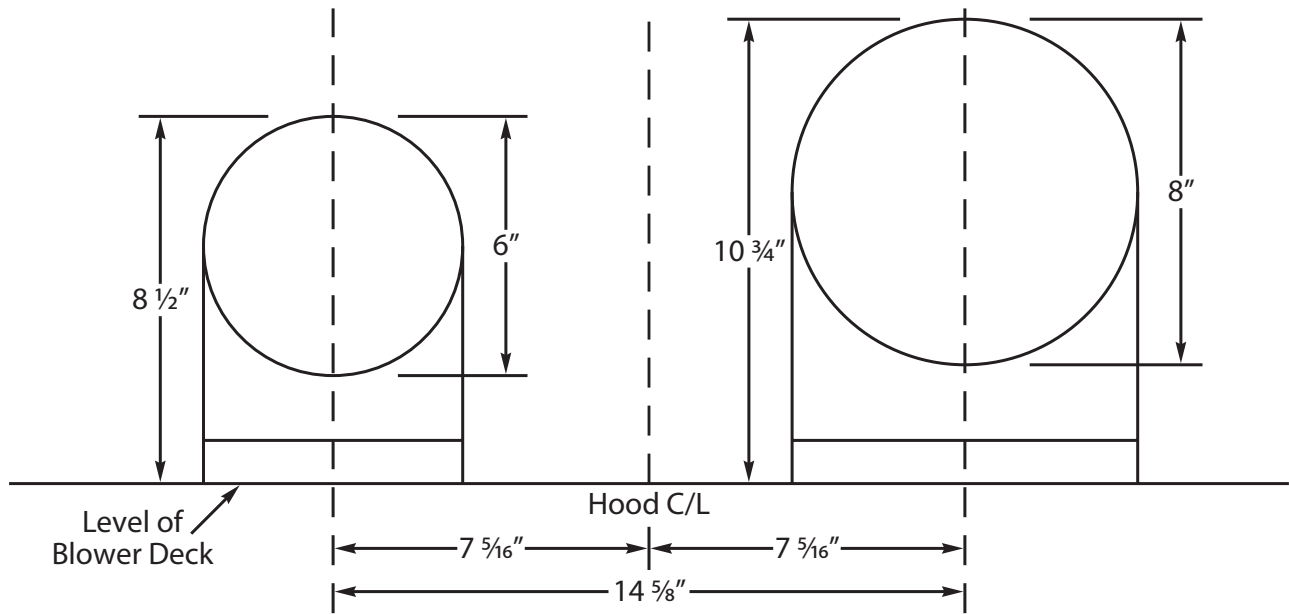

**B300 Blower Outlets With VP513
And VP515 Installed (Back View)**

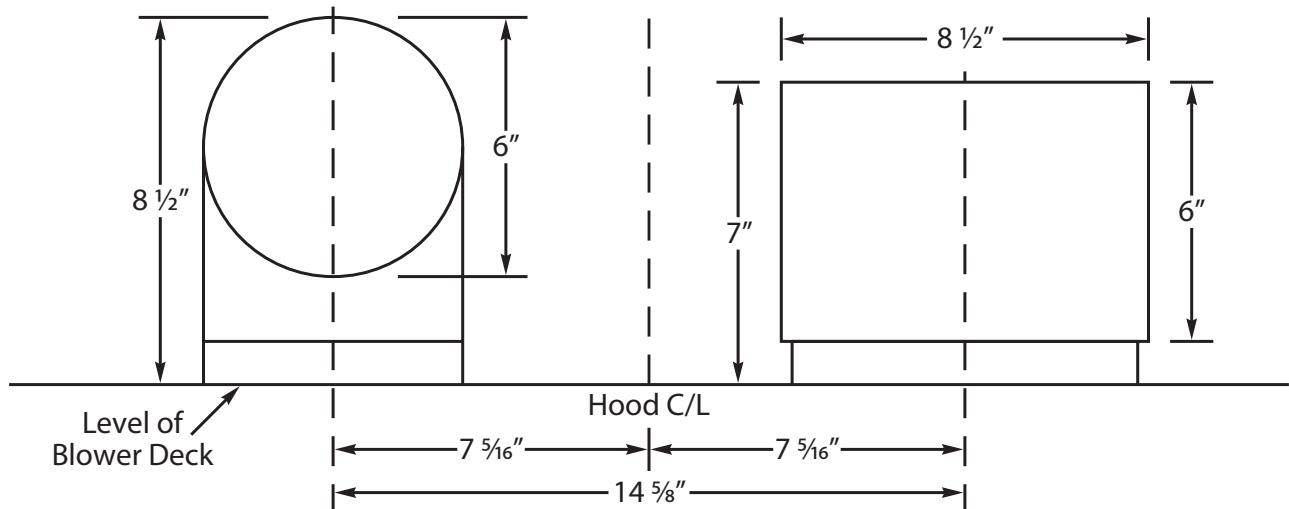

**B300 Blower Outlets With VP513
And VP561 Installed (Back View)**

Back Vent Applications (Page 4 of 4)

NOTE: Excluding the SLH6-K, Under Cabinet Range Hood and the KHSLD Liner Insert, all Vent-A-Hood range hoods duct out the top and can be back-vented only by use of transitions and/or elbows.

Transition Heights

VP513: 6" Round - 8 1/2" Tall When Adjusted To 90 Degrees

VP515: 8" Round - 10 3/4" Tall When Adjusted To 90 Degrees

VP561: 8" Round To 6" x 8 1/2" Rectangular - 7" Tall

VP513 - 6" Round
VP515 - 8" Round

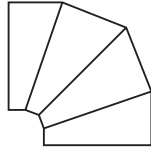

VP561 - 8" Round
to 6" x 8 1/2" Rectangular

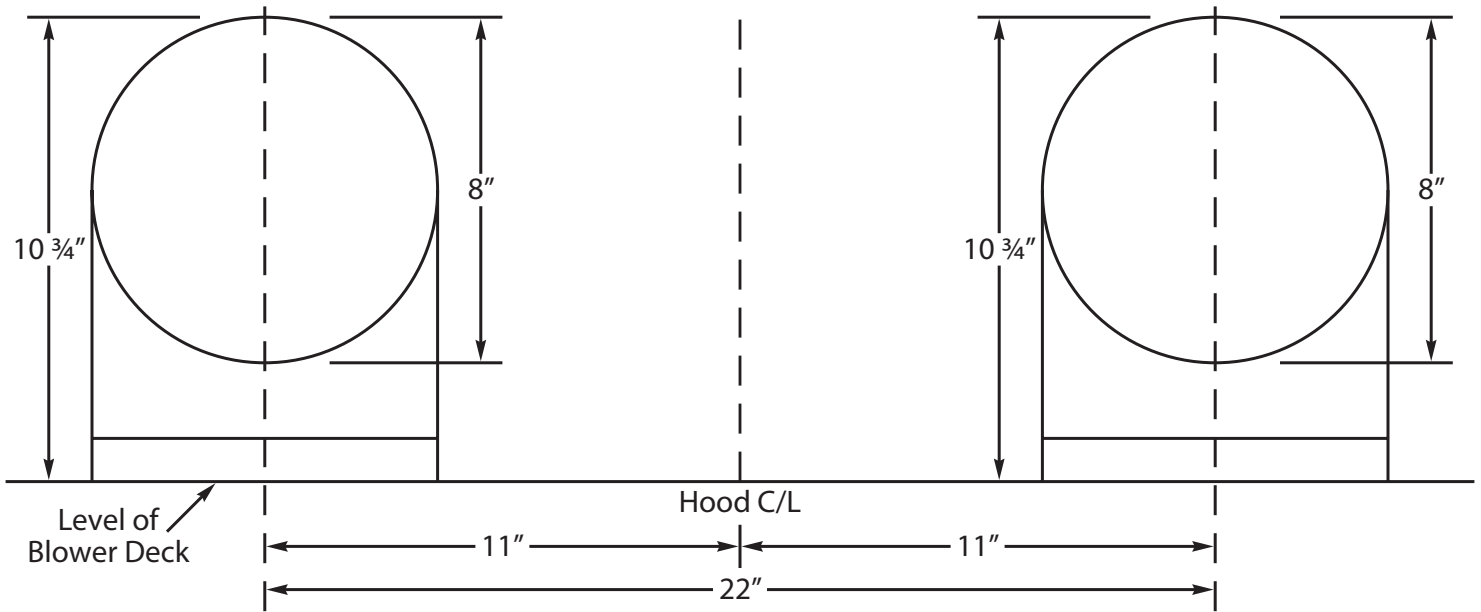

**B400 Blower Outlets With 2 VP515s
Installed (Back View)**

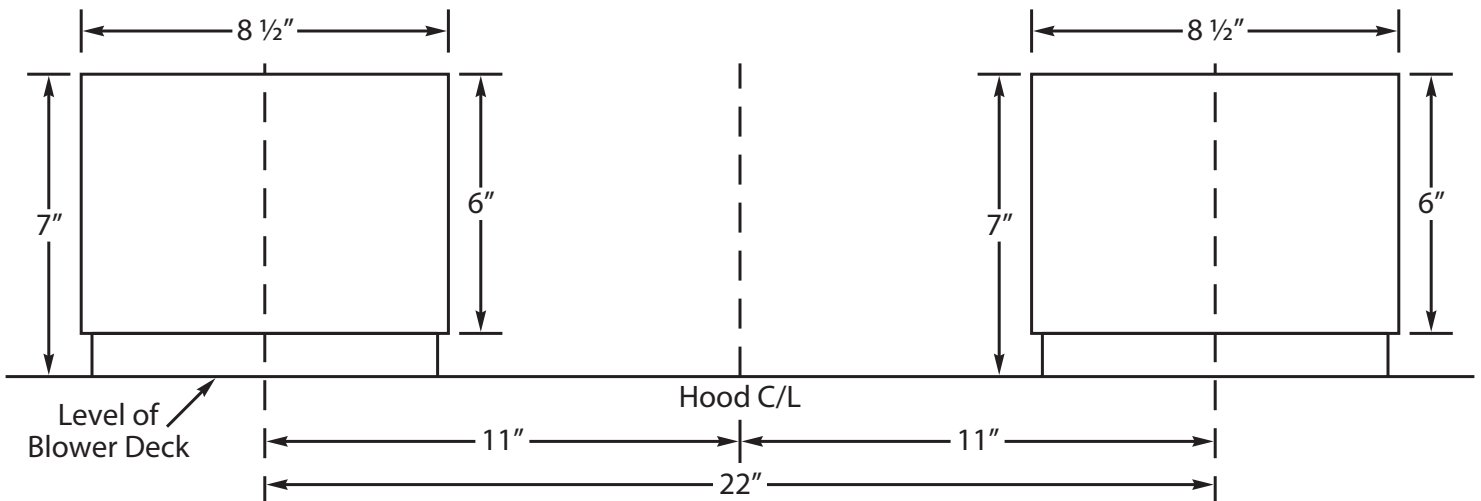

**B400 Blower Outlets With 2 VP561s
Installed (Back View)**

VENT-A-HOOD VENTING ACCESSORIES

WALL LOUVER

MODEL	DESCRIPTION	PRICE
VP526	6" Round	
VP527	7" Round	
VP528	8" Round	

WALL LOUVER

MODEL	DESCRIPTION	PRICE
VP554	10" Round	

WALL LOUVER

MODEL	DESCRIPTION	PRICE
VP555	12" Round	

RECTANGULAR WALL LOUVER

MODEL	DESCRIPTION	PRICE
VP538	6" x 8-1/2"	
VP560	3-1/4" x 10"	

LOW PROFILE ROOF JACK (MAXIMUM 4/12 PITCH)

MODEL	DESCRIPTION	PRICE
VP539	6" Round	
VP540	7" Round	
VP541	8" Round	

LOW PROFILE ROOF JACK (MAXIMUM 4/12 PITCH)

MODEL	DESCRIPTION	PRICE
VP552	10" Round	
VP553	12" Round	

LOW PROFILE ROOF JACK (MINIMUM 4/12 PITCH)

MODEL	DESCRIPTION	PRICE
VP539-HP	6" Round	
VP540-HP	7" Round	
VP541-HP	8" Round	

LOW PROFILE ROOF JACK (MINIMUM 4/12 PITCH)

MODEL	DESCRIPTION	PRICE
VP552-HP	10" Round	
VP553-HP	12" Round	

ADJUSTABLE ELBOW

VP513 - 8 1/2"
VP514 - 9 3/8"
VP515 - 10 3/8"

MODEL	DESCRIPTION	PRICE
VP513	6" Round	
VP514	7" Round	
VP515	8" Round	

BACK/SIDE VENT ELBOW

MODEL	DESCRIPTION	PRICE
VP561	8" to 6" x 8-1/2"	

3 1/4" x 10" BACK VENT ELBOW

MODEL	DESCRIPTION	PRICE
VP559	3-1/4" x 10"	

3 1/4" x 10" TO 7" TRANSITION

MODEL	DESCRIPTION	PRICE
VP521	3-1/4" x 10 to 7"	

MULTI-BLOWER TRANSITION

VP562 - 17 1/2"
VP563 - 16 1/2"
VP562 - 23 1/4"
VP563 - 30 1/2"

MODEL	DESCRIPTION	PRICE
VP562	6" & 8" to 10"	
VP563	8" & 8" to 12"	

M1200 STANDARD TRANSITION

MODEL	DESCRIPTION	PRICE
VP566	M1200 Transition	

STANDARD ISLAND TRANSITION

MODEL	DESCRIPTION	PRICE
VP565	5" x 16" to 8" Rnd	

CLUSTER BLOWER TRANSITION

MODEL	DESCRIPTION	PRICE
VP564	8" & 8" to 12"	

OFFSET L & R TRANSITION FOR ISLAND BLOWERS

MODEL	DESCRIPTION	PRICE
VP542	Top Left	
VP543	Top Right	

SIDE VENT TRANSITION L & R FOR ISLAND BLOWERS

MODEL	DESCRIPTION	PRICE
VP544	Side Left	
VP545	Side Right	

OFFSET KIT - ROUND

MODEL	DESCRIPTION	PRICE
VP529	6" Rnd to 7" Rnd	

OFFSET KIT - RECTANGULAR

MODEL	DESCRIPTION	PRICE
VP550	6" to 3-1/4" x 10"	

"Y" TRANSITION

MODEL	DESCRIPTION	PRICE
VP517	8" & 8" to 12"	
VP518	6" & 8" to 12"	
VP551	6" & 8" to 10"	

ROUND DUCT PIPE

MODEL	DESCRIPTION	PRICE
VP500	6" Round	
VP501	7" Round	
VP502	8" Round	

3 1/4" RECTANGULAR DUCT PIPE

MODEL	DESCRIPTION	PRICE
VP504	3-1/4" x 10"	
VP505	3-1/4" x 12"	
VP506	3-1/4" x 16"	

6" RECTANGULAR DUCT PIPE

MODEL	DESCRIPTION	PRICE
VP507	6" x 8-1/2"	

PARTS FOR VENT-A-HOOD PRODUCTS

<u>MOTORS</u>		
<u>PART NO.</u>	<u>DESCRIPTION</u>	<u>PRICE</u>
P1301-1	SINGLE SPEED WHITE MOTOR (CW)	
P1301-2	TWO SPEED WHITE MOTOR (CW)	
P1302-1	BLACK MOTOR (CCW)	
P1315	K SERIES MOTOR	
P1900	ADAPTER (AMP PLUG/TWO PRONG PLUG)	

<u>BLOWER WHEELS</u>		
<u>PART NO.</u>	<u>DESCRIPTION</u>	<u>PRICE</u>
P1305	WHITE BLOWER WHEEL (CW)	
P1306	BLACK BLOWER WHEEL (CCW)	
P1307	K SERIES BLOWER WHEEL	

<u>BLOWER HOUSINGS</u>		
<u>PART NO.</u>	<u>DESCRIPTION</u>	<u>PRICE</u>
<i>SPECIFY HOOD COLOR</i>		
P1029	B100/T200 BLOWER HSG w/DAMPER	
P1029E	B100/T200 EZ CLEAN HSG w/DAMPER	
P1028	B200/T400 BLOWER HSG w/DAMPERS	
P1028E	B200/T400 EZ CLEAN HSG w/DAMPERS	
P1030	T200 REVERSE BLOWER HSG w/DAMPER	
P1030E	T200 REVERSE EZ CLEAN HSG w/DAMPER	
P1021	K SERIES BLOWER COVER (PAN)	

<u>BLOWER SHIELDS</u>		
<u>PART NO.</u>	<u>DESCRIPTION</u>	<u>PRICE</u>
P1025	B100/T200 SHIELD (ENAMEL)	
P1025E	B100/T200 EZ CLEAN SHIELD (ENAMEL)	
P1027	B100/T200 SHIELD (STAINLESS)	
P1027E	B100/T200 EZ CLEAN SHIELD (STAINLESS)	
P1024	B200/T400 SHIELD (ENAMEL)	
P1024E	B200/T400 EZ CLEAN SHIELD (ENAMEL)	
P1026	B200/T400 SHIELD (STAINLESS)	
P1026E	B200/T400 EZ CLEAN SHIELD (STAINLESS)	
P1610P	NICKEL SHIELD SCREW	

<u>SWITCHES AND CONTROLS</u>		
<u>PART NO.</u>	<u>DESCRIPTION</u>	<u>PRICE</u>
P1430	SWITCH FOR SINGLE SPEED WHITE MOTOR	
P1431	SWITCH FOR SINGLE SPEED BLACK MOTOR	
P1432	SWITCH FOR FLUORESCENT LIGHT	
P1433	SWITCH FOR TWO SPEED WHITE MOTOR	
P1434	SWITCH FOR HALOGEN LIGHTS	
P1409	MOMENTARY SWITCH (TILT/TLH HOODS)	
P1418	DIMMER SWITCH (CAN LIGHTS)	
P1419	ROTARY SWITCH (HEAT LIGHTS)	
P1422	KNOB FOR ROTARY SWITCH (SET SCREW)	
P1425	REMOTE BLOWER SPEED CONTROL (HOOD)	

<u>M LINE COMPONENTS</u>		
<u>PART NO.</u>	<u>DESCRIPTION</u>	<u>PRICE</u>
P1440	M LINE BLOWER SWITCH	
P1445	M LINE BLOWER SWITCH KNOB	
P1450	M LINE LIGHT SWITCH	
P1455	M LINE LIGHT SWITCH KNOB	
P1456	M600 WIRING HARNESS	
P1457	M1200 WIRING HARNESS	

<u>LIGHT BULBS</u>		
<u>PART NO.</u>	<u>DESCRIPTION</u>	<u>PRICE</u>
P1110	GU10 HALOGEN BULB, 50 WATT	
P1120	F15/T8 FLUORESCENT BULB, 15 WATT	
P1130	PAR20 HALOGEN BULB, 50 WATT	

<u>LIGHT FIXTURE COMPONENTS</u>		
<u>PART NO.</u>	<u>DESCRIPTION</u>	<u>PRICE</u>
P1101	SP2 BALLAST (NEWER HOODS)	
P1103	LEFT LAMPHOLDER	
P1104	RIGHT LAMPHOLDER	
P1105	FS-2 STARTER	
P1106	STARTER SOCKET	
P1122	HEAT LAMP SOCKET	
P1123	PAR20 HALOGEN LAMP SOCKET	
P1124	GU10 HALOGEN LAMP SOCKET	

<u>COMPLETE FLUORESCENT LIGHT FIXTURES</u>		
<u>PART NO.</u>	<u>DESCRIPTION</u>	<u>PRICE</u>
<i>INCLUDES 18" FLUORESCENT BULB (P1120)</i>		
<i>SPECIFY MODEL, COLOR, AND SIZE OF HOOD</i>		
<i>NOT AVAILABLE IN STAINLESS STEEL, USE GUNSMOKE</i>		
P1016	3" LIGHT BOX (WALL MOUNT & ISLAND)	
P1018	2" LIGHT BOX (UNDER CABINET)	
PxxxB	FIXTURE WITH BACK, ADD	
P1127	FLUORESCENT LIGHT DIFFUSER	

<u>REPLACEMENT FILTERS</u>		
<u>PART NO.</u>	<u>DESCRIPTION</u>	<u>PRICE</u>
P1501	CV FILTER (11-1/2" DIA. X 4-1/2" T)	
P1502A	MESH (16" x 20" x 2")	
P1502B	MESH (10" x 20" x 2")	
P1506	SS BAFFLE (16" x 20" x 1-1/2")	
P1506A	SS BAFFLE (10" x 20" x 1-1/2")	
P1530	M LINE BAFFLE FILTER	

<u>BACK DRAFT DAMPERS</u>		
<u>PART NO.</u>	<u>DESCRIPTION</u>	<u>PRICE</u>
P1031	NYLON POLYMER DAMPER	
P1040	B100/T200 METAL DAMPER	
P1041	B200 METAL DAMPER	
P1042	K SERIES DAMPER	

<u>REMOTE BLOWER COMPONENTS</u>		
<u>PART NO.</u>	<u>DESCRIPTION</u>	<u>PRICE</u>
P1425	REMOTE BLOWER SPEED CONTROL (HOOD)	
P1510	RM1000 BLOWER WHEEL	
P1515	RM1000 MOTOR	
P1520	RM1500 BLOWER WHEEL	
P1525	RM1500 MOTOR	

<u>OTHER MISCELLANEOUS ITEMS</u>		
<u>PART NO.</u>	<u>DESCRIPTION</u>	<u>PRICE</u>
P1039	FLAP STAY FOR TILT/TLH HOODS	
AW101	T-HANDLE, 1/8" ALLEN WRENCH	
AW102	STANDARD, 1/8" ALLEN WRENCH	
P1424	SENSASOURCE THERMOSTAT ASSY	
SS KIT	STAINLESS STEEL SCRATCH REPAIR KIT	
SS64	STAINLESS STEEL MAGIC (CAN)	
CP101	RED BEAR@ COPPER POLISH	
P1316	3-1/4" x 10" COLLAR FOR K SERIES	
P1317	BACK PLATE FOR K SERIES	