

# Use, Care, and Installation Guide

## Gust

- AK7100AS
- AK7136AS
- AK7100AS-BF
- AK7136AS-BF
- AK7100AS290
- AK7136AS290

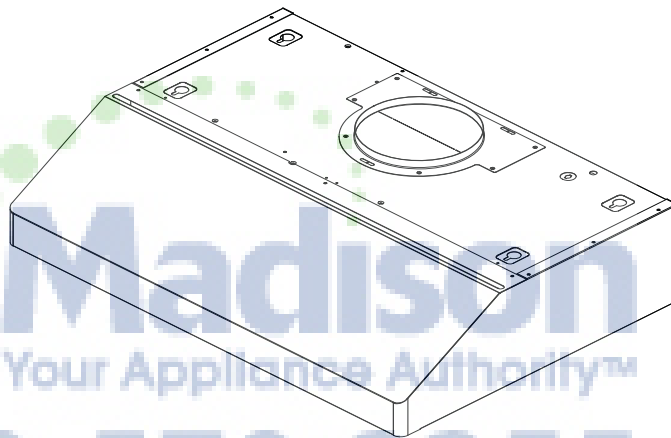

**AjMadison**  
Your Appliance Authority™  
800-570-3355



C US

Model number: \_\_\_\_\_

Serial Number: \_\_\_\_\_

Date of Purchase: \_\_\_\_\_

Sales Dealer: \_\_\_\_\_



**SAFETY NOTICE** ..... 2-3  
**LIST OF MATERIALS** ..... 4

**INSTALLATION**

Ductwork Calculation Sheet ..... 5  
Mounting Height & Clearance ..... 6  
Ducting Options ..... 7  
Specifications ..... 8  
Preparing Electrical ..... 9  
Preparing Ducting Location ..... 10  
Recirculating ..... 11  
Optional Utensil Bar ..... 12  
Mounting the Range Hood ..... 13

**CONTROLS**

Slide Controls ..... 14

**MAINTENANCE**

Cleaning and Filter Removal ..... 15  
Lights ..... 16

**TROUBLESHOOTING**

..... 17

**WIRING DIAGRAMS**

..... 18

**LIST OF PARTS AND ACCESSORIES** ..... 19

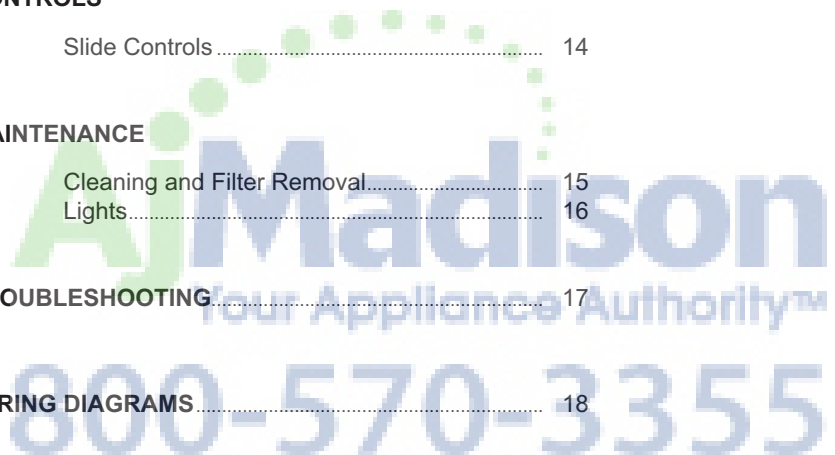

**Important Safety Notice**

**WARNING**

TO REDUCE THE RISK OF FIRE OR ELECTRIC SHOCK, DO NOT USE THIS FAN WITH ANY SOLID-STATE CONTROL DEVICE.

**WARNING**

TO REDUCE THE RISK OF FIRE ELECTRIC SHOCK, OR INJURY TO PERSONS, OBSERVE THE FOLLOWING:

- a. Use this unit only in the manner intended by the manufacturer, if you have questions, contact the manufacturer.
- b. Before servicing or cleaning unit, switch power off at service panel and lock panel to prevent power from being switched on accidentally. When the service disconnecting means cannot be locked, securely fasten a prominent warning device, such as a tag, to the service panel.

**CAUTION**

For general ventilating use only. Do not use to exhaust hazardous or explosive materials and vapors. Take care when using cleaning agents or detergents. Suitable for use in household cooking area.

**WARNING**

TO REDUCE THE RISK OF RANGE TOP GREASE FIRE:

- a. Never leave surface units unattended at high settings. Boilovers cause smoking and greasy spillovers that may ignite. Heat oils slowly on low or medium settings.
- b. Always turn hood ON when cooking at high heat or when flaming food
- c. Clean ventilating fans frequently. Grease should not be allowed to accumulate on fan or filter.
- d. Use proper pan size. Always use cookware appropriate for the size of the surface element.
- e. Keep fan, filters and grease laden surfaces clean.
- f. Use high setting on hood only when necessary.
- g. Don't leave hood unattended when cooking.
- h. Always use cookware and utensils appropriate for the type of and amount of food being prepared.

**WARNING**

TO REDUCE THE RISK OF INJURY TO PERSONS IN THE EVENT OF A RANGE TOP FIRE, OBSERVE THE FOLLOWING:

- a. SMOTHER FLAMES with a close-fitting lid, cookie sheet, or metal tray, then turn off the burner. BE CAREFUL TO PREVENT BURNS. If the flames do not go out immediately, EVACUATE AND CALL THE FIRE DEPARTMENT.
- b. NEVER PICK UP A FLAMING PAN – You may be burned.
- c. DO NOT USE WATER, including wet dishcloths or towels – a violent steam explosion will result.
- d. Use an extinguisher ONLY if:
  - 1. You know you have a Class ABC extinguisher, and you already know how to operate it.
  - 2. The fire is small and contained in the area where it started.
  - 3. The fire department is being called.
  - 4. You can fight the fire with your back to an exit

**WARNING**

TO REDUCE THE RISK OF FIRE, ELECTRIC SHOCK OR INJURY TO PERSONS, OBSERVE THE FOLLOWING:

- a. Installation work and electrical wiring must be done by qualified person(s) in accordance with all applicable codes and standards. Including fire-rated construction.
- b. Sufficient air is needed for power combustion and exhausting of gases through the flue (chimney) of fuel burning equipment to prevent back-drafting. Follow the heating equipment manufacturer's guideline and safety standards such as those published by the National Fire Protection Association (NFPA) and the American Society for Heating, Refrigeration and Air Conditioning Engineers (ASHRAE) and the local code authorities.
- c. When cutting or drilling into wall or ceiling, do not damage electrical wiring and other hidden utilities.
- d. Ducted fans must always vent to the outdoors.
- e. NEVER place a switch where it can be reached from a tub or shower.
- f. Make sure the power is off before installing, wiring or maintaining.

**WARNING**

TO REDUCE THE RISK OF FIRE, USE ONLY METAL DUCTWORK.

**CAUTION**

To reduce risk of fire and to properly exhaust air outside - Do not vent exhaust air into spaces within walls, ceilings, attics, crawl spaces or garages.

**OPERATION**

Always leave safety grilles and filters in place. Without these components, operating blowers could catch onto hair, fingers and loose clothing.

The manufacturer declines all responsibility in the event of failure to observe the instructions given here for installation, maintenance and suitable use of the product. The manufacturer further declines all responsibility for injury due to negligence and the warranty of the unit automatically expires due to improper maintenance.

**\*NOTE: Please check [www.zephyronline.com](http://www.zephyronline.com) for revisions before doing any custom work.**

**ELECTRICAL REQUIREMENTS**

**Important:**

Observe all governing codes and ordinances.

It is the customer's responsibility:

- To contact a qualified electrical installer.
- To assure that the electrical installation is adequate and in conformance with National Electrical Code, ANSI/NFPA 70 latest edition\* or CSA standards C22.1-94, Canadian Electrical Code, Part 1 and C22.2 No.0-M91 - latest edition\*\* and all local codes and ordinances.

If codes permit and a separate ground wire is used, it is recommended that a qualified electrician determine that the ground path is adequate.

Do not ground to a gas pipe.

Check with a qualified electrician if you are not sure the range hood is properly grounded.

Do not have a fuse in the neutral or ground circuit.

\*National Fire Protection Association Batterymarch Park, Quincy, Massachusetts 02269

\*\* CSA International 8501 East Pleasant Valley Road, Cleveland, Ohio 44131-5575

This appliance requires a 120V 60Hz electrical supply and connected to an individual properly grounded branch circuit protected by a 15 or 20 ampere circuit breaker or time delay fuse. Wiring must be 2 wire with ground. Please also refer to Electrical Diagram on product.

A cable locking connector (not supplied) might also be required by local codes. Check with local requirements, purchase and install appropriate connector if necessary.

AK7100AS / AK7136AS - 207 Watts, 1.7 Amps

AK7100AS290 / AK7136AS290 - 186 Watts, 1.55 Amps

# List of Materials

**MODELS:** AK7100AS (290) & AK7136AS (290)

## PARTS SUPPLIED

- 1 - Hood
- 2 - Aluminum mesh or baffle filters
- 2 - Halogen light bulbs (*pre-installed*)
- 1 - 7" round transition collar
- 1 - 3 1/4" x 10" rectangular collar with damper
- 1 - Utensil bar
- 1 - Hardware package

## HARDWARE PACKAGE CONTENTS



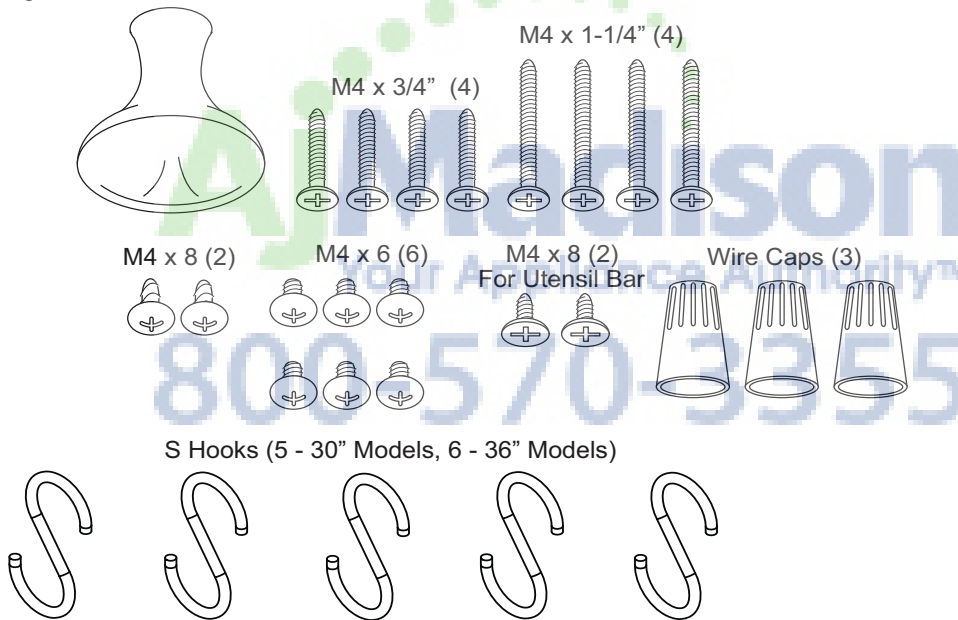





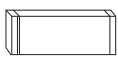

Suction Cup (1)  
For Light Bulb Installation and Removal

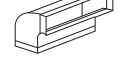











## PARTS NOT SUPPLIED

- Ducting, conduit and all installation tools
- Cable lock (*if required by local codes*)
- Recirculating kit

# Installation – Ductwork Calculation Sheet

Duct pieces		Equivalent number length x used =	Total
	3-1/4" x 10" Rect., straight	1 Ft. x ( ) =	Ft.
	7" Round, straight	1 Ft. x ( ) =	Ft.
	8" Round, straight	1 Ft. x ( ) =	Ft.
	3-1/4" x 10" Rect. 90° elbow	15 Ft. x ( ) =	Ft.
	3-1/4" x 10" Rect. 45° elbow	9 Ft. x ( ) =	Ft.
	3-1/4" x 10" Rect. 90° flat elbow	24 Ft. x ( ) =	Ft.
	3-1/4" x 10" Rect. wall cap with damper	30 Ft. x ( ) =	Ft.
	3-1/4" x 10" Rect. to 6" round transition	5 Ft. x ( ) =	Ft.
	3-1/4" x 10" Rect. to 6" round transition 90° elbow	20 Ft. x ( ) =	Ft.
	7" Round, 90° elbow	15 Ft. x ( ) =	Ft.
	7" Round, 45° elbow	9 Ft. x ( ) =	Ft.
Subtotal column 1 =			Ft.

Duct pieces		Equivalent number length x used =	Total
	6" - 8" Round wall cap with damper	30 Ft. x ( ) =	Ft.
	6" - 8" Round, roof cap	30 Ft. x ( ) =	Ft.
	6" round to 3-1/4" x 10" rect. transition	1 Ft. x ( ) =	Ft.
	6" round to 3-1/4" x 10" rect. transition 90° elbow	16 Ft. x ( ) =	Ft.
	7" or 8" Round, 90° elbow	15 Ft. x ( ) =	Ft.
	7" or 8" Round, 45° elbow	9 Ft. x ( ) =	Ft.
	7" or 8" Round wall cap with damper	30 Ft. x ( ) =	Ft.
	7" or 8" Round, roof cap	30 Ft. x ( ) =	Ft.
	7" round to 3 1/4" x 10" rect. transition	8 Ft. x ( ) =	Ft.
	7" round to 3-1/4" x 10" rect. transition 90° elbow	23 Ft. x ( ) =	Ft.
Subtotal column 2 =			Ft.
Subtotal column 1 =			Ft.
Total ductwork =			Ft.

**Maximum Duct Length:** For satisfactory air movement, the total duct length should not exceed 100 equivalent feet.

# Installation – Mounting Height & Clearance

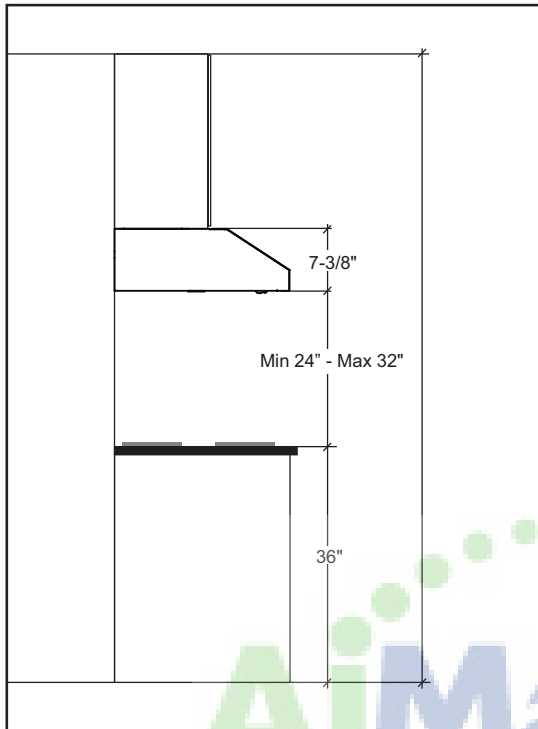

Minimum mounting height between range top to hood bottom should be no less than 24".

Maximum mounting height should be no higher than 32".

It is important to install the hood at the proper mounting height. Hoods mounted too low could result in heat damage and fire hazard; while hoods mounted too high will be hard to reach and will lose its performance and efficiency.

If available, also refer range manufacturer's height clearance requirements and recommended hood mounting height above range.

### Vertical Ducting:

7" round minimum or  
3-1/4" x 10" rectangular minimum

### Horizontal Ducting:

3-1/4"x10" rectangular minimum

## DUCTING

A minimum of 7" round or 3-1/4" x 10" rectangular duct must be used to maintain maximum air flow efficiency.

Always use rigid type metal ducts only. Flexible ducts could restrict air flow by up to 50%.

Also use calculation (on page 5) to compute total available duct run when using elbows, transitions and caps.

ALWAYS, when possible, reduce the number or transitions and turns. If long duct run is required, increase duct size from 7" to 8".

If turns or transitions are required; install as far away from hood duct output and as far apart, between the two as possible.

### DAMAGE-SHIPMENT / INSTALLATION:

- Please fully inspect unit for damage before installation.
- If the unit is damaged in shipment, return the unit to the store in which it was bought for repair or replacement.
- If the unit is damaged by the customer, repair or replacement is the responsibility of the customer.
- If the unit is damaged by the installer (if other than the customer), repair or replacement must be made by arrangement between customer and installer.



**WARNING FIRE HAZARD**

NEVER exhaust air or terminate duct work into spaces between walls, crawl spaces, ceiling, attics or garages. All exhaust must be ducted to the outside.

Use metal ductwork only.

Fasten all connections with sheet metal screws and tape all joints with certified Silver Tape or Duct Tape.

**Some Ducting Options**

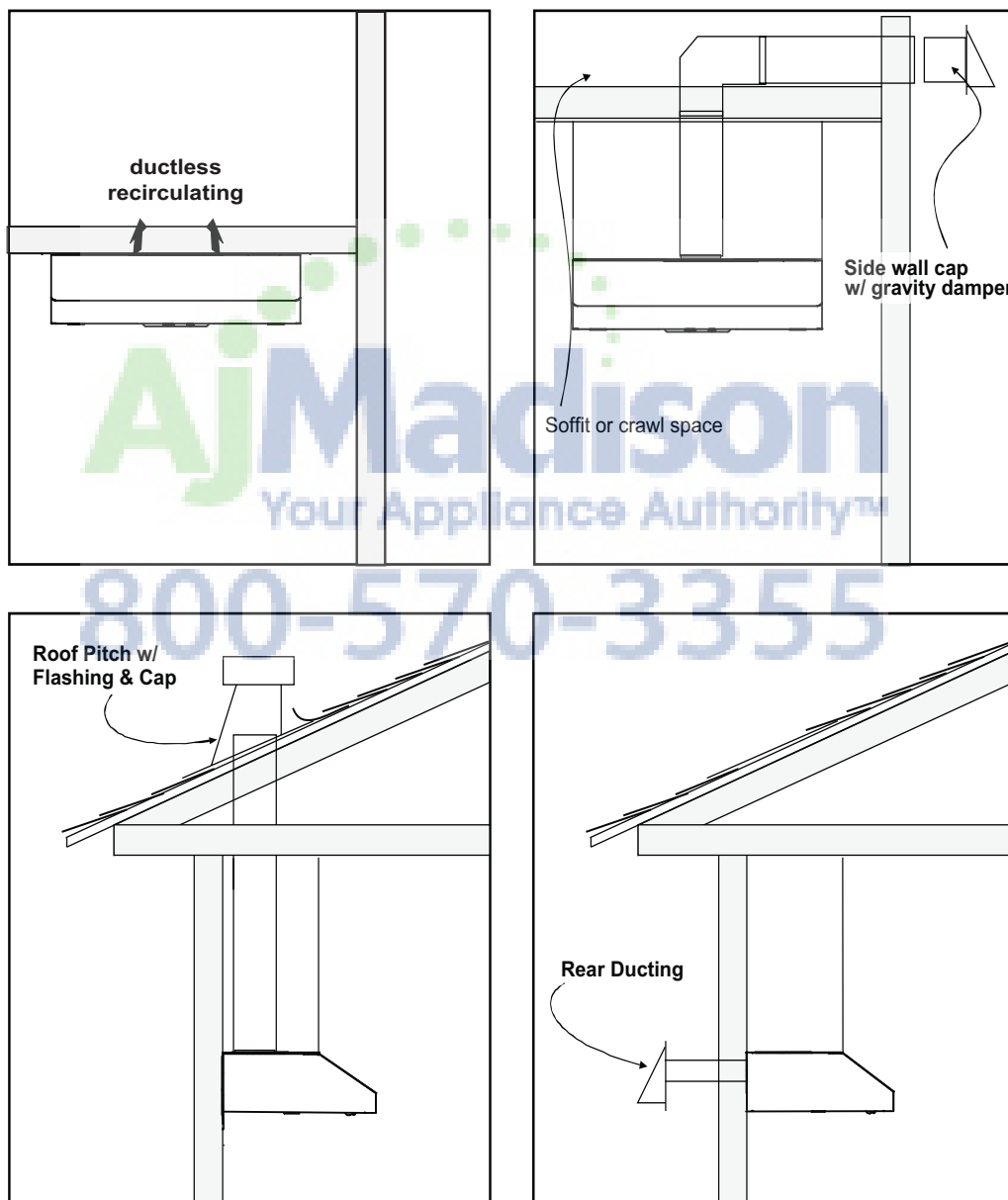

Installation – Specifications

Top

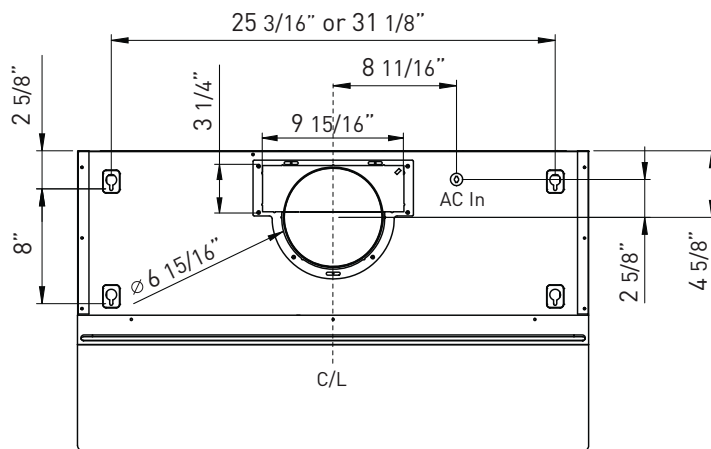

Back

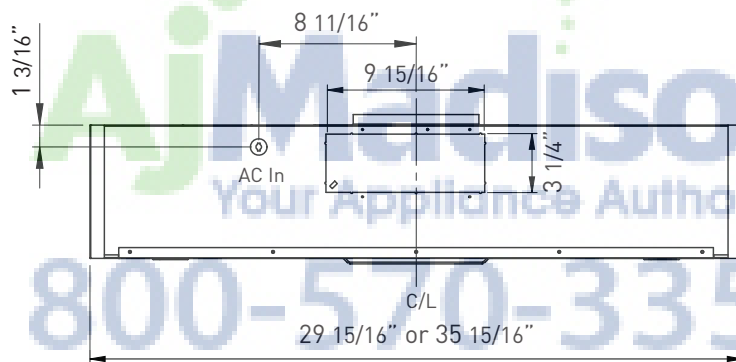

Side

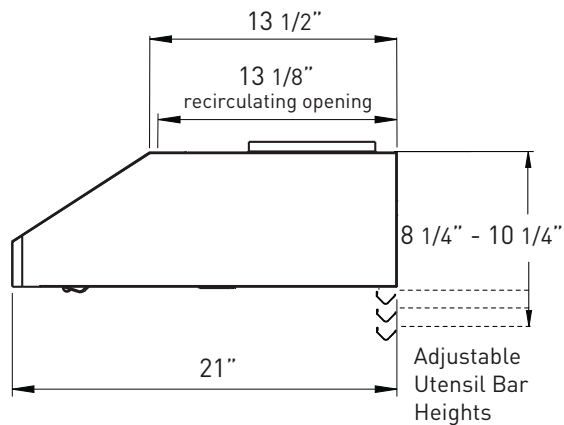

**ELECTRICAL  
WARNING**

All Electrical work must be performed by qualified electrician or person with similar technical knowledge and background.

For personal safety, remove house fuse or open circuit breaker before beginning installation. Do not use extension cord or adapter plug with this appliance.

Follow national electrical codes or prevailing local codes and ordinances.

**Electrical Supply:**

This appliance requires a 120V 60Hz electrical supply, and connected to an individual, properly grounded branch circuit, protected by a 15 or 20 ampere circuit breaker or time delay fuse. Wiring must be 2 wire w/ ground. Please refer to Electrical Diagram labeled on product.

**Cable Lock:**

A cable locking connector (not supplied) might also be required by local codes. Check with local requirements and codes, purchase and install appropriate connector if necessary.

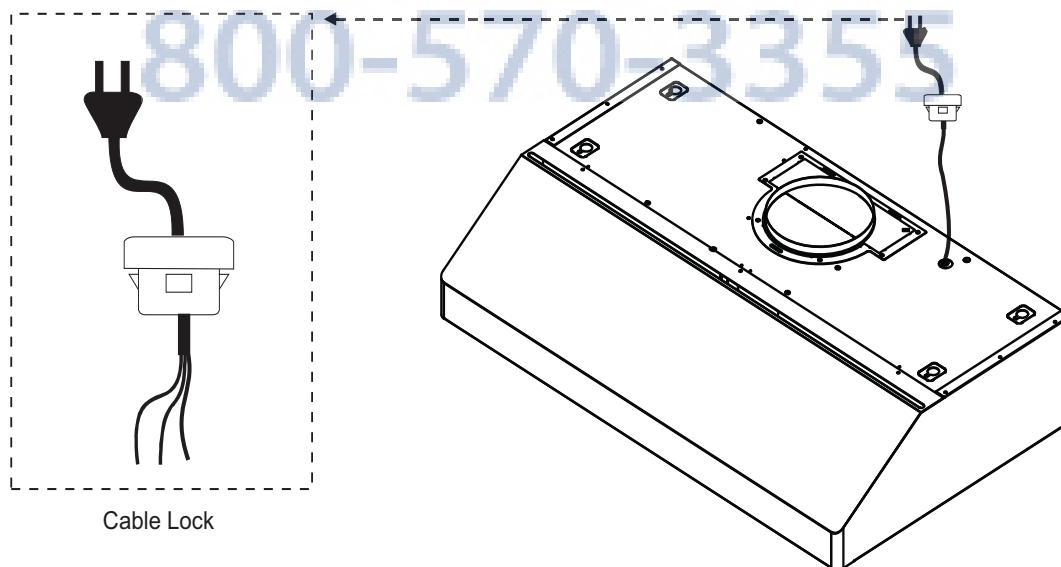

# Installation – Preparing Duct Location

**Note: If using hood in recirculating mode skip these steps and turn to page 11.**

Vertical Ducting  
(7" Round)



1. Using a flat-head screwdriver, remove both the rectangular and round knock-out plates located on top of hood

2. Secure 7" round collar to top of hood using (6) M4 x 8 screws.

Vertical Ducting  
(3-1/4"x10" Rectangular)



1. Using a flat-head screwdriver, remove only the rectangular section of the knock-out plate located on top of hood.

2. Secure 3-1/4" x 10" rectangular collar to top of hood using (6) M4 x 8 screws.

Horizontal Ducting  
(3-1/4"x10" Rectangular)



1. Using a flat-head screwdriver, remove the rectangular knock-out plate located on back of hood.

2. Secure 3-1/4" x 10" rectangular collar to back of hood using (6) M4 x 8 screws.

**Note: To use hood in air recirculating mode please purchase recirculating kit ZRC-0200**

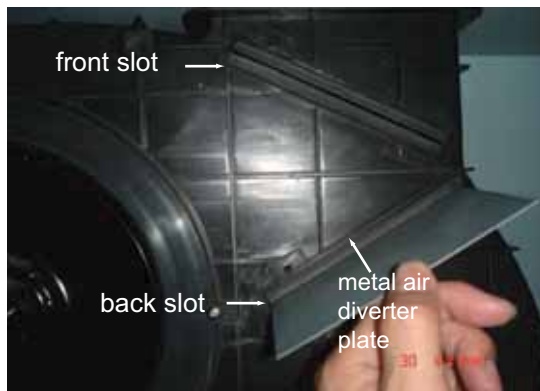

1. Remove air diverter plate slot covers. Remove metal air diverter plate from front slot and re-position to back slot. Re-install air diverter plate covers.

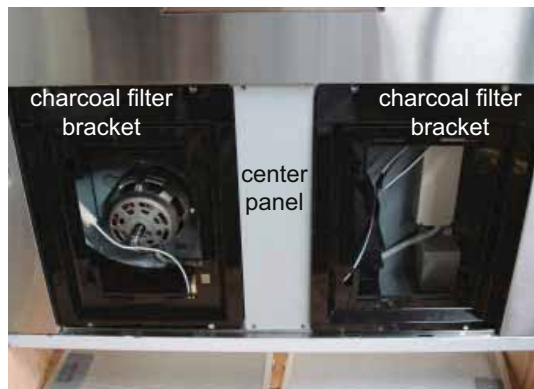

2. Using components from ZRC-0200, install (2) charcoal filter brackets and center panel to bottom of the hood with (4) screws for each component. Screws are pre-installed to the hood. Remove screws first to install brackets and center panel then re-install screws..



3. Install charcoal filters into charcoal filter brackets



4. Install the Aluminum mesh or Baffle filters

# Installation – Optional Utensil Bar

Note: Utensil bar is designed for use when hood is installed under a 12" deep cabinet. There are 3 height options for installing the utensil bar. Install utensil bar and adjust the height before mounting the hood. Utensil bar should press against the wall when hood is installed.

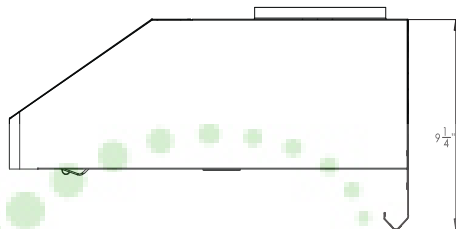
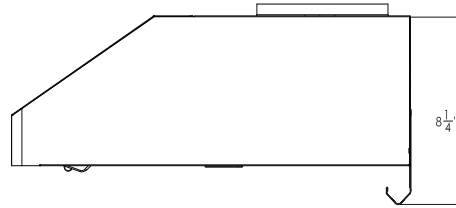

**AjMadison**  
Your Appliance Authority™  
800-570-3355

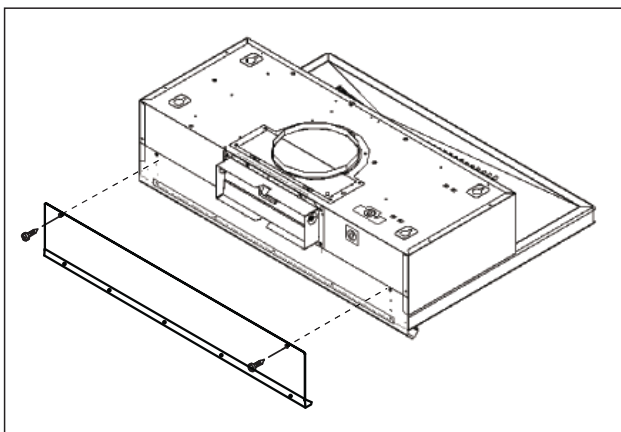

Fig 1

1. Secure utensil bar to back of hood using (2) M4x8 utensil bar screws.

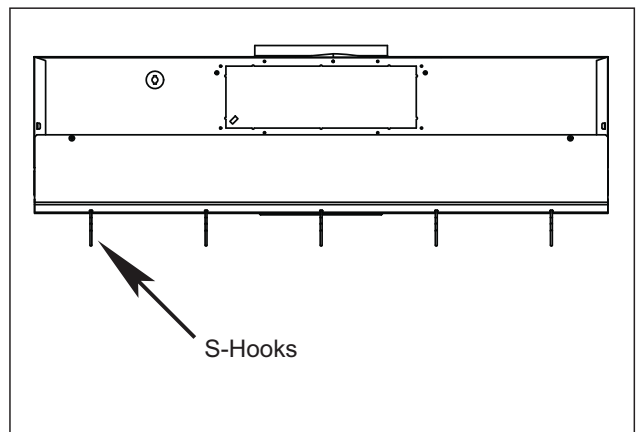

Fig 2

2. Install optional S hooks used to hang utensils.

**Hood is designed for installation under a kitchen cabinet**

1. Select preferred duct location (vertical or horizontal) if ducting out of kitchen. Refer to page 10 for details.
2. Begin installation by removing the filters.
3. Reinforce cabinet with 1"x2" wood strips if additional strengthening is required or if cabinets are framed.
4. Temporarily position the range hood in the desired mounting location. Measure and mark the mounting holes, duct and electrical locations with a pencil.
5. Drill/cut out the required openings for duct and electrical access; make sure the duct opening is large enough to apply duct tape.
6. Fasten hood onto cabinet with (4) M4 wood screws provided.
7. Install electrical.
8. Install duct work and seal with duct tape.
9. Reinstall the filters.
10. Power up hood and check for leaks around duct tape.
11. If recirculating the hood refer to page 11 for more details.

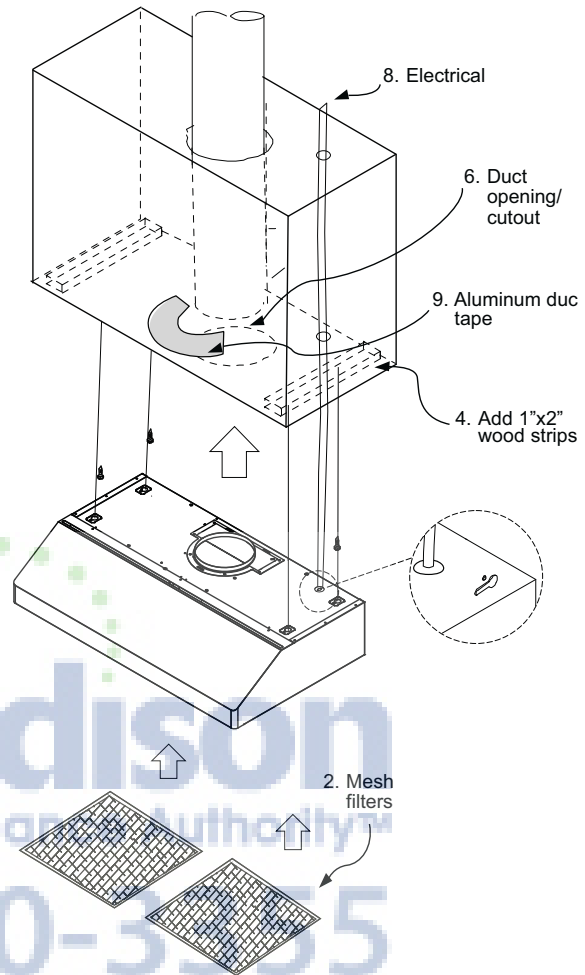
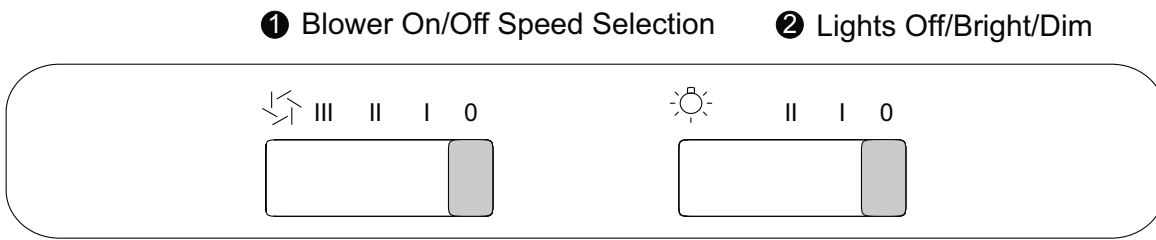

Fig 3

Controls – Slide Controls



**1 BLOWER ON/OFF/SPEED SELECTION**

0 is off, I is low speed, II is medium speed and III is high speed.

**2 LIGHTS OFF/BRIGHT/DIM**

0 is off, I is bright, and II is dim.





**SURFACE MAINTENANCE:**

Clean the hood surface periodically with hot soapy water and clean cotton cloth. Do not use corrosive or abrasive detergent, or steel wool/scouring pads which will scratch and damage surface. Do not use products containing chlorine bleach or orange cleaners.

For heavier soil use liquid degreaser.

After cleaning, you may use non-abrasive stainless steel polish/ cleaners, to polish and buff out the stainless luster and grain. Always scrub lightly using a micro fiber or clean cotton cloth and with grain.

**Aluminum Mesh or Baffle Filters**

The aluminum mesh or baffle filters are intended to trap residue and grease from cooking. Although the filters should never need replacing, they are required to be cleaned every 30 days or more often depending on cooking habits.

Filters may be placed in dishwasher at low heat or soaked in hot soapy water. Dry filters and re-install before using hood.

**Removing Mesh (Fig 4) & Baffle Filters (Fig 5)**

1. Push in on filter handles.
2. Pivot front of filter downward.
3. Remove filter by pulling away from hood.

**Replacment Aluminum Mesh Filters**

Hood Model:	Part No.	Qty. to Order.
AK7100AS & AK7136AS	50200030	2

**Replacment Baffle Filters**

Hood Model:	Part No.	Qty. to Order.
AK7100AS-BF & AK7136AS-BF	50210012	2

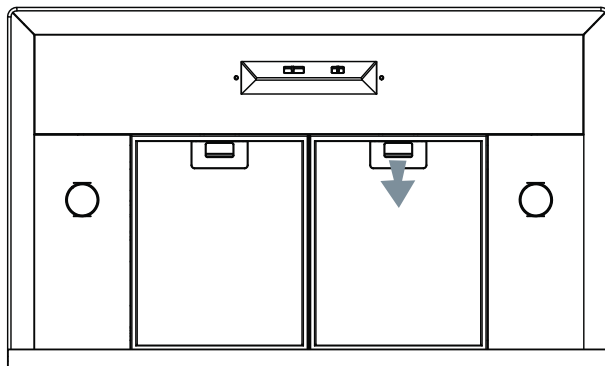

Fig 4

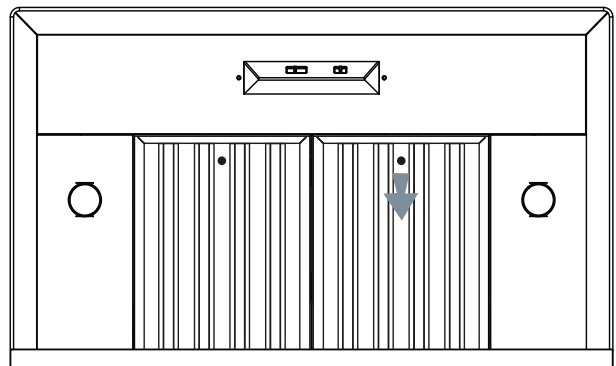

Fig 5

## REPLACING LIGHT BULBS

**CAUTION:** Light bulb becomes extremely hot when turned on.

**DO NOT touch bulb until switched off and cooled. Touching hot bulbs could cause serious burns.**

Make sure all power is turned off and bulbs are not hot.

Remove by turning bulb counter clockwise. **Note:** Bulb does not unscrew; it turns 60 degrees, stops and falls out.

If bulbs are difficult to turn due to prolonged use, firmly attach suction cup included in hardware package or use a rubber/latex glove and turn counter clockwise.

Replacement bulbs are available at specialty lighting stores. Purchase type MR16 (GU-10) 50W halogen.

For Zephyr part numbers please turn to page 19 of the manual.

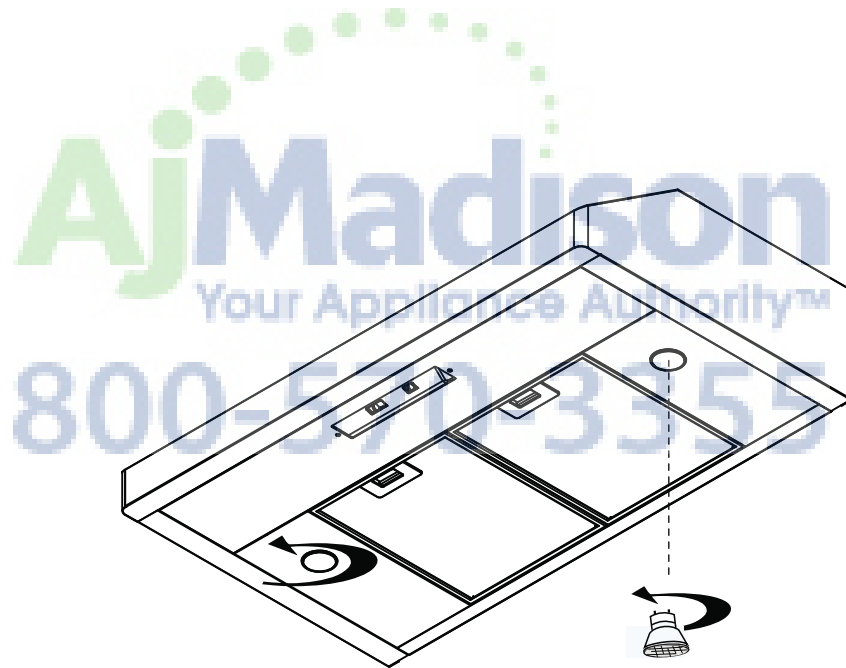

**TROUBLESHOOTING PROCEDURES FOR AK71**

<b>Issue</b>	<b>Cause</b>	<b>What to do</b>
After installation, the unit doesn't work.	1. The power source is not turned ON.	1. Make sure the circuit breaker and the unit's power is ON.
	2. The power line and the cable locking connector is not connecting properly.	2. Check the power connection with the unit is connected properly.
	3. The switch board and control board wirings are disconnected.	3. Make sure the wirings between the switch board and control board are connected properly.
	4. On the switch board, Black/White wire or White wire is disconnected.	4. Make sure the Black/White wire or White wire connects properly.
	5. The switch board or control board is defective.	5. Change the switch board or control board.
Light works, but motor is not turning.	1. The blower is defective, possible seized.	1. Change the blower.
	2. The thermally protected system detects if the motor is too hot to operate and shuts the motor down.	2. The motor will function properly after the thermally protected system cool down.
	3. Damaged capacitor.	3. Change the capacitor.
The unit is vibrating.	1. The blower is not secure in place.	1. Tighten the blower in place.
	2. Damaged blower wheel.	2. Change the blower.
	3. The hood is not secured in place.	3. Check the installation of the hood.
The motor is working, but the lights are not.	1. Defective halogen bulb.	1. Change the halogen bulb.
	2. The light bulb is loose.	2. Tighten the light bulb.
The hood is not venting out properly.	1. The hood might be hanging to high from the cook top.	1. Adjust the distance between the cook top and the bottom of the hood within 24" to 32" range.
	2. The wind from the opened windows or opened doors in the surrounding area are affecting the ventilation of the hood.	2. Close all the windows and doors to eliminate the outside wind flow.
	3. Blocking in the duct opening or duct work.	3. Remove all the blocking from the duct work or duct opening.
	4. The direction of duct opening is against the wind.	4. Adjust the duct opening direction.
	5. Using the wrong size of ducting.	5. Change the ducting to at least 7" or higher.
Metal filter is vibrating.	1. Metal filter is loose.	1. Verify spring clip is not broken.
	2. Spring clip is broken.	2. Replace the metal filter.

# Wiring Diagrams



182766

**Model: AK7100AS/AK7136AS**

**Voltage: 120V 60Hz**

**Power consumption**

**Total: Max. 207W @ 1.7A**

**Lamp: Max. 50Wx2**

**Fan: Max. 107W**

**THERMALLY PROTECTED**

**CIRCUIT DIAGRAM**

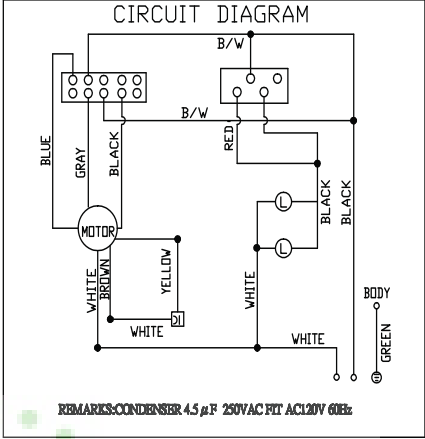

REMARKS: CONDENSER 4.5 μF 250VAC FIT AC120V 60Hz



182766

**Model: AK7100AS290**  
**AK7136AS290**

**Voltage: 120V 60Hz**

**Power consumption**

**Total: Max. 186W @ 1.55A**

**Lamp: Max. 50Wx2**

**Fan: Max. 86W**

**THERMALLY PROTECTED**

**CIRCUIT DIAGRAM**

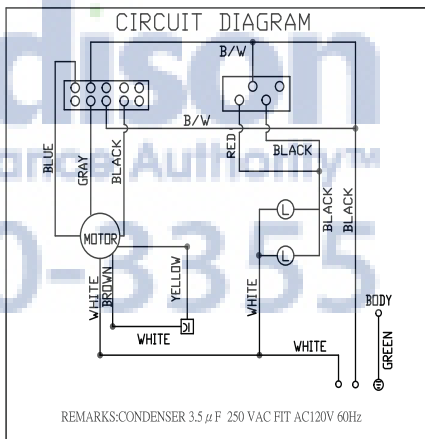

REMARKS: CONDENSER 3.5 μF 250 VAC FIT AC120V 60Hz

---

**DESCRIPTION****PART #****Replacement Parts**

Light Bulb MR16 (GU10) 50W (each)	Z0B-0020
Aluminum Mesh Filter	50200030
Baffle Filter	50210012

**Optional Accessories**

Recirculating Kit	ZRC-0200
Charcoal Filter Replacement (each)	Z0F-C002

To order parts, visit us online at <http://store.zephyronline.com> or call us at 1.888.880.8368



ESSENTIALS  
**ZEPHYR**  
Limited Warranty

**STAPLE YOUR RECEIPT HERE**  
**Proof of the original purchase**  
**date is needed to obtain**  
**service under warranty**

**TO OBTAIN SERVICE UNDER WARRANTY OR FOR ANY SERVICE RELATED QUESTIONS, please call:**  
**1-888-880-8368**

Zephyr Corporation (referred to herein as “we” or “us”) warrants to the original consumer purchaser (referred to herein as “you” or “your”) of Zephyr products (the “Products”) that such Products will be free from defects in materials or workmanship as follows:

**Three Year Limited Warranty for Parts:** For three years from the date of your original purchase of the Products, we will provide, free of charge, Products or parts to replace those that failed due to manufacturing defects. We may choose, in our sole discretion, to repair or replace parts before we elect to replace the Products.

**One Year Limited Warranty for Labor:** For one year from the date of your original purchase of the Products, we will provide, free of charge, the labor cost associated with repairing the Products or parts to replace those that failed due to manufacturing defects. After the first year from the date of your original purchase, you are responsible for all labor costs associated with this warranty.

**Warranty Exclusions:** This warranty covers only repair or replacement, at our option, of defective Products or parts and does not cover any other costs related to the Products including but not limited to: (a) normal maintenance and service required for the Products and consumable parts such as light bulbs, metal and carbon filters and fuses; (b) any Products or parts which have been subject to freight damage, misuse, negligence, accident, faulty installation or installation contrary to recommended installation instructions, improper maintenance or repair (other than by us); (c) commercial use of the Products or use otherwise inconsistent with its intended purpose; (d) natural wear of the finish of the Products or wear caused by improper maintenance, use of corrosive and abrasive cleaning products, pads, and oven cleaner products; (e) chips, dents or cracks caused by abuse or misuse of the Products; (f) service trips to your home to teach you how to use the Products; or (g) damage to the Products caused by accident, fire, floods or act of God. If you are outside our service area, additional charges may apply for shipping costs for warranty repair at our designated service locations and for the travel cost to have a service technician come to your home to repair, remove or reinstall the Products. After the first year from the date of your original purchase, you are also responsible for all labor costs associated with this warranty.

**Limitations of Warranty. OUR OBLIGATION TO REPAIR OR REPLACE, AT OUR OPTION, SHALL BE YOUR SOLE AND EXCLUSIVE REMEDY UNDER THIS WARRANTY. WE SHALL NOT BE LIABLE FOR INCIDENTAL, CONSEQUENTIAL OR SPECIAL DAMAGES ARISING OUT OF OR IN CONNECTION WITH THE USE OR PERFORMANCE OF THE PRODUCTS. THE EXPRESS WARRANTIES IN THE PRECEDING SECTION ARE EXCLUSIVE AND IN LIEU OF ALL OTHER EXPRESS WARRANTIES. WE HEREBY DISCLAIM AND EXCLUDE ALL OTHER EXPRESS WARRANTIES FOR THE PRODUCTS, AND DISCLAIM AND EXCLUDE ALL WARRANTIES IMPLIED BY LAW, INCLUDING THOSE OF MERCHANTABILITY AND FITNESS FOR A PARTICULAR PURPOSE.** Some states or provinces do not allow limitations on the duration of an implied warranty or the exclusion or limitation of incidental or consequential damages, so the above limitations or exclusions may not apply to you. To the extent that applicable law prohibits the exclusion of implied warranties, the duration of any applicable implied warranty is limited to the same two-year period described above. Any oral or written description of the Products is for the sole purpose of identifying the Products and shall not be construed as an express warranty. Prior to using, implementing or permitting use of the Products, you shall determine the suitability of the Products for the intended use, and you shall assume all risk and liability whatsoever in connection with such determination. We reserve the right to use functionally equivalent refurbished or reconditioned parts or Products as warranty replacements or as part of warranty service. This warranty is not transferable from the original purchaser and applies in the United States and Canada.

**To Obtain Service Under Limited Warranty:** To qualify for warranty service, you must: (a) notify us at the address or telephone number stated below within 60 days of the discovery of the defect; (b) give the model number and part identification number and serial number; and (c) describe the nature of any defect in the Product or part. At the time of the request for warranty service, you must present evidence of your proof of purchase and proof of the original purchase date. If we determine that the warranty exclusions listed above apply or if you fail to provide the necessary documentation to obtain service, you will be responsible for all shipping, travel, labor and other costs related to the services.

Please check our website for any revisions, [www.zephyronline.com](http://www.zephyronline.com).

**Zephyr Corporation Service Department, 2277 Harbor Bay Parkway, Alameda, CA 94502 1-888-880-8368**