

# INSTALLATION

Your refrigerator was packed carefully for shipment. Remove and discard shelf packaging and tape. Do not remove the serial plate.

## Location

- Do not install refrigerator near oven, radiator or other heat source. If not possible, shield refrigerator with cabinet material.
- Do not install where temperature falls below 55° F (13° C) or rises above 110° F (43° C). Malfunction may occur at this temperature.
- **Refrigerator is designed for indoor household application only.**

## Measuring the Opening

When installing your refrigerator, measure carefully. Allow ½" space at top and ½" space behind the machine compartment cover (located in the rear) for proper air circulation.

Subflooring or floor coverings (i.e. carpet, tile, wood floors, rugs) may make your opening smaller than anticipated.

Some clearance may be gained by using the leveling procedure under *Leveling*.

**IMPORTANT:** If refrigerator is to be installed into a recess where the top of the refrigerator is completely covered, use distance from floor to top of hinge cap to verify proper clearance.

## Transporting Your Refrigerator

- **NEVER** transport refrigerator on its side. If an upright position is not possible, lay refrigerator on its back. Allow refrigerator to sit upright for approximately 30 minutes before plugging it in to assure oil returns to the compressor. Plugging the refrigerator in immediately may cause damage to internal parts.
- Use an appliance dolly when moving refrigerator. **ALWAYS** truck refrigerator from its side or back—**NEVER** from its front.
- Protect outside finish of refrigerator during transport by wrapping cabinet in blankets or inserting padding between the refrigerator and dolly.
- Secure refrigerator to dolly firmly with straps or bungee cords. Thread straps through handles when possible. Do not overtighten. Overtightening restraints may dent or damage outside finish.

## Glass Panel Doors (select models)

### CAUTION

To avoid possible injury, product or property damage, observe the following:

- When working directly on the doors, protect the door corners and sides by placing doors on a nonabrasive surface protected by towels or rugs.
- Protect the glass panel sides when securing the unit to a dolly. **DO NOT OVERTIGHTEN!** Overtightening the restraints may shatter the glass which could cause personal injury.
- **DO NOT** carry or transport removed doors by the handles.
- Fully tighten handle set screws when installing the door handles.

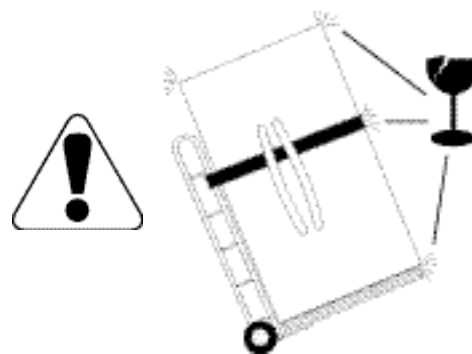

# INSTALLATION

## Leveling

### CAUTION

To protect property and refrigerator from damage, observe the following:

- Protect vinyl or other flooring with cardboard, rugs, or other protective material.
- Do not use power tools when performing leveling procedure.

To enhance the appearance and maintain performance, the refrigerator should be level.

### Note

- Complete any required door reversal, panel installation and/or a water supply connection, before leveling.

### Materials Needed:

- $\frac{3}{8}$ " hex head driver
- Carpenter's level

#### 1. Remove toe grille.

- Grasp firmly and pull outward to unclip.

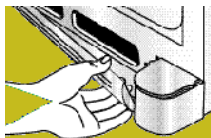

#### 2. Remove bottom hinge cover(s).

- Place the eraser end of a pencil or similar blunt tool in the cover notch.

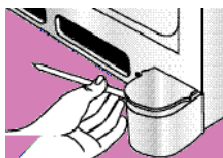

Notch Location

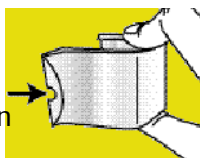

- Use slight pressure to pry the cover loose.
- Continue to maintain downward pressure to the notched side of the cover while swinging it off.

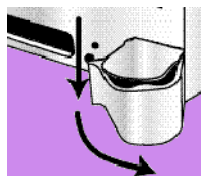

3. Using hex head driver, turn the front adjustment screws (A) on each side to raise or lower the front of the refrigerator.

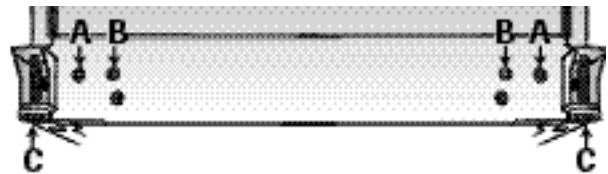

### Note

- Some models only have adjustment screws "A."

4. Using the hex head driver, turn each of these adjustment screws (B) to raise or lower the rear of the refrigerator.
5. Using the carpenter's level, make sure front of refrigerator is  $\frac{1}{4}$ " (6 mm) or  $\frac{1}{2}$  bubble higher than back of refrigerator and that the refrigerator is level from side to side.
6. Turn stabilizing legs (C) clockwise until firmly against floor.
7. Turn adjustment screws (A) counterclockwise to allow the full weight of the refrigerator to rest on the stabilizing legs.
8. Replace bracket cover(s).
  - Position cover into the outer edge of the hinge.
  - Swing the cover toward the cabinet and snap it into place.
9. Replace the toe grille.

### Note

- For proper reinstallation, ensure the "top" marking on the interior of the toe grille is oriented correctly.
- Align the toe grille mounting clips with the lower cabinet slots.
- Push the toe grille firmly until it snaps into place.

# INSTALLATION

## Door and Drawer Removal

Some installations require door/drawer removal to transport the refrigerator to its final location.

### WARNING

To avoid electrical shock which can cause severe personal injury or death, observe the following:

- Disconnect power to refrigerator before removing doors or drawer. Connect power only after replacing doors or drawer.

### CAUTION

To avoid damage to walls and flooring, protect vinyl or other flooring with cardboard, rugs or other protective material.

1. Unplug power cord from power source.
2. Remove toe grille and bottom hinge cover(s) (see page 4).
3. Remove top hinge cover from refrigerator door by removing Phillips screw and retain screw and cover for later use.

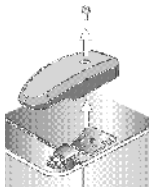

4. Unscrew  $\frac{5}{16}$ " hex head screws from top hinge to remove hinge and retain all screws for later use.

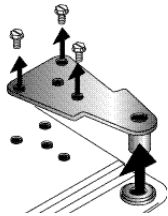

5. Lift right side refrigerator door from center hinge pin. Remove door closure from center hinge pin on the right side and retain for later use.

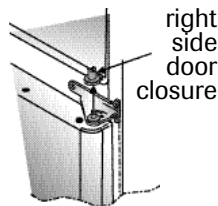

6. Disconnect wire harness on top of left side refrigerator door top hinge.

Release two-pin connector by pressing junction point with a flat blade screwdriver or fingernail.



Green ground wire remains attached to the hinge.

7. Unscrew  $\frac{5}{16}$ " hex head screws from top hinge to remove hinge and retain for later use.

Lift left side refrigerator door, along with top hinge, from center hinge pin.

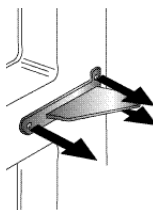

Remove center hinge pin with a  $\frac{5}{16}$ " hex head driver and retain hinge pin for later use.

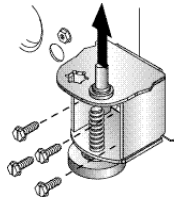

8. Remove Phillips screws to remove right and left hinges and retain all screws for later use.

9. Remove both stabilizing brackets with  $\frac{3}{8}$ " hex head driver and retain screws for later use.

## Pullout Freezer Drawer (select models)

### DANGER

To prevent accidental child entrapment or suffocation risk, do not remove the divider in the top freezer basket.

### WARNING

To avoid electrical shock which can cause severe personal injury or death, disconnect power to refrigerator before removing doors. After replacing doors, connect power.

### CAUTION

To avoid possible injury, product, or property damage, you will need two people to perform the following instructions.

#### To Remove:

1. Pull drawer open to full extension.
2. Tilt the lower basket forward and lift to remove.

3. On each white drawer bracket is a basket cradle with two snap attachments. To release each cradle, unlatch the snaps by pushing them inward, away from the side bracket. Lift the cradles off of the rails.

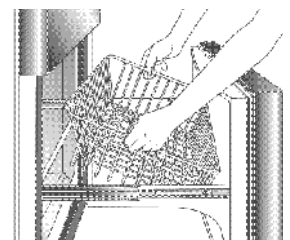

4. Remove Phillips screw from each of the drawer slides (select models).

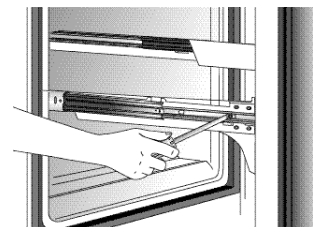

# INSTALLATION

5. Lift top of drawer front to unhook the drawer from the slides. Lift door front out to remove.

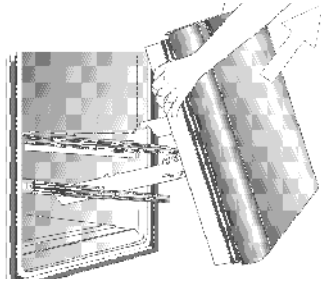

## To Install:

1. Pull both rails out to full extension.

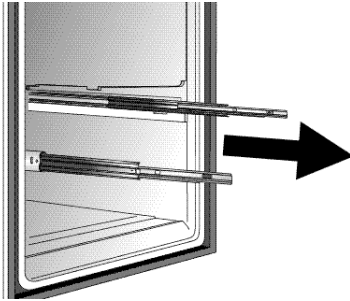

2. While supporting door front, hook supports into slots located on inside of each slide.

## Note

- All four drawer bracket supports must be in the proper slots for the drawer to function properly.

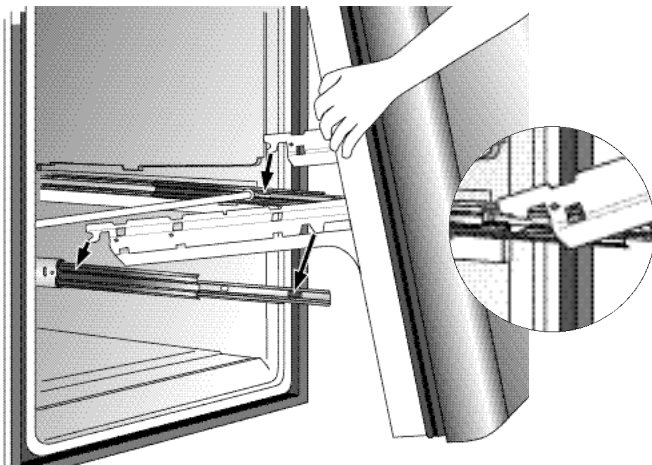

3. Lower door front into final position.
4. Replace and tighten Phillips screws that were removed from the drawer slides (select models).
5. Place the basket cradles back onto the drawer slides. Align basket cradle snaps with the slots on the drawer brackets and press each cradle towards the bracket until it clicks.

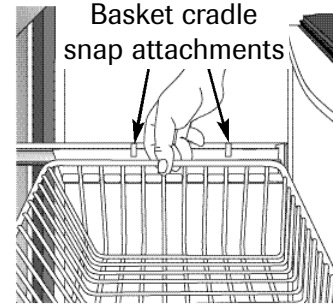

6. Tilt the lower basket front down and set it down into the basket cradles.

## Door Reinstallation

1. Install hinge assemblies:
  - Install center hinge with Phillips screws.
2. Place hinge side of refrigerator door on center hinge pin.
  - Install top hinge with  $\frac{5}{16}$ " hex head screws.
3. While holding refrigerator door upright, tighten down top hinge with  $\frac{5}{16}$ " hex head driver.
4. Reconnect two-pin connector.
5. Replace top hinge covers.

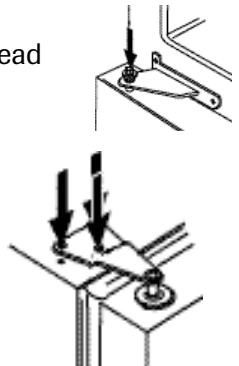

## Handles (style varies by model)

This handle style is installed at the factory. Style may vary by model.

### Materials Needed:

- $\frac{3}{32}$ " allen wrench

### To Remove:

- Remove set screw from handle mounting post using the  $\frac{3}{32}$ " allen wrench.
- Repeat the procedure on all posts to remove the handle.

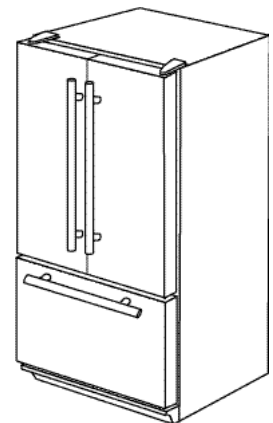

### To replace:

- Align handle with the mounting posts.
- Fully tighten all set screws to secure handle in place.

# INSTALLATION

## Installing Front-Mounted Handles for Stainless Steel Door

1. Loosen lower door clip on door with a phillips screwdriver.

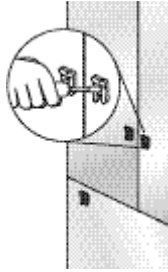

2. Locate predrilled hole at base of handle, and fit hollow end of handle over lower door clip.



3. Fit other end of handle over upper door clip and slide up as far as possible.

**NOTE:** If top of handle does not fit over top clip, loosen lower clip further until fit can be accomplished.

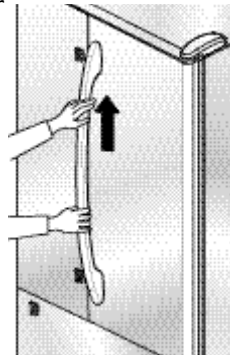

4. Insert phillips screwdriver into predrilled hole at base of handle to tighten screw. Insert plastic button plug into hole.

5. Repeat above steps to install other handle.

## Removing Front-Mounted Handles for Stainless Steel Door

1. Remove plastic button plug at base of handle with a very small flat-blade screwdriver.

- Insert phillips screwdriver into predrilled hole to remove screw.



2. Slide handle down and remove from door clip.

3. Repeat above steps to remove other handle.

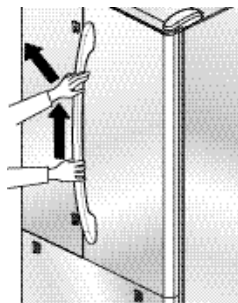

## Installing Front-Mounted Handles for Stainless Steel Freezer Door

1. Loosen lower door clip on door with a phillips screwdriver.

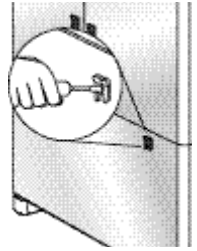

2. Locate predrilled hole at base of handle, and fit hollow end of handle over left door clip.

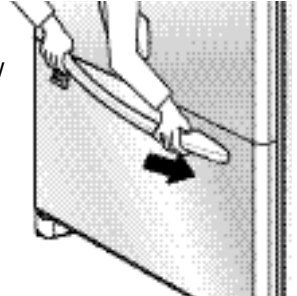

3. Fit other end of handle over left door clip and slide left as far as possible.

**NOTE:** If end of handle does not fit over left clip, loosen right clip further until fit can be accomplished.

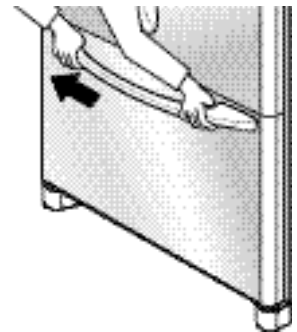

4. Insert phillips screwdriver into predrilled hole at end of handle to tighten screw. Insert plastic button plug into hole.

## Removing Front-Mounted Handles for Stainless Steel Freezer Door

1. Remove right side plastic button plug at end of handle with a very small flat-blade screwdriver.

- Insert phillips screwdriver into predrilled hole to remove screw.



2. Slide handle right and remove from door clip.

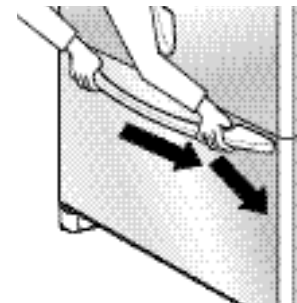

# INSTALLATION

## Opening and Closing Your Fresh Food Doors

Your new refrigerator is uniquely designed with two fresh food doors. Either door can be opened or closed independently of one another.

There is a vertically-hinged section on the left fresh food door. When the left door is closed, the hinged section automatically forms a seal between the two doors when both doors are closed.

When the left door is opened, the hinged seal automatically folds inward so that it is out of the way.

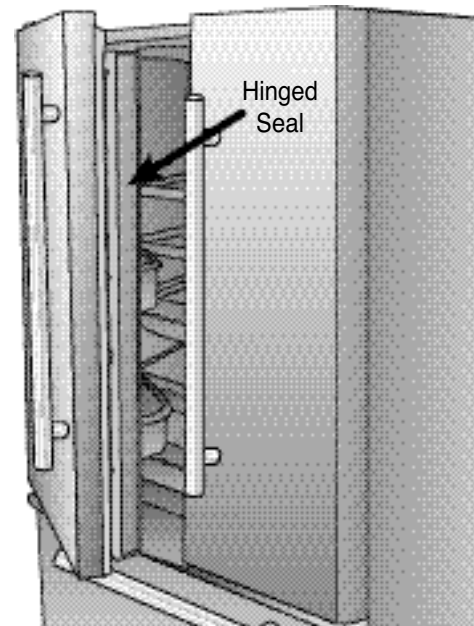

### **WARNING**

To avoid electrical shock which can cause severe personal injury or death, **DO NOT** attempt to remove the hinged seal from the fresh food section.

### **CAUTION**

To avoid possible product damage, **ALWAYS** verify that the hinged seal is folded against the edge of the door prior to closing.

# INSTALLATION

## Connecting the Water Supply

### WARNING

To reduce the risk of injury or death, follow basic precautions, including the following:

- Read all instructions before installing ice maker.
- Do not attempt installation if instructions are not understood or if they are beyond personal skill level.
- Observe all local codes and ordinances.
- Do not service ice maker unless specifically recommended in Use & Care Guide or published user-repair instructions.
- Disconnect power to refrigerator before installing ice maker.
- Water damage due to an improper water connection may cause mold/mildew growth. Clean up spills or leakage immediately!

### CAUTION

To avoid property damage or possible injury, follow basic precautions, including the following:

- Consult a plumber to connect  $\frac{1}{4}$ " O.D. copper tubing to household plumbing to assure compliance with local codes and ordinances.
- Confirm water pressure to water valve is between 35 and 100 pounds per square inch, 20 pounds per square inch without filter.
- Do not use a self-piercing, or  $\frac{3}{16}$ " saddle valve. Both reduce water flow and can become clogged over time, and may cause leaks if repair is attempted.
- Tighten nuts by hand to prevent cross threading. Finish tightening nuts with pliers and wrenches. Do not overtighten.
- Wait two to three hours before placing refrigerator into final position to check and correct any water leaks. Recheck for leaks after 24 hours.
- Verify the copper tubing under the sleeve is smooth and free from defects. Do not reuse an old sleeve.

### Materials Needed:

- $\frac{1}{4}$ " outer diameter flexible copper tubing
- Shut-off valve (requires a  $\frac{1}{4}$ " hole to be drilled into water supply line before valve attachment)
- Adjustable wrench
- $\frac{1}{4}$ " hex nut driver

### Notes

- Use copper tubing only for installation. Plastic is less durable and can cause damage.
- Add 8' to tubing length needed to reach water supply for creation of service loop.

1. Create service loop with copper tubing (minimum 2' diameter). Avoid kinks in the copper tubing when bending it into a service loop. Do not use plastic tubing.

2' diameter minimum

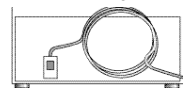

2. Remove plastic cap from water valve inlet port.



3. Place brass nut (A) and sleeve (B) on copper tube end as illustrated.

**Reminder:** Do not use an old sleeve. The nut and sleeve are provided in the use and care packet.

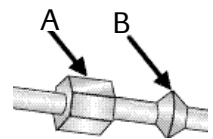

4. Place end of copper tubing into water valve inlet port. Shape tubing slightly. Do not kink – so that tubing feeds straight into inlet port.

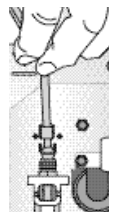

5. Slide brass nut over sleeve and screw nut into inlet port. Tighten nut with wrench.

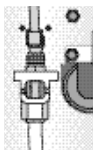

**IMPORTANT:** Do not overtighten. Cross threading may occur.

6. Pull on tubing to confirm connection is secure. Connect tubing to frame with water tubing clamp (C) and turn on water supply. Check for leaks and correct if necessary. Continue to observe the water supply connection for two to three hours prior to moving the refrigerator to its permanent location.

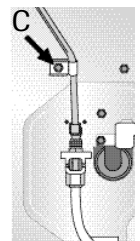

7. Monitor water connection for 24 hours. Correct leaks, if necessary.