

USER GUIDE

ActiveSmart™ Integrated Refrigerator

RS36A72, RS36A80 and RS36W80 models

US CA

Fisher & Paykel



CONTENTS

Introduction	3
Safety and warnings	4
Moving and storing your appliance	7
Storage features list	8
Operating instructions	10
Special functions	13
External display (Ice & Water models only)	15
Using your water dispenser (Ice & Water models only)	16
Water filter	17
Using your Ice maker	19
ActiveSmart™ refrigerator special features	21
Cleaning care - Exterior	23
Cleaning care - Interior	26
Storing food in your refrigerator	28
Storing food in your freezer	30
Defrosting food in your refrigerator	32
User warnings and sounds	33
Troubleshooting	34
Service and Warranty	38

IMPORTANT!

SAVE THESE INSTRUCTIONS

The models shown in this user guide may not be available in all markets and are subject to change at any time. For current details about model and specification availability in your country, please go to our websites; www.fisherpaykel.com or www.dcsappliances.com, or contact your local Fisher & Paykel or DCS dealer.

Note that the word 'refrigerator', throughout this user guide, refers to the combination of refrigerator/freezer products.

Registration

Register your product with us so we can provide you with the best service possible.

To register your product visit our website: www.fisherpaykel.com or www.dcsappliances.com

INTRODUCTION

Thank you for buying this Fisher & Paykel integrated refrigerator.

Introducing the next generation in Fisher & Paykel refrigeration. With new flush-fit design and the ability to easily slide into existing kitchen spaces or be integrated behind kitchen cabinetry, these family-sized fridges offer a seamless look to the kitchen while providing excellent food care.

As your life changes, so can your refrigerator. This book explains the features and functions, and will help you get the most out of your refrigerator.

We hope you enjoy your new integrated refrigerator.

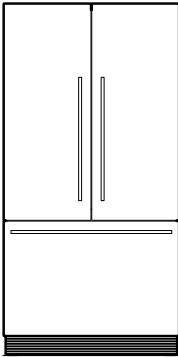

RS36A72J
(models with internal ice maker)*

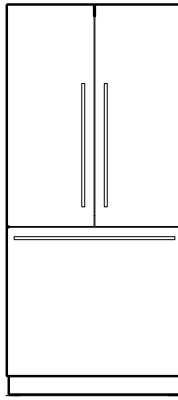

RS36A80J
(models with internal ice maker)*

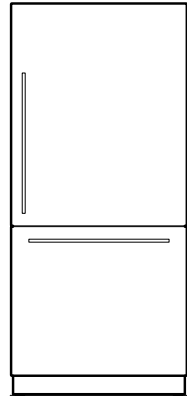

RS36W80J
(models with internal ice maker)*

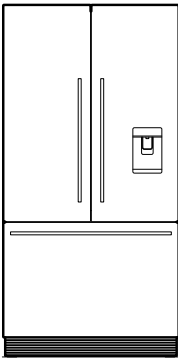

RS36A72U
(Ice & Water models)*

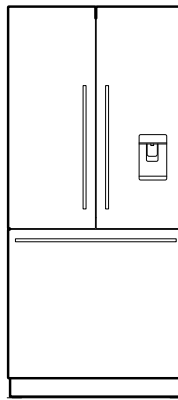

RS36A80U
(Ice & Water models)*

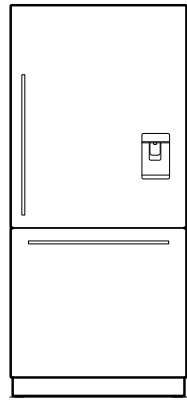

RS36W80U
(Ice & Water models)*

* All models are shown with Fisher & Paykel EZKleen stainless steel door panel sets.

SAFETY AND WARNINGS



WARNING!



Electric Shock Hazard

Read and follow the safety and warnings outlined in this user guide before operating this appliance.

Failure to do so can result in death, electric shock, fire or injury to persons.

Use this appliance only for the intended purpose as described in the user guide.

IMPORTANT SAFETY INSTRUCTIONS

WARNING!

When using this appliance always exercise basic safety precautions including the following:

- This appliance is not intended for use by persons (including children) with reduced physical, sensory or mental capabilities, or lack of experience and knowledge, unless they have been given supervision or instruction concerning use of the appliance by a person responsible for their safety.
- Children should be supervised to ensure they do not play with the appliance.
- The manufacturer's installation instructions for product and cabinetry ventilation must be followed when installing the appliance.
- To avoid hazard due to instability of the appliance, it must be fixed in accordance with installation instructions.
- Keep ventilation openings, in the appliance enclosure or in the built-in structure, clear of obstruction.
- Do not use mechanical devices or other means to accelerate the defrosting process, other than those recommended by the manufacturer.
- Do not damage the refrigerant circuit.
- In case of damage to the refrigerant circuit, ventilate the area by opening all windows. Do not operate electrical equipment or any other equipment that may produce arcs, sparks or flames in the area. Contact your Fisher & Paykel trained and supported service technician immediately to arrange for the appliance to be repaired.
- Do not use electrical appliances inside the food storage compartments of the appliance, unless they are of the type recommended by the manufacturer.

Electrical

- This appliance must be installed in accordance with the installation instructions before use.
- To allow disconnection of the appliance from the supply after installation, incorporate a switch in the fixed wiring in accordance with the wiring rules.
- Never unplug your refrigerator by pulling on the power cord. Always grip the plug firmly and pull straight out from the outlet.
- Do not plug in any other appliance at the same power point as your refrigerator or use extension cords or double adapters or ungrounded (two prong) adapters.
- Repair or replace immediately all electric service cords that have become frayed or otherwise damaged. Do not use a cord that shows cracks or abrasion along its length or at either the plug or appliance end.

SAFETY AND WARNINGS

- If the power supply cord is damaged, it must only be replaced by your Fisher & Paykel trained and supported service technician because special purpose tools are required.
- When moving your appliance away from the wall, be careful not to roll over or damage the power cord.
- Follow the National Electrical Code and all local codes and ordinances when installing this product.
- **Warning:** Ground Fault Circuit Interrupters (GFCI) may trip during normal operation of your refrigerator and interrupt the power supply. The use of a GFCI is not recommended with this product.

IMPORTANT!

Your refrigerator is designed to operate for many years without the need for service checks. However, if your refrigerator is malfunctioning, have it attended to by your Fisher & Paykel trained and supported service technician as soon as possible. All electrical repairs must be carried out by an adequately trained service technician or qualified electrician.

Cleaning

- Many commercially available cleaning products contain solvents that may attack the plastic components of your refrigerator and cause them to crack.
- Avoid using anti-bacterial cleaning products on either the interior or exterior of the cabinet as they may cause rusting of metal components and cracking of plastic components.
- Please refer to the 'Cleaning care' section of this user guide for further information.

Disposal

Extreme care must be taken when disposing of your old appliance to avoid hazards:

- The flammable refrigerant gas must be safely removed.
- The thermal insulation foam in this appliance contains flammable insulation blowing gases, any exposed foam may be highly flammable and must be carefully treated during disposal.
- The refrigerator doors and/or door panel set(s) should be removed and the shelves left in place so that children may not easily climb inside.
- Your Fisher & Paykel trained and supported service technician will be able to give advice on environmentally friendly methods of disposing of your old refrigerator or freezer.

Storing food and drinks

- Do not store explosive substances such as aerosol cans with a flammable propellant in this appliance.
- Never store volatile or flammable materials in your refrigerator as they may explode.
- Never freeze liquids in glass containers. Liquid expands during freezing, which may cause the container to explode.
- Never freeze carbonated drinks. They may explode.
- Do not consume food if it is too cold. Food removed from the freezer compartment may be cold enough to cause damage when brought into contact with bare skin, eg frozen ice cubes.

SAFETY AND WARNINGS

Power failure - food safety

- **Do not refreeze frozen foods that have thawed completely. The food may be dangerous to eat. Follow the recommendations below if you discover food in your freezer has thawed:**
 - **Ice crystals still visible - food may be refrozen but should be stored for a shorter period than recommended.**
 - **Thawed but refrigerator cold - refreezing generally not recommended. Fruits and some cooked food can be refrozen but use as soon as possible. Meat, fish, poultry - use immediately or cook then refreeze. Vegetables - discard as they usually go limp and soggy.**
 - **Thawed and warmer than 41°F (5°C) - discard all food.**

MOVING AND STORING YOUR APPLIANCE

TO ENSURE YOUR APPLIANCE OPERATES CORRECTLY PLEASE REFER TO THE INSTALLATION INSTRUCTIONS BOOKLET SUPPLIED WITH THIS PRODUCT.

If your refrigerator is turned off for any reason, wait 10 minutes before turning it back on. This will allow the refrigeration system pressures to equalize before restarting.

Moving your appliance

- Turn off the appliance at the isolating switch and unplug from the power point. Remove all food.
- Refer to the installation instructions to free the refrigerator from its surrounds. Gently ease the appliance out of its position, switch isolating faucet off and disconnect water fittings; and tuck the power cord away.
- If applicable, tape the shelves in place and tape the doors closed. If the cabinet needs to be placed on an angle or laid down, carefully lay it on its side (the right-hand side when viewed from the front).
- Relocate and install. If the appliance has been left on its side for any length of time, leave it standing upright as long as possible (at least a few hours) before turning it on.
- If the product has been transported upright then it can be switched on after 10 minutes.

Storing your appliance

- When storing your cleaned appliance, leave the door(s) open. This allows air to circulate and prevents the build up of bacteria and molds.
- Before using again, clean well using a mixture of warm water and baking soda (add 1tsp of baking soda to each 16.9oz (500ml) of water). Rinse with clean water.

Holiday time

We recommend you leave your refrigerator operating while you are on vacation or away from home for extended periods. Remove all perishable food.

- Turn the ice maker off on the **internal** control panel.
- Shut off the water supply to the refrigerator.
- On your return, turn on the water supply to the refrigerator.
- Turn on the ice maker.
- Discard the first 24 hours of ice harvest.

For Ice & Water models

Dispense 4qt (4L) of water and discard to ensure the water tank is refilled with fresh water.

STORAGE FEATURES LIST

RS36A72 and RS36A80 models

Refrigerator compartment*

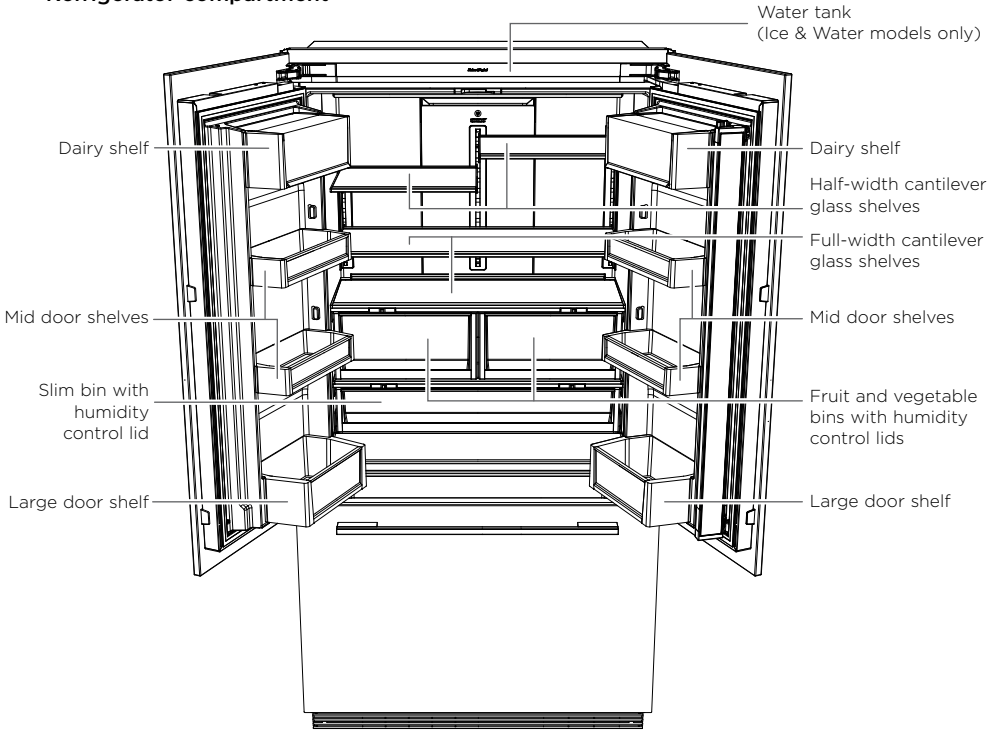

Freezer compartment*

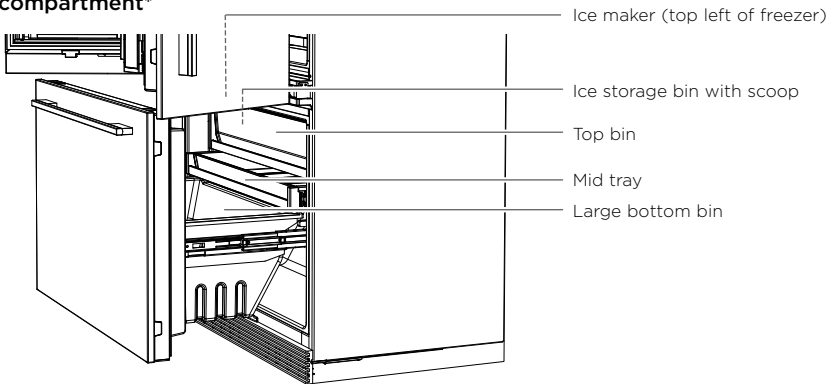

Accessories (not shown)

- Single bottle holders

* All storage features are the same for RS36A72 and RS36A80 models.

STORAGE FEATURES LIST

RS36W80 models

Refrigerator compartment*

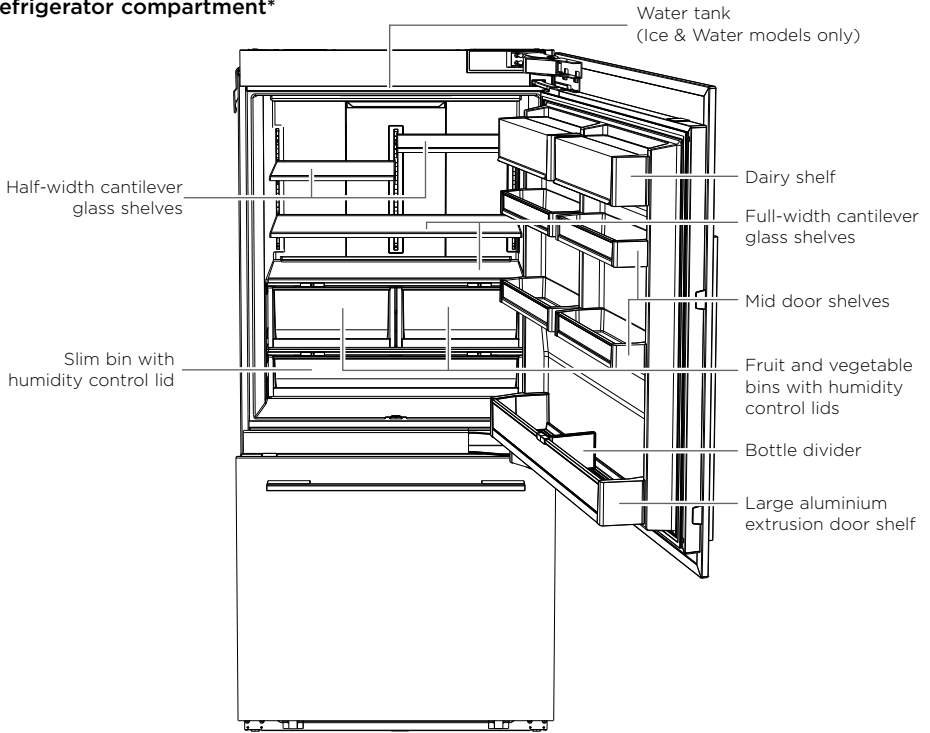

Freezer compartment*

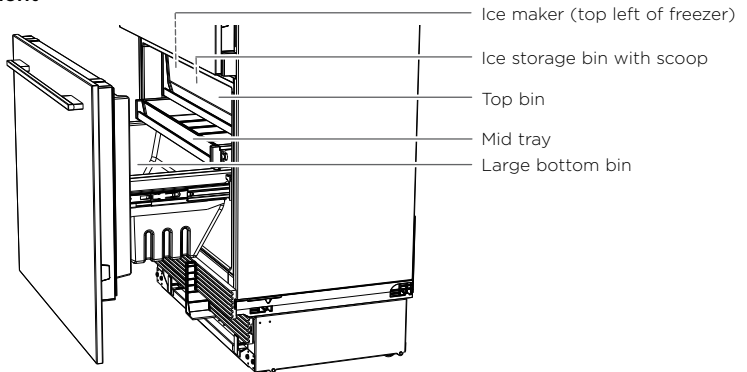

Accessories (not shown)

- Single bottle holders

* All storage features are the same for RS36W80 models.

OPERATING INSTRUCTIONS

Internal control panel

The **internal** control panel enables you to view and modify all the features and options of your refrigerator.

Temperature control

- When the refrigerator is first turned on, the cooling system will automatically cool both refrigerator and freezer compartments to their set temperatures. This will take between 2 - 3 hours.
- It is recommended to check the operation of the refrigerator periodically once every 4 hours up to a period of 24 hours.
- The two compartment temperatures are accurately and independently controlled and do not change with the temperature or humidity of the surroundings, whether summer or winter.
- If you wish to alter the temperature of either the fresh food compartment or freezer compartment, this can be easily done by using the **internal** control panel located on the right hand side of the refrigerator compartment.
- Once food is added to the product, allow at least 12 hours for the product to reach the selected cooling temperatures.
- If at any time you notice that the refrigerator is not cooling properly, call your installer/Fisher & Paykel trained and supported service technician to verify the unit is operating properly. Take immediate steps to prevent food from spoiling by storing in another refrigerator or freezer.

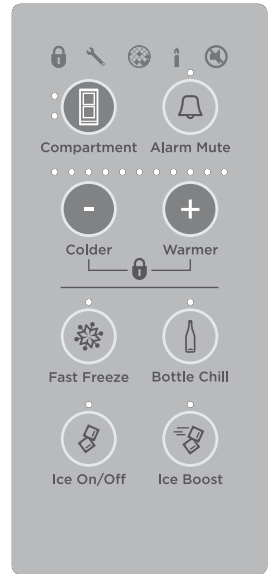



Internal control panel
for all models

Adjusting the fresh food compartment temperature

When the fresh food compartment door(s) are opened the interior light automatically illuminates. The temperature for this compartment will show as a series of lights.

- To increase the temperature press the **+** button, this will increase the number of lights.
- To decrease the temperature press the **-** button, this will decrease the number of lights.
- Fewer lights illuminated indicates a colder temperature for the compartment selected.



Adjusting the freezer compartment temperature

- Press the  button once, the freezer compartment light will be illuminated.
- To increase the temperature press the **+** button, this will increase the number of lights.
- To decrease the temperature press the **-** button, this will decrease the number of lights.
- Fewer lights illuminated indicates a colder temperature for the compartment selected.
- Note: successively pressing the  button will scroll between compartments.
- When the door is re-opened the control panel will return automatically to the fresh food compartment setting.

OPERATING INSTRUCTIONS

Alarm Mute





For times when you require the door to be opened longer than normal eg when cleaning the interior of your refrigerator the 'Alarm Mute' can be activated to silence the door alarm for 20 minutes.

- To activate, press the  button once. The 'Alarm Mute' light will be illuminated when the function is activated.
- 'Alarm Mute' will deactivate after 20 minutes and the door alarms will return to normal.
- To deactivate 'Alarm Mute' manually, press the  button again. When 'Alarm Mute' is deactivated the light is off.

Note: when the fresh food or freezer compartment door is left open for longer periods of time food quality and/or safety may be compromised.



Key mute

Key mute allows you to silence all button presses.

- To activate key mute, press and hold the  button for 4 seconds.
- The  icon on the **internal** control panel will be illuminated.
- The keys will be silenced when key mute is activated.
- Door alarms and 'Bottle Chill' alarm will still operate.
- Key mute will not automatically deactivate. To manually deactivate, press and hold the  button for 4 seconds.
- The  icon will no longer be illuminated.

Key lock





Key lock allows you to disable the buttons on the **internal** control panel. This is useful when cleaning your refrigerator.

- To activate key lock press and hold the **-** and **+** buttons for 4 seconds.
- The  icon on the **internal** control panel will be illuminated.
- Pressing any of the buttons will cause several beeps to tell you that they are disabled.
- Key lock will not automatically deactivate. To manually deactivate, press and hold the **-** and **+** buttons for 4 seconds.
- The  icon will no longer be illuminated.

OPERATING INSTRUCTIONS





Sabbath mode

In Sabbath mode alarms, lights and displays are deactivated for 80 hours.

- To activate Sabbath mode press and hold ,  and  buttons for 4 seconds.
- The  icon on the **internal** control panel will be illuminated.

Once in Sabbath mode:



- The interior light will not turn on when the refrigerator is opened.
- The door alarm will not operate.
- The display will not illuminate, except the Sabbath mode icon.
- The **internal** and **external** control panel will not operate.
- Sabbath mode will automatically deactivate after 80 hours.

- To deactivate manually, press and hold ,  and  for 4 seconds.
- The  icon on the **internal** control panel will no longer be illuminated.

Note: If power is turned off the refrigerator will automatically continue in Sabbath mode once power is restored.

Bottle Chill



This function allows you to chill your beverages rapidly in the freezer without the worry of forgetting them. The timer is set for 15 minutes however the time taken to chill depends on the size of your beverage. If after 15 minutes your beverage is not cold enough, simply place it back in the freezer and reset the 'Bottle Chill' function.



- To activate, press the  button on the **internal** display. The 'Bottle Chill' light above the button will be illuminated when the function is activated. For Ice & Water models the  icon will also be illuminated on the **external** display.
- An alarm will sound after 15 minutes has elapsed reminding you to remove your beverage from the freezer.

To silence the alarm - with internal Ice maker models:

Open the fresh food compartment door and press the  button on the **internal** control panel.



To silence the alarm - with Ice & Water models:

Open the fresh food compartment door and press the  button on the **internal** control panel or press the  button once on the **external** display.

- To deactivate 'Bottle Chill' before 15 minutes has elapsed, press the  button on the **internal** control panel. When 'Bottle Chill' is deactivated the light above the button will no longer be illuminated, and the  icon is not visible on the **external** display (Ice & Water models only).
- If you would like your beverage colder, place it back into the freezer and reset the 'Bottle Chill' function.

Fast Freeze





We have created the 'Fast Freeze' feature to help your get the best possible results when freezing fresh food. 'Fast Freeze' boosts the freezing speed by dropping the freezer to its coldest temperature for 12 hours, which helps to ensure vital freshness, texture and taste are retained during the freezing process.

- To activate, press the  button on the **internal** display. The 'Fast Freeze' light above the button will be illuminated when the function is activated.
- To deactivate before the 12 hours has elapsed, press the  button again. When 'Fast Freeze' is deactivated the light above the button will no longer be illuminated.
- For best results we recommend that you activate the function before it is required eg before grocery shopping. Alternatively, activate it when placing food in the freezer.

SPECIAL FUNCTIONS

Ice Boost

This function is designed to be used for times when you require more ice eg when you are having a party. The 'Ice Boost' function will increase ice production up to 30%* from standard ice making and deactivates automatically after 24 hours.

- When you first turn on your ice maker, the 'Ice Boost' function will be off.
- To turn this function on, press the  button. The light above the  button will be illuminated when the 'Ice Boost' function is on.
- To manually deactivate this feature press the  button again. The light above the  button will no longer be illuminated.
- Activating the 'Ice Boost' function will automatically turn ON ice maker.
- Deactivating ice maker will automatically deactivate the 'Ice Boost' function.

Door alarms

- If the fresh food compartment door is left open the alarm will beep after 90 seconds, and if the freezer door is left open the alarm will beep after 60 seconds.
- While either door remains open, subsequent beeps will sound every 30 seconds for 5 minutes.
- A continuous alarm will sound if either of the doors have been left open for 5 minutes or longer and the interior compartment light(s) will turn off. The alarm will stop only when the door(s) is closed.

Note: If 'Alarm Mute' has been activated the door alarms will be silenced for 20 minutes. After 5 minutes of the doors being left open the compartment light will turn off however the normal door alarms will be suspended. The light above the  button will illuminate to indicate that the appliance is in this mode.

*Dependent on your current temperature settings.

EXTERNAL DISPLAY (ICE & WATER MODELS ONLY)

The **external** display enables you to lock the water dispenser, indicates to you when 'Bottle Chill' is activated and when your water filter requires changing.

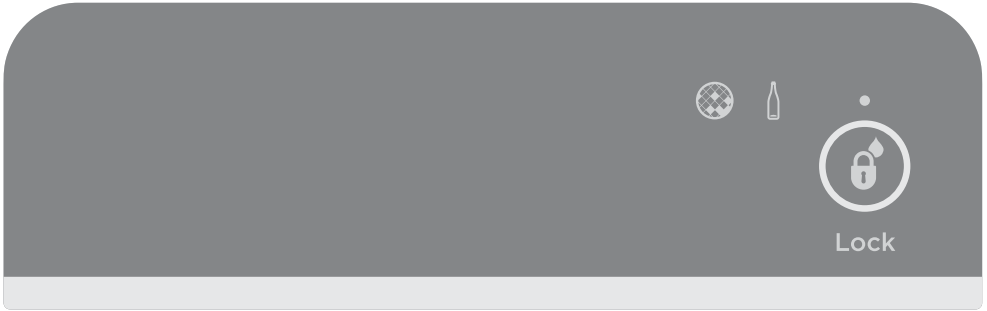

EXTERNAL DISPLAY FEATURES



Lock

Dispenser lock button and LED light

Locks/unlocks the water dispenser. When locked the LED above the button will illuminate.



Bottle Chill indicator

Icon will illuminate indicating when 'Bottle Chill' is activated and flashes when beverage is ready.



Filter change indicator

Icon will illuminate indicating when water filter requires changing.

USING YOUR WATER DISPENSER (ICE & WATER MODELS ONLY)

TO ENSURE YOUR APPLIANCE OPERATES CORRECTLY PLEASE REFER TO THE INSTALLATION INSTRUCTIONS BOOKLET SUPPLIED WITH THIS PRODUCT.

Before using your water dispenser

Ensure your ice and water system has been correctly installed by following the installation instructions booklet supplied.

To flush the water filtration system:

- Ensure your refrigerator is switched on, and the isolation faucet has been connected and turned on.
- Run your water dispenser until water dispenses, this will displace trapped air in the water tank and filter system. This will take at least 2 minutes. Once water has dispensed, rest the dispenser pad for 2 minutes.
- Dispense and discard 4qt (4L) of water, then rest the dispenser pad for a further 2 minutes.
- Dispense and discard a further 4qt (4L) of water. Failure to do this will result in excessive dripping from your dispenser.
- Please note, once installation is complete a few drips may appear out of the dispenser over the next few days to clear the remaining trapped air.
- Ensure your refrigerator has cooled for at least 2 hours before use.



Water dispenser

You are now ready to enjoy water from your water dispenser.

Dispensing

- Your water dispenser has been designed for one-handed operation.
- To dispense water, gently press the dispensing pad using a glass or container.
- To stop the flow of water, simply pull your glass away from the dispensing pad.
- Please remember that pressing very hard against the dispensing pad will not encourage the dispenser to operate faster or produce greater quantities of water.



IMPORTANT!

To avoid damage to property or personal injury do not put hands, fingers or objects up the dispenser opening.



Dispenser lock

The dispenser lock located on the **external** display can be activated to prevent water from being dispensed. This is useful when you are cleaning the **external** display or when there are small children around.

- To activate dispenser lock press the  button for 4 seconds. The LED above the button will illuminate.
- When the dispenser pad is pressed several beeps will sound indicating to the user that water cannot be dispensed.
- To deactivate dispenser lock and allow water dispensing, press the  button for 4 seconds. The LED above the button will no longer illuminate.

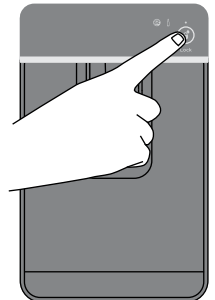

Dispenser lock

WATER FILTER

All the water supplied to your refrigerator is filtered through a filter cartridge, this helps remove unwanted impurities and is located behind the kickstrip grille. To maintain water quality we recommend replacing the filter cartridge every 6 months.

Note: the unit will not dispense water or ice if the filter is not fitted.

- When the filter cartridge requires replacing, the filter change icon  will illuminate on the **internal** control panel and/or **external** display. The icon will flash as a reminder on the **external** display whenever water is dispensed.
- Replacement filter cartridges (part number: 81099) can be purchased online through www.fisherpaykel.com or www.dcsappliances.com, or by calling the Customer Care Center.

IMPORTANT!

- **To avoid serious illness or death, do not use the water filter where water is unsafe or of unknown quality.**
- **If the water filtration system has been allowed to freeze, replace the filter cartridge and flush the water system following the instructions on the previous page.**
- **The water filter cartridge needs to be changed when the filter change icon illuminates on the internal control panel and external display.**

To remove the old water filter cartridge

RS36A72 models only

- ① Remove kickstrip grille by inserting fingers into the left and right square openings on the grille. Pull towards you. The filter is located on the left-hand side.
- ② Pull freezer drawer slightly open in order to fit filter cartridge tool.
- ③ Align the filter cartridge tool to the filter and turn 90° anti-clockwise to loosen, as shown on the right.
- ④ Pull the filter cartridge tool and filter towards you to remove.
 - When the filter is removed a few drops of water may be present. This is quite normal.
 - Discard the old filter.

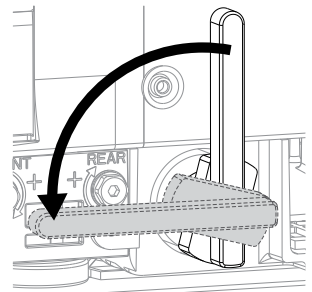

Disengaging filter cartridge

RS36A80 and RS36W80 models only

- ① Remove the air flow divider by pulling towards you.
- ② Remove the top kickstrip grille by inserting fingers into the left and right hand square openings on the grille. Pull towards you. The filter is located on the left-hand side.
- ③ Pull freezer drawer slightly open in order to fit filter cartridge tool.
- ④ Align the filter cartridge tool to the filter and turn 90° anti-clockwise to loosen, as shown above.
- ⑤ Pull the filter cartridge tool and filter towards you to remove.
 - When the filter is removed a few drops of water may be present. This is quite normal.
 - Discard the old filter.

WATER FILTER

To install new filter cartridge

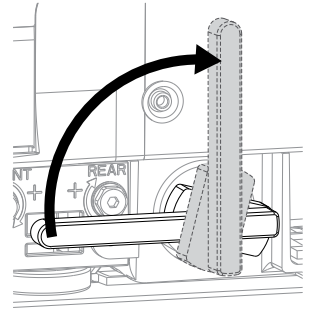

- ① Pull freezer drawer slightly open in order to fit filter cartridge tool. Remove the red protective cap on the spigot head. Align the filter cartridge tool over the filter.
- ② Insert the filter cartridge and tool into the bottom left of the product, as shown on the right.
- ③ Firmly push the cartridge in until the filter head cannot be pushed any further. Turn 90° clockwise to tighten as shown on the right.
- ④ Remove filter cartridge tool and close freezer drawer. Replace kickstrip grille by aligning securing hooks. Push grille firmly onto product until it clips securely.
RS36A80 and RS36W80 models only, replace air flow divider. Align the divider underneath the grille tabs indicator and clip onto the vanes of the bottom grille.
- ⑤ Reset the filter change icon on the display, this will remind you when the filter next requires replacing. Please refer to the next page for activation.
- ⑥ Flush the water filter of any trapped air, harmless carbon fines and to also check for leaks. Dispense 4qt (4L) of water and discard.
- ⑦ A few drops of water may appear out of the dispenser over the next few days as the remaining trapped air is cleared.



Engaging filter cartridge



To reset the filter change icon

We recommend the water filter be used from the time of installation, and the change filter icon be reset only when a replacement is installed. Do not reset the change filter icon before the filter is changed or the filter monitoring will be inaccurate.

- To reset, press the  and  buttons for 4 seconds on the **internal** control panel.
- The filter icon  on the **internal** control panel and/or **external** display will no longer illuminate.

To disable the filter change icon

If the change filter icon is disabled you will not be reminded of when to next change your filter cartridge. We only recommend disabling this function when no filter cartridge is fitted.

- To disable, press the ,  and  buttons for 4 seconds.
- We recommend that you do not disable the filter change icon if you have a filter cartridge fitted to the connection.

IMPORTANT!

- **The rate of water flow through the water dispenser can slow down as the filter cartridge accumulates any sediment which may be present in the water supplied to your home. This varies depending upon your local water quality, which may require your filter cartridge to be changed more frequently.**
- **In cases of excessively reduced filter life we recommend that you consult a local plumber or your water supplier for advice on suitable filtration requirements for the water supplied to your home.**
- **Filter replacement is the consumer's responsibility and will not be covered by the Manufacturer's Warranty except in the case of faulty parts or materials within the filter cartridge.**
- **If the water has not been dispensed for some time or water has an unpleasant taste or odor, flush system by dispensing 4qt (4L) of water.**
- **If unpleasant taste or odor persists, you may wish to fit a new filter cartridge.**



USING YOUR ICE MAKER

TO ENSURE YOUR APPLIANCE OPERATES CORRECTLY PLEASE REFER TO THE INSTALLATION INSTRUCTIONS BOOKLET SUPPLIED WITH THIS PRODUCT.

Ice On/Off

Your automatic ice maker is designed to dispense ice cubes into the ice storage bin below until it senses the bin is full. If you require more ice, the storage bin can be removed and ice will dispense into the top freezer bin.

Before you start using your automatic ice maker

- When you first turn your refrigerator on after installation, the ice maker will be off.
- To activate your automatic ice maker, press the 'Ice On/Off'  button once. The LED light above the  button will illuminate indicating ice maker is on.
- Press and hold the , **-** and **+** together for 4 seconds then close the doors. The ice tray will flip twice and empty the water into the bin below. The ice tray will flip only after the doors are closed.
- Force another cycle, this step helps remove any manufacturing and transportation dust in the ice tray.
- Empty the water and correctly replace the bin, ensuring the scoop is located at the front of the bin.
- Once your ice maker is in operation, discard the first 24 hours of ice harvest. This will flush away any impurities in the water line and ensure that you get the best quality ice. We recommend that you also do this after vacations or extended periods of not using ice.
- We recommend that you turn the ice maker off if:
 - The water supply is going to be off for several hours,
 - The ice storage bin is to be removed for a period of time,
 - You are going on holiday/vacation.

USING YOUR ICE MAKER

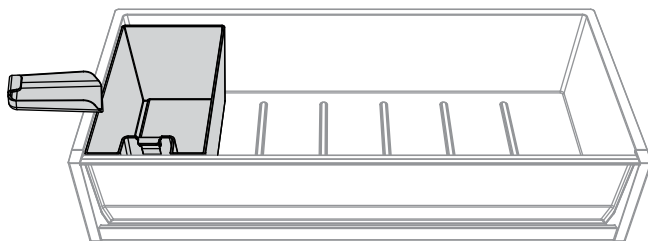

Ice storage bin and scoop

Information about your automatic ice maker

- Your product comes with an ice storage bin located inside the top freezer bin, and a hygienic scoop for ice. This scoop provides hygienic access to clean, clear ice cubes.
- Your automatic ice maker will produce approximately eight cubes of ice every 3 – 4 hours, depending on the freezer compartment temperature and the number of door openings.
- The ice cube tray will fill with filtered water.
- When cubes are frozen, they will be dispensed from the ice tray and into the ice storage bin below.
- Ice making will continue until the storage bin is full, and only resume once you start to use the stored ice.
- When the 'Ice Boost' function is activated, ice production will increase up to 30%* from standard ice making. This function automatically deactivates after 24 hours.
- If large amounts of ice are required, remove the ice storage bin and allow ice to fill the top freezer bin.
- For maximum ice storage, level the stored cubes with the ice scoop.
- If ice is not used often, old cubes will become cloudy, taste stale, will shrink and may stick together. Empty the ice storage bin periodically and wash in lukewarm water. Dry thoroughly and place back into the correct position.

IMPORTANT!

- **Avoid contact with the moving parts of the ice maker ejector mechanism, and do not place your fingers on the automatic ice making mechanism while the refrigerator is in operation.**
- **Do not use ice cubes that may have become discolored, usually with a green-blue color. If such discoloration is noted, discard the ice cubes and contact your Fisher & Paykel trained and supported service technician.**
- **Ensure the ice maker is connected to the filter cartridge and to a potable water supply only.**
- **Installation of the water connection to the ice maker must be completed by a qualified service technician or a qualified plumber.**

*Dependent on your current temperature settings.

Fruit and vegetable bins with humidity control lids

- Your refrigerator has two fruit and vegetable bins and one slim bin. These bins are fitted with humidity control lids and settings for either fruit or vegetable storage.
- The unique humidity control lid functions to seal the bins and provide a humid microclimate to extend the storage times of fruit and vegetables.
- During times of high humidity the lid also functions to prevent condensation from dripping onto the fruit and vegetable by retaining this moisture in the lid's specially designed grooves.

Fruit and vegetable bins with humidity slide

- All fruit and vegetable bins have an adjustable humidity slide which enables you to choose a fruit or vegetable setting depending on your storage needs.
- If there is too much water in the bins (due to high humidity), the control can be adjusted towards the setting with fewer drips (fruit setting, 🍏) and/or the water can be wiped dry when required.
- Remember a small amount of water in the bins is beneficial for fruit and vegetable storage.
- When storing vegetables; which are ethylene-sensitive produce such as lettuce, spinach, broccoli, cabbage, carrots. We recommend using the vegetable setting, 🥕.
- When storing fruits which are generally high ethylene producers; such as citrus fruits, stone fruits and some tropical fruits, we recommend using the fruit setting, 🍏.
- When storing a combination of fruit and vegetables, we recommend adjusting the humidity slide to the center.
- Ideally store whole fruits and vegetables without external packaging, if possible, and in separate bins. Separating fruit and vegetables will prevent ethylene-sensitive produce from ripening too quickly, and help extend their storage life.

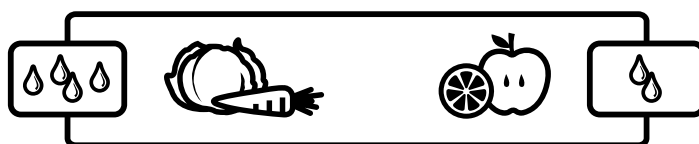

Humidity control graphic

Slim bin

The slim bin provides the ideal environment for long vegetables which may not fit in the fruit and vegetable bins. Alternatively the bin can conveniently be used for deli items, beverages or for defrosting foods.

Single bottle holders

- The bottle holders can be used to store a variety of bottles.
- To position the bottle holder in your refrigerator, simply place the holder along the length of any shelf.
- If you are not using all or some of the bottle holders, the unused bottle holders can be stacked up on top of one another so they do not take up unnecessary shelf space.
- Bottles are best stored with the neck of the beverage facing the front of the refrigerator.
- Additional bottle holders can be purchased by calling your Fisher & Paykel Customer Care Center, or online at www.fisherpaykel.com or www.dcsappliances.com.

Cantilever glass shelves - half width and full width

- The cantilever glass shelves have been designed with strength and versatility in mind.
- Half-width and full-width shelves can be removed by firmly grasping the front of the shelf with two hands, tilting the front of the shelf upwards to dislodge the shelf hooks from the back support lugs, then pulling towards you. They can then be positioned at heights to suit your storage requirements.
- The half-width shelves can be positioned side by side, best when storing large items such as platters.
- Maximize the storage space when storing items of varying heights by positioning the half-width shelves at different levels.

Door shelves

- The top shelves are dairy compartments, designed to store butter and cheeses.
- The middle shelves are designed for general items, condiments and drinks.
- The bottom aluminium extrusion shelf is designed to store large bottles or those you require frequent access to. This shelf is fitted with a moveable and removable divider for better organization and bottle stability.
- Clear windows give ultimate visibility to what is being stored in the door shelves.

CLEANING CARE - EXTERIOR

Exterior

Stainless steel exterior doors

- It is important when cleaning the exterior door surface of your refrigerator, to use only liquid dishwashing detergent dissolved in warm water and a soft lint-free cloth.
- Rinse with clean water and dry with a clean, lint-free cloth.
- For DCS door panels only, a stainless steel cleaner may be used. Some brands of cleaners are more harsh than others and may cause parts to discolor and corrode. Read and follow manufacturer's instructions carefully.

Other exterior surfaces

- Clean all other exterior surfaces with liquid dishwashing detergent dissolved in warm water and a soft lint-free cloth.
- Rinse with clean water and dry with a clean, lint-free cloth.
- For custom door panels follow manufacturers cleaning instructions.

Door gasket

- It is recommended to clean the magnetic door gasket every three months with an old toothbrush, and liquid dishwashing detergent dissolved in warm water.
- Gasket must be kept clean and pliable to assure a proper seal.
- Petroleum jelly applied lightly on the hinge side of the gasket will keep the gasket pliable and assure a good seal.

External display and water dispenser (Ice & Water models only)

- To prevent water from dispensing when you clean, the 'Lock' function can be activated.
- To activate press and hold the **Lock** button for 3 seconds. The LED above the button will illuminate.
- Clean the pad and interface panel with a damp, soft lint-free cloth.

Drip tray (Ice & Water models only)

- ① Dislodge the drip tray from the dispenser panel (**A**).
- ② Pull the two halves of the tray apart (**B**).
- ③ Clean with liquid dishwashing detergent dissolved in warm water and a soft lint-free cloth.
- ④ Rinse with clean water and dry with a clean, lint-free cloth.
- ⑤ Securely clip the two halves together.
- ⑥ Reinsert the drip tray back into the dispenser panel.

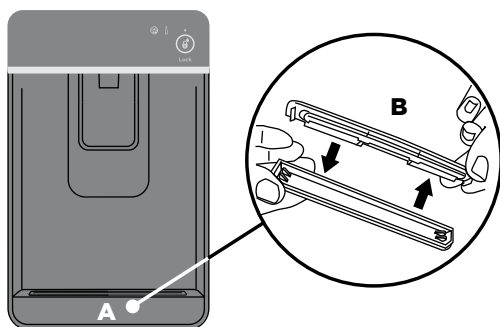

Cleaning the drip tray

CLEANING CARE - EXTERIOR

Kickstrip grilles and kickstrip filter

Your refrigerator is fitted with a kickstrip grille and filter to protect the internal working components. We recommend cleaning the grille and filter in conjunction with changing your water filter cartridge (every 6 months).

- To maximize operating efficiency keep ventilation openings clear of obstructions by regularly vacuuming the flooring in front of your appliance.
- More frequent cleaning may be necessary for dusty homes or those with pets shedding hair.

RS36A72 models only

To clean the kickstrip grille and kickstrip filter:

- ① Remove the kickstrip grille by inserting fingers into the left and right square openings on the grille. Pull towards you (**A**).
- ② To remove kickstrip filter, insert fingers into the left and right square openings on the filter. Pull towards you (**B**).
- ③ Clean both components with liquid dishwashing detergent dissolved in warm water and a soft lint-free cloth.
- ④ Rinse with clean water and dry with a clean, lint-free cloth.

To replace kickstrip filter and kickstrip grille:

- ① To replace kickstrip filter, align filter tabs onto the rails and push to the rear until it clips securely (**C**).
- ② To replace kickstrip grille, ensure spacers on the inside of the kickstrip are positioned correctly. Align securing hooks then firmly push grille onto product until it clips securely (**D**).

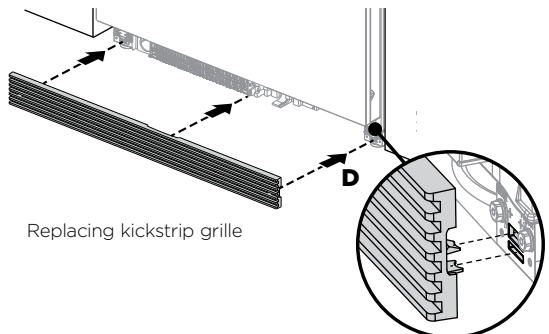
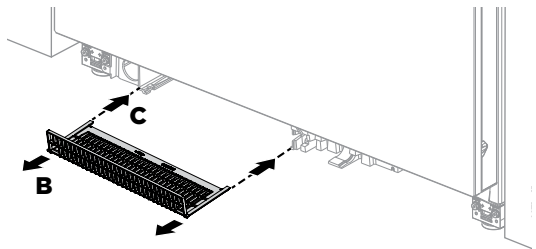
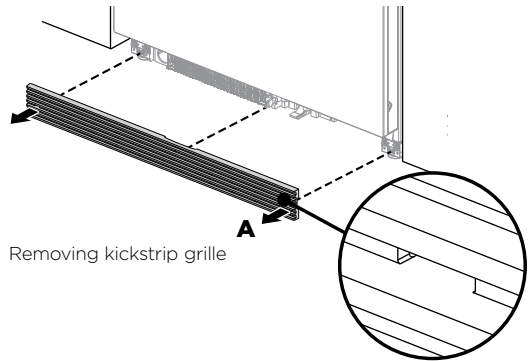

CLEANING CARE - EXTERIOR

RS36A80 and RS36W80 models only

To clean the bottom kickstrip grille and kickstrip filter:

- 1 Remove the air flow divider by pulling towards you (A).
- 2 To remove the top kickstrip grille, insert fingers into the left and right square openings on the grille. Pull towards you (B).
- 3 To remove kickstrip filter, insert fingers into the left and right square openings on the filter. Pull towards you. Refer to 'Removing and replacing kickstrip filter' drawing.
- 4 Clean both components with liquid dishwashing detergent dissolved in warm water and a soft lint-free cloth.
- 5 Rinse with clean water and dry with a clean, lint-free cloth.

To replace kickstrip filter and kickstrip grille:

- 1 To replace kickstrip filter, align filter tabs onto the rails and push to the rear until it clips securely.
- 2 To replace top kickstrip grille, align securing hooks then firmly push grille onto product until it clips securely (C).
- 3 To replace air flow divider, align the divider underneath the grille tabs indicator and clip onto the vanes of the bottom grille (D).

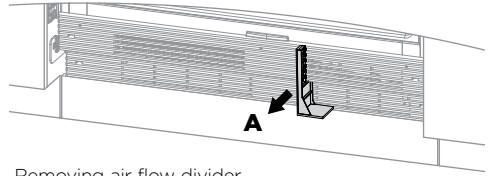

Removing air flow divider

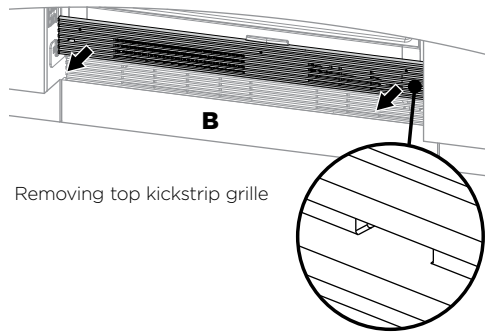

Removing top kickstrip grille

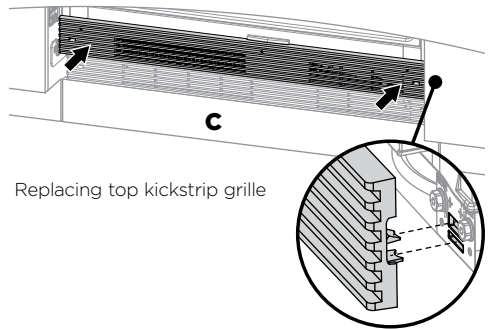

Replacing top kickstrip grille

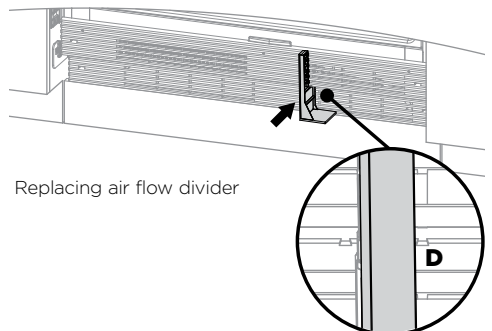

Replacing air flow divider

CLEANING CARE - INTERIOR

Interior

- It is important to keep the interior of the refrigerator clean to help prevent food from becoming contaminated during storage.
- The amount and types of food stored determines how often cleaning should be carried out in the refrigerator (ideally once every 1 - 2 weeks).
- For ease of cleaning, empty the refrigerator first and remove all glass shelves, door shelves and storage bins.
- Wipe all interior surfaces, including all door shelves, using only liquid dishwashing detergent dissolved in warm water or baking soda dissolved in warm water (add 1tsp of baking soda to every 16.9oz (500ml) of water) and a soft lint-free cloth. Rinse with clean water and dry with a clean, lint-free cloth.
- To help remove “old stale refrigerator” smells add a few drops of vanilla essence or vinegar to the water before cleaning.
- Do not use harsh chemicals, abrasives, ammonia, chlorine, bleach, concentrated detergents, solvents or abrasive scouring pads on any part of your refrigerator. SOME of these chemicals may dissolve, damage and/or discolor the interior of your refrigerator.

Cantilever glass shelves

- Clean with liquid dishwashing detergent dissolved in warm water and a soft lint-free cloth.
- Rinse with clean water and dry with a clean, lint-free cloth.

- ① To remove glass shelves hold the front and back edge of the shelf firmly.
- ② Push the shelf up vertically to dislodge from back support lugs.
- ③ Pull the shelf towards you.

Single bottle holders

- Clean with liquid dishwashing detergent dissolved in warm water and a soft lint-free cloth.
- Rinse with clean water and dry with a clean, lint-free cloth.

Humidity control system

- When cleaning the glass shelf above the fruit and vegetable bins, we recommend using only liquid dishwashing detergent dissolved in warm water and a soft lint-free cloth. Rinse with clean water and dry with a clean, lint-free cloth.
- When cleaning the humidity control lid (attached to the underside of the glass shelf), we do not recommend disassembling the parts. To clean, simply wipe the grooves of the lid with a damp, lint-free cloth.

CLEANING CARE - INTERIOR

Fruit and vegetable bins and slim bin

When cleaning use only liquid dishwashing detergent dissolved in warm water and a soft lint-free cloth. Rinse with clean water and dry with a clean, lint-free cloth.

- ① To remove a bin, extend the bin on its runners, making sure the bin is empty.
- ② With hands on either side of the bin corners, firmly push the bin upwards to dislodge from securing tabs.
- ③ Pull the bin towards you to remove. Push both runners back into the refrigerator.
- ④ To replace, extend the runners and place the bin on top of the runners.
- ⑤ Push the bin slowly onto the runners until you feel it clip onto the runners. Ensure the bin tabs are clipped securely onto the runners before use.

IMPORTANT!

Runners are pre-lubricated to aid opening and closing, and will not need to be re-lubricated during their life. Do not attempt to clean the grease from the runners, as this will affect their ability to function. Do not immerse the runners in water.

Freezer bins and freezer tray

We do not recommend the removal of freezer bins and the freezer tray. To clean, simply wipe clean with a soft lint-free cloth.

Ice storage bin

- When going on vacation/holiday we recommend cleaning your ice bin and discarding any old ice in the bottom of the bin(s) before leaving.
- When cleaning use only liquid dishwashing detergent dissolved in warm water and a soft lint-free cloth. Rinse with clean water and dry with a clean, lint-free cloth.
- When replacing the bin ensure that the ice scoop is positioned at the front.
- We do not recommend you cleaning the ice maker components, but it is important to regularly clean your ice bin and discard any old ice in the bottom of the bin(s).
- When going on vacation/holiday we recommend you turn the ice maker OFF on the **internal** control panel and shut off the water supply to the refrigerator (if accessible). Refer to 'Using your ice maker' section.
- On your return, turn on the ice maker and discard the first 24 hours of ice harvest. Refer to 'Using your ice maker' section.

Ice & Water models only

On your return turn on the water supply to the refrigerator (if accessible). Flush water system by dispensing 4qt (4L) of water and discarding. This will ensure the tank is refilled with fresh water.

STORING FOOD IN YOUR REFRIGERATOR

Your refrigerator is designed to help prolong the storage life of fresh and cooked foods. Each compartment's specialized zones along with a constant cold temperature delays the onset of food spoilage – particularly the metabolic growth of bacteria, molds and yeasts causing chemical and physical changes.

General fresh food care

The quality of food before being placed in the refrigerator is critical to successful storage. This determines how long foods stay fresh for, and how long they can be kept refrigerated.

For best results:

- Only select foods of high quality and freshness.
- Only purchase foods you plan to use within the recommended storage time. If extra is purchased, plan to freeze the foods.
- Before storing foods, ensure they are wrapped in suitable packing material.
 - This will prevent food from dehydrating, deteriorating in color or losing flavor and will help maintain freshness. It will also prevent odor transfer.
 - Fruit and vegetables do not require wrapping and are recommended to be stored in the vegetable bins of the refrigerator.
- Ensure perishable foods are stored in the refrigerator immediately after purchase; this will prolong their shelf life. Storing at room temperature increases the rate of deterioration.
- Avoid placing food directly in front of air outlets; this may freeze foods and decrease the efficiency of cold air in the refrigerator to maintain safe food storage.
- Keep door openings to a minimum and do not open unnecessarily.
- Ensure hot foods and drinks are cooled sufficiently before placing them in the refrigerator. Hot foods may cause other foods to warm to unsafe temperatures. If in contact with plastic components of your refrigerator, hot containers may cause damage. Additionally hot foods may cause an increase in energy consumption.
- Ensure raw and cooked foods are stored in separate air tight containers to prevent cross contamination. We recommend storing raw foods on the bottom shelf of the refrigerator.
- Keep the refrigerator clean by frequently wiping the inside walls and shelves (refer to 'Cleaning care' section).
- Pay attention to the quality of foods in your refrigerator.
 - Discard food that show signs of spoilage (by visual inspection and odor).
 - Pay particular attention to protein rich foods (meats, fish and poultry) as some deteriorate faster than others.
 - Use foods within the recommended storage dates.

Dairy foods and eggs

- We recommend high-in-fat dairy products eg butter, cheeses be stored in the covered door shelves of the refrigerator as these foods are easily tainted by strong odorous foods.
- We recommend eggs be stored in the covered door shelves of the refrigerator or in their carton as the porous egg structure is susceptible to absorbing odors.
 - When using eggs in baked goods it is ideal to use room temperature eggs. Be sure to remove the required eggs 2 hours beforehand.
- Ensure pre-packed dairy products stamped with recommended 'use by/best before/best by' dates are consumed within the recommended storage time.
- Ensure dairy products are stored in their original packaging until ready to consume. Once opened, package any remaining in suitable packing material eg cling film to avoid the transfer of odors.

STORING FOOD IN YOUR REFRIGERATOR

Precooked foods and leftovers

- Ensure cooked foods are stored in suitable covered containers, this will prevent foods from drying out.
- Keep for only 1 – 2 days.
- Reheat leftovers only once and until steaming hot.

Red meats

- Ensure raw and cooked foods are stored in separate air tight containers to prevent cross contamination from the loss of raw meat juices.
- Ensure delicatessen meats are consumed within the recommended storage time. These can be stored in the slim storage bin if you want to keep separate.

Poultry

- Keep whole poultry or poultry pieces in the original packaging until just before use.
- We recommend placing the packaged poultry in a dish and storing on the bottom shelf of your refrigerator to prevent any potential spills from contaminating other foods.
 - Whole poultry or poultry pieces should only be stuffed right before cooking. Preparation in advance may result in food poisoning.
- Ensure stuffing is removed from cooked poultry, and both are sufficiently cooled then covered before storing in the refrigerator.

Fish and seafood

- Whole fish and fillets are ideally consumed on the day of purchase. Ensure they are stored in suitable covered containers or packaging, this will prevent foods from drying out and transferring odors.
- If storing overnight or longer, ensure whole fish is cleaned and dried before covering and storing, preferably on a bed of ice, in your refrigerator.
- Ensure fish fillets and other seafood are treated the same way.
- Keep shellfish chilled at all times and consume within 1 – 2 days.

Fruit and vegetables

- Not all fruit and vegetables are suitable for prolonged refrigeration storage at temperatures below 41°F (5°C).
 - Undesirable physical and chemical changes will result from low temperature storage, such as loss of rigidity, browning, increased rate of deterioration and potential loss of flavor.
- Try to store fruit and vegetables separately, as each emit different ethylene levels – the cause of ripening.
- Ensure fruits are not washed before storage, this increases the rate of deterioration.
- Ensure vegetables are sorted and damaged parts are discarded.

Beverages

- Ensure beverages are stored tightly on the door shelves of the refrigerator. This prevents the bottles from tipping or falling out when the refrigerator door is opened. Otherwise use bottle holders to store beverages on the shelves.
- The door shelves are held by support lugs and are fully adjustable to suit your storage requirements.

STORING FOOD IN YOUR FREEZER

Freezing and storing foods at temperatures -0.4°F (-18°C) or colder helps retain the physical quality and nutritional value of foods. Low temperatures inhibit the growth of bacteria, molds and yeasts, thereby restricting chemical and physical reactions to extend the food's storage life.

General fresh frozen food care

Successful freezing depend on the foods' quality, packaging and proportions. We recommend freezing foods fast to maintain moisture content and to prevent the formation of large ice crystals.

For best results:

- Only select foods of high quality and freshness.
- Ensure foods are packaged in suitable packaging material before freezing.
- Ensure foods freeze as quickly as possible and in small quantities. Do not attempt to freeze more than 2.2 pounds (1kg) of meat per 6.6gal (25L) of freezer storage volume.
 - Freezing in smaller quantities helps retain the nutrient qualities and appearance of the food as best as possible.
- When freezing many foods at once, we recommended activating the 'Fast Freeze' function 2 hours beforehand.
 - Ensure fresh food to be frozen does not come into contact with already frozen foods. This will cause frozen foods to start defrosting.
- When freezing foods containing liquids or semi-solids ensure there is a 1 - 2" (20 - 50mm) head space to allow the foods to expand as they freeze.
- Keep door openings to a minimum and do not open unnecessarily.
- Ensure all air is removed from food packaging. This will avoid large formation of ice crystals and prevent freezer-burn on foods. The formation of small ice crystals is normal.
- Ensure hot foods and drinks are not placed directly into the freezer. Hot containers may damage shelves and walls of the refrigerator, increase energy consumption and cause already frozen foods to defrost.
- Ensure there is a constant turnover of foods. User older items of food first and do not exceed the recommended storage times. See table below.
- Ensure partially or fully defrosted foods are never re-frozen. Defrosted foods can only be refrozen after they have been cooked.

Recommended freezer storage times for freshly frozen foods

These times should not be exceeded.

MONTHS	TYPE OF FOOD STORED
1	Bacon, casseroles, milk
2	Bread, ice cream, sausages, pies, prepared shellfish, oily fish
3	Non-oily fish, shellfish, pizza, scones and muffins
4	Ham, baked goods, beef and lamb chops, poultry pieces
6	Butter, blanched vegetables, whole eggs and yolks, cooked crayfish, raw minced meats
12	Dried fruits or fruit in syrups, egg whites, raw beet, whole chicken, raw lamb, fruit cakes

STORING FOOD IN YOUR FREEZER

Precooked foods and leftovers

- Ensure cooked food are stored in suitable covered containers and away from raw frozen foods.
- Not all foods are suitable for freezing; some separate on defrosting such as cooked egg whites, custards and cream fillings, meringue toppings, milk porridges, gelatin or jelly-like dishes and salad dressings.

Red meats, poultry and game

- We recommend selecting lean meats as opposed to fatty meats. These have a lower fat content, freeze much better and can be stored longer.
- When packaging meats (chops, steaks, cutlets) separate with sheets of plastic freezer film, then package all together. This prevents the meats forming into a solid block on freezing.
- Ensure stuffing is removed from poultry prior to freezing. Whole poultry or poultry pieces should only be stuffed right before cooking. Preparation in advance may result in food poisoning.

Fish and seafood

Ensure whole fish are rinsed inside and out with cold running water to remove loose scales and dirt, then dried and packaged before storing in the freezer.

Fruit

- Choose high quality, mature, and ready to eat fruits. Only select fruit varieties recommended for freezing.
- Most packaged fruits can be stored for 8 - 12 months. Fruits packed in syrup are ideal for desserts, while fruits packed without sugar are better used for cooking.

Vegetables

- Not all vegetables are suitable for freezing eg lettuce, radishes, and onions. Only select mature and ready-to-eat vegetables recommended for freezing.
- Ensure vegetables are sorted and damaged parts are discarded.
- We recommend blanching vegetables before freezing. This technique inhibits vegetable enzymes and helps preserve the color, flavor and nutritional value of the vegetables without chemical or physical damages.
- To blanch, boil vegetables in boiling water for 2 - 4 minutes, remove and cool quickly in ice-cold water. Drain well then package.

Beverages

- We recommended cooling carbonated beverages only when the 'Bottle Chill' function is active.
- Do not store carbonated drinks without this function in the freezer, failure to remove beverages could lead to freezing liquid and the likelihood of bottle/can explosion.

DEFROSTING FOOD IN YOUR REFRIGERATOR

Your refrigerator is also designed to help defrost/thaw foods in a safe manner by avoiding the growth of bacteria, molds and yeasts – major causes of food spoilage.

General defrosting food care

For best results:

- Ensure foods are defrosted in the refrigerator, microwave oven or multifunction oven.
 - Never defrost foods at room temperature, this could potentially promote the growth of bacteria and cause food poisoning even after cooking.
 - Foods can be defrosted in the slim storage drawer (where fitted) if you want to keep separate from the rest of the refrigerator.
- Ensure partially or fully defrosted foods are never re-frozen. Defrosted foods can only be refrozen after it has been cooked.

Red meats, poultry and game

- Red meat can be cooked from frozen, or from the partly or completely defrosted states. Ensure extra cooking time is given when cooking from the frozen state.
- Ensure poultry is completely defrosted before cooking and never use the frozen juices for cooking. We recommend washing your hands thoroughly to avoid the chances of food poisoning, especially salmonella poisoning.

Fish and seafood

- Ensure fish does not come into contact with other foods when defrosting in the refrigerator.
- For best results, cook from either the frozen or partly defrosted state.

Fruit and vegetables

- Defrost frozen fruits in the refrigerator. Alternatively they can be used as part of frozen desserts.
- Frozen vegetables are best cooked from their frozen state.

Refrigerator packaging materials

DO USE	DON'T USE
<ul style="list-style-type: none">• Polyethylene film/seran wrap/plastic food wrap• Heavy-duty aluminum foil• Air-tight containers with lids• Plastic freezer film• Resealable freezer bags	<ul style="list-style-type: none">• Wrapping paper/cellophane• Grease-proof/cooking paper• Permeable wraps• Plastic carrier bags• Trash bags

User warnings



Faults

In the unlikely event a fault occurs the  icon will illuminate on the **internal** control panel and an alarm will sound when the fresh food compartment door is opened.

- Please count the number of beeps made when the fresh food compartment door is opened.
- Please record the number and sequence of temperature lights displayed on the **internal** control panel and contact a Fisher & Paykel trained and supported service technician in order to repair the fault. You can do this by going online to www.fisherpaykel.com or www.dcsappliances.com, or by contacting our Customer Care Center.
- To silence the fault alarm press any button on the **internal** control panel. The  icon will remain illuminated until the fault is corrected.

Normal refrigerator sounds

ActiveSmart™ refrigerators, with their excellent energy ratings and cooling performance, can produce sounds somewhat different to your old refrigerator.

Normal operational sounds include:

- Fan air flow sound. ActiveSmart™ refrigerators have fans which change speed depending on demand. During cooling periods, such as after frequent door openings, fans circulate the cold air in the refrigerator and freezer compartments producing some air flow sound. This is quite normal.
- Cracking or popping sounds. This may occur when the automatic defrost function is operating.
- Running water sound. This is the liquid refrigerant in the system and can be heard as a boiling or gurgling noise.
- An audible hissing sound after closing the freezer door. This is due to the pressure difference between the warm air that has entered the cabinet and suddenly cooled, and the outside air pressure.
- Humming sounds. This is the compressor running and is quite normal.
- Gasket noises which can normally occur over time due to a build up of dirt and/or grime. See “Cleaning Care - Exterior” section.
- Ice maker and water dispenser sounds:
 - Motor operation (low humming).
 - Running water as the ice maker and/or water tank fills.
 - Water valve opening and closing (hissing sound).
 - Ice being loosened from the ice molding tray (cracking).
 - Ice dropping into bin (clunking).
- Other sounds may be heard for the following reasons:
 - Cabinet not level.
 - Floor uneven or weak.
 - Bottles or jars rattling on shelves.

TROUBLESHOOTING

If there is a problem with your appliance, please check the following points before contacting your local Fisher & Paykel trained and supported service technician or the Customer Care Center.

Product parts and accessories can be purchased through the Fisher & Paykel Customer Care Center, or online at www.fisherpaykel.com or www.dcsappliances.com (this service is available to selected markets only).

All models

PROBLEM	POSSIBLE CAUSES	WHAT TO DO
Appliance does not operate.	No electricity at power outlet.	Check that the plug is correctly connected and power switched on. Check another appliance at the same outlet. Check house fuse.
	Light not functioning.	The LED light cannot be serviced by the user. Contact your Fisher & Paykel dealer or trained and supported service technician.
	Refrigerator not working.	Check refrigerator is turned on at the wall or at the isolating switch.
Motor operates for long periods.	Hot weather.	Minimize door openings to allow temperature to stabilize.
	Frequent door openings.	
	Large amount of food recently added.	See 'Operating instructions' section.
	Temperature control set too low.	
Storage compartments too warm.	Doors not sealing properly.	Check that cabinet is level and gasket seals are clean. See 'Cleaning Care - Exterior' section.
	Temperature setting not correct.	See 'Operating instructions' section.
	Frequent door openings.	Minimize door openings to allow temperature to stabilize.
Large amount of food recently added.		
Food freezing in the fridge compartment.	Temperature setting not correct.	See 'Operating instructions' section.
	Food placed directly in front of air outlets.	Move chill sensitive foods away from the center back of the shelves.

TROUBLESHOOTING

All models

PROBLEM	POSSIBLE CAUSES	WHAT TO DO
Unfamiliar noises.	Cabinet not stable or level.	See 'Installation instructions' booklet.
	Freezer is defrosting.	This is normal.
Ice maker sounds.	Normal ice maker operation.	See 'User warnings and sounds' section.
Fault icon  illuminates on the internal control panel and an alarm sounds when the fresh food compartment door is opened.	-	Count the number of beeps made, and record the number and sequence of temperature lights displayed on the internal control panel. Contact Customer Care Center.
Water in the vegetable bins.	Condensation is formed by the water produced by fruit and vegetables.	A small amount of condensation is beneficial for fruit and vegetable storage.
		Wipe out water with a cloth.
Exterior of cabinet is warm.	Note: This is normal.	
Condensation on outside of refrigerator/freezer.	Not unusual during periods of high humidity.	Wipe dry.
Condensation inside fridge compartment.	Frequent or long door openings.	Minimize door openings.
	Door gasket leaking.	Check that gasket is sitting flat and sealing tightly.
	Not unusual during periods of high humidity.	Wipe dry.
Tray/bin does not slide in and out evenly.	Packaging trapped.	Check to ensure no food or packaging is trapped behind the tray/bin.
Excessive gasket noise.	May be due to a build up of dirt and/or grime.	See 'Cleaning Care - Exterior' section.
Door not closing.	An obstruction is blocking door closing.	Move obstruction.
Small or large ice cubes.	Insufficient or excessive water pressure.	Check water pressure.

TROUBLESHOOTING

All models

PROBLEM	POSSIBLE CAUSES	WHAT TO DO
Automatic ice maker does not work.	Ice maker has not been turned on.	Switch on ice maker, see 'Using your ice maker' section.
	Water supply turned off or not connected.	Connect water supply.
	Freezer compartment not working.	Contact Customer Care Center.
	Water pressure too low.	Check water pressure.
	Water line kinked/squashed.	Check water line for kinks/squashing.
	Filter clogged.	Water filter may need replacing.
	Ice cubes stick in ice bin.	Remove ice storage bin, loosen cubes and remove clumped ice. Replace ice storage bin.
Ice cubes taste tainted.	Unsealed packages may be transmitting odor/taste.	Discard ice cubes and clean ice storage bin. See 'Cleaning Care - Interior' section. Wrap or cover strong smelling foods.
	Poor taste from incoming water.	Replace filter cartridge (product parts and accessories can be purchased through our Customer Care Center (part number: 839041).
Slow ice cube freezing.	Door may have been left ajar.	Close door.
	Freezer compartment set too warm.	Turn temperature to a colder setting. See 'Operating instructions' section.
Wet ice/ ice clumping.	Low water pressure.	Check water pressure.
	Filter blocked.	Replace filter cartridge, see 'Water filter' section.
	Long freezer door openings.	Gently tap ice to unstick or, if large clumps occur, empty ice bin and make new ice.
	High ambient temperature.	
	Ice bin left out of freezer compartment for a length of time.	
Ice will stick together over time.		
Ice buildup inside freezer compartment.	Freezer door not closing tightly.	Arrange items in freezer so door can close tightly.
		Check and clean door gasket seal.

TROUBLESHOOTING

Ice & Water models only

PROBLEM	POSSIBLE CAUSES	WHAT TO DO
Water has poor taste/odor.	Refrigerator not used for an extended period.	Flush the water filtration system. Dispense and discard 4qt (4L) of water, this will ensure the water tank is refilled with fresh water.
Water dispenser does not work.	Water supply turned off or not connected.	Turn water on.
	Supply line may be blocked.	Check supply for kinks or leaks.
	On first installation there may be air in water system.	To remove air, run 4qt (4L) of water through the dispenser.
	Filter may be blocked and needs replacing.	Replace filter (product parts and accessories can be purchased through our Customer Care Center (part number: 839041)).
	Water frozen in tank.	Increase temperature to a warmer setting in fresh food compartment and freezer.
Water in first glass is warm.	Water dispenser not used for extended period.	Discard first glass of water dispensed.
	Tank capacity used recently.	Allow water time to cool.
Drips overflow drip tray.	Air trapped in tank.	Flush the water filtration system. Dispense and discard 4qt (4L) of water, then rest the dispenser pad for a further 2 minutes.
	New filter installed.	Dispense and discard a further 4qt (4L) of water. This will displace trapped air in the water tank and filter system.
Water flow rate has slowed down.	Filter cartridge is restricted. Check if filter icon is illuminating.	Replace filter cartridge (product parts and accessories can be purchased through our Customer Care Center (part number: 839041)).

SERVICE AND WARRANTY

Before you call for service or assistance...

Check the things you can do yourself. Refer to the installation instructions booklet and your user guide that:

- ① Your product is correctly installed.
- ② You are familiar with its normal operations.
- ③ You have read the 'Troubleshooting' section.

If after checking these points you still need assistance or parts or have any questions about the operation of your product, contact our Customer Care Center. If you have any questions regarding the service and warranty of your product, please refer to the Service & Warranty booklet for further details.

Contact us through our website

Fisher & Paykel: www.fisherpaykel.com/us/support/contact-us/

DCS: www.dcsappliances.com/customer-care/contact-us/

Call us toll-free, 24/7

1.888.9.FNP.USA (1.888.936.7872)

Write to us

Fisher & Paykel Appliances Inc.

695 Town Center Drive, Suite 180

Costa Mesa. CA 92626-1902

USA

email:

Fisher & Paykel: customer.care@fisherpaykel.com

DCS: usa.customer.care@fisherpaykel.com

Note: when contacting Fisher & Paykel for service or assistance, please ensure you have your purchase receipt handy.

Registration

Register your product with us so we can provide you with the best service possible.

To register your product visit our website: www.fisherpaykel.com or www.dcsappliances.com.

SERVICE AND WARRANTY

Complete and keep for safe reference:

Model _____

Serial No. _____

Purchase Date _____

Purchaser _____

Dealer _____

City _____

State _____

Zip _____

Country _____

www.fisherpaykel.com
www.dcsappliances.com

© Fisher & Paykel Appliances 2016. All rights reserved.
The product specifications in this booklet apply to the specific products and models described at the date of issue. Under our policy of continuous product improvement, these specifications may change at any time. You should therefore check with your dealer to ensure this booklet correctly describes the product currently available.

US CA

844438 A 04.16