

*Fisher & Paykel*

AeroCare clothes dryer

**Installation instructions  
and User guide**

**⚠️ WARNING!**

For your safety the information in this manual must be followed to minimize the risk of fire or explosion or to prevent property damage, personal injury or death.

- Do not store or use gasoline or other flammable vapors and liquids in the vicinity of this or any other appliance.
- WHAT TO DO IF YOU SMELL GAS
  - Do not try to light any appliance.
  - Do not touch any electrical switch; do not use any phone in your building.
  - Clear the room, building or area of all occupants.
  - Immediately call your gas supplier from a neighbor's phone. Follow the gas supplier's instructions.
  - If you cannot reach your gas supplier, call the fire department.
- Installation and service must be performed by a qualified installer, service agency or the gas supplier.

The Governor of California is required to publish a list of substances known to the state of California to cause cancer or reproductive harm and requires business to warn customers of potential exposures to such substances.

**WARNING!:** Gas appliances contain or produce substances, which can cause death, or serious illness and which are known to the State of California to cause cancer, birth defects, or other reproductive harm. To reduce the risk from substances in fuel or from fuel combustion, make sure this appliance is installed, operated, and maintained according to the manufacturer's instructions.

**In the Commonwealth of Massachusetts**

Installation of this appliance must be performed by a contractor, plumber or gasfitter who is qualified or licensed by the state.

Introduction	2
Important safety instructions	3
Installation instructions	7
The first time you turn your dryer on	48
Getting started quickly	50
AeroCare controls	54
Sorting and loading	56
Dryer cycles	58
Drying special items	63
Drying cycle options	65
Dryer operation	68
Care labels	70
Drying rack	71
Customizing dryer cycles	72
Changing pre-set options	73
Caring for your dryer	75
Before you call for service	
User warnings	78
Fault codes	78
Solving operating problems	79
Solving drying problems	82
Limited warranty	84
How to get service	86

## ***Important!***

### **SAVE THESE INSTRUCTIONS**

*The models shown in this User Guide may not be available in all markets and are subject to change at any time. For current details about model and specification availability in your country, please visit our website listed on the back cover or contact your local Fisher & Paykel dealer.*

### **Registration**

*Register your product with us so we can provide you with the best service possible.*

*To register your product visit our website:  
[www.fisherpaykel.com](http://www.fisherpaykel.com)*

## 2 Introduction

Thank you for buying a Fisher & Paykel AeroCare clothes dryer. We are very proud of this dryer and trust it will serve you well for many years.

At Fisher & Paykel we aim to provide innovative products that are simple to use, ergonomic, energy efficient and kind to the environment. Thousands of tonnes of washing and 80 years of laundry experience have been programmed into your dryer to help give you the best possible performance.

We have developed this dryer to treat your clothes with the utmost care, drying them gently, so they will look better for longer. We trust you'll enjoy the benefits of numerous drying cycles and options, and its extra large capacity.

Please take the time to read this User Guide carefully. It will help you to operate and maintain your new AeroCare dryer. Your safety and the safety of others is very important. Located on your dryer and throughout this guide are safety messages and instructions; it is important that you understand and follow them.

We hope you enjoy your new dryer.

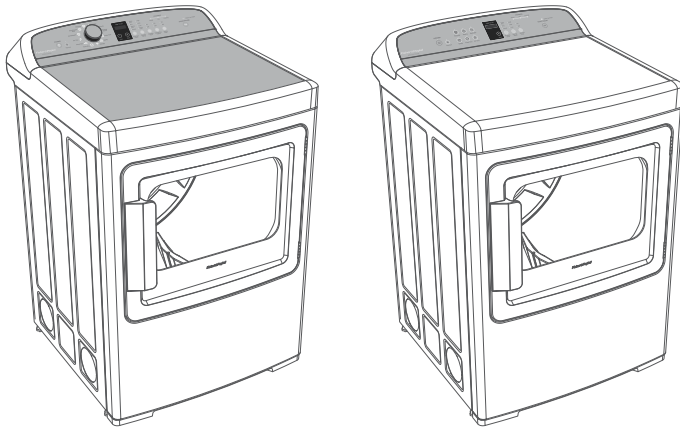

Fig.1 AeroCare dryer models

### ***Important!***

***It is important that this User Guide should be retained with your AeroCare clothes dryer for future reference. Should the appliance be sold or transferred to another owner, please ensure that the User Guide is left with the appliance. This will ensure that the new owner can familiarize themselves with the information and warnings contained within the Guide.***

## Symbols

Symbols will be used in this Guide to highlight when extra care is required. Abide by these at all times to minimize the risk of harm while operating the dryer.

It is important to always act with caution and use common sense when operating your dryer. Use only as instructed by the User Guide.



This is the safety alert symbol. This symbol alerts you to hazards that can hurt you and others, or even cause death.

The safety alert symbol and the word WARNING will precede all safety messages. This word means:



**You could be killed or seriously injured if you don't follow instructions.**

All safety messages will identify the potential hazard, tell you how to reduce the chance of injury, and tell you what can happen if the instructions are not followed.

**⚠ WARNING!****Electric Shock Hazard**

Follow the safety precautions outlined in this User Guide.

Failure to do so can result in death or electrical shock.

### *Important safety precautions*

- *Read all instructions carefully before using this dryer. Use this dryer only for its intended purpose as described in this User Guide.*
- *Installation must conform with local codes, or in absence of local codes, with the National Fuel Gas Code, ANSI Z223.1/NFPA 54 or the Canadian Natural Gas and Propane Installation Code, CSA B149.1*
- *Installation and service must be performed by a qualified or licensed contractor, plumber or gasfitter qualified or licensed by the state, province, or region where this appliance is being installed.*
- *This dryer must be properly installed and located in accordance with the Installation Instructions before it is used.*
- *This dryer, when installed, must be electrically grounded in accordance with local codes, or in the absence of local codes, with the National Electrical Code, ANSI/NFPA 70, or the Canadian Electrical Code, CSA C22.1.*
- *Do not install or store the dryer where it will be exposed to water or exposed to the weather.*
- *Connect to a properly protected, rated and sized power supply circuit to avoid electrical overload.*
- *Do not repair or replace any part of the appliance or attempt any servicing, unless specifically recommended in the published user repair instructions that you understand and have the skills to carry out.*
- *To minimize the possibility of electric shock, unplug this dryer from the power supply or disconnect the dryer at the household distribution panel (by removing the fuse or switching off the circuit breaker) before attempting any user maintenance or cleaning.*
- *When disconnecting the dryer, pull by the plug rather than the cord or junction of the cord plug, to avoid damage to the cord or junction of the cord plug.*
- *Make sure the cord is located so that it will not be stepped on, tripped over or otherwise subject to stress or damage.*
- *Do not tamper with the controls.*
- *Note: Touching the POWER button does NOT disconnect the dryer from the power supply, even though the lights are out.*
- *Do not operate this dryer if it is damaged, malfunctioning, partially disassembled or has missing or broken parts, including a damaged cord or plug.*
- *This dryer must be directly connected to an approved fixed electrical outlet. It cannot be plugged into an extension cord or an adaptor plug.*
- *Do not use the dryer if there is water on the floor near the dryer. Call an Authorized Service Agent if there is a leak.*

## ⚠ **WARNING!**



### **Fire Hazard**

**Only dry fabrics that have been washed with water.**

**Do not use a drying cycle with heat to dry articles containing foam rubber or similarly textured rubber-like materials. Only dry on the AIR DRY cycle.**

**A clothes dryer produces combustible lint and must be exhausted outdoors. Take care to prevent the accumulation of lint around the exhaust opening and in the surrounding area.**

**Do not use fabric softeners or products to eliminate static unless recommended by the manufacturer of the fabric softener or product.**

**Failure to follow these instructions can result in death or personal injury.**

**To reduce the risk of fire in a tumble dryer the following should be observed:**

- Do not place items in a tumble dryer that have previously been cleaned in, washed in, soaked in, or spot cleaned with flammable liquids or solids. They give off vapors which are a fire or explosion hazard. Highly flammable substances commonly used in domestic environments include acetone, denatured alcohol, gasoline, kerosene, some brands of spot removers and dry cleaning solvents, turpentine, waxes, wax removers, vegetable oil, fish oil, massage oil, and cooking oil.
- Do not place items exposed to cooking oils in your dryer. Items contaminated with cooking oils may contribute to a chemical reaction that could cause a load to catch fire.
- Do not leave hot oil-affected items in a pile or stack. This can prevent heat from escaping and can create a fire hazard. Oil-affected items can ignite spontaneously, especially when exposed to heat sources such as a tumble dryer. The items become warm causing an oxidation reaction in the oil. This oxidation creates heat. If the heat cannot escape the items can become hot enough to catch fire.
- Do not use a drying cycle with heat to dry items containing rubber, foam rubber, plastic or similar materials (such as padded bras, bath mats, rugs, bibs, baby pants, plastic bags, pillows etc), as these materials might melt or burn. Some rubber materials when heated can under certain circumstances produce fire by spontaneous combustion. Only dry on the AIR DRY cycle.
- Unless specifically recommended by their manufacturer, do not use fabric softeners or similar products in a tumble dryer.
- Do not store or use gasoline or other flammable gases and liquids near this or any other appliance.
- Keep the area around the exhaust opening and adjacent surrounding areas free from the accumulation of combustible materials such as lint, dust, dirt, paper, rags, chemicals etc.
- Do not store any items that may burn or melt (such as paper materials, plastics or plastic containers etc) next to the dryer.
- Clean the lint filter each time you use the dryer, before or after each load.
- The dryer must be exhausted to the outside. Carefully follow the exhausting and venting details in the Installation Instructions.
- The interior of the appliance and the exhaust duct should be cleaned periodically by qualified service personnel.

## **6** Important safety instructions

### **Use of the dryer**

- Do not allow children to play inside, on, around or with this dryer or any other appliance. Close supervision is necessary if this dryer is used near children.
- Never climb on, climb into, or stand on the dryer top, or drum, or apply weight to the door.
- Keep the floor around your dryer clean and dry to reduce the possibility of slipping.
- If your dryer is running and you want to unload or add clothes, touch START/PAUSE then open the dryer door.
- Do not reach into the appliance if the drum is moving.
- Undergarments that contain metal reinforcements should not be placed directly in the dryer. Damage to the dryer can result if the metal reinforcements come loose during drying. If you wish to dry these items use the drying rack supplied with your dryer.
- BEFORE THE APPLIANCE IS REMOVED FROM SERVICE OR DISCARDED, REMOVE THE DOOR.

***SAVE THESE INSTRUCTIONS***



## **WARNING! – Risk of fire**

Clothes dryer installation must be performed by a qualified installer.

Install the clothes dryer according to the manufacturer's instructions and local codes.

**DO NOT** install the clothes dryer with flexible plastic venting materials. If flexible metal (foil-type) duct is installed, it must be identified by the dryer manufacturer as suitable for use with clothes dryers and installed in strict accordance with the instructions found on pages 26 to 38 of these installation instructions. Flexible venting materials are known to collapse, be easily crushed and trap lint. These conditions will obstruct dryer airflow and increase the risk of fire.

The dryer must be vented to the outdoors.

Use only rigid metal 4" (102 mm) diameter ductwork inside the dryer cabinet and use only UL-listed transition ducting between the dryer and the home duct.

Do not install or store this appliance in any location where it could be exposed to water and/or weather.

To reduce the risk of severe injury or death, follow all installation instructions.

***SAVE THESE INSTRUCTIONS***

### Before you begin

Read the important safety instructions on the inside cover and on pages 3 – 6 before you start installing the dryer.

Check to make sure you have all the tools and parts necessary to correctly install this appliance.

#### **Tools required:**

- Adjustable wrench 10" (254 mm) × 2 (for gas connection).
- Flat-blade screwdriver.
- Slip joint pliers.
- Pipe wrench 8" (203 mm) (for gas connection).
- Phillips screwdriver.
- Drill with 1/8" (3 mm) drill bit (for bottom venting only).
- Caulking gun and compound (for installing new exhaust vent).
- Glasses.
- Gloves.
- Knife.
- Hacksaw.
- Spirit level.

## 8 Installation instructions

### Materials:

- 4" (102 mm) diameter rigid metal duct (recommended).
- 4" (102 mm) diameter UL-listed flexible metal duct (if needed).
- 4" (102 mm) diameter metal elbow(s).
- Flexible metal gas line connector (for gas connections only).
- Duct or spring clamps (2).
- Pipe joint compound (pipe dope or tape) for gas pipe connections, resistant to LP Propane, butane and natural gas (for gas connections only).
- Exhaust/vent hood.
- Duct tape.
- Soap solution for gas leak detection (for gas connections only).
- ¾" (19 mm) strain relief (electric connections only).
- Dryer power cord kit (power cord is not supplied with United States models).  
Requirement: UL-rated 120/240 V, 30 amp with 3 or 4 prongs. Identify the plug type needed from the existing house receptacle before purchasing. Length of cord must be at least 5 feet (1.5 m) long.

### To the installer

Read these instructions completely and carefully.

- These instructions must be left with the home owner for future reference.
- Correct installation is the responsibility of the installer.
- Installation of this appliance must be performed by a qualified installer.
- The dryer **must** be exhausted to the outdoors.
- Remove the door from an old dryer before it is removed and discarded.
- The wiring diagram and service information can be found in the control console.
- The limited warranty does not cover product failure as a result of improper installation.
- The dryer must be installed in a location where the temperature is above 50°F (10°C) to ensure suitable operation of the dryer control system.
- UL-listed duct material must be used. Discard existing plastic or metal foil duct and replace with UL-listed duct material.
- Observe all governing codes and ordinances.
- Follow the installation instructions carefully.

### ***Important!***

- *Save these instructions for local electrical inspector's use.*
- *Observe all governing codes and ordinances.*
- *Install the clothes dryer according to the manufacturer's instructions and local codes.*

## Unpacking

To ensure the best performance from the dryer, please follow the instructions below.

### **⚠ WARNING!**



#### **Excess Weight Hazard**

Use two or more people to move and install the dryer.  
Failure to do so can result in back or other injury.

## ***Important!***

**Only remove the packaging at the customer's premises.**

This will ensure the appliance arrives in pristine condition and reduces the risk of damage during transportation to the customer's home.

### **1. Remove packaging**

Remove all of the outer packaging. Dispose of unwanted packaging thoughtfully.

### **2. Discard packing material from around dryer feet**

Tilt the dryer sideways and remove the foam shipping pads by pulling at the sides and breaking them away from the dryer feet. Be sure to remove all the foam pieces before continuing with installation.

### **3. Drying rack (selected models only)**

Open the door. Remove the tape holding the drying rack in place. Remove the rack and remove protective tape from 'legs' of rack.

### **4. Accessories**

Remove the accessories from inside the dryer.

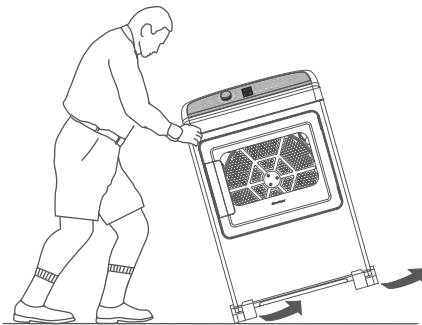

*Fig.2 Unpacking your dryer correctly*

Location requirements

<b>⚠ WARNING!</b>	
	<p><b>Explosion Hazard</b> Keep flammable materials and vapors, such as gasoline, away from the dryer. Place dryer at least 18" (460 mm) above the floor for a garage installation. Failure to do so can result in death, explosion, fire, or burns.</p>

The dryer must be installed or stored in an area which is not exposed to water or weather.

It is extremely important that the dryer is installed in a well ventilated location. This dryer must exhaust air outdoors. Do not install the dryer in any room or closet which does not permit the free flow of replacement air. The free area of any opening for the introduction of outside air shall not be less than twice the area of the dryer exhaust outlet.

The area in which the dryer is located must be kept clear and free from combustible materials, gasoline and other flammable vapors and liquids. A dryer produces combustible lint so the area around the dryer must be cleaned regularly to keep it free of lint.

**Make sure dryer is in a suitable location for installation.**

Consider installing the dryer before the washing machine in a side by side installation, this will allow better access to electrical and exhaust connections.

## Minimum clearance required other than alcove or closet installation

Allow sufficient room behind the dryer for the exhaust. The air intake is at the rear of the dryer.

Ensure that there is a sufficient air passage on each side of the dryer for intake air.

The minimum clearance to combustible surfaces and for air openings are: 1" (25 mm) clearance both sides, 2" (51 mm) clearance at the front, and 1" (25 mm) clearance at the rear, or 5" (127 mm) clearance if the dryer exhaust duct is at the rear. Consideration **must** also be given to provide adequate clearance for proper operation and service.

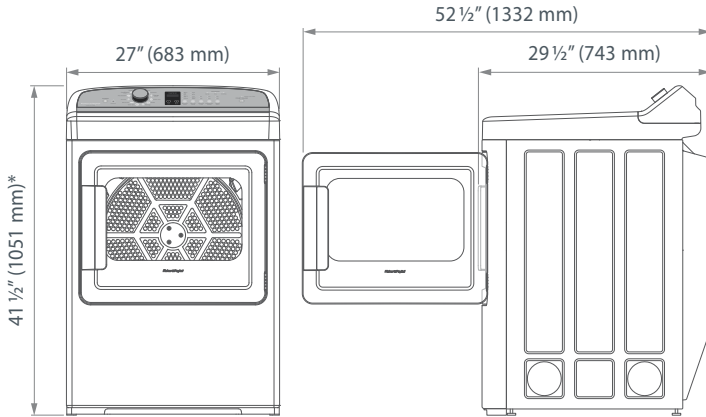

\* Excludes adjustable foot height

Fig.3 AeroCare dimensions

## 12 Installation instructions

### Requirements for alcove or closet installation

Your dryer is approved for installation in an alcove or closet (as specified on the dryer back).

### **⚠ WARNING!**

When installing a dryer in a closet alcove it **MUST** be exhausted to the outdoors. No other fuel burning appliance can be installed in the same closet or alcove.

The total ventilation area must be a minimum of 60 sq. in. (387 cm<sup>2</sup>) of open area equally distributed. If the closet contains both a washer and a dryer, doors must contain a minimum of 120 sq. in. (774 cm<sup>2</sup>) of open area equally distributed. The openings must never be obstructed (a louvered door with the minimum air opening is acceptable). Minimum installation clearances are required but more clearance is recommended.

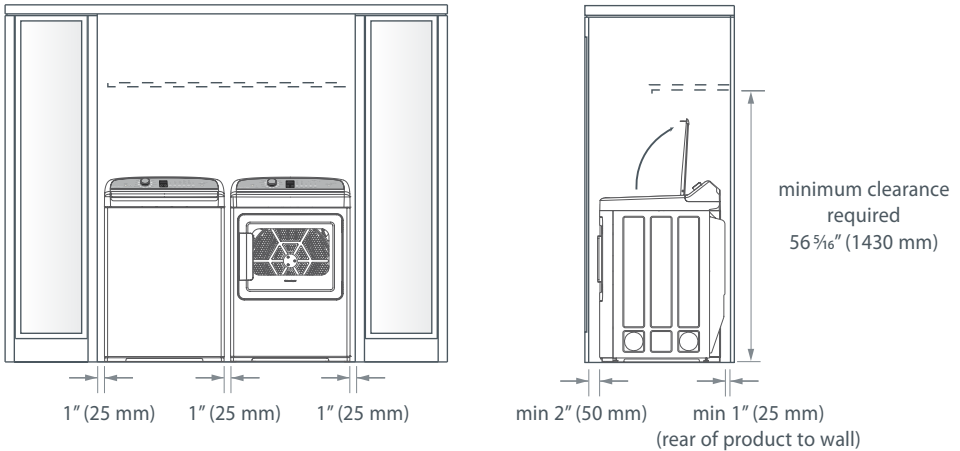
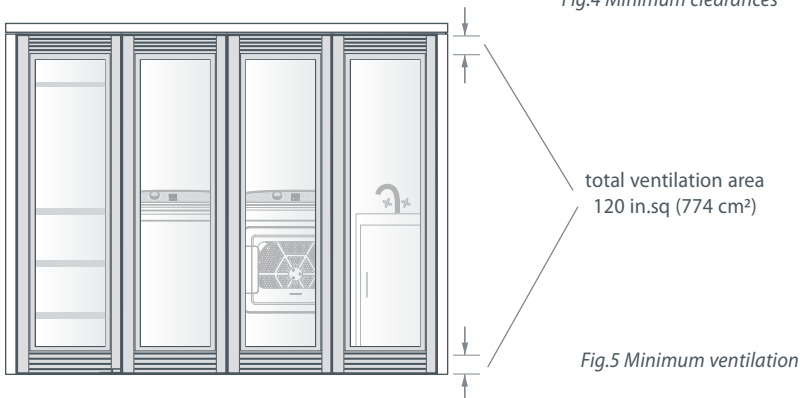

Fig.4 Minimum clearances



## Requirements for alcove or closet installation continued

- The closet should be vented to the outdoors to prevent gas pocketing in case of a gas leak in the supply line.
- No other fuel-burning appliance shall be installed in the same closet with the dryer (gas models only).

Note: when the exhaust duct is located at the rear of the dryer, minimum clearance required from the wall is 5" (127 mm).

### Bathroom or bedroom installation

The dryer **MUST** be vented to the outdoors. See "Exhausting the dryer" (page 26).

## Mobile or manufactured home installation

Installation is required to comply with the Manufactured Home Construction & Safety Standard, title 24 CFR, part 3280. If or when such standard is not applicable, installation must comply with the American National Standard for Mobile Home, ANSI/NFPA No. 501.

- The dryer **MUST** be vented to the outdoors with the termination securely fastened to the mobile home structure.
- Exhaust ducts **MUST** be securely fastened to a non-combustible portion of the mobile home structure.
- The exhaust **MUST NOT** be terminated beneath a mobile or manufactured home.
- The exhaust duct material **MUST BE METAL**.
- The exhaust duct **MUST NOT** be connected to any other duct, vent, or chimney, or be vented into a wall, ceiling or concealed space of a building.
- Do not use sheet metal screws or other fastening devices which extend into the interior of the exhaust vent.

In addition to the above, for gas dryer models:

- Kit 14-D346-33 **MUST** be used to attach the dryer securely to the structure.
- Provide an opening with a free area of at least 25 sq. in. (161 cm<sup>2</sup>) for introduction of outside air into the dryer room.

## Residential garage installation

Dryers installed in residential garages must be elevated 18" (460 mm) above the floor.

The installation must conform with local codes or, in the absence of local codes, with the National Electrical Code, NFPA NO. 70 (for electric dryers) or National Fuel Gas Code, ANSI Z223.1/NFPA54 (for gas dryers) in the United States; and the Canadian Electrical Code CSA C22.1 (for electric dryers) or Natural Gas and Propane Installation Code, CSA B149.1 (for gas dryers), in Canada.

## 14 Installation instructions

### Connecting a gas dryer (skip for electric dryer)

Refer to page 7 for tools required.

Note: installation and service of this dryer must be performed by a qualified installer, service agency or the gas supplier.

#### Gas supply and installation requirements

##### In the Commonwealth of Massachusetts:

- Installation of the dryer must be completed by a plumber or gas fitter licensed by the state.
- When using ball-type gas shut-off valves, the t-handle type shall be used.
- If using a flexible gas connector, this must not exceed a length of 3 feet in total.

## **WARNING!**



### **Explosion Hazard**

Installations must be performed by a qualified or licensed contractor, plumber, or gasfitter qualified or licensed by the state, province, or region where this appliance is being installed.

Use a new AGA or CSA approved gas supply line.

Install a shut-off valve in an accessible place.

Only use a gas shut-off valve approved for use within the state, province, or region where this appliance is being installed.

Securely tighten all gas connections.

If connecting to LP Gas, have a qualified person make sure gas pressure does not exceed 13" (330 mm) water column.

Failure to follow these instructions can result in death, explosion, or fire.



**⚠ WARNING!****To Reduce the Risk of Fire, Electrical Shock and Personal Injury:**

Before connecting the dryer turn off circuit breaker(s) or remove the dryer's circuit fuses at its electrical box. Ensure the power cord is unplugged from the wall socket.

Ensure the gas shut off valve in the supply line is OFF.

Use only new ducting materials. Remove and discard old flexible gas connector and duct material.

## Gas type

This gas dryer is equipped with a valve and burner assembly for use only with natural gas. Your local service organization can convert this dryer for use with propane (LP) gas, using conversion kit WC254C1258A001.

## ***Important!***

*All conversions must be completed by correctly trained and qualified personnel, in accordance with all local codes and ordinances.*

### **Pressure testing**

- The dryer must be disconnected from the gas supply piping system during any pressure testing of the system at a pressure greater than 0.5 psi (3.5 kPa).
- The dryer must be isolated from the gas supply piping system by closing the equipment shut-off valve during any pressure testing of the gas supply piping of test pressure equal to or less than 0.5 psi (3.5 kPa).

### **Gas supply**

- A 1/8" National Pipe Taper (NPT) plugged tapping must be installed immediately upstream of the gas supply connection to the dryer. This must be accessible for test gauge connection. Please contact your local gas utility if you have questions regarding the installation of the plugged tapping.
- The gas supply line is to be 1/2" (12.7 mm) rigid pipe. The line must be equipped with an accessible shut-off which is within 6 feet (1.8 m) of the dryer AND in the same room as the appliance.
- Pipe thread compound appropriate for Natural or Propane (LP) gas must be used.
- New flexible metal gas line connector should be used to connect the dryer and gas supply.

## 16 Installation instructions

### Elevation adjustment

- The input ratings of gas operated clothes dryers are based on their operation at sea level, and need not be adjusted for operation at or below 2000 ft. (610 m) elevation. For operation at elevations above 2000 feet (610 m), input ratings should be reduced at a rate of four percent per 1000 feet (305 m) elevation above sea level.
- Installation must conform to all local codes and ordinances. In the absence of local codes and/or ordinances, installation shall conform to the National Fuel Gas Code, ANSI Z223.1/NFPA 54, or the Natural Gas and Propane Installation Code, CSA B149.1.

### Gas supply connection

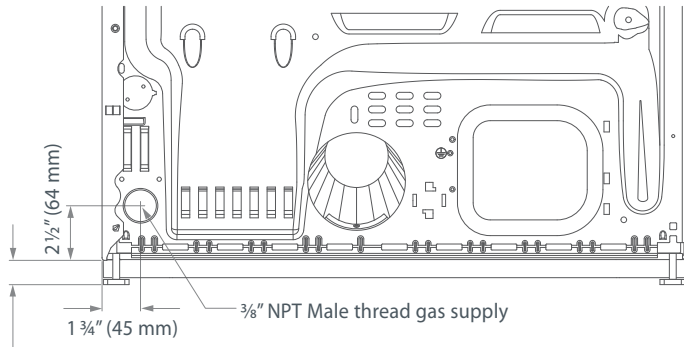

Note: add to vertical dimension the distance between cabinet bottom to floor

Fig.6 Gas connection at rear of dryer

## Connecting the dryer to the gas supply

### Gas connection parts

Ensure you have the following parts before installing the dryer.

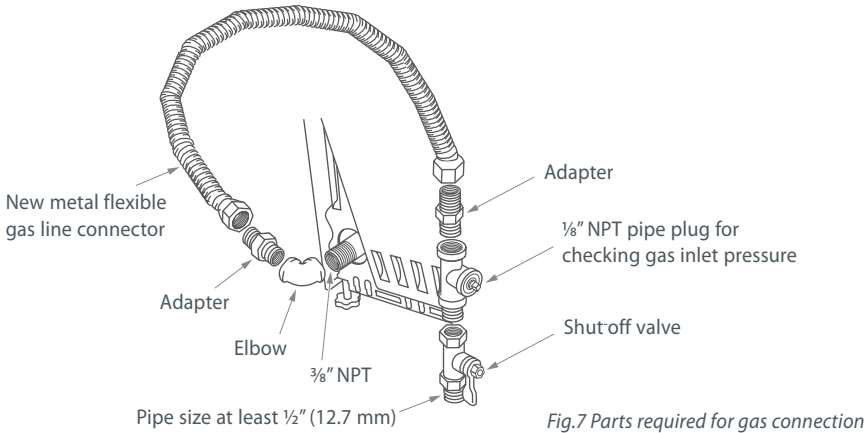

### Connecting to dryer

- Install a female 3/8" NPT elbow at the gas inlet end of the dryer.
- Attach a 3/8" flare union adapter to the female NPT elbow.

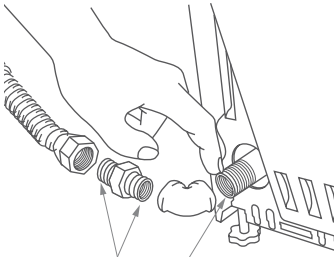

Apply pipe compound to the adapter and dryer gas inlet threads

*Fig.8 Attaching elbow and adapter*

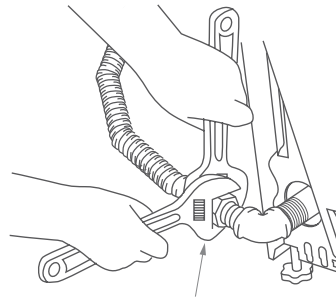

Using two adjustable wrenches tighten the flexible gas line connection

*Fig.9 Tighten connections*

## **Important!**

**Securely hold on to the end of the dryer gas inlet with a pipe wrench to help prevent twisting the inlet.**

### Connecting to supply

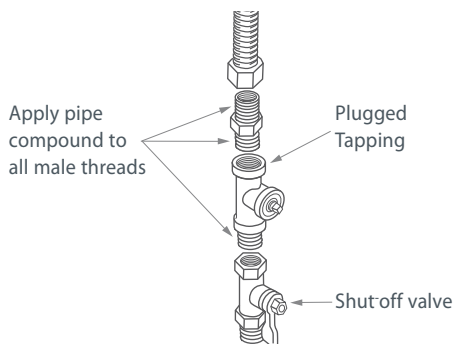

Fig.10 Connecting supply

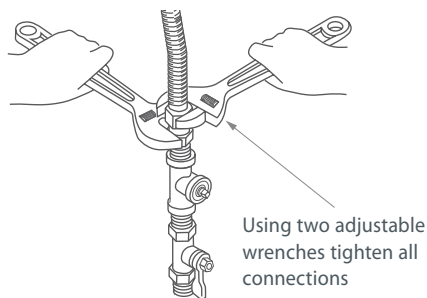

Fig.11 Tightening supply connections

### **Important!**

*Do not over tighten the connections.*

### Test for gas leaks

## ⚠ WARNING!

NEVER use an open flame to test for gas leaks.

- Turn on the gas (open the gas shut off valve).
- All connections should be checked for leaks with a soapy, or equivalent solution. Apply a soap (or equivalent) solution to the connection points. If leaks are found, close the shut-off valve, re-tighten the joint, then repeat the test.

Note: Do not use a solution that contains ammonia. This may cause damage to the brass fittings.

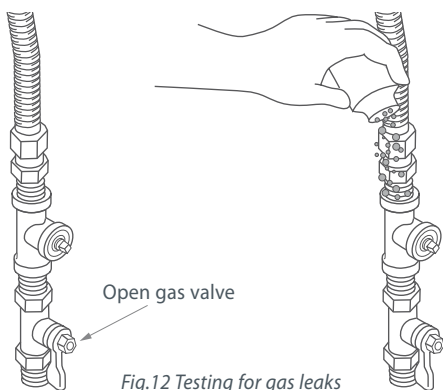

Fig.12 Testing for gas leaks

**⚠ WARNING!****Fire and Poisoning Hazard**

Gas leaks cannot always be detected by the sense of smell.

Use of an approved UL or CSA gas detector is recommended.

If a gas leak is detected follow the “What to do if you smell gas” instructions, stated on the inside front cover of this user guide.

## Electrical connection information for gas dryers

**⚠ WARNING!****Electrical Shock Hazard**

Make sure appliance is wired or plugged into a grounded outlet.

Improper connection of the equipment-grounding conductor can result in a risk of electric shock. Check with a qualified electrician or service person if you are in doubt as to whether the appliance is properly grounded.

Do not modify the plug if it will not fit the outlet.

Have the proper outlet installed by a qualified electrician.

Do not use an adaptor.

Do not use an extension cord.

Failure to follow these instructions can result in death, fire or electrical shock.

The appliance must be electrically grounded in accordance with all local codes and ordinances. In the absence of local codes, the dryer must be electrically grounded in accordance with the National Electrical Code, ANSI/NFPA NO. 70, or the Canadian Electrical Code, CSA C22.1.

**Electrical requirements for gas dryers**

The power supply must be 120V, 60Hz, and connected to a properly grounded branch circuit, which is protected by a 15 or 20 amp circuit breaker, or a time-delay fuse.

If the electrical supply provided does not meet specifications outlined above, the installation of an approved outlet by a licensed electrician is recommended.

**Important!**

*The dryer is supplied with a three-prong (grounding) plug for your protection against electric shock. The plug should be plugged directly into a correctly grounded three prong power socket. DO NOT cut or remove the grounding terminal from this plug.*

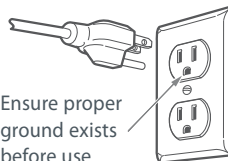
**Ensure proper ground exists before use.**

If local codes permit, an external ground wire (not provided), which meets local codes, may be added by attaching to the green ground screw on the rear of the dryer, and to a grounded metal cold water pipe or other established ground.

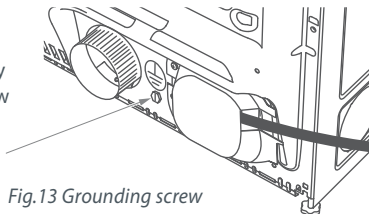

Fig.13 Grounding screw

## Connecting an electric dryer (skip for gas dryers) – in the United States only

Refer to page 7 for tools required.

Electrical requirements (electric models only)

### **WARNING!**

**To reduce the risk of fire, electrical shock & personal injury:**

The appliance must be correctly grounded electrically, in accordance with all local codes and ordinances. In the absence of these, the appliance shall be grounded in accordance with the National Electrical Code ANSI/NFPA No. 70.

Before connecting the dryer, turn off the circuit breaker(s) or remove the dryer's circuit fuses at its electrical box. Ensure the power cord is unplugged from the wall outlet.

DO NOT leave the cover off the terminal block.

Never use an extension cord or adapter plug with the dryer.

Use only new ducting materials. Remove and discard old duct material.

### **WARNING!**



**Electric Shock Hazard**

Use a new UL/CSA-listed 30-ampere power cord.

Use a UL-listed strain relief.

Disconnect power before making electrical connections.

Connect neutral wire (white or center wire) to center terminal.

On all four wire installations remove the grounding link and connect the ground wire to the green ground connecting screw.

Connect remaining two supply wires to remaining two terminals.

Securely tighten all electrical connections.

Failure to do so can result in death, fire, or electrical shock.

Note: the wiring diagram is located in the control console.

The dryer must be plugged into or connected to an individual branch circuit, protected by the correct time delay fuses or circuit breakers. The power supply must be a 3- or 4-wire, single phase, 120/240 V, 60 Hz, 30 amp circuit.

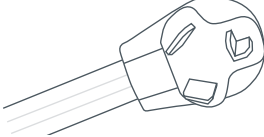
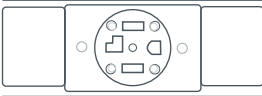
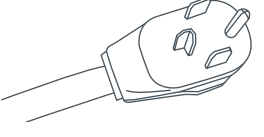
If your outlet looks like this	Choose this power supply cord
 <p data-bbox="311 325 362 347">3-wire</p> <p data-bbox="244 373 441 395">(NEMA type 10-30R)</p>	 <p data-bbox="698 373 931 395">(See 3-wire connection)</p>
 <p data-bbox="311 536 362 558">4-wire</p> <p data-bbox="244 584 441 606">(NEMA type 14-30R)</p>	 <p data-bbox="698 584 931 606">(See 4-wire connection)</p>

- If a power cord is used, this must be plugged into a 30 amp socket only.
- The power cord is NOT supplied with electric model dryers in the United States.

Contact a licensed electrician if the electricity supply does not meet the required specifications.

#### Grounding instructions

This dryer **MUST** be connected to a grounded metal, permanent wiring system. Alternatively, an equipment grounding conductor must be run with the circuit conductors and connected to the equipment grounding terminal on the dryer.

## **⚠ WARNING!**

Improper connection of the equipment-grounding conductor can result in a risk of electric shock. Check with a qualified electrician or service representative if you are in doubt as to whether the appliance is properly grounded.



## Connecting the dryer using 4-wire connection (must be used for mobile home installation)

Note: the National Electrical Code requires that new constructions use a 4-wire connection to an electric dryer (effective as of January 1, 1996). Where local codes do not permit grounding through the neutral, a 4-wire cord must also be used.

### **Important!**

**New constructions must NOT use a 3-wire connection.**

Remove ground strap and discard.  
Keep green ground screw

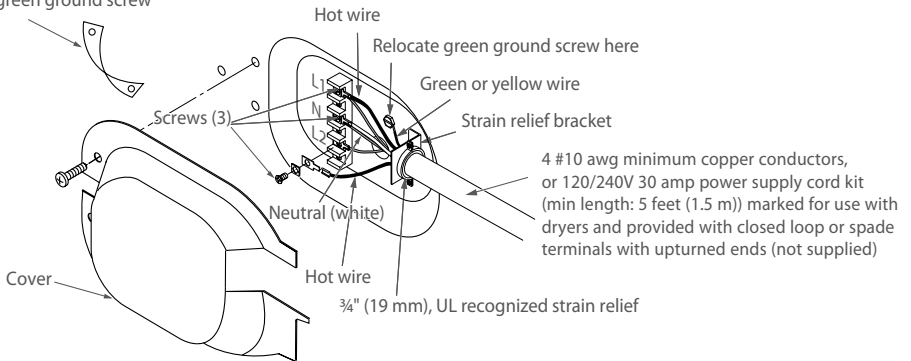

Fig.14 4-wire connections

- 1 Turn off the circuit breaker(s) (30 amp).
- 2 Ensure the dryer cord is unplugged from the wall outlet.
- 3 Locate and remove the power cord cover at the lower rear of the dryer.
- 4 Remove and discard the ground strap. Retain the green ground screw for later relocation (Step 7).
- 5 Install a 3/4" (19 mm) UL-recognized strain relief to the entry hole for the power cord. Move the power cord through the strain relief.
- 6 Connect the power cord according to the following:
  - a Connect the two hot lines to the outer screws of the terminal block (labelled L1 and L2).
  - b Connect the neutral (white) line to the center of the terminal block (labelled N).
- 7 Use the green ground screw to attach the ground wire of the power cord (ie relocate the green ground screw to the hole above strain relief bracket).
- 8 Tighten all three terminal block screws completely.
- 9 Correctly secure the power cord to the strain relief.
- 10 Replace the power cord cover.

## **⚠ WARNING!**

**NEVER** leave the power cord cover off the terminal block.

## Connecting the dryer using 3-wire connection

**Important!**

- **DO NOT use in Canada.**
- **DO NOT use for Mobile home installations, on new constructions, or on recreational vehicles.**
- **NOT for use in areas where local codes prohibit grounding through the neutral conduction.**

If required by local codes, install an external ground (not provided) to grounded metal, a cold water pipe or other established ground as determined by a qualified electrician.

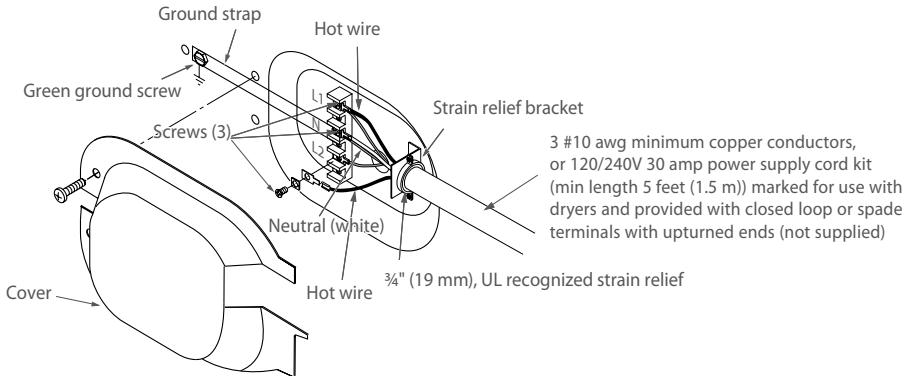

Fig.15 3-wire connections

- 1 Turn off the circuit breaker(s) (30 amp).
- 2 Ensure the dryer cord is unplugged from the wall outlet.
- 3 Locate and remove the power cord cover at the lower rear of the dryer.
- 4 Install a 3/4" (19 mm) UL-recognized strain relief to the entry hole for the power cord. Move the power cord through the strain relief.
- 5 Connect the power cord according to the following:
  - a Connect the two hot lines to the outer screws of the terminal block (labelled L1 and L2).
  - b Connect the neutral (white) line to the center of the terminal block (labelled N).
- 6 Ensure the ground strap is connected to neutral (center) terminal of block, and to the green ground screw on located on the cabinet rear.
- 7 Tighten all three terminal block screws completely.
- 8 Correctly secure the power cord to the strain relief.
- 9 Replace the power cord cover.

## ⚠ WARNING!

**NEVER** leave the power cord cover off the terminal block.

## Connecting an electric dryer (skip for gas dryers) – in Canada only

Electrical requirements (electric models only)

<b>⚠ WARNING!</b>	
	<p><b>Electric Shock Hazard</b></p> <p>Plug appliance into grounded 4 prong outlet.</p> <p>Failure to do so can result in death or electric shock.</p>

Note: the wiring diagram is located in the control console.

### It is your responsibility to:

- Contact a qualified electrical installer.
- Ensure the electrical connection is adequate and conforms with Canadian Electrical Code, C22.1 and all local code requirements.
- Plug the dryer into, or connect the dryer to an individual branch circuit, which is protected by the correct time delay fuses or circuit breakers. The power supply must be a 4-wire, single phase, 120/240 V, 60Hz, 30 amp circuit.

This dryer is supplied with a CSA approved power cord (5 feet (1.52 m) in length, intended for plugging into a 14-30R wall outlet. Ensure the outlet is within reach of the dryer's final location.

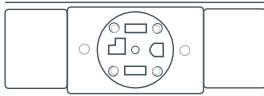

4-wire  
(NEMA type 14-30R)

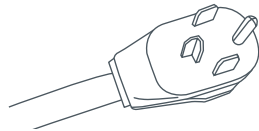

A replacement power cord is available, if required. Use of part number 248C1014G001 (240 V cord set) is recommended. Contact Fisher & Paykel Customer Care (refer to page 86).

## Grounding instructions

This dryer **MUST** be connected to a grounded metal, permanent wiring system.

<b>⚠ WARNING!</b>
<p><b>Improper connection of the equipment-grounding conductor can result in a risk of electric shock. Check with a qualified electrician or service representative if you are in doubt as to whether the appliance is properly grounded. Do not modify the plug provided with the dryer.</b></p>

## Exhausting the dryer

Refer to page 7 for tools required.

<b>⚠ WARNING!</b>	
	<p><b>Fire Hazard</b></p> <p>The dryer must be vented to the outdoors.</p> <p>Use rigid or thick wall flexible metal exhaust duct only.</p> <p>Do not use a plastic exhaust duct.</p> <p>Do not use a metal foil exhaust duct.</p> <p>Failure to follow these instructions can result in death or fire.</p>

- This dryer must be vented to the outdoors. This will prevent the build up of lint and moisture in the room in which it is located and reduce the risk of fire.
- Use only 4" (102 mm) rigid metal ducting material for the home exhaust duct.
- Use only 4" (102 mm) rigid metal or UL-listed flexible metal (semi-rigid or foil-type) duct material to connect the appliance to the home exhaust duct. The ducting must be installed according to the instructions found in the section "Connecting the dryer to the house vent" (page 29).
- The dryer must not under any circumstances be exhausted into a chimney, a wall, a ceiling, gas vent, crawl space, attic, under an enclosed floor, or into any concealed space of a building.
- Never vent the dryer into a common duct with an exhaust system originating from a kitchen. The combination of grease and lint creates a potential fire hazard.
- Ducting must be kept as short in length and as straight as possible. Ducts can accumulate lint and create a potential fire hazard. Do not exceed the maximum exhaust duct lengths stated later in these installation instructions (page 33).
- Never install a screen in or over the dryers exhaust duct. The screen will cause lint to accumulate, creating a potential fire hazard.
- Use duct tape to secure joints in the ducting. Do not use screws as these will extend into the duct system, accumulate lint and create a potential fire hazard.
- Never obstruct incoming or exhausted air.
- Ensure access is provided for inspection and cleaning of the exhaust. This is particularly important at turns and joints. The exhaust system shall be inspected and cleaned annually.
- The dryer is set up for rear exhausting. If space available for installation is limited, the dryer can be vented directly from the sides or bottom of the cabinet. Refer to pages 35 to 38.

## Dimensions

### Exhaust outlet location

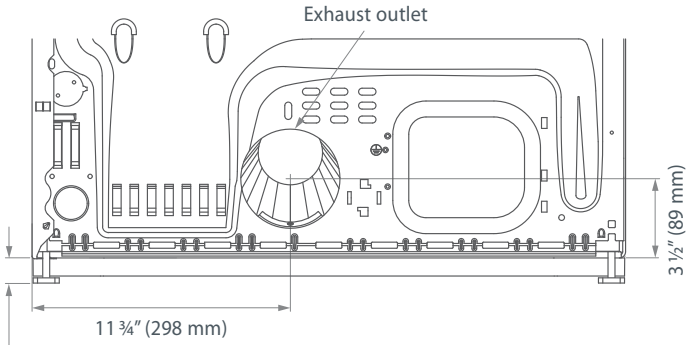

Note: add to vertical dimension the distance between cabinet bottom to floor

*Fig.16 Exhaust outlet dimensions*

### Before you start

- If required, remove and discard of all existing plastic or metal foil duct. Replace this with UL-listed duct material.
- Check for and remove any lint from the vent opening in the wall.
- Ensure the exhaust hood damper moves freely.

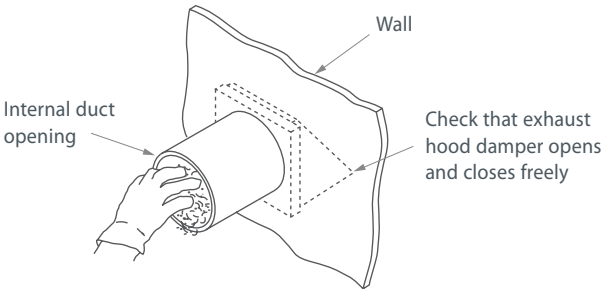

*Fig.17 House vent opening*

### Exhaust system setup

#### Hood or wall cap

- Ensure the exhaust duct ends with a vent hood with a swing out damper to prevent back drafts and entry of wildlife.
- Ensure there is minimal resistance to the exhaust airflow. The structure should also require little or no maintenance to prevent clogging.
- Never place a screen in or over the duct.
- The vent hood should have at least 12" (305 mm) clearance between the bottom of the hood and the ground or other obstruction.
- The hood or wall cap should point downward.

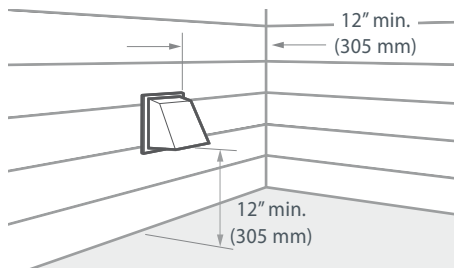

Fig.18 Exhaust hood installation

#### Separation of turns

- Separate all turns by at least 4 feet (1.2 m) of straight ducting (including the distance between the last turn and the wall cap) to ensure the best performance of the dryer.

#### Turns other than 90°

- One turn of 45° or less may be ignored.
- Two 45° turns are to be considered equal to one 90° turn.
- Each turn greater than 45° should be considered as equal to one 90° turn.

### Important!

- *Choose a route that will provide the straightest and most direct path to the outdoors. Plan the installation to use the fewest number of elbows and turns as possible.*
- *When using elbows (rigid duct) or making turns (thick wall flexible metal duct), allow as much room as possible. Bend thick wall flexible metal duct gradually to avoid kinking, and avoid 90° turns using this material.*

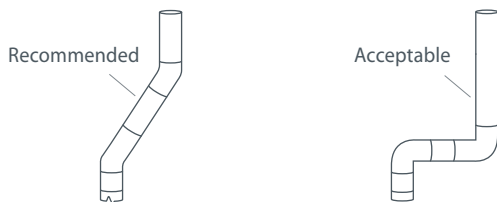

Fig.19 Duct configurations

## Sealing of joints

- All joints must be tightly sealed to avoid leaks.
- The male end of each section of duct must be installed away from the dryer.
- Do not use screws or fasteners that extend into the duct to secure the joint as lint will accumulate around these, creating a potential fire hazard.
- Joints should be made air- and moisture-tight by securing the overlapped joints with duct tape, or aluminum tape.
- Horizontal duct runs should slope down towards the outdoors  $\frac{1}{4}$ " (6 mm) per foot.

## Insulation

- Ducting that is directed through an unheated area or is near air conditioning should be insulated in order to reduce condensation and lint build-up.

## Connecting the dryer to the house vent

### Rigid metal duct

- The use of a rigid metal ducting is recommended for best drying performance.
- The risk of crushing and kinking of the duct is reduced when using this duct material.

### UL-listed flexible metal (semi-rigid) transition duct

- If rigid metal duct is not appropriate, a UL-approved flexible metal (semi-rigid) duct material can be used (kit WC572D559P006).
- Do not install flexible metal duct in walls, ceilings, floors or other enclosed spaces.
- Flexible metal duct should not exceed 8 feet (2.4 m) in total.
- Installing elbows at both the dryer and the wall is highly recommended. An elbow allows the dryer to be positioned close to the wall without kinking and/or crushing the transition duct, and maximizes the performance of the dryer.
- Do not rest the ducting on sharp materials and objects.

### **UL-listed flexible metal (foil-type) transition duct**

- Connecting the dryer to the house vent using flexible metal (foil-type) duct maybe required in some installations. A UL-listed flexible metal (foil-type) duct can ONLY be used where:
  - rigid metal or flexible metal (semi-rigid) ducting cannot be used, AND
  - a 4" (102 mm) diameter can be maintained throughout the entire length of the transition duct.
- Only flexible metal (foil-type) ducts that comply with the requirements of the "Outline for Clothes Dryer Transition Duct Subject UL 2158A", shall be used in the United States and Canada.
- Do not install flexible metal duct in walls, ceilings, floors or other enclosed spaces.
- Flexible metal duct shall not exceed 8 feet (2.4 m) in total.
- Do not rest the ducting on sharp materials and objects.

### **To ensure the best performance of flexible metal (semi-rigid and foil type) transition duct:**

- 1 Slide one end of the duct over the exhaust outlet pipe at the back of the dryer.
- 2 Secure the duct to the pipe with a clamp.
- 3 Move the dryer to its final position.
- 4 Extend the duct to its full length. Allow 2" (51 mm) of duct to overlap the house exhaust outlet pipe. Cut off and remove the unwanted duct. Keep the duct as straight as possible for maximum airflow.
- 5 Secure the duct to the house exhaust outlet pipe with a clamp.



**For transition venting (dryer to wall):**

**DO:**

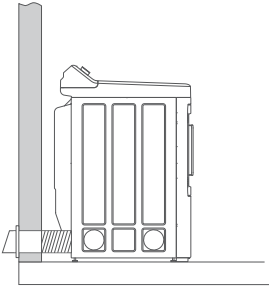

DO cut duct as short as possible and install straight into wall

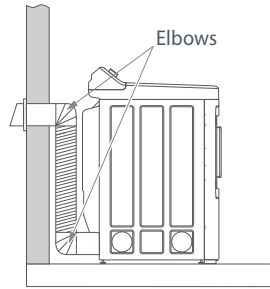

DO use elbows when turns are necessary

*Fig.20 Correct venting installation*

**DO NOT:**

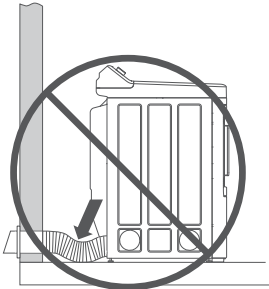

DO NOT bend or collapse ducting  
Use elbows if turns are necessary

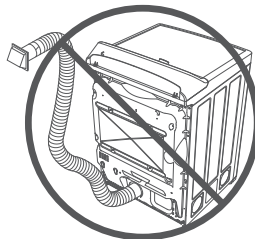

DO NOT use excessive exhaust length  
Cut duct as short as possible

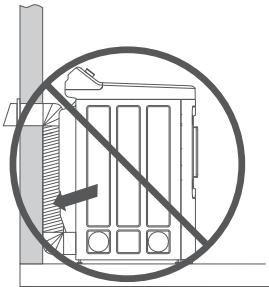

DO NOT crush duct against the wall

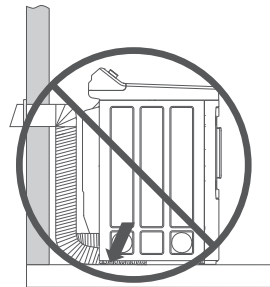

DO NOT set dryer on duct

*Fig.21 Dangerous venting installation set ups*

## Exhaust Length

### Maximum length of exhaust duct

The maximum length of the exhaust duct system depends upon:

- The type of ducts used (rigid or thick-walled flexible metal).
  - The number of elbows or bends used.
  - The type of exhaust hood (wall cap).
- 1 Refer to the exhaust duct length chart (page 33) that matches your hood type to determine the maximum duct lengths you can use. DO NOT use duct lengths longer than specified in the exhaust duct length charts.

### Using exhaust duct systems longer than is specified will:

- Accumulate lint creating a potential fire hazard.
  - Shorten the life of the dryer.
  - Reduce the performance, resulting in longer drying times and an increased energy usage.
- 2 Determine the number of elbows/bends you will need.
- 3 In the column listing the type of metal duct you are using (rigid or flexible metal), find the maximum length of metal duct on the same line as the number of elbows/bends to be used (refer to page 33).

## ***Important!***

- *Use 4" (102 mm) metal duct only.*
- *Do not use duct that is longer than that specified in the table on page 33.*
- *Flexible metal duct shall not exceed 8 feet (2.4 m) in total.*

The correct exhaust installation is YOUR RESPONSIBILITY.

Problems due to incorrect installation are not covered by the limited warranty.

## **WARNING!**

Incorrect installation of the exhaust duct may result in poor dryer performance and increase the risk of fire.

## Preferred 4" (102 mm) Hoods

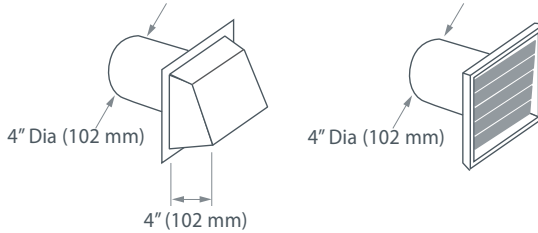

## When you have a 4" (102 mm) Hood

Number of 90° elbows/bends	Maximum length of 4" (102 mm) diameter metal duct.			
	Rigid metal		Flexible metal (fully extended)	
0	90 ft	27.4 m	8 ft	2.4 m
1	60 ft	18.3 m	8 ft	2.4 m
2	45 ft	13.7 m	8 ft	2.4 m
3	35 ft	10.7 m	8 ft	2.4 m
4	25 ft	7.6 m	8 ft	2.4 m

## Acceptable 2½" (64 mm) Hood (for short length installations)

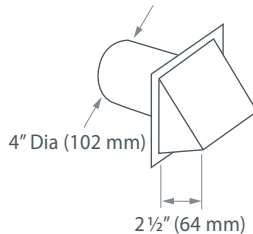

## When you have a 2½" (64 mm) Hood

Number of 90° elbows/bends	Maximum length of 4" (102 mm) diameter metal duct.			
	Rigid		Flexible Metal (fully extended)	
0	60 ft	18.3 m	8 ft	2.4 m
1	45 ft	13.7 m	8 ft	2.4 m
2	35 ft	10.7 m	8 ft	2.4 m
3	25 ft	7.6 m	8 ft	2.4 m
4	15 ft	4.6 m	8 ft	2.4 m

**Standard rear exhaust**

We strongly recommend the use of rigid metal exhaust duct. We recommend you install your dryer first, before installing your washer. This will allow you easier access for connecting the exhaust.

Place the end of the exhaust duct on the outlet at the rear of the dryer. Secure with duct tape or a hose clamp. For a straight installation, connect the dryer exhaust directly to the wall. Use duct tape to secure the joint.

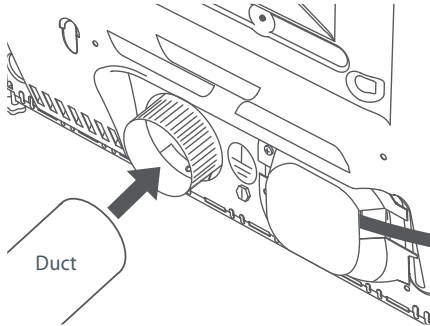

Fig.22 Attaching the metal duct to the dryer outlet

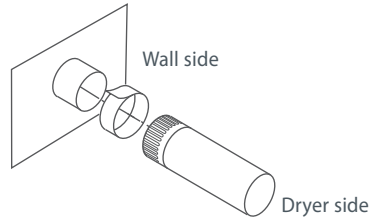

Fig.23 Securing the duct joint with duct tape

Dryer exhaust to right, left or bottom of cabinet

## ⚠ WARNING!

Before performing this exhaust installation, be sure to disconnect the dryer from its electrical supply. Protect your hands and arms from sharp edges when working inside the cabinet. Be sure to wear gloves.

### Important!

- Dryer exhaust to right of cabinet (electric models only).
- Dryer exhaust to left of cabinet (gas and electric models).

Detach and remove the bottom, right or left side knockout (the opening for alternate ducting), as preferred for the direction of ducting. Tape around the knockout and exhaust opening to provide protection from sharp edges during installation. Remove the screw inside the dryer exhaust duct and slide the duct out of the dryer. Keep the screw. Cut the duct as shown in Figure 24. Retain portion A of the duct.

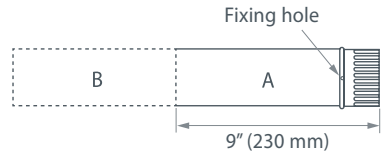
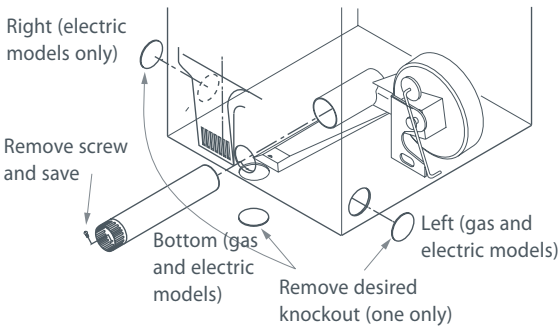

*Fig.24 Removing and shortening the duct*

### Tab location

Through the rear opening, find the tab located in the middle of the dryer base. Using a flat blade screwdriver, lift the tab to approximately 45°.

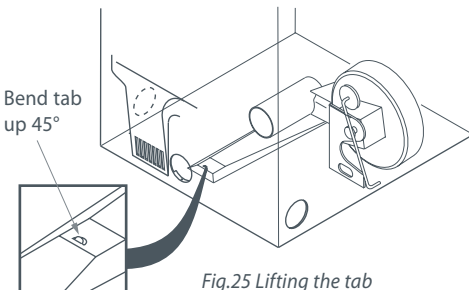

*Fig.25 Lifting the tab*

## 36 Installation instructions

### Adding shortened duct section

Connect portion "A" of the original length of duct to the blower housing, ensuring the shortened duct is aligned with the tab in the base. Use the screw saved previously to secure the duct in place through the tab on the dryer base.

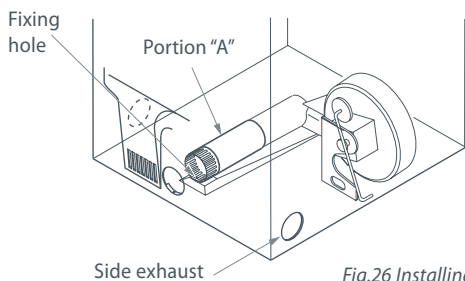

Fig.26 Installing shortened duct section

## Adding ducting for exhaust to the right or left side of the cabinet

- Assemble a 4" (102 mm) elbow with a 4" (102 mm) length of duct. Secure the joint with duct tape.
- Insert the elbow end of the duct assembly carefully through the side opening, and connect this end to the internal duct of the dryer (inside).

### **⚠ WARNING!**

Be sure not to pull or damage the electrical wires inside the dryer when inserting the duct. Internal duct joints must be secured with tape, otherwise they may separate and cause a safety hazard.

Exhaust can be added to the left (gas or electric models) or right side (electric models only)

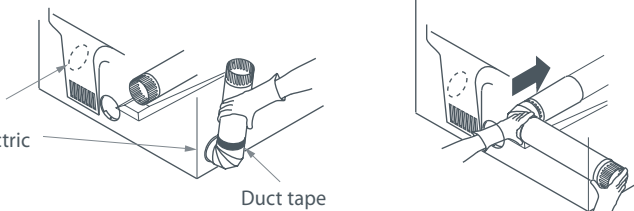

Fig.27 Left and right exhausting

- Use duct tape (as shown in Figure 28) to secure the joint between the dryer internal duct and the elbow, and also the joint between the elbow and the side duct.

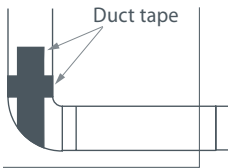

Fig.28 Securing joints correctly with duct tape

- Cover the original duct opening at the back with a plate (kit WE1M454), available from Fisher & Paykel, refer to page 86).

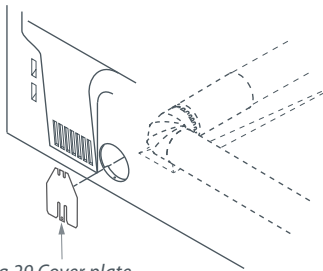

Fig.29 Cover plate

### Adding elbow for exhaust through bottom of cabinet

- Insert the elbow section of the duct through the rear opening and connect it to the dryer internal duct.
- Secure the joint between the internal duct and elbow with duct tape, as shown in Figure 28 (page 37).

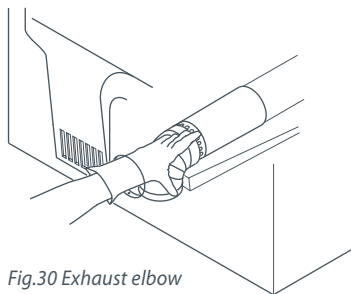

Fig.30 Exhaust elbow

- Complete the exhaust system by connecting the required standard metal elbows and ducts.
- Cover the original duct opening at the back with a plate (kit WE1M454, available from Fisher & Paykel (refer to page 86). Refer to Figure 29 (page 37).
- Move the dryer into its final position.

### **WARNING!**

The rear duct opening must be covered with a plate. The dryer must not be operated without the plate in place.



## Water connection (for selected models with Steam cycles)

### Supply requirements

The hot and cold faucets **MUST** be installed no further than 42" (1070 mm) from the washer's inlet supply. Faucets need to be  $\frac{3}{4}$ " (19 mm) so the inlet hoses can be connected correctly.

Inlet water pressure required: Min. 10 psi (70 kPa) to Max. 120 psi (827 kPa). Consult your Water Department for information about the pressure supplied to your home.

Note: if your domestic water supply is hard, we recommend using a water softener to help reduce the build up of lime scale within the steam generator. Over time, a build up of lime scale may block up the water system, causing reduced performance and the possible need for part repair or replacement.

### Water supply connection

For the Steam cycles to work correctly, the dryer must be connected to the cold water supply. A "Y" connector can be used so that the washer (which also requires a cold water supply) and dryer can be connected to the cold supply at the same faucet.

## **Important!**

*Use the new inlet hoses provided with your dryer. Never reuse old hoses or rubber washers.*

### Inlet hose replacement

We recommend the inlet hoses are changed every 5 years. Hoses should also be checked from time to time and replaced if any wear, cuts, bulges, kinks or leaks are found. **WARNING!**: Failure to do so may result in a flood and damage to property.

### To connect the dryer

#### Parts required:

- Flat rubber washers (4).
- Filter washer.
- "Y" connector.
- Short inlet hose.
- Long inlet hose.

- 1 Ensure the cold faucet is turned off. Disconnect the cold inlet hose from the end of the faucet.
- 2 Insert the filter washer into one female coupling of the short inlet hose and connect it to the cold faucet.
- 3 Insert a flat washer into one male coupling of the "Y" connector and fit the connector to the other female coupling of the short inlet hose.

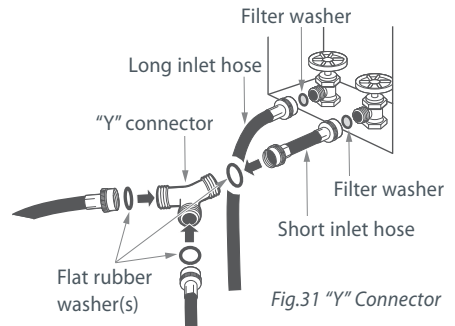

Fig.31 "Y" Connector

- 4 Check that the washer inlet hose (which has been removed from the faucet) has a flat washer or filter washer fitted. If not insert a flat washer and connect the hose to one of the male couplings on the "Y" connector.
- 5 Take the long inlet hose and insert a flat washer into the straight female coupling and connect it to the other male coupling on the "Y" connector.
- 6 Insert a flat rubber washer into the other female connector and couple the hose to the inlet valve on the rear of the dryer.

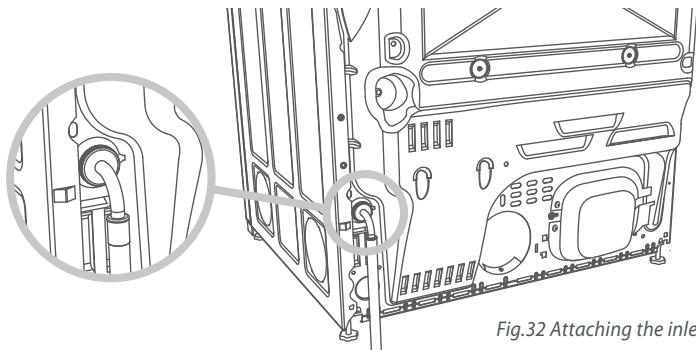

Fig.32 Attaching the inlet hose to the dryer

- 7 Check that all connections are firmly hand tight, then using a pair of pliers tighten each coupling another two-thirds of a turn.

**Important!**

Ensure you **DO NOT OVERTIGHTEN** the connections. Overtightening may result in damage to the couplings.

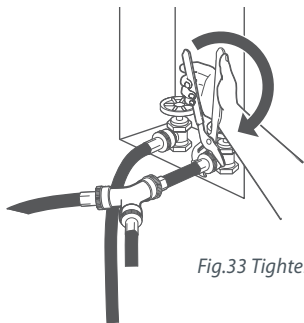

Fig.33 Tightening the connections

- 8 Check immediately for any leaks from the "Y" connector, hose couplings and/or the faucet. Check again for leaks after 24 hours.

## Reversing the door

### Tools required:

- Standard #2 Phillips screwdriver.
- Tape-tipped putty knife.
- Needle-nosed pliers.

- 1 Remove the plug from the power outlet.
- 2 Open the door and remove the blanking plugs opposite the hinges. Retain the blanking plugs for Step 4.
- 3 With the door completely open, remove the bottom screw from each hinge on the dryer face. Insert these screws about half way into the **top** holes, for each hinge, on the opposite side (where you removed the plastic plugs). Apply firm pressure to get the screw started in untapped holes.

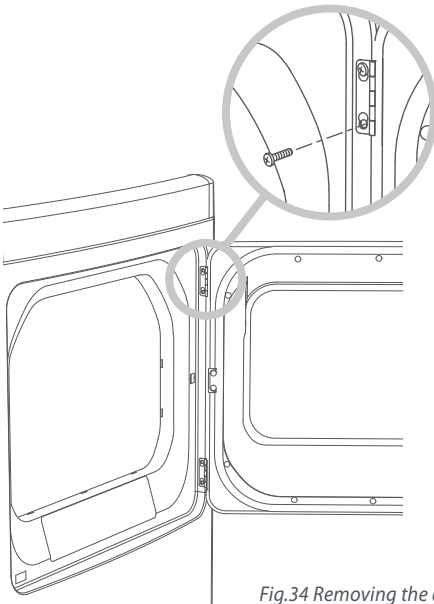

Fig.34 Removing the door

- 4 Loosen the top screw from each hinge on the dryer face to half way. With one hand holding the top of the door and the other hand holding the bottom, remove the door from the dryer by lifting it up and out. Remove the two remaining screws and retain for later use. Fit the blanking plugs removed in Step 2.

## 42 Installation instructions

- 5 To invert the direction of the door panel, lay the door face down on a safe, protected surface and remove the four screws from the hinges.

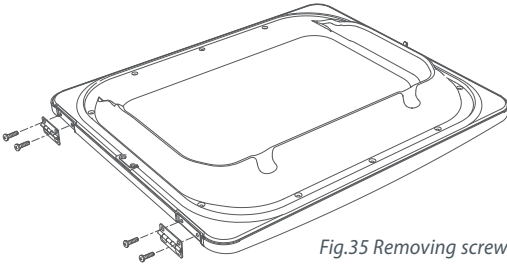

Fig.35 Removing screws from the hinges

- 6 Separate the door panel from the inside of the door by removing the six screws, as shown in Figure 36.

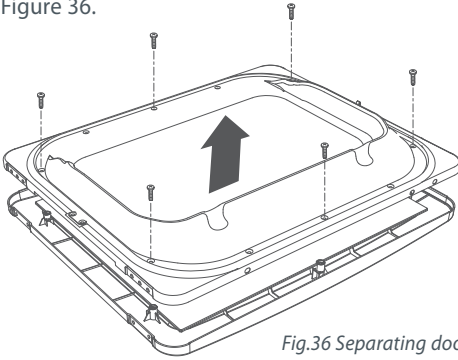

Fig.36 Separating door panel from inside of door

### **Important!**

*Remove only the six screws as shown.*

- 7 Lift and rotate the door panel 180° then reinsert the inside of the door in the panel. Replace the six screws removed in Step 6.

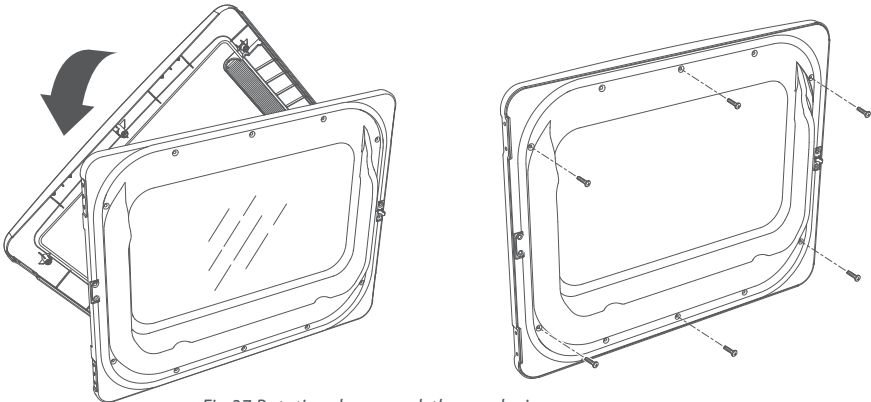

Fig.37 Rotating door panel, then replacing screws

- 8 Reattach the hinges on the opposite side to the door handle, using the same four screws on the hinge retained from removing the hinges in Step 5.

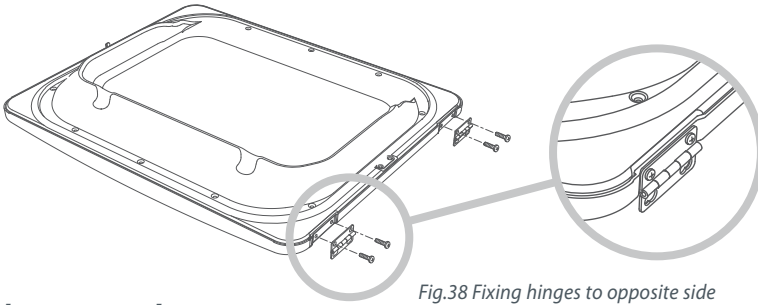

Fig.38 Fixing hinges to opposite side

## **Important!**

Check the position of the hinge as shown in Figure 38.

- 9 To change the direction of the door strikes, unscrew both the cover plate and the strike plate (the strike plate being the plate with the metal part protruding). Reinstall one plate in place of the other.

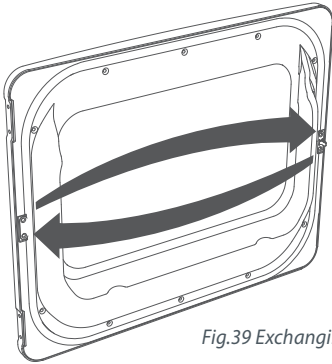

Fig.39 Exchanging cover plate and strike plate location

- 10 Install the door on the opposite side of the opening by moving the door in and down until the top hinge and bottom hinge are resting on the two screws inserted in Step 3. With the two screws retained in Step 4, secure each hinge at the bottom.

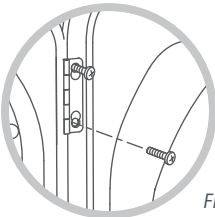

Fig.40 Installing the door in the reverse position

- 11 Tighten the two top screws of each hinge.

## Leveling the dryer

Position the dryer near the final location. Adjust the four leveling legs (wind up or down) at the corners as needed, to ensure the dryer matches the height of the washer and is level from side to side and front to back. The dryer must rest firmly on all four legs, and not rock in any direction.

- 1 Move the dryer to its final location.
- 2 To ensure the dryer is correctly level from side-to-side, place a spirit level on the top center of the machine. If level, the air bubble will sit between the two lines.
- 3 To check whether the dryer is correctly level from front-to-back, open the door to the 90° position, place the spirit level on the top edge of the door and check the bubble sits between the two lines.
- 4 If the dryer is not level in any direction, adjust the height of the appropriate leg(s) until the dryer is correctly level.

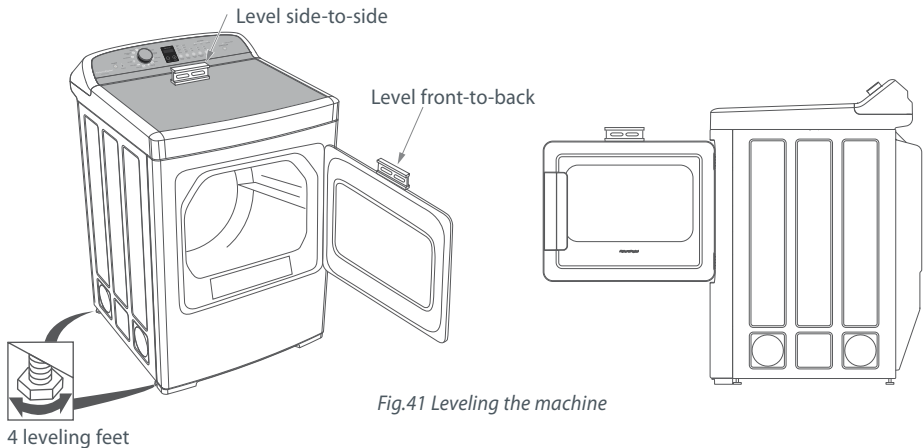

## Installation checklist

### 1. Packaging

Have all of the packaging materials been removed, and disposed of responsibly? Remove the accessories from the drum.

### 2. Parts

Check that all parts have been installed.

### 3. Tools

Check all tools are present.

### 4. Grounding

#### ***Important!***

***Make sure the dryer is correctly grounded before operating.***

This appliance must be grounded. In the event of malfunction or breakdown, grounding will reduce the risk of electric shock by providing a path of least resistance for electric current. This appliance is equipped with a cord having an equipment-grounding conductor and a grounding plug. The plug must be plugged into an appropriate outlet that is properly installed and grounded in accordance with all local codes and ordinances.

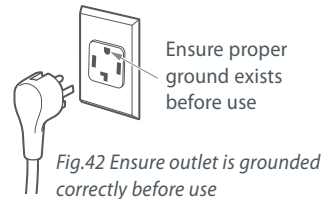

### 5. Installation

#### **Please ensure:**

- No plastic or non-UL listed flexible metal foil material has been used for the exhaust ducting.
- Exhaust material used is either rigid ducting or thick wall flexible metal ducting.
- All joints in the ducting are secured with duct tape, as described in the instructions. Screws or other fastening devices which extend into the inside of the duct should not be used.
- Ducting system is clean and is correctly and securely connected to the dryer.
- The ducting system is not being crushed or kinked when the dryer is in its final position.
- The faucets are turned on. Check for leaks around the connections (at the Y connector, hoses and faucets).
- The dryer is correctly level and does not rock in any direction.
- The inside of the drum is wiped out with a damp cloth to remove any residue remaining from manufacture or installation, before use.

## Installation instructions

### **Additionally for electric dryer models only, check:**

- Dryer is plugged or directly wired into an approved fitting, and is properly grounded.
- Dryer starts, heats, cools and shuts off.
- Customer has been shown how to use the dryer.

### **Additionally for gas dryer models only, check:**

- Dryer is plugged into an approved fitting, and is properly grounded.
- All fittings in the gas line have been tested for leaks.
- Exhaust temperature increases, to confirm ignition has occurred.
  - If ignition does not occur initially, it may be due to air in the gas line or low voltage power supply.
  - The gas regulator valve may fail to open if the power supply falls below 105 Volts.
  - If the gas fails to flow or does not ignite, the dryer will automatically switch off.
- Customer has been shown how to use the dryer.

## 6. Turning the dryer on

To turn the dryer on, simply touch the POWER button.

Note: if the dryer has been exposed to temperatures below freezing for an extended period of time, allow it to warm up before touching POWER. Otherwise, the display will not come on.

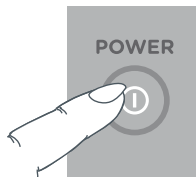

### **If the dryer will not start, check that:**

- The START/PAUSE button has been pressed firmly.
- The dryer is plugged in and the power is turned on. Could the household supply be at fault?
- The household fuse is intact and that the circuit breaker has not been tripped.
- The dryer door is completely closed.

The dryer may emit an odor when it is first used. This is due to the new heating element, and is normal. The odor will diminish with the use of the dryer.

## ***Important!***

*Please read the user guide in its entirety and familiarize yourself with the correct use and care of the dryer.*



## Servicing

### ***Important!***

*Label all wires prior to disconnection when servicing controls. Wiring errors can cause improper and dangerous operation after servicing/installation.*

For service and other information, refer to the "How to get service" section in the back of this book (refer to page 86).

### **Drum light replacement**

Before replacing the light bulb, be sure to unplug the dryer power cord or disconnect the dryer at the household distribution panel by removing the fuse or switching off the circuit breaker. Reach inside, above the dryer opening inside the drum. Remove the bulb and replace with the same size bulb.

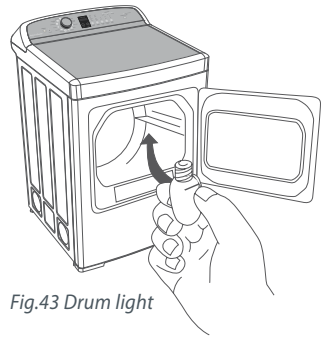

Fig.43 Drum light

## The first time you turn your dryer on

Remove the protective tape from the control panel.

### ⚠ WARNING!



#### **Electric Shock Hazard**

To reduce the risk of fire, electric shock, or injury to persons, read and follow the **IMPORTANT SAFETY INSTRUCTIONS** outlined in this User Guide before operating this appliance, pages 3 – 6.

Failure to do so can result in death, electric shock, fire or injury to persons.

## Features

### **Perfect with your Fisher & Paykel washer**

The dryer combined with the washer's superior spin performance and quick cycle times will cut laundry turn around time, reducing the time you spend doing laundry.

### **Superior clothes care**

Superior clothes care is accomplished by an efficient high airflow fan and careful heat control. Your AeroCare dryer provides the right heat for temperature-sensitive delicate garments while still efficiently drying more robust regular and denim loads.

### **Autosensing**

AeroCare's internal computer measures the moisture content of the load using metal sensing bars and together with a temperature sensor determines when the clothes have reached the selected dryness level.

### **Steam cycles (selected models only)**

Two cycles, AEROSTEAM and AEROSTEAM PLUS use pulses of steam to de-wrinkle items and/or freshen your garments from unpleasant odors or after prolonged storage.

### **Stainless steel drum (selected models only)**

AeroCare's stainless steel drum is not only more hygienic, it's also more resilient and is easier to keep looking good.

## **Wrinkle Free**

Use WRINKLE FREE to minimize wrinkling and creasing in your garments. After the clothes are dried, they will be tumbled periodically in cool air. WRINKLE FREE will continue for 24 hours or until the dryer is stopped by pressing POWER, or opening the door.

WRINKLE FREE can be selected if you are using one of the automatic cycles (excluding the ENERGY SAVER cycle), and on the TIME DRY cycle.

## **Drum light**

A convenient light located inside the dryer helps make unloading easier. The light switches on automatically when the door is opened.

For drum light replacement, please refer to page 47.

## **Drying rack**

The drying rack can be used for drying articles such as soft toys, pillows, washable sweaters and shoes, ie items that are too delicate or maybe damaged by tumbling. Place (hook) the rack over the lint filter so that it extends back into the drum.

Note: the drying rack should be used with the RACK DRY or TIME DRY cycles only. Also, the drying rack should not be used when there are other items in the dryer as this may cause damage to the garments.

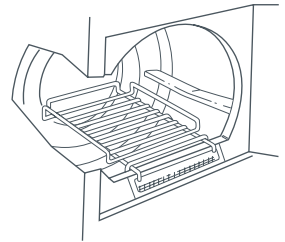

Fig.44 Drying rack

## AeroCare DE7027P, DG7027P

- Ensure the lint filter has been cleaned before each drying cycle. Check the lint filter has been replaced correctly in its housing before using your dryer.
- Sort and load items into the dryer drum. Ensure that no items are caught in the way of the door, then close the door. Check the door is fully closed before starting the dryer.

### **Important!**

*Ensure there is plenty of room for the garments to tumble freely while drying – do not overload your dryer. Load in terms of the space clothes take up when dry rather than when they are wet.*

- 1 Press POWER to activate your dryer.
- 2 Your dryer will default to the REGULAR cycle. Select your desired drying cycle by turning the SmartTouch™ Control Dial.
- 3 Select your preferred drying options (if you wish to select different options from the default options programmed for the cycle) using the SmartTouch™ buttons on the right hand side of the panel.
- 4 Touch the START/PAUSE button to start the drying cycle.

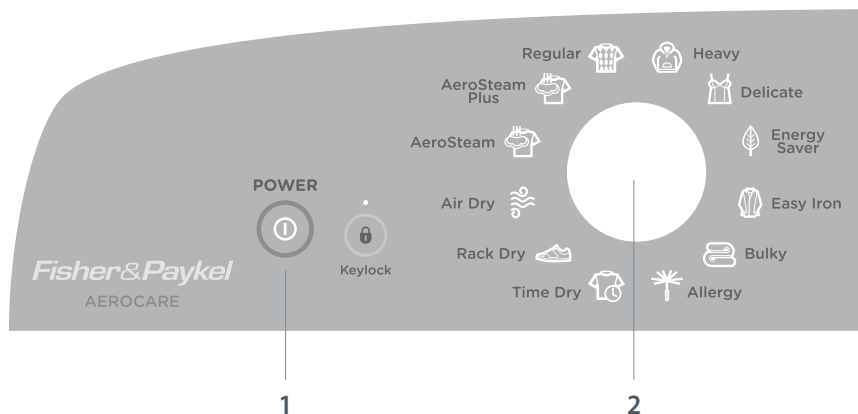

Fig.45 AeroCare control panel (DE7027P, DG7027P)

Note: the control panel may differ depending on what model of dryer you have.

- If you make an invalid selection the dryer will beep to alert you.
- When the cycle finishes, your dryer will beep to alert you and then turn off automatically. If the WRINKLE FREE option has been selected the machine will rotate the drum periodically after the end of the cycle, blowing cool air into the drum to help minimize wrinkling of the clothes.
- If you wish to stop your dryer at any point during a cycle simply touch START/PAUSE to pause the cycle, then open the door. To restart the dryer, close the door and touch START/PAUSE to resume the cycle.
- If you wish to cancel a cycle or select a different option once a drying cycle has started, touch the START/PAUSE button then select the new cycle or option. Touch START/PAUSE to restart the dryer with the new settings.

## Important!

*If you wish to stop the dryer before the cycle has finished you MUST remove the clothes IMMEDIATELY and spread them out to cool. DO NOT leave the clothes in the dryer or bunched up in a clothes basket, these must be spread out in order for the heat to dissipate. There is a risk of spontaneous combustion. Take extreme care when removing items as the drum and the load items may be extremely hot.*

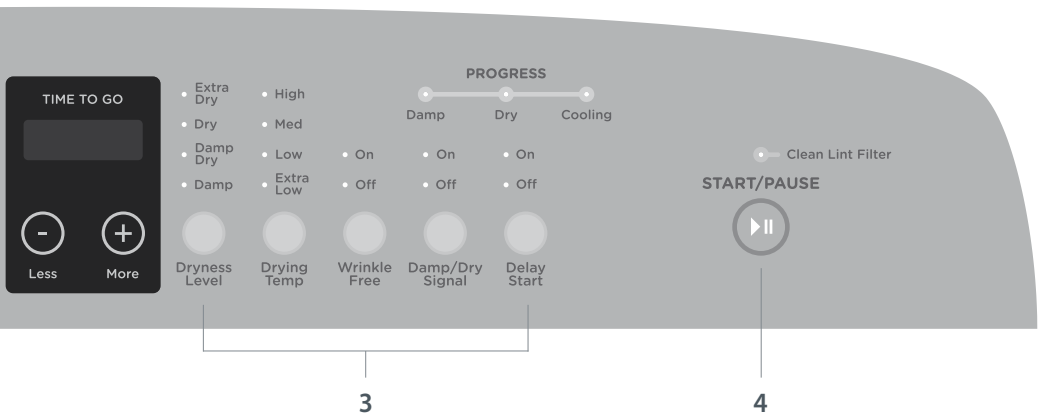

## Important!

*Failure to follow the advice in this guide may result in damage to your garments and your expectations of drying performance may not be met.*

Note: selected drying cycles and options may not be available depending on your model of dryer.

## AeroCare DE7027G, DG7027G

- Ensure the lint filter has been cleaned before each drying cycle. Check the lint filter has been replaced correctly in its housing before using your dryer.
- Sort and load items into the dryer drum. Ensure that no items are caught in the way of the door, then close the door. Check the door is fully closed before starting the dryer.

### **Important!**

*Ensure there is plenty of room for the garments to tumble freely while drying – do not overload your dryer. Load in terms of the space clothes take up when dry rather than when they are wet.*

- 1 Press POWER to activate your dryer.
- 2 Your dryer will default to the REGULAR cycle. Select your desired drying cycle.
- 3 Select your preferred drying options (if you wish to select different options from the default options programmed for the cycle) using the *SmartTouch™* buttons on the right hand side of the panel.
- 4 Touch the START/PAUSE button to start the drying cycle.

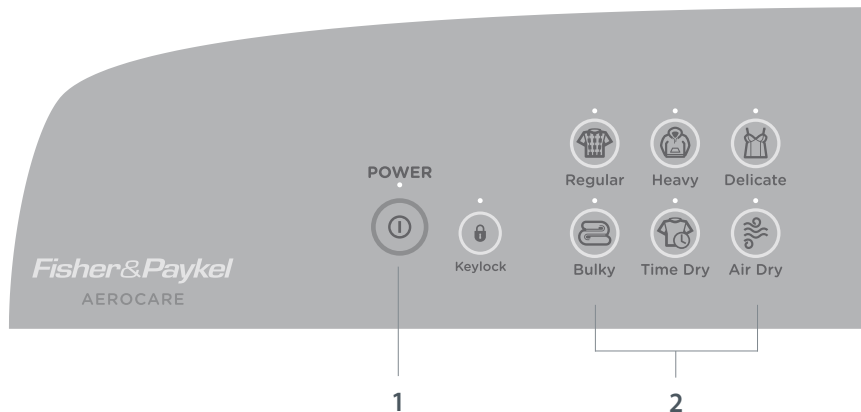

Fig.46 AeroCare control panel (DE7027G, DG7027G)

Note: the control panel may differ depending on what model of dryer you have.

- If you make an invalid selection the dryer will beep to alert you.
- When the cycle finishes, your dryer will beep to alert you and then turn off automatically. If the WRINKLE FREE option has been selected the machine will rotate the drum periodically after the end of the cycle, blowing cool air into the drum to help minimize wrinkling of the clothes.
- If you wish to stop your dryer at any point during a cycle simply touch START/PAUSE to pause the cycle, then open the door. To restart the dryer, close the door and touch START/PAUSE to resume the cycle.
- If you wish to cancel a cycle or select a different option once a drying cycle has started, touch the START/PAUSE button then select the new cycle or option. Touch START/PAUSE to restart the dryer with the new settings.

## Important!

*If you wish to stop the dryer before the cycle has finished you **MUST** remove the clothes **IMMEDIATELY** and spread them out to cool. **DO NOT** leave the clothes in the dryer or bunched up in a clothes basket, these must be spread out in order for the heat to dissipate. There is a risk of spontaneous combustion. Take extreme care when removing items as the drum and the load items may be extremely hot.*

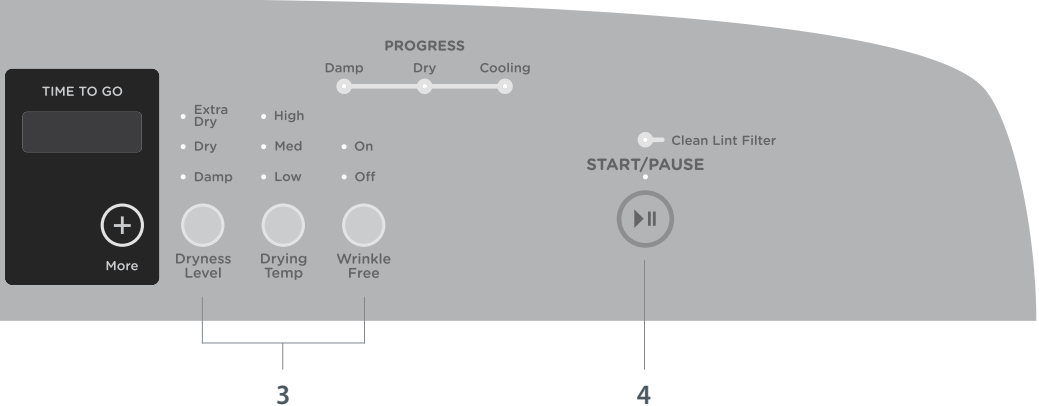

## Important!

*Failure to follow the advice in this guide may result in damage to your garments and your expectations of drying performance may not be met.*

Note: selected drying cycles and options may not be available depending on your model of dryer.

## **SmartTouch™ Control Dial (selected models only)**

The *SmartTouch*™ Control Dial provides easy and efficient drying cycle selection. As you rotate the dial, the icon of the drying cycle selected will be illuminated, along with the default settings for that cycle on the right side of the control panel.

## **SmartTouch™ buttons**

The smooth, easy clean buttons enable simple selection of options with lights clearly showing the selections you are making.

## **Digital display screen**

The digital display screen provides feedback on how long the drying cycle has to go. If you have programmed a DELAY START, the time remaining until the cycle will start will be displayed here, along with any messages to help you with the overall running of your dryer (eg user warnings).

## **Time to go**

Your AeroCare dryer displays approximately how many minutes the cycle has remaining, so that you can tell at a glance when your drying will be finished. Please be aware that a number of factors influence the overall cycle time, eg the fabric type, load size, the wetness of the load, environmental conditions, etc. If the dryer display screen shows a dashed line tracing around the outside of the screen, this indicates the dryer is sensing the moisture in the load. The updated time remaining will soon appear on the screen.

## **Progress lights**

The progress lights indicate what part of the cycle the dryer is currently up to (DAMP, DRY, or COOLING). The light for the current part of the cycle flashes, to let you know at a glance how dry your load is.



## Keylock

Keylock can be used to deactivate the buttons on your AeroCare dryer when it is in use. This will avoid accidental button touches from items left on top of the dryer (eg washing baskets, clothing) as well as touches from any little fingers.

### To turn Keylock ON or OFF:

- Touch and hold the KEYLOCK button for two seconds.  
Note: when activated, the light above the KEYLOCK button is illuminated.

### If Keylock is activated:

- To turn your dryer on, **touch and hold the POWER button for two seconds**. This will activate the control panel. Keylock will remain activated but let you select your drying cycle options and start the cycle.
- To PAUSE your dryer at any time during the cycle, **touch and hold the START/PAUSE button for two seconds**.
- To STOP your dryer and power off, simply touch the POWER button.

When preparing your load there are some important things to consider:

### **Sorting**

- Check the fabric care labels on the inside of garments to determine whether the item is suitable for tumble drying.
- It is best that you sort your garments into loads of similar items, and loads that take similar times to dry, before placing them in the dryer. Heavier items (eg towels, t-shirts and sheets) are best dried separately from lightweight items (eg synthetics and shirts). This prevents the possibility of some garments becoming over-dried whilst others are still damp. It will also help to extend the life of your clothing and linen.
- Drying your clothes as soon as you remove them from the washer will reduce the chance of wrinkles occurring and the chance of dye transfer from colored items to white items.
- We recommend that articles of clothing with screen-printing are turned inside out to minimize damage to the print. Garments with hooks or zippers should be fastened and where possible turned inside out.
- Use the drying rack to dry garments and items that could be damaged by tumbling or you do not wish to tumble, eg woolen garments, shoes, toys.

### **Before you load**

- Check pockets for items that could damage your clothes or get caught in the dryer.
- Close zippers, hooks and eyes, and other fastenings (ie fasten the openings of comforter covers), and remove loose bra wires. These may damage both your dryer and your clothes.
- Check the lint filter is clean.

### **To reduce wrinkling**

- Shake clothes out and load individually to help items dry evenly.
- Launder “permanent press” garments separately, eg business shirts.
- Allow enough room in the dryer for clothes to tumble freely.
- Use the WRINKLE FREE option.
- Hang garments as soon as the dryer cycle is complete to reduce the need for ironing.

### **Loading**

- Garments need to be loaded correctly to minimize creasing and wrinkling, and to ensure the load is dried evenly. Ensure there is plenty of room for the garments to tumble freely while drying. Load in terms of the space the garments take up when dry, rather than when they are wet.
- The general rule is that one wash load equals one dryer load. Do not overload your dryer, as it may damage your dryer and clothes.
- It is a good idea to dry “permanent press” type garments together on a separate cycle with the WRINKLE FREE option turned on. This will help reduce wrinkling and creasing and the need for ironing.

## **Important!**

- *Do not overload your dryer beyond its rated capacity.*
- *Never put dripping wet clothes in or on top of the dryer as excess water may cause an electrical hazard.*
- *Do not dry any electrical item in your dryer, including without limitation electric blankets.*
- *Do not dry curtains in your dryer. Sunlight makes them brittle and they may disintegrate during drying.*

## Drying times

- Drying very small loads is inefficient. Try to dry medium to large loads.
- Heavier items (jeans, sweatshirts) will take longer to dry than light items (synthetics, shirts).
- Spin clothes at the highest spin speed suitable for the load type. The more water you remove in the wash, the less drying time required.
- Care labels on garments provide valuable information about the fabric type and how the garment should be dried. Always follow the advice on the garment labels. Only dry items in this dryer that have a care label stating tumble drying is suitable.
- Separate colored items from whites where possible, especially when new. Color run may be an issue especially if you intend to delay the start of the drying cycle.

## Lint

Some items are lint givers, while others are lint collectors. Always dry lint givers and collectors separately.

Lint givers	Lint collectors
Towels	Synthetics
Flannel	Socks
Nappies	Polyester cottons

Delicate or easily damaged items (ie woolen or silk garments, nylon stockings, fine fabrics, delicate embroidered fabrics, garments with metal accessories) should be dried separately using the DELICATE cycle or the RACK DRY cycle where available (if you do not want them tumbled).

## Lint filter

Before you start your dryer you need to ensure the lint filter has been cleaned. AeroCare will flash the “Clean Lint Filter” signal light on the panel (above the START/PAUSE button) every time you turn your dryer on to remind you to clean the lint filter.

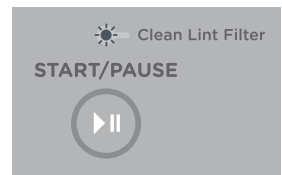

Fig.47 Clean lint filter signal light

## **Important!**

*It is important that you run your dryer with the lint filter in place AT ALL TIMES.*

## Dryer cycles

Your dryer has a number of DRYING CYCLES that can be used to dry different types of garments:

All drying cycles default to the recommended options for that cycle based on the average expected load to be dried using that cycle. You can vary the options (eg DRYNESS LEVEL, DRYING TEMP) to create your desired cycle. Refer to page 72.

Note: some options are not available on some cycles, for clothes care reasons, or because the option is not appropriate for the cycle.

To change a drying cycle or options you have selected after a cycle has started, touch START/PAUSE and select your new cycle and or settings, then touch START/PAUSE again to resume the cycle with the new setting(s). Some options may not be available for selection under certain conditions and after particular stages of the cycle have passed.

Always follow manufacturer's care label instructions when drying your garments. If you are unsure of the temperature to select for a load, it's best to select a cycle with a lower rather than a higher temperature, eg the DELICATE or EASY IRON cycle instead of the REGULAR cycle.

When drying casual, everyday garments we recommend using the EASY IRON cycle (with DRY drying temp selected). If this cycle is not offered on your model of dryer, use the DELICATE cycle.

Note: not all cycles and options may be available on your model of dryer. Default cycle settings are shown.

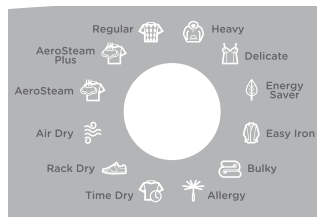

Fig.48 Drying cycles  
DE7027P, DG7027P

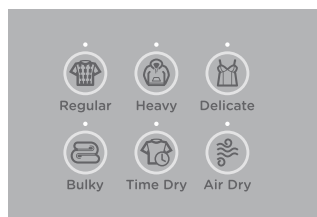

Fig.49 Drying cycles  
DE7027G, DG7027G



Regular

### Regular

A high heat cycle for rapid drying of everyday cottons. This cycle is suitable for most garments labelled "Tumble Dry".

Dryness Level	Dry
Drying Temp	High
Wrinkle Free	Off



## Heavy

### Heavy

An extended, high heat cycle designed for heavy fabrics and denims to ensure thick and bulky seams are thoroughly dried.

Dryness Level	Dry
Drying Temp	High
Wrinkle Free	Off



## Delicate

### Delicate

Extra care for delicate, heat sensitive items or fabrics recommending low heat. Also recommended for casual garments.

Dryness Level	Dry
Drying Temp	Low
Wrinkle Free	Off



## Energy Saver

### Energy Saver (selected models only)

An extended cycle with periods of no heating, reducing overall energy consumption.

Dryness Level	Dry
Drying Temp	Low
Wrinkle Free	Off



## Easy Iron

### Easy Iron (selected models only)

A medium heat cycle with WRINKLE FREE option, for extra care and to minimize wrinkles forming. Ideal for any garments that you may wish to wear immediately (eg casual items).

Dryness Level	Damp Dry
Drying Temp	Medium
Wrinkle Free	On

Note: fasten buttons before placing shirts in the dryer.

## Dryer cycles



**Bulky**

**Bulky**

A specialized cycle to care for bulky items, eg blankets, jackets, comforters.

Dryness Level Dry

Drying Temp Medium

Wrinkle Free Off

The BULKY cycle takes special care of bulky items. Bulky garments and bedding dry most effectively when they can move freely. Ensure that there is sufficient room in the drum for the load to move during drying.

For all bulky items:

- It is important that you check the care label of any item carefully, to ensure it is suitable for tumble-drying, before placing it into the dryer.
- Check bulky items during the cycle to ensure even drying. Reposition if necessary. For items containing down or feathers, place a damp towel tied in a knot in the dryer along with the item to help fluff the feathers.

When drying a single bulky item or blanket include 4 – 5 medium sized towels to provide cushioning. This will help to keep the item moving throughout the cycle.

### ***Important!***

*Dry bulky items thoroughly to prevent mildew from forming.*



**Allergy**

**Allergy (selected models only)**

A high temperature cycle to eliminate dust, mites and bacteria.

Dryness Level Extra Dry

Drying Temp High



Wrinkle Free Off

Note: the ALLERGY cycle is not recommended for garments prone to shrinkage or susceptible to heat damage (eg synthetics). Check the garments care label.



**Time Dry**

**Time Dry**

For clothes that you only want dried for a specific time period. A high heat cycle where the time can be adjusted using the MORE  (and where available) LESS  buttons.

Dryness Level	n/a*
Drying Temp	High
Wrinkle Free	Off



Note: the dryer dries for the selected time regardless of the level of moisture in your clothes. It is important to check your items throughout a TIME DRY cycle to avoid over-drying. The time includes a 5 minute cool down period at the end of the cycle.

We recommend that you dry your clothes for a slightly shorter time than you think they need, or check on them regularly (to avoid over-drying).



**Rack Dry**

**Rack Dry (selected models only)**



Specifically for use with the drying rack so you can dry items flat without them tumbling. eg shoes, hats, delicate jerseys. A 40 minute cycle with medium heat. Cycle time can be adjusted using the MORE  and LESS  buttons.

Dryness Level	n/a*
Drying Temp	Medium
Wrinkle Free	Off



**Air Dry**

**Air Dry**

A cool, 40 min cycle for drying items with no heat. Ideal for airing clean clothes or those that have been stored. Cycle time can be adjusted using the MORE  (and where available) LESS  buttons.

Dryness Level	n/a*
Drying Temp	No Heat
Wrinkle Free	Off

## Dryer cycles



### Aerosteam Plus

#### Aerosteam Plus (selected models only)

A cycle with a short burst of heat and steam followed by a fixed period of air dry (no heat). Designed for larger loads of wrinkled garments and to freshen items that have been stored. Recommended for 7 – 13 garments. Not intended for use with towels, heat sensitive, delicate or bulky items.

Dryness Level n/a\*

Drying Temp High, followed by no heat

Wrinkle Free Off



### Aerosteam

#### Aerosteam (selected models only)

A cycle with a short burst of heat and steam followed by a fixed period of air dry (no heat). Designed for 3 – 5 garments or items that are wrinkled or to freshen items that have been stored. Not intended for use with towels, heat sensitive, delicate or bulky items.

Dryness Level n/a\*

Drying Temp High, followed by no heat

Wrinkle Free Off

\* Dryness level is an option available on automatic sensing cycles only. On manually timed or pre-programmed cycles dryness will vary depending on the load and its initial moisture content.



Note: if items are still damp at the end of a steam cycle, select the AIR DRY cycle to finish drying the items. To freshen towels, heat sensitive, delicate or bulky items, use the AIR DRY cycle only.



### **Important!**

- *Ensure the water supply to the dryer is connected and turned on before using the AEROSTEAM or AEROSTEAM PLUS cycles.*
- *DO NOT start an AEROSTEAM or AEROSTEAM PLUS cycle if there is no load in the drum. Make sure you have loaded the dryer before starting an AEROSTEAM or AEROSTEAM PLUS cycle.*

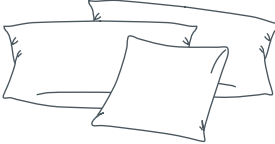
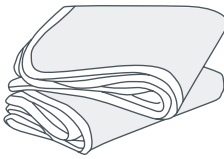

There are some articles that need to be dried in a special way. Before you dry any item that is not described in AeroCare's cycles (refer to pages 58 to 62), refer to the table below. Always remember to follow the manufacturer's instructions (please read the care label of the item).

Item	Special instructions
<p><b>Pillows</b></p> 	<p>Check the care label – can the pillow be dried in the dryer?</p> <p>Do not dry foam rubber pillows.</p> <p>Check for weak seams where feathers or fillings could escape.</p> <p>Dry only one average-sized pillow at a time.</p> <p>Select the BULKY cycle.</p> <p>Check the pillow at regular intervals.</p> <p>Note: It is important to ensure the pillow is completely dry to prevent mildew from forming.</p>
<p><b>Blankets/throws</b></p> 	<p>Check the care label – can the blanket be dried in the dryer?</p> <p>Include 4 – 5 medium sized towels along with the blanket for cushioning. This will help stop shrinkage from over-tumbling.</p> <p>If you are drying more than one blanket, ensure the blankets do not fill more than half of the dryer, otherwise there will not be enough space for them to tumble.</p> <p>Select the BULKY cycle.</p> <p>On completion, remove the blanket, shake and, if needed, stretch the blanket back to its original shape.</p> <p>Note: It is important to ensure the blanket is completely dry to prevent mildew from forming.</p>
<p><b>Plastic, foam rubber, and rubber-backed products</b></p>	<p>Do not dry products containing foam rubber, plastic or rubber on any cycle other than AIR DRY.</p> <p>Drying these types of garments on any cycle other than AIR DRY is a fire hazard.</p>
<p><b>Jackets</b></p> 	<p>Check the care label – can the jacket be dried in the dryer?</p> <p>Check that all zippers and/or buttons are fastened.</p> <p>Select the BULKY cycle.</p>

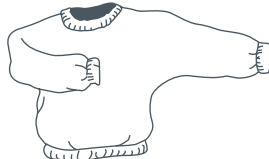
Item	Special instructions
<p><b>Extra large items</b> (including bedspreads and comforters)</p> 	<p>Check the care label – can the item be safely dried in the dryer?</p> <p>We recommend using the BULKY cycle. Note: we recommend drying synthetic-type comforters and bedspreads using the AIR DRY cycle ONLY.</p> <p>It is best to check the item halfway through the cycle to ensure even drying.</p> <p>If the item contains feathers or down, add a heavy item (eg a towel tied in a knot) to the load to help ‘fluff’ the item.</p> <p>Ensure the load does not sit higher than level with the top edge of the door handle (close the door to assess this) before starting the cycle.</p>
<p><b>“In Dryer” dry-cleaning products</b></p>	<p>Ensure the dry-cleaning product is recommended for use in a domestic dryer.</p> <p>Follow the manufacturer’s instructions for how to prepare the load.</p> <p>Set the dryer to the EASY IRON cycle, this cycle uses a medium heat. If this cycle is not offered on your model of dryer, use the DELICATE cycle.</p> <p>At the end of the cycle remove the dry-cleaning product from the machine and continue to follow the dry-cleaning product’s instructions.</p>
<p><b>Delicates, fine fabrics</b></p> 	<p>Check the care label – can the item be dried in the dryer?</p> <p>Use a low heat setting (or no heat). We recommend the DELICATE, or RACK DRY cycle (for items too delicate to tumble).</p>
<p><b>Woolens, silks</b></p> 	<p>Check the care label – can the item be dried in the dryer?</p> <p>Use the drying rack – place item(s) flat on the rack.</p> <p>Use the RACK DRY cycle (selected models only).</p>
<p><b>Soft toys, shoes</b></p> 	<p>Use the drying rack – sit item on the rack.</p> <p>Use the RACK DRY cycle (selected models only).</p>

Once you have selected your drying cycle you may wish to change the default drying options.

## Dryness Level

Your AeroCare dryer takes the guess work out of choosing drying times by sensing the dryness of the load. When your dryer senses that the clothes have dried to the dryness level you have selected, the dryer will automatically turn off.

AeroCare offers up to four dryness levels to choose from, depending on what dryer model you have. This allows you to customize how dry you would like your load to be at the end of the cycle.

Choose the dryness level to suit your load depending on how dry you wish your clothes to be. If you find the load is not dry enough, select the next dryness level up. The higher the level, the longer the drying time and the drier your clothes will become.

Damp	Damp Dry (selected models only)	Dry	Extra Dry
Suitable for delicate light-weight fabrics and garments you may wish to iron dry	An ideal setting for lightweight cotton items that you want less dry	Designed to provide items dry enough to be worn immediately	Useful for drying items that you wish to store (cupboard dry)

If items are still damp, or too dry at the conclusion of the cycle, next time try a different dryness level setting to customize the dryness level to your personal preference.

## Cooling

When the dryer has sensed that the load is dry it will automatically go into a cool-down phase. During COOLING the drum tumbles and cool air is blown through the clothes. This reduces wrinkling if the clothes are left in the dryer after the cycle has completed.

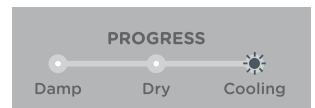

Fig.50 Cooling

## Drying Temp

- There are up to four drying temperatures you can choose from: High, Medium, Low, Extra Low (available on selected models only).
- Each drying cycle is set to a default temperature to ensure the best possible fabric care for your clothes.
- To select a different drying temperature, touch the DRYING TEMP button until the light next to your desired drying temperature is illuminated.

Note: not all temperatures are available on all cycles, for clothes care reasons.



Fig.51 Drying temperature options

## Wrinkle Free

Select the WRINKLE FREE if you wish to minimize wrinkling. At the end of the cycle, the drum will rotate for 30 seconds every 5 minutes circulating cool air through the load to minimize wrinkling and creasing. This is particularly useful if you cannot remove the items immediately after the cycle ends.



WRINKLE FREE can be selected on any cycle (except ENERGY SAVER, RACK DRY and AIR DRY) and can be turned ON or OFF at any time during the cycle by touching START/PAUSE, then WRINKLE FREE to OFF. WRINKLE FREE will operate for a maximum of 24 hours if not stopped beforehand. To stop WRINKLE FREE at any time touch START/PAUSE, or open the door. You can then remove your items. Touch POWER to stop the cycle and turn the dryer off.

After completing each tumble AeroCare will beep to remind you that the load is dry and can be removed.

Note: WRINKLE FREE is automatically selected on the EASY IRON cycle.

## Delay Start (selected models only)

The DELAY START option enables you to delay the start of the drying cycle from between five minutes and 18 hours. Time delays you can select are 5 mins, 15 mins, 30 mins, 1 hour, and then hourly up to 10 hours, then for either 12 hours, 15 hours or 18 hours. This can be useful to time your drying to finish when you arrive home from work, or to start when power rates are lower.

To program a DELAY START, simply touch the DELAY START option button to select ON, then the MORE  button to increase the delay time and LESS  button to decrease the time. Touch START/PAUSE to confirm your selection and start the countdown. Once started, the time will countdown on the digital display panel in one minute increments (or one hour increments when the DELAY START time selected is greater than 10 hours). The START/PAUSE light will stop flashing and turn on solid. The dryer will tumble periodically during the delay start countdown.

Touch the DELAY START button to turn DELAY START off.

To cancel a delay start time once it is counting down, simply touch START/PAUSE, then touch the DELAY START button to select OFF to disable the feature. Touch START/PAUSE to start the cycle immediately.

Note: we strongly recommend that you avoid using DELAY START for damp, non-colorfast items as this may cause dye to transfer from one item to another.

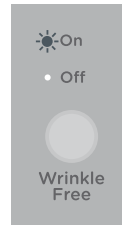

Fig.52 WRINKLE FREE option ON

## **Damp/Dry Signal (selected models only)**

When your load reaches the DAMP/DRY stage, the dryer will play a musical series of beeps to alert you to remove any items you wish to, and then continue drying until your load reaches the dryness level you selected. This reminds you to remove some items in your load before they become dry, so is ideal for items that tend to crease easily and require ironing, or may shrink when tumble dried.

## Starting a drying cycle

Once you have chosen all your desired settings, ensure the door is closed and touch START/PAUSE (located on the right-hand side of the control panel).

## Stopping your dryer

Your AeroCare dryer can be stopped during any stage of the drying process, to allow you to check on your load or add/remove clothes. To do this, simply open the dryer door or touch START/PAUSE and open the door. There will be a slight delay as the drum slows down and stops. To restart your dryer, close the door and touch START/PAUSE.

## ***Important!***

***If you wish to stop the dryer before the cycle is finished, you MUST remove the clothes IMMEDIATELY and spread them out to cool. DO NOT leave the clothes in the dryer or bunched up in a clothes basket. There is a risk of spontaneous combustion.***

If the cycle is interrupted before it progresses into COOLING, the clothes and parts of the drum may be extremely hot. Take extreme care when removing the clothes load.

## Finishing your cycle early

AeroCare will advance through the progress lights as it dries and will switch off once it has completed the COOLING (final) phase of the cycle.

The COOLING phase means the heating elements switch off and the clothes are tumbled without heat. When AeroCare senses the clothes are cool, the dryer will automatically end the cycle (this takes between two and 10 minutes depending on the size of your load).

If you wish to finish your drying cycle early you can pause the current cycle and select the AIR DRY cycle (select a cycle time of at least 10 minutes to cool the load down before removing it from the dryer).

## Beeps

At the end of the cycle, the dryer will beep to alert you that the load has completed drying. You can modify the number of beeps that sound, or for the dryer to not beep at all. The dryer defaults to five beeps. Please refer to page 74 for details on modifying the number of end of cycle beeps.

## Drying times

Operation of the dryer and drying times of clothes loads can be affected by a number of factors including (but not limited to):

- The drying cycle chosen
- Load size
- Size of the items
- Type of fabric
- Load wetness
- Location of the dryer
- Ambient/environmental conditions
- Venting method
- Heat used (electric, natural gas or LP gas)
- Condition of exhaust ducts

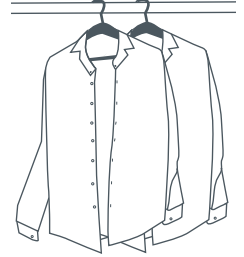









## Fabric softener sheets





If you want to use fabric softener sheets, you must ensure that they are labeled “dryer safe”. Always follow the manufacturer’s instructions on the packaging. Do not place them in a dryer with warm clothes as there is a chance the fabric softener in the sheet may stain your clothes. Only use a softener sheet once, then discard it.

## Care labels

Below is a selection of care label symbols that garment manufacturer's use to show how their garments should be dried. We've converted these symbols into the cycles and heat settings that we recommend you use in the AeroCare dryer. By following our recommendations, you can ensure that your clothes will retain their appearance over time.

Tumble dry symbols	Normal 	Permanent Press 	Delicate 	Do not tumble dry 
Drying cycle we recommend	REGULAR, HEAVY, ENERGY SAVER	EASY IRON	DELICATE	Do not place in dryer

Tumble dry symbols	Any heat 	High 	Medium 	Low 	No heat 
Drying cycle we recommend	Any cycle	REGULAR, HEAVY, ALLERGY	EASY IRON, BULKY	DELICATE	AIR DRY, RACK DRY

Additional drying instructions	Hang to dry (line dry) 	Drip dry 	Dry in shade 	Dry flat 
--------------------------------	---	---	---	---

Do not place articles with these symbols in the dryer.



The drying rack helps to dry items such as sports shoes, sweaters, hats and stuffed toys – all those delicate items that are best dried without tumbling.

Always use the drying rack when using the RACK DRY cycle where available. Also use a low temperature (a maximum of MED drying temp can be selected only).

If the RACK DRY cycle is not available use TIME DRY and select LOW temperature. Do not exceed MED drying temp.

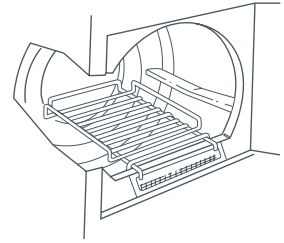

Fig.53 Drying rack

To install the drying rack, guide the rack (with the end of the rack with the hooks extending closest to you) into the dryer. Hold the back of the rack up towards the top of the drum and hook the rack into the lint filter housing (with the lint filter in place). Lower the rack so the longer 'legs' slide down and sit against the front inner of the drum. Ensure the rack sits horizontally in place.

Do not use the AUTOMATIC CYCLES (ie REGULAR, HEAVY, DELICATE, ENERGY SAVER, EASY IRON, BULKY, ALLERGY) when using the drying rack, as the dryer is unable to sense articles placed on the drying rack and therefore cannot determine when articles are dry. Use the RACK DRY cycle when placing items on the drying rack, ensure they do not hang over the edge of the drying rack, as this may result in damage.

The drying rack is available as an accessory. Drying rack part number: WC212D1411G002

### ***Important!***

- *Check articles regularly throughout the cycle to avoid over-drying.*
- *Do not put other items in the dryer while you are drying items on the drying rack.*

## To customize a cycle

You can program your AeroCare dryer to remember the drying options you prefer for each drying cycle. For instance, you may want to set the REGULAR cycle to operate the WRINKLE FREE option every cycle, or set the TIME DRY cycle to a lower DRYING TEMP.

- 1 Touch POWER.
- 2 Select the cycle you wish to customize.
- 3 Touch and hold the button of the preferred option you want to customize, eg DRYING TEMP, for **three seconds**. You will hear two quick beeps and the cycle icon will flash. The screen will display "Set".
- 4 Select your preferred setting for this option, and any other options you wish to customize for the cycle (ie you can customize other options at this point also).  
Note: some options may not be selectable for clothes care reasons. The dryer will beep to alert you when settings cannot be selected for that cycle.
- 5 Touch the START/PAUSE button to store your customized cycle. A long beep will sound to confirm that your changes have been saved.

To modify your customized drying cycle again, simply repeat these steps. To return all drying cycles to their factory default settings, please refer to page 74.



Fig.54 Customizing a drying cycle, eg customizing the WRINKLE FREE option to operate for every REGULAR cycle

Note: the control panel may differ depending on what model of dryer you have

## Changing pre-set options

### Option Adjustment mode

In this mode you can modify the number of beeps that sound at the end of the cycle (ie end of cycle (EOC) beeps), and reset the dryer to the settings it left the factory with (factory reset).

Note: DRYNESS LEVEL and DRYING TEMP settings cannot be modified.

### To enter Option Adjustment mode

- 1 Turn the machine on at the wall but do not touch the POWER button. **Touch and hold the KEYLOCK and START/PAUSE buttons for three seconds.** You will hear three quick beeps indicating you have entered Option Adjustment mode. The diagram below shows how the drying cycle icons relate to the options you can change. Page 74 explains the options in more detail.
- 2 Use the dial and buttons on the control panel to make your changes to the pre-set options.
- 3 Touch POWER to return to normal mode when you have finished modifying your options. Your dryer will automatically remember your changes.

### Adjusting your options



- 1 Enter the Option Adjustment mode (refer above).
- 2 The diagram below shows how the drying cycle icons relate to the options you can change. The two options (the number of end of cycle beeps, and resetting the factory defaults) you can adjust are accessible using the HEAVY and DELICATE cycles.
- 3 Use the MORE  (and where available) LESS  buttons underneath the digital display to scroll through the available settings of your selected option.



Fig.55 Option Adjustment mode

## End of cycle beeps

The beeps signalling the end of the cycle can be set to 0 (no beeps), 5 beeps or 15 beeps. The default setting is 5 beeps.

**To modify the number of beeps sounding at the end of the cycle:**



- 1 Enter Option Adjustment mode (refer to page 73).
- 2 Select the HEAVY cycle.
- 3 Touch the MORE  (or where available) LESS  buttons to increase the number of beeps, or for no beeps to sound at the end of the cycle.
- 4 Touch POWER to save your settings.



Fig.56 Adjusting the end of cycle beeps

## Factory reset

You can reset your dryer to the default settings it left the factory with.

**To reset your dryer to its factory settings:**

- 1 Enter Option Adjustment mode (refer to page 73).
- 2 Select the DELICATE cycle.
- 3 The display will show "rSt". Touch and hold the START/PAUSE button for three seconds to reset your dryer to its factory settings.

Note: this action will reset the dryer to the default settings, exit Option Adjustment mode and power off your washer.

Touch POWER to exit if you do not wish to reset your dryer.



Fig.57 Resetting back to the factory settings

Remember, to save changes and exit from the Option Adjustment mode at any time (ie return to normal operating mode), touch the POWER button.

Clean your dryer with a soft damp cloth and wipe dry. Do not use scouring cleaners as they can damage the paint and plastic surfaces.

Before you start cleaning your AeroCare dryer, ensure that it is disconnected from the power (ie remove the plug from the power outlet), or that KEYLOCK has been activated (refer to page 55).

## Interior

The drum is rust-resistant. However, colored fabrics which lose color or bleed during washing may cause discoloration of the dryer drum. We recommend that the dryer drum be cleaned with a cloth using a paste made from detergent and water, or a non-abrasive cleaner. Complete the cleaning by thoroughly wiping the drum with a moist cloth, and then drying several wet rags or old towels for 20 to 30 minutes using the TIME DRY cycle before using the dryer normally.

## Exterior

Wipe off any spills or washing compounds/products. Wipe or dust with a damp cloth. Do not strike the surface with sharp objects. Pre-treatment products may damage parts of your dryer. Please treat soiled or stained items where the pre-treatment will not come in contact with dryer surfaces.

## Cleaning the control panel and machine top

Use a soft damp cloth to wipe all surfaces, and wipe dry. Avoid using chemical or scouring cleaners, as these will damage the paint and plastic surfaces of your dryer.

## **Important!**

*The SmartTouch™ Control Dial (selected models only) is not designed to be removable for cleaning. Do not attempt to remove the dial.*

## Pre-treatment sprays

Do not use pre-treatment sprays or liquids on or near your dryer as they can damage your machine's control panel as well as any of its plastic parts. Damage to your dryer caused by pre-treatment products will not be covered by the limited warranty.

## Stains

If stains appear inside the drum of your machine, mix a detergent with water to create a paste (or use a non-flammable liquid cleaner) and wipe over the stain with a soft cloth. Then dry several wet rags or old towels for 20 to 30 minutes using the TIME DRY cycle to remove all traces of the cleaner.

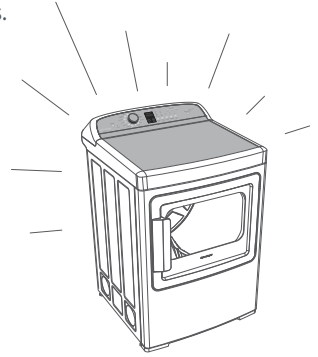

**Lint filter**

Lint is generally formed during wearing and washing. Lint and fibers released from clothes during the drying cycle are collected in the lint filter.

It is important to clean the lint filter after every load, as the lint produced in the drying process can become a fire hazard if it is allowed to accumulate in or around your dryer. AeroCare will flash the "Clean Lint Filter" signal light on the panel each time you power your dryer on to remind you to clean the lint filter.

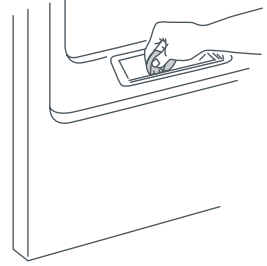

Fig.58 Cleaning the lint filter

Remove the lint filter from the housing and wipe the surface with your fingers. It is easier to remove the lint when your fingers are moistened. A clean lint filter will ensure your clothes remain lint-free and your dryer will operate at maximum efficiency.

Be sure to replace the lint filter before using the dryer.

**Important!**

*If the lint filter becomes damaged, contact Fisher & Paykel (refer to page 86) to arrange getting a new filter. Do not operate your dryer with a damaged lint filter or without the lint filter in place, as this will cause damage to your dryer.*

**Exhaust duct**

The dryer exhaust ducting must be inspected and cleaned periodically by an Authorized Service Agent to remove accumulated lint and prevent clogging. This will help keep your dryer operating at optimum performance. A partially clogged exhaust can lengthen the drying time.

**To clean the exhaust duct follow these steps:**

- 1 Turn off the electrical supply by disconnecting the plug from the power socket.
- 2 Disconnect the exhaust duct from the dryer.
- 3 Vacuum the exhaust duct with the hose attachment or attach a rag to a pole or drain cleaning wire and clean the duct.

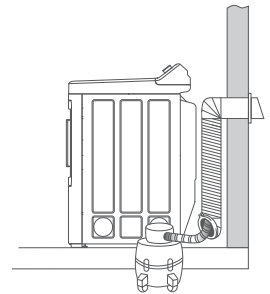

Fig.59 Cleaning the exhaust duct

## Exhaust hood

- Ensure the inside flaps or any damper on the exhaust hood moves sufficiently and opens and shuts freely (you may want to check with a mirror).
- Make sure inside flaps are fully open when dryer is operating.
- Make sure there is not wildlife (birds, insects, etc) nesting inside the exhaust duct or hood.

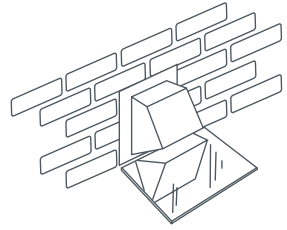

Fig.60 Checking the exhaust hood

## Venting

For best drying performance, the dryer needs to be properly vented.

### Ensure:

- Only rigid metal or flexible metal 4" (102 mm) diameter ductwork has been used inside the dryer cabinet or for exhausting to the outside.
- The shortest length possible has been used.
- The exhaust duct is not crushed or collapsed.
- The duct is not resting on sharp objects.
- Plastic or other combustible ductwork has NOT BEEN USED.

Carefully follow the details on exhausting the dryer in the "Installation instructions". Refer to page 26.

Ensure that the area around the dryer is kept clear and free from combustible materials, gasoline and other flammable vapors or liquids. Ensure also that the dryer area is kept clear and free from items that would obstruct the flow of combustion and ventilation air.

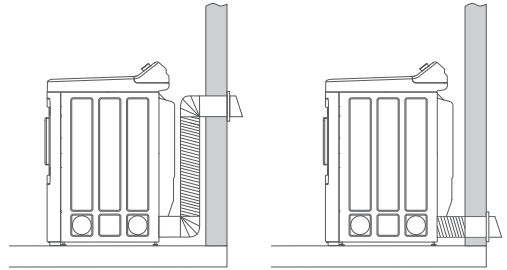

Correct venting

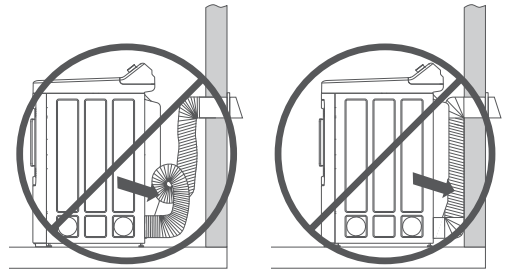

Incorrect venting

Fig.61 Correct and incorrect venting

## Important!

Venting must conform to local building codes.

## User warnings

Your dryer is capable of diagnosing a number of its own problems. A continuous series of beeps will sound and a code will be displayed when it has a problem that you can correct yourself. All control panel lights will turn off and a code will be displayed to inform you what the problem is. To stop the beep sounding, press any button on the control panel. Do not try to continue your drying cycle once you stop the noise. You must address the problem the dryer is alerting you to.

Check this chart before you call for service.

Description	Displayed as	What should you do?
The door is not closed		<p>Close the door fully and touch START/PAUSE.</p> <p>Try opening and closing the door again.</p> <p>Reposition the load, make sure the load is correctly in the drum and that no items are caught in the way of the door.</p>

Once you have addressed the issue the user warning was alerting you to, try using your dryer normally.

If the symptom persists, call your Fisher & Paykel Authorized Service Agent (refer to page 86).

## Fault codes

When a continuous series of beeps is sounded, all the lights turn off on the control panel and a number appears on the display; a fault has occurred. The dryer will automatically enter this mode if a fault occurs. The fault code will be displayed as a number on the digital display. To stop the sound, touch any button and perform the following steps:

- 1 Unplug your dryer from the power outlet.
- 2 Wait one minute and plug the dryer back in.
- 3 Check the dryer is correctly level (refer to page 44).
- 4 Remove your dryer load and retry.
- 5 Perform a TIME DRY cycle (20 mins).
- 6 If the fault re-occurs repeat steps 1 and 2.
- 7 If the machine still will not work you will be required to call a Fisher & Paykel Authorized Service Agent to arrange service (refer to page 86). Record the fault code number displayed and the serial number of your dryer (located on the drum opening surround (open the door)) before calling. The fault code will indicate to the Service Agent what the problem could potentially be.

If a fault code is being displayed, you can still turn your dryer off by pressing POWER.



The following is a list of problems you may encounter when using this appliance and some suggestions that may help to correct the problem. If you still have problems, please contact a Fisher & Paykel Authorized Service Agent.

## **Pressing POWER does not turn on the dryer**

Is the electrical cord plugged in? If not, plug the cord in.

If there is a switch at the power point, is it switched on?

Could your household power supply be at fault? If your plug is suitable, try plugging another electrical appliance into the same outlet.

Turn off the power at the power point. Unplug the dryer from the wall. Wait 60 seconds, plug it back in, turn it on and try again.

Check your house circuit breakers and fuses. If they are at fault contact an electrician.

Is the power cord damaged?

## **Dryer does not heat**

Is the dryer set to the AIR DRY cycle?

Is the gas turned on (gas dryers only)?

Has the dryer progressed to COOLING? Check the progress lights.

If the problem persists call for service.

## **Pressing START / PAUSE does not start the drying cycle**

Did you touch START/PAUSE firmly enough?

Is the dryer paused? If so, the START/PAUSE light will be flashing.

Is the dryer door closed properly?

Is there a user warning or fault code displayed on the control panel? Refer to page 78.

Is the dryer making a beeping noise? Refer to page 81.

Has the lint filter been emptied?

Is the lint filter in place?

Has the dryer been overloaded?

Is DELAY START set?

## **Dryer keeps stopping and starting**

Has WRINKLE FREE been turned on? WRINKLE FREE ON is the default setting for the EASY IRON cycle, meaning the drum will rotate periodically after the cycle has finished to minimize wrinkling.

**Dryer stops working mid cycle**

Is there a fault code or user warning displayed on the digital display panel? Is the machine beeping?

Was there a power failure? If so, when power resumes, you will need to reselect your chosen drying cycle and touch START/PAUSE to resume the cycle.

Has the dryer been paused?

Is the door open?

**Drying is taking too long**

Have you selected an appropriate cycle for the load?

What dryness level did you select?

Try selecting a lower/higher temperature.

Is the dryer overloaded for the cycle?

Try dividing the load in half and dry half at a time.

Is the lint filter blocked? Check this does not need to be cleaned.

If you have a gas dryer, is the gas turned on? Could your gas supply be at fault?

What environmental conditions are you using the dryer in? Hot, humid conditions may cause the dryer to become less efficient and take longer to dry a load. High altitude will also affect your dryers performance, including making your drying cycle longer.

How wet was the load when you put it in? It might require water being hand-wrung or machine-spun out of the load before drying.

Is the airflow system free from obstruction?

Has the dryer been exhausted correctly? Is the exhaust duct distance too great?

Were items getting wrapped up inside other items? Separate items and dry items of similar 'weight' together.

Open items out when you place them in the dryer. Do not fold them up. Untangle items, eg pull long sleeves out so they are not stuck on the inside of the garment.

**Items got too hot or damaged**

Did you select the appropriate cycle and options for the items?

Did you remove the items before the end of cycle cool down? This may damage clothing if items are not spread out and exposed to air to cool once removed from the dryer.

## **Dryer is beeping, displaying unfamiliar light patterns and/or a message on the digital display**

See the USER WARNINGS and FAULT CODES sections (refer to page 78).

Try turning the dryer off, waiting 30 seconds and turning it back on.

## **Cycle time longer than usual / Inaccurate time remaining/ Adjustment of time remaining during the cycle**

Cycle time is approximate and may be affected by the composition and size of the load, how dry the load was to begin with, environmental conditions, cycle and options selected, sensing while drying and any interruptions during the cycle (refer to page 54).

## **Noises**

Have you overloaded the machine?

Continuous beeping or a musical series of beeps with a message displayed on digital display (refer to page 78).

End of cycle beeps – These can be turned off (refer to page 74).

## **Cannot see steam at start of cycle, or at any time during the cycle (selected models only)**

The release of steam occurs at different times in the cycle and may not be visible.

Check whether the steam nozzle might be blocked from impurities in the water supply. You may be required to call an Authorized Service Agent to replace this.

## **Water visible on inside of door and lint filter after steam cycle (selected models only)**

Steam produced during the cycle may condense in these locations and is normal.

## **Water drips from inside of door after steam cycle (selected models only)**

Steam produced during the cycle may condense on the inside of the door. This is normal operation of the dryer.

## **Puddle of water on the floor in front of the dryer after using a steam cycle**

Have you used a large enough load for the steam cycle you have selected? Refer to page 62.

Try adding more items to the dryer.

## **Puddle of water on the floor at the rear of the dryer**

Check the inlet hose connection. Tighten if necessary.

Check that the rubber washer is installed in the inlet hose.

**Linting**

Has the lint filter been cleaned and replaced correctly?

Was the dryer overloaded?

Have you separated lint-shedding garments (eg towels) from lint receiving garments (eg synthetics).

Have you checked your pockets for tissues or other items that could have been left in them?

Dry similar colors together (eg light items with light items, dark items with dark items).

Have you over-dried your load? Over-drying can cause lint-attracting static electricity. Try a lower dryness setting or use an AUTOSENSING cycle instead of TIME DRY.

Were new items (eg towels, flannelette sheets) dried in your dryer recently? Refer to “Caring for your dryer” page 75.

**Static problems**

Have your clothes been over-dried? Select a lower dryness setting.

Have you used fabric softener? Place fabric softener sheets in the dryer.

**Fabric damage**

Has the load been over-dried? Select a lower dryness setting.

Is tumble drying recommended for the item? Check the care labels inside garments.

Did you follow the instructions on the care label of clothing for tumble drying correctly?

Were delicate items dried separately on the DELICATE cycle or the RACK DRY cycle?

Were there metal parts on the items? Were zips and other clasps done up?

Were items separated and dried on an appropriate cycle for the fabric type?

If using the RACK DRY cycle, did items fall off the rack?

Was an appropriate drying temperature and dryness level selected for the fabric type?

Did you monitor the dryness of clothes if dried on a TIME DRY cycle?

Did you remove the items before the end of cycle cool down? This may damage clothing if it is not spread out and exposed to air to cool once removed from the dryer.

**Dye transfer**

Remember to separate whites and colors.

Do not leave wet items sitting in the dryer for long periods before drying, if they are prone to color run. If you do intend to leave them for long periods before drying, then separate the load and put color run items aside.

## **Tangling**

Try separating out larger items from smaller items.

Load items individually and loosely into the dryer and do not fold the items.

Try using the EASY IRON cycle to dry shirts (where available).

Try drying smaller load sizes.

Dry pantyhose, bras and any other delicate items prone to tangling in a delicates bag or on the RACK DRY cycle. Note: items may not dry as well in a delicates bag.

Dry sheets and comforter covers separately from other laundry.

Ensure comforter covers are buttoned or domed closed before drying.

## **Clothes are wrinkled**

Was the washer or dryer overloaded? Decrease the load size.

Selecting the EASY IRON or REGULAR cycle on MED temp will minimize creasing.

Did you remove your clothes as soon as the dryer was finished? Use the WRINKLE FREE option, if you cannot return to the dryer in time.

Have your clothes been over-dried? Select a lower dryness level. Check your garments care labels.

Try not to leave wet clothes sitting in the dryer for a long period before starting it.

## **Damp patches on items after using a steam cycle**

Steam may condense inside the drum which your items may come in contact with. Add more items to the dryer if this occurs.

## **Items wrinkled even after using one of the steam cycles**

Are there too many items in the load? Reduce the number of items.

## **Items in the dryer are wet after using one of the steam cycles**

Are there enough items in the load? Add more items.

Check the lint filter is clean.

Use the AEROSTEAM cycle if you are drying childrens' and infants clothing.

## Limited warranty

When you purchase any new Fisher & Paykel AeroCare dryer product for personal or consumer use you automatically receive a two year limited warranty covering parts and labor for servicing within the 48 mainland United States, Hawaii, Alaska, Washington DC and Canada. Products for use in Canada must be purchased through the Canadian distribution channel to ensure regulatory compliance.

### **Fisher & Paykel undertakes to:**

Repair or at its option replace without cost to the owner either for material or labor any part of the product, the serial number of which appears on the product, which is found to be defective. In Alaska, you must pay to ship the product to the service shop or for the service technician's travel to your home. If the product is installed in a motor vehicle, boat or similar mobile facility, you must bring it to the service shop at your expense or pay for the service technician's travel to the location of the product. If we are unable to repair a defective part of the product after a reasonable number of attempts, at our option we may replace the part or the product, or we may provide you a full refund of the purchase price of the product (not including installation or other charges).

This limited warranty extends to the original purchaser and any succeeding owner of the product for products purchased for ordinary single-family home use.

All service under this limited warranty shall be provided by Fisher & Paykel or its Authorized Service Agent during normal business hours.

### **How long does this limited warranty last?**

Our liability under this limited warranty expires two years from the date of purchase of the product by the first consumer.

Our liability under any implied warranties, including the implied warranty of merchantability (an unwritten warranty that the product is fit for ordinary use) may expire two years (or such longer period as required by applicable law) from the date of purchase of the product by the first consumer. Some States do not allow limitations on how long an implied warranty lasts, so this limit on implied warranties may not apply to you.

**This limited warranty does not cover:**

- A** Service calls that are not related to any defect in the product. The cost of a service call will be charged if the problem is not found to be a defect of the product. For example:
  1. Correcting faulty installation of the product.
  2. Instructing you how to use the product.
  3. Replacing house fuses, resetting circuit breakers, correcting house wiring or plumbing, or replacing light bulbs.
  4. Correcting fault(s) caused by the user.
  5. Changing the set-up of the product.
  6. Unauthorized modifications of the product.
  7. Noise or vibration that is considered normal, for example, drain/fan sounds or user warning beeps.
  8. Correcting damage caused by pests, for example, rats, cockroaches etc.
- B** Defects caused by factors other than:
  1. Normal domestic use or
  2. Use in accordance with the product's user guide.
- C** Defects to the product caused by accident, neglect, misuse, fire, flood or Act of God.
- D** The cost of repairs carried out by non-authorized repairers or the cost of correcting such unauthorized repairs.
- E** Travel fees and associated charges incurred when the product is installed in a location with limited or restricted access (eg airplane flights, ferry charges, isolated geographic areas).
- F** Normal recommended maintenance as set forth in the product's User Guide.

If you have an installation problem contact your dealer or installer. You are responsible for providing adequate electrical, exhausting and other connection facilities.

We may not be responsible for consequential or incidental damages (the cost of repairing or replacing other property damaged if the product is defective or any of your expenses caused if the product is defective). Some States do not allow the exclusion or limitation of incidental or consequential damages, so the above limitation or exclusion may not apply to you.

## How to get service

Please read your User Guide. If you then have any questions about operating the product, need the name of your local Fisher & Paykel Authorized Service Agent, or believe the product is defective and wish service under this limited warranty, please contact your dealer or call us at:

### USA and Canada

TOLL FREE 1.888.9.FNP.USA (1.888.936.7872)

or use the link at: [www.fisherpaykel.com/locator/servicer/](http://www.fisherpaykel.com/locator/servicer/)

You may be required to provide reasonable proof of the date of purchase of the product before the product will be serviced under this limited warranty.

## Commercial use

If you are using the product in a commercial setting (any use other than a single family dwelling), we agree to repair or replace, without cost to you for parts only, any defective parts, the serial number of which appears on the product. Our liability for these repairs expires ONE YEAR from the date of original purchase.

At our option we may replace the part or the product, or we may provide you a full refund of the purchase price of the product (not including installation or other charges). All service under this limited warranty shall be provided by Fisher & Paykel or its Authorized Service Agent during normal business hours.

## No other warranties

This limited warranty is the complete and exclusive agreement between you and Fisher & Paykel regarding any defect in the product. None of our employees (or our Authorized Service Agents) are authorized to make any addition or modification to this limited warranty.

Warrantor: Fisher & Paykel Appliances, Inc.

If you need further help concerning this limited warranty, please call us at above number, or write to:

Fisher & Paykel Appliances, Inc.  
695 Town Center Drive, Suite 180  
Costa Mesa  
CA 92626

This limited warranty gives you specific legal rights, and you may also have other rights which vary from state to state.









[www.fisherpaykel.com](http://www.fisherpaykel.com)

*Fisher & Paykel*



234D1668P009

Copyright © Fisher & Paykel 2015. All rights reserved.

The product specifications in this booklet apply to the specific products and models described at the date of issue. Under our policy of continuous product improvement, these specifications may change at any time. You should therefore check with your Dealer to ensure this booklet correctly describes the product currently available.