













FULGOR

MILANO

600 Series PRO 30" Self Cleaning Single Wall Oven

F6PSP30S1



Series		600 PROFESSIONAL
Type		PYRO
Size		30"x30"
Colour		SS
Stainless Steel Aesthetics		Embossed window profile with bended edges
Oven Type		Multifunction 2 Fans (True Euro Convection)
Temperature Regulation		Electronic
Functions		
Pyrolitic Self-Clean with automatic door latch		•
True European Convection Bake (Multi level)		•
Convection Broil		•
Convection Roast		•
Pizza (Lower Convection)		•
Bake		•
Broil		•
Dehydrate		•
Thaw (Defrost)		•
Proof (Warm)		•
Keep warm (Warm Plus)		•
Oven Lights		•
Fast Preheat		•
Control Panel		
Control type		HAWK3TC - Electronic
Clock/Timer Display		White LED
Temperature Display		White LED
Function Display		White LED
Commands		2 Knobs / 6 Touch Keys
Language		English
Special Features		
Preset/Last used temperature memory		•
Preheat bar (25%, 50%, 75%, 100%)		•
Automatic Fast Preheat		•
Child Door Lock		•
Commands Lock		•
Sabbath mode		•
12/24 hour clock format		•
°C/°F		•
Oven Door(s)		
Oven Glass Window		Large See Through Glass

FULGOR

MILANO

Door Cooling System	4 Pane Heat Resistant Glass
Door Hinges	Heavy Duty Steady Tilt
Handle Style	Stainless Steel Tube d25mm, Plastic terminals
Oven Cavity	
Gross Capacity (cuft)	4.4
Usable Capacity (cuft)	4.1
Cavity Enamel Colour	Black
Rack Positions	6
Oven Lights	3x20W Halogen
Broil Upper Heating Element	3500 W (240V)
Upper Auxiliary Element Wattage	1032W (240V)
Concealed Bake Lower Heating Element	3000 W (240V)
Convection Element Wattage	2x1300 W (240V)
Oven Accessories	
Chromed racks	2
Enameled Grill set (basin + anti splash)	1
Telescopic chromed rack	1
Meat probe	1
Dimensions	
Overall dim - width	29 11/16" (754mm)
Overall dim - height	27-7/8" (707mm)
Overall dim - depth	24" (610mm)
Cutout - width	28 7/16" (722mm)
Cutout - height (min)	27-1/4" (692mm)
Cutout - depth (min)	23-1/4" (590mm)
Power / Ratings (208/240 V, 60 Hz)	
KW/Amps rating at 240V, 60Hz	3.84kW - 16.9A
KW/Amps rating at 208V, 60Hz	3.54kW - 17.5A
Cable + Conduit	•
INSTRUCTIONS FOR USE	
Use & Care Manual	EN, SP, FR
Installation Manual	EN, SP, FR

FULGOR MILANO

30" Wall Double Oven 600 PROFESSIONAL SERIES

Weight & Dimensions

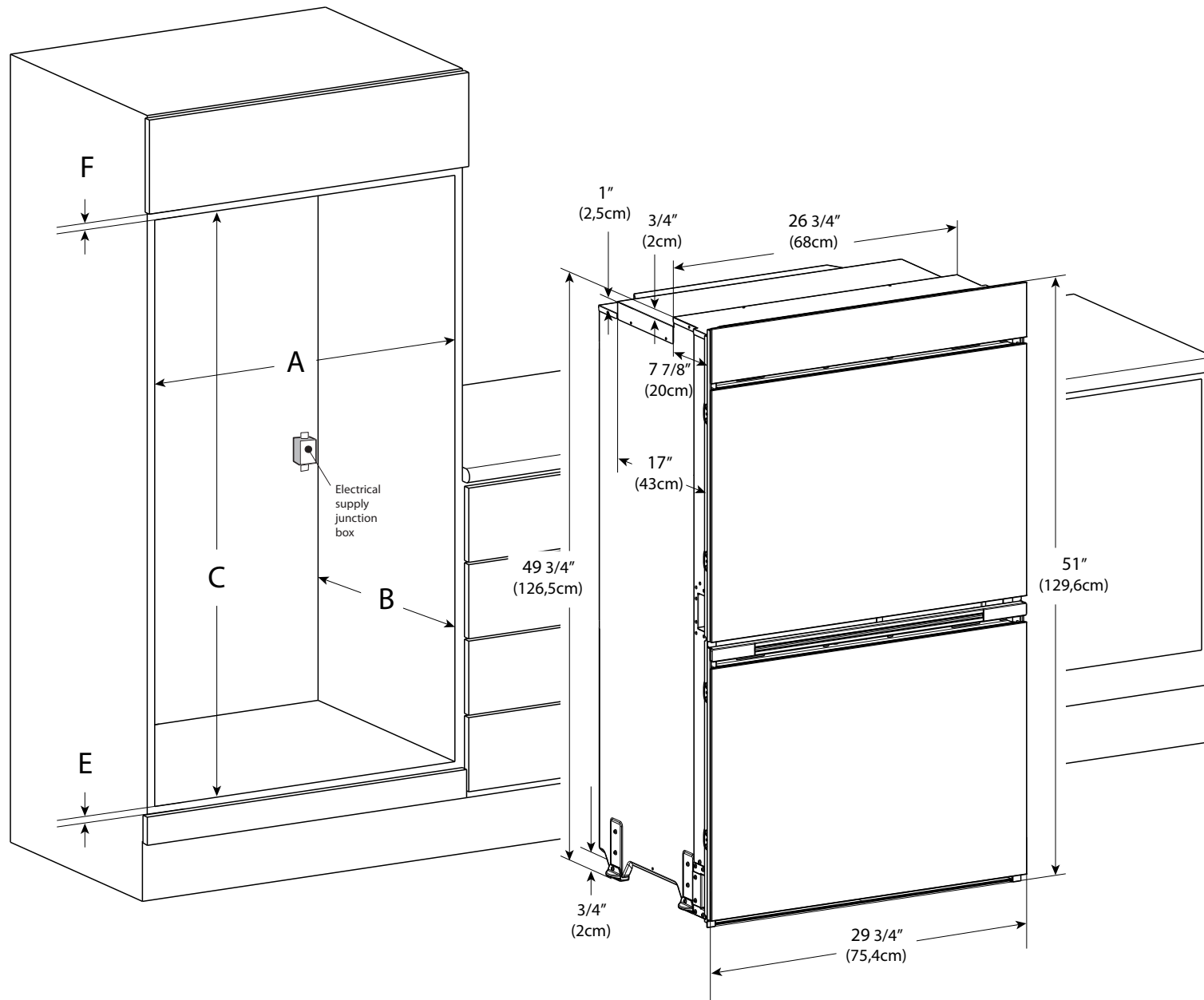

Ltr.	CUTOUT DIMENSION	inch	cm
A	Cutout Width	28 7/16"	72,2cm
B	Cutout Depth	24"	61cm
C	Cutout Height	50"	127cm
D	Floor Bottom of Cutout	NA	NA
E	Minimum Spacing	1/2"	1,3cm
F	Minimum Spacing	1 1/4"	3,2cm

PACKAGING		lb / inch	Kg / mm
GROSS WEIGHT		337 lb	153 Kg
DIMENSION	W	33"1/2	850
	D	31"1/8	790
	H	54"1/2	1385

