



Gas Range

User Manual

IMPORTANT

Installer should leave these instructions with appliance.

Consumer should read these instructions before using the appliance and should retain them for future reference.



SLGR30532SS

EN

285.6002.47/R.AB/15.12.2021/3-1

7732187944

IMPORTANT SAFETY INSTRUCTIONS

READ AND SAVE THESE INSTRUCTIONS



WARNING: If the information in this manual is not followed exactly, a fire or explosion may result causing property damage, personal injury or death.

— Do not store or use gasoline or other flammable vapors and liquids in the vicinity of this or any other appliance.

— **WHAT TO DO IF YOU SMELL GAS**

- Do not try to light any appliance.
- Do not touch any electrical switch.
- Do not use any phone in your building.
- Immediately call your gas supplier from a neighbor's phone. Follow the gas supplier's instructions.
- If you cannot reach your gas supplier, call the fire department.

— Installation and service must be performed by a qualified installer, service agency or the gas supplier.

This product was manufactured using the latest technology in environmentally friendly conditions.

TO PREVENT TIPPING: If the information in this manual is not followed exactly, a fire or explosion may result causing property damage, personal injury or death.



WARNING:

- ALL RANGES CAN TIP
- INJURY TO PERSONS COULD RESULT
- INSTALL ANTI-TIP DEVICES PACKED WITH RANGE
- SEE INSTALLATION INSTRUCTIONS



WARNING:

- **DO NOT OPERATE THE RANGE WITHOUT ANTI-TIP DEVICE IN PLACE AND ENGAGED**

"After installation cautiously grip the rear of the range to ensure the anti-tip bracket is engaging the rear foot of range."

Check for proper installation and use of the anti-tip bracket. Carefully tip the range forward pulling from the back to ensure that the anti-tip bracket engages the range leg and prevents tip-over. Range should not move more than 1" (25 mm).



IMPORTANT:

This appliance is intended for normal household use only. It is not approved for outdoor or other non-household uses (including sea or air-going vessels). See the Statement of Limited Warranty. If you have any questions, contact the manufacturer.

Do not repair or replace any part of the appliance unless specifically recommended in this manual. Refer all servicing to a factory authorized service center.

Explanation of symbols

Throughout this User Manual the following symbols are used:

 Important information or useful hints about usage.

 Warning for hazardous situations with regard to life and property.

 Warning for electric shock.

 Warning for risk of fire.

 Warning for hot surfaces.

DANGER indicates a hazardous situation which, if not avoided, will result in death or serious injury.

WARNING indicates a hazardous situation which, if not avoided, could result in death or serious injury.

CAUTION indicates a hazardous situation which, if not avoided, could result in minor or moderate injury.

NOTICE is used to address practices not related to physical injury.

Dear Customer,

Your product has been manufactured in modern facilities and has passed strict quality control procedures.

To obtain the best performance, we request that you read through this user manual carefully, especially the safety instructions, before using your product and that you keep it for future reference. If this product is given to another consumer, please give them this manual for their reference.



IMPORTANT:

Save these instructions for the local electrical inspectors use.



IMPORTANT:

This product can only be used in a room which incorporates a properly adjusted and functioning Carbon Monoxide sensor. Make sure the Carbon Monoxide sensor works properly and is maintained done frequently. Carbon Monoxide sensor should be installed maximum 6.5 feet away from the product.

The instructions will help you to operate the appliance properly and safely.

- Upon delivery, please check that the appliance is not damaged. If you note any transport damage, please contact the shipping company or company where you purchased the appliance immediately and do not connect and operate the appliance!
- When you pass on the appliance to another person, please provide all documents including original sales receipt which should show the date of purchasing. Warranty is not valid if the product is sold second hand.
- If you should decide not to use this appliance any longer (or decide to substitute an older model), before disposing of it, it is recommended that it be made inoperative in an appropriate manner in accordance with health and environmental protection regulations, ensuring in particular that all potentially hazardous parts be made harmless, especially in relation to children who could play with old appliances. Remove the door and the warming drawer before disposal to prevent entrapment.

TABLE OF CONTENTS

1 Safety Instructions 7

Basic safety instructions	7
Safety for children	10
Safety when working with electricity	10
Safety when working with gas	11
Intended use	12
Disposal	13
Packaging material	13
Future transportation	13

2 Installation 14

Installation and connection	14
Connection to the main supply	22

3 Preparation 24

Tips for saving energy	24
Initial Operation	24
Settings Menu	24
Setting the clock	24
Initial Heating	36
Initial use	36
First cleaning of the appliance	36
Initial heating	36

4 How to use the hob 37

General information about cooking	37
Using the hobs	37

5 How to operate the oven 39

General information on baking, roasting and broiling	39
Cooking times table	40

6 Maintenance and care 43

General information	43
Cleaning the burner/plate	43
Cleaning the control panel	43
Cleaning the oven	43
Removing the oven door	44
Replacing the oven lamp	44

7 General information 46

Overview	46
Technical specifications	47
Package contents	48
Injector table	50

8 Troubleshooting 52

9 Removing the Package 53

10 BEKO US RESIDENTIAL PRODUCT WARRANTY 55

1 Safety Instructions

Basic safety instructions

- This appliance is not intended for use by persons (including children) with reduced physical, sensory or mental capabilities, or lack of experience and knowledge, unless they have been given supervision or instruction concerning use of appliance by a person responsible for their safety.
- Children should be supervised to ensure that they do not play with the appliance.
- Never use when judgment or coordination is impaired by the use of alcohol and/or drugs.
- If the supply cord damaged, it must be replaced by a special cord or assembly available from the manufacturer or its service agent or similiary qualified persons.
- Do not operate the appliance if it is defective or shows any visible damage.
- Do not carry out any repairs or modifications on the appliance. However, you may remedy some malfunctions; see Troubleshooting.
- Only authorized replacement parts may be used in performing service on the range. Replacement parts are available from factory authorized parts distributors. Contact the nearest parts distributor in your area.
- Never modify or alter the construction of the range including by removing leveling legs, panels, wire covers, anti-tip brackets, or screws, or any other part of the appliance.
- Be careful when using alcoholic drinks in your dishes. Alcohol evaporates in high temperatures and may cause fire since it will catch fire when it gets in contact with hot surfaces.
- Your body accidentally can turn the knobs, please make sure that your body do not touch to knobs not for use.
- **WARNING:** Food Poisoning Hazard: Do not let food sit in oven for more than 1 hour before or after cooking. Doing so can result in food poisoning or sickness.
- **WARNING:** To avoid permanent damage to the oven bottom finish do not line the oven bottom with any type of foil or liner.
- **WARNING:** Never cover the top of burner grates with any kind of cover. Use only cooking utensils with recommended diameters. Make sure ventilation and oven

fume outlets shown below are not closed. Otherwise fire hazard and carbon monoxide poisoning can occur.

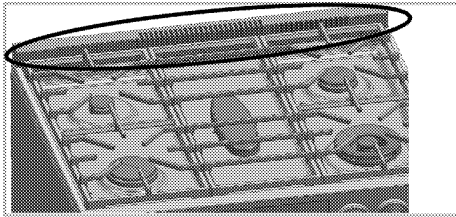

Do not heat closed food containers and glass jars. Pressure that may build-up in the jar can cause it to burst.

WARNING: (If your product has no illuminated knobs) : Do not remove knobs. Service authorized person should do it. There is a steel spring and steel ring inside the knob. Do not remove them. Otherwise, can be dangerous for the health issue and functionality.

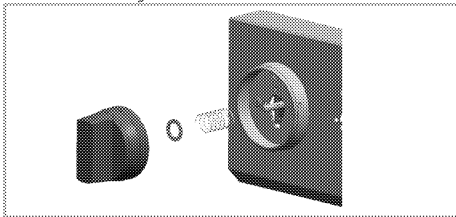

WARNING: Make sure that top burner grates are always centered on top of burners, as seen in the figure below. Misplacing of top burner grates may cause carbon monoxide poisoning and death. Always control top burner grates position before use.

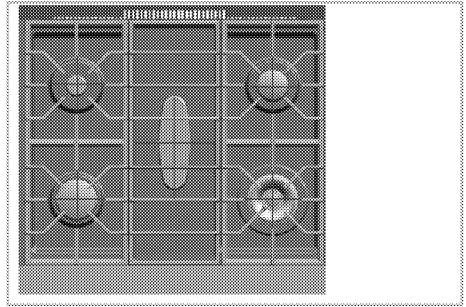

- Keep appliance area clear and free from combustible materials, gasoline, and other flammable vapors.
- Ensure that no flammable materials are adjacent to the appliance as the sides become hot during use.
- **Fire risk!** Do not store flammable material in the oven and/or in the warming drawer.
- **Do not use water on grease fires.** Smother fire or flame or use dry chemical or foam type extinguisher.
- Do not leave empty pots or pans on plates that are switched on. They might get damaged.
- Since it may be hot, do not leave plastic or aluminum dishes on the surface of appliance. These kind of dishes should not be used to keep food either.
- Do not use aluminium foil to line surface unit drip bowls or oven bottoms or oven bottoms, except as suggested in the manual. Im-

proper installation of these liners may result in a risk of electric shock, and/or fire.

- The manufacturer declines all liability for injury to persons or damage to property caused by incorrect or improper use of the appliance.
- Always use only dry potholders or heat-resistant gloves when inserting or removing the dishes into/from your oven. Do not let potholder touch hot heating elements. Do not use a towel or other bulky cloth.
-  **WARNING:** NEVER cover any slots, holes or passages in the oven bottom or cover an entire rack with materials such as aluminum foil. Doing so blocks air flow through the oven and may cause carbon monoxide poisoning. Aluminum foil linings may also trap heat, causing a fire hazard.
- Do not use the oven with front door glass removed or broken.
- Rear surface of the oven gets hot when it is in use. Electric connection should not touch the rear surface, otherwise the main cable may get damaged. Do not trap the main cable between the hot oven door and frame. Do not route the main cable over the hot cooking section. Otherwise, cable insulation may melt and cause fire as a result of short circuit.
- Never wear loose-fitting or hanging garments while using the appliance. Be careful when reaching for items stored in cabinets over the oven. Flammable material could be ignited if brought in contact with hot surfaces or heating elements and may cause severe burns.
- Flame in the oven can be smothered completely by closing the oven door and turning the oven off or by using a multi-purpose dry chemical or foam-type fire extinguisher.
- Place the oven rack in the desired position while the oven is cool. If racks must be handled when hot, do not let pot holder contact the heating elements.
- Do not use the oven to dry newspapers. If overheated, they can catch on fire.
- After broiling, always take any broiler pan out of the oven and clean it. Leftover grease in a broiler pan can catch fire next time you use the pan.
- Check that all controls on the appliance are switched off after use.
- **IMPORTANT:** Call the authorized service for installation of the ap-



pliance to be used. After this procedure, guarantee period will be started.

Safety for children

- **WARNING:** Stepping, leaning or sitting on the door or drawers of this range can result in serious injuries and also cause damage to the range. Do not allow children to climb or play around the range. The weight of a child on an open door may cause the range to tip, resulting in serious burns or other injury.
- Accessible parts may be hot when the broil is in use. Young children should be kept away.
- Surface units may be hot even though they are dark in color. Areas near surface units may become hot enough to cause burns. During and after use, do not touch or let clothing or other flammable materials contact surface units until they have had sufficient time to cool. Among these areas are (identification of areas) for example, the cook-top and surfaces facing the cook-top.
- **WARNING:** Do not store items of interest to children in the cabinets above the range or on back guard of a range. Children climbing on the range to reach items could be seriously injured.

- The packaging materials will be dangerous for children. Keep the packaging materials away from children. Please dispose of all parts of the packaging according to environmental standards.

Safety when working with electricity

-  **WARNING:** Before installing, turn power OFF at the service panel. Lock service panel to prevent power from being turned ON accidentally.
-  **WARNING:** Personal injury or death from electrical shock may occur if the range is not installed by a qualified installer or electrician.
- Any additions, changes or conversions required in order for this appliance to satisfactorily meet the application needs must be made by a qualified technician.
- In case of any damage, switch off the appliance and disconnect it from the main supply by removing the fuse or switching off the circuit breaker.
- Ensure that the fuse rating is correct.
- Do not operate the appliance barefooted.
- Never touch the appliance with wet hands or feet.

Safety when working with gas

- **WARNING:** To reduce the risk of personal injury in the event of a grease fire, observe the following:
- Smother flames with a close-fitting lid, cookie sheet, or metal tray, then turn off the burner. Exercise caution to prevent burns. If the flames do not go out immediately, evacuate and call the fire department.
- Never pick up a flaming pan—You may be burned.
- Do not use water, including wet rags
- Or towels—a violent steam explosion will result.
- Make certain that gas shutoff valve and all burner controls are in the OFF position before beginning.

Use an extinguisher only if:

- 1) You know you have a CLASS ABC extinguisher and you already know how to operate it.
 - 2) The fire is small and contained in the area where it started.
 - 3) The fire department is being called.
 - 4) The fire does not obstruct your escape route.
- Any works on gas equipment and systems may only be carried out by authorized qualified persons.

- "Prior to the installation, ensure that the local distribution conditions (nature of the gas and gas pressure) and the adjustment of the appliance are compatible."
- "This appliance is not connected to a combustion products evacuation device. It shall be installed and connected in accordance with current installation regulations. Particular attention shall be given to the relevant requirements regarding ventilation;" See Before installation.
- **CAUTION:** "The use of gas cooking appliance results in the production of heat and moisture in the room in which it is installed. Ensure that the kitchen is well ventilated: keep natural ventilation holes open or install a mechanical ventilation device (mechanical extractor hood). Prolonged intensive use of the appliance may call for additional ventilation, for example increasing the level of the mechanical ventilation where present."
- Gas appliances and systems must be regularly checked for proper functioning. Please arrange for annual maintenance.
- Clean the gas burners regularly. The flames should be blue and burn evenly.

- Good combustion is required in gas appliances. In case of incomplete combustion, carbon monoxide (CO) might develop. Carbon monoxide is a colorless, odorless and very toxic gas, which has a lethal effect even in very small doses.
- Request information about gas emergency telephone numbers and safety measures in case of gas smell from your local gas provider.
- The appliance and its individual shut-off valve must be disconnected from the gas supply piping system during any pressure testing of that system at test pressures in excess of 1/2 psi (3.5 kPa).
- The appliance must be isolated from the gas supply piping system by closing its individual manual shutoff valve during any pressure testing of the gas supply piping system at test pressures equal to or less than 1/2 psi (3.5 kPa).
- Hob burners will not automatically re-ignite in the event of power failure and unignited gas will still be expelled from the burners. Switch off burners immediately whenever a power failure occurs.

Intended use

- **WARNING:** Use this appliance only for its intended use as described in this manual. NEVER use this appliance as a space heater to heat or warm a room. Doing so may result in carbon monoxide poisoning and overheating the appliance. Never use the appliance for storage.
- This appliance should not be used for warming the plates under the broil, hanging towels and dish cloths on the handles, for drying and the space heating purposes.
- All openings in the wall behind the appliance and in the floor under the appliance shall be sealed.
- This appliance is not intended to use at mobile homes, recreational vehicles.
- Do not obstruct the flow of ventilation air.
- The manufacturer shall not be held liable for any damage caused by improper use or handling errors.
- The appliance can be used for defrosting, baking, roasting and broiling food.

Disposal

Packaging material



DANGER:

Risk of suffocation by the packaging materials!

Packing elements (i.e. plastic bags, polystyrene foam, nails, packing straps, etc.) should not be left around within easy reach of children, as these may cause serious injuries.

The packaging material and transport locks are made from materials that are not harmful to the environment. Please dispose of all parts of the packaging according to environmental standards. This is beneficial to the environment.



CAUTION:

If product will be given to someone for personal use or given to someone for second hand use, User manual, product labels, other related documents, mounting parts etc. should be given with product.

Future transportation

Do not carry out cleaning or maintenance operations on the appliance without having pre-

viously disconnected it from the electric power supply.



NOTICE:

Do not place other items on the top of the appliance. The appliance must be transported upright.

Store the appliance's original box and transport the appliance in its original carton. Follow the guidance marks that are printed on the carton.



IMPORTANT:

Verify the general appearance of your equipment by identifying possible damage during the transportation.

To prevent the wire shelf and tray inside the oven from damaging the oven door, place a strip of cardboard onto the inside of the oven door that lines up with the position of the trays. Tape the oven door to the side walls.

If you do not have the original carton

Pack the appliance in bubble wrap or thick cardboard and tape it securely in order to prevent damage during transportation.

2 Installation

To ensure that critical air gaps are maintained under the appliance, we recommend that this appliance is mounted on a solid base and that the feet do not sink into any carpet or soft flooring.

The kitchen floor must be able to carry the weight of the appliance plus the additional weight of cookware and bake ware and food.

- If an appliance hood is to be fitted, refer to the manufacturer's instructions regarding fixing height.
- The appliance corresponds to device class 1, i.e. it may be placed with the rear and one side to kitchen walls, kitchen furniture or equipment of any size. The kitchen furniture or equipment on the other side may only be of the same size or smaller.
- Any kitchen furniture next to the appliance must be heat-resistant (212 °F min.).

Room ventilation

The air for combustion is taken from the room air and the exhaust gases are emitted directly into the room.

Good room ventilation is essential for safe operation of your appliance. If there is no window or door available for room ventilation, an extra ventilation must be installed.

Do not install this appliance in a room below ground level unless it is open to ground level on at least one side. Failure to install correctly is dangerous and could result in prosecution.

Prolonged intensive use of the appliance may call for additional ventilation, for example the opening of a window, or the use of permanent fixed mechanical ventilation system, for example, an extractor fan or cooker hood that ventilates to the outside.

Be sure your appliance is properly installed and grounded by a qualified technician in accordance with the National Fuel Gas Code ANSI Z223.- latest edition, or in Canada, CAN/CGA B149.1, and CAN/CGA B149.2, and National Electrical Code ANSI/NFPA No.70 - latest edition, or in Canada CSA Standard C22.1, Canadian Electrical Code, Part 1 and local code requirements.

Installation and connection



IMPORTANT:

Do not install the appliance next to refrigerators or freezers. The heat emitted by the appliance will lead to an increased energy consumption of cooling appliances.

- For installation the appliance must be connected in accordance with all local electrical and/or gas regulations.



CAUTION:

Unit is heavy (approximately 150 kg) and requires at least two persons or proper equipment to move. Do not move more than 3 meters without any instrument. Otherwise, you can cause injury.

- Hidden surfaces may have sharp edges. Use caution when reaching behind or under appliance.
- Do not use the oven or warming drawer (if equipped) for storage.

Room size	Ventilation opening
smaller than 177ft ³	min. 15.5 in ²
177ft ³ to 353ft ³	min. 7.75 in ²
greater than 353ft ³	not required
in the cellar or basement	min. 10.1 in ²

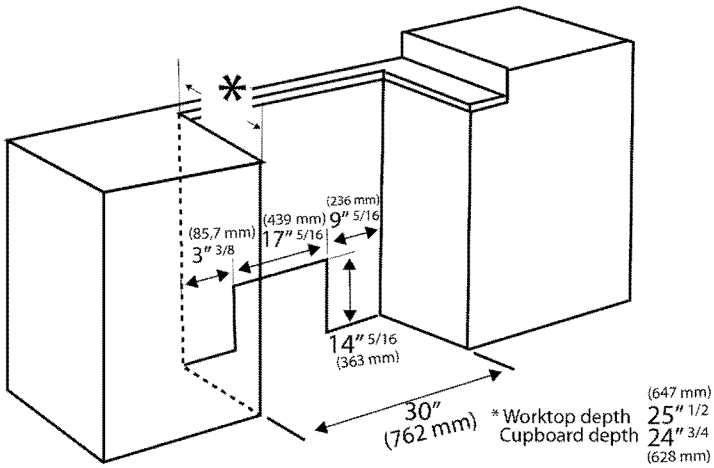
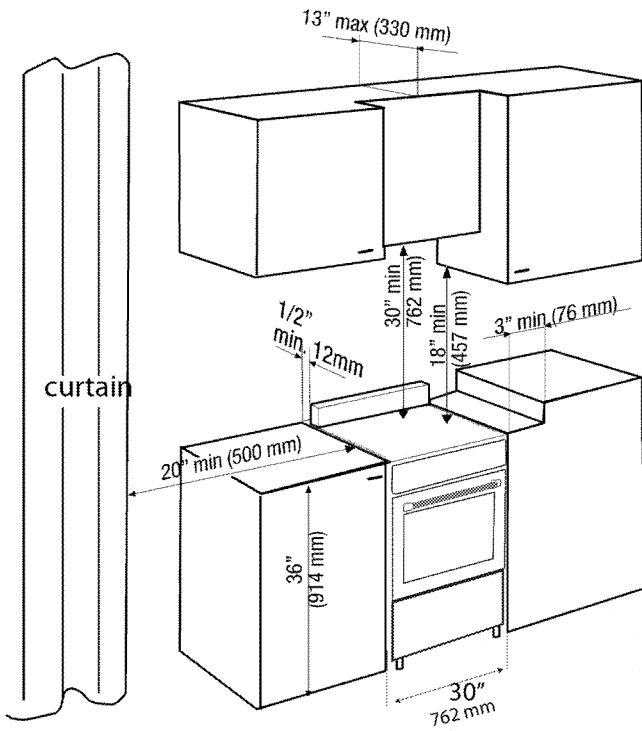



NOTICE: Material damage!

Do not place other items on the top of the appliance. The appliance must be transported upright. The door and/or handle must not be used for lifting or moving the appliance. Take care not to touch the oven heating element also located at the top of the oven cavity, just behind the ridged area. It is recommended to wear gloves and long sleeves to protect hands and forearms from abrasion and potential scratches during the lifting process. It is also recommended to take off watches and jewelry and to wear work shoes during installation for foot protection. Remove the oven door for easier handling and installation.

- The appliance must be placed directly on the floor. It must not be placed onto a base or a pedestal.

How to move the appliance

Movement of your appliance is most easily achieved by lifting the front as indicated in the drawing. Open the oven door sufficiently to allow a comfortable and safe grip on the underside of the oven roof avoid causing any damage to the grill element or any internal parts of the oven. Do not move by pulling on the door handle or knobs. Move the appliance a bit at a time until placed in the position required.

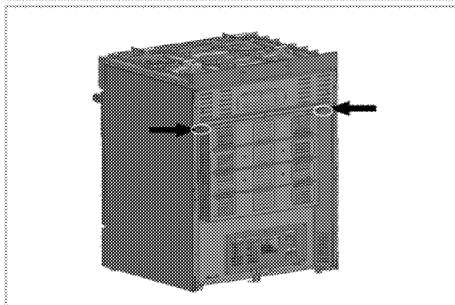
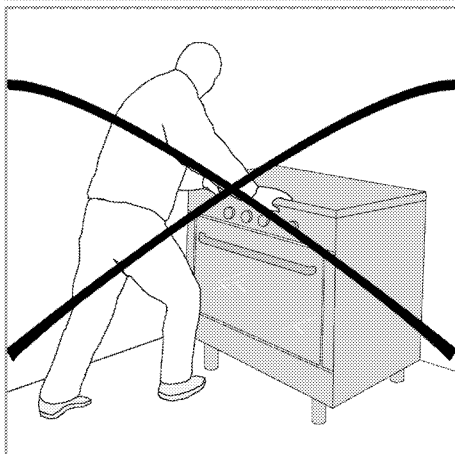
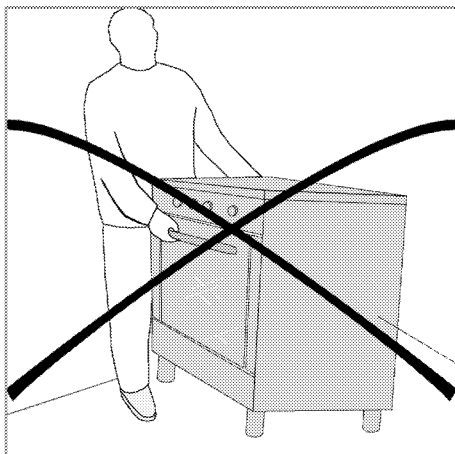
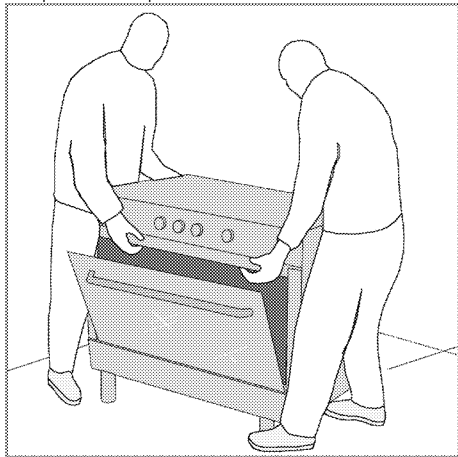

Clearances & Dimensions

Dimensions that are shown in figure must be used. Given dimensions provide minimum clearance. There needs to be a 30-inch minimum clearance between the top of the cooking surface and the bottom of unprotected wood or metal cabinets or a 24-inch minimum when bottom of wood or metal cabinets are protected by not less than a 1/4-inch flame retardant millboard covered with not less than no. 29 msg sheet-steel, 0.015-inch stainless steel, 0.024-inch aluminum or 0.020-inch copper.

To eliminate the risk of burns or fire by reaching over heated surface units, cabinet storage space located above the surface units should be avoided. If cabinet storage is to be provided, the risk can be reduced by installing a range hood that projects horizontally a minimum of 5 inches beyond the bottom of the cabinets.

This appliance is not intended for use in mobile homes, recreational vehicles.

Important notes to the installer

Read manual before installing the cooker.

Observe all governing codes and ordinances.

Be sure to leave these instructions with the consumer.

Be sure your range is installed and grounded properly by a qualified installer or service technician.



IMPORTANT:

Before installing the range in an area covered with linoleum or any other synthetic floor covering, make sure the floor covering can withstand heat at least 90°F (32.2°C) above room temperature without shrinking, warping or discoloring.

Do not install the range over carpeting unless you place an insulating pad or sheet of 1/4inch (0.64cm) thick plywood between the unit and carpeting.



WARNING:

All ranges can tip and injury to persons could result.

- Anti-Tipstabilitydevices are fixed on wooden plate. During the removing packaging materials, the Anti-Tipstabilitydevices should be unscrewed from wooden plate and should not be thrown away.
- A risk of tip-over may exist if the appliance is not installed in accordance with these instructions.
- If the range is pulled away from the wall for cleaning, service or any other reason, ensure that the Anti-Tip Device is properly re-engaged when the range is pushed back against the wall. In the event of abnormal usage (such as a person standing, sitting or leaning on an open door), failure to take this precaution can result in tipping of the range. Personal injury might result from spilled hot liquids or from the range itself.

Anti-Tip stability device installation instructions

1. Fix the bracket 1 to the floor with 4 screws (5) in accordance with the dimensions and direction indicated in Picture 1.
2. Measure dimension A of the product indicated in Picture 2 according the height of counter. Decide the hole on bracket 1 to which the bracket 2 will be secured. Complete the installation by tightening parts 3 and 4.
3. Position the appliance on its place after completing the installation.
4. Check whether the appliance is locked with bracket by gently lifting it up from rear side to front side.

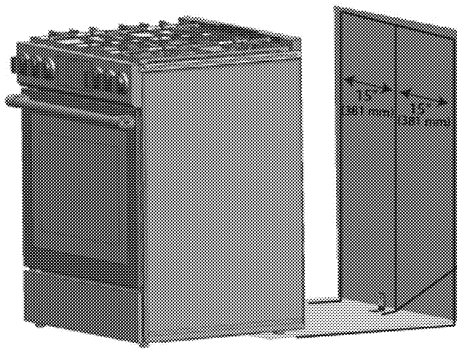

PICTURE - 1

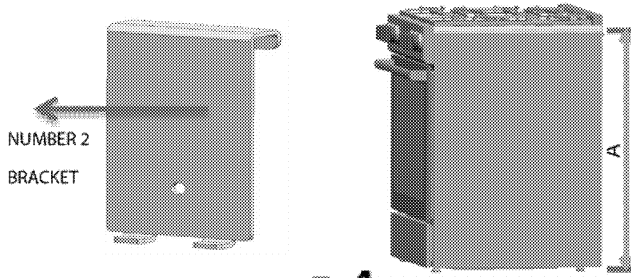
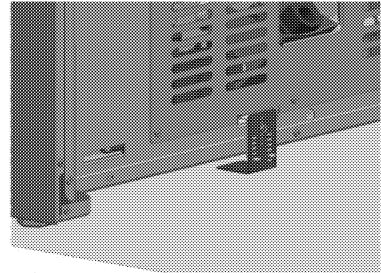
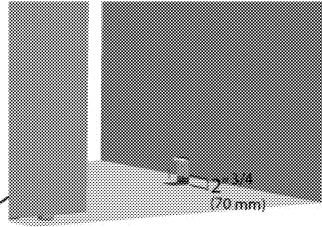

PICTURE - 2

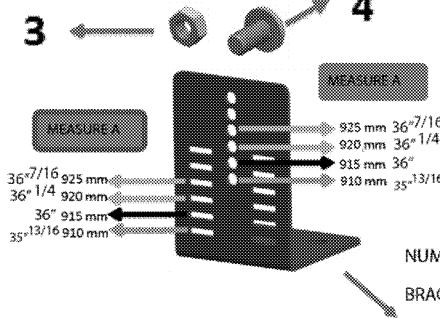

SCREWS 4 PIECES

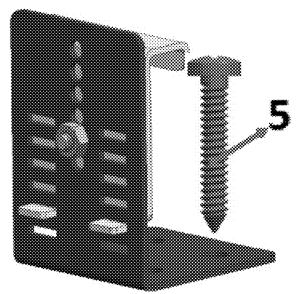

**WARNING:Tip Over Hazard**

A child or adult can tip the range and be killed. Connect anti-tip bracket to anti-tip hole at the back of the range. Reconnect the anti-tip bracket, if the range is moved. Failure to follow these instructions can result in death or serious burns to children and adults.

**WARNING:Electrical shock hazard!**

- Use extreme caution when drilling holes into the wall or floor. There may be concealed electrical wires located behind the wall or under the floor.
- Identify the electrical circuits that could be affected by the installation of the Anti Tip Device, then turn off power to these circuits.

Failure to follow these instructions may result in electrical shock or other personal injury.

Connection to the gas supply

This appliance has been tested in accordance with the following standards:

- Household Cooking Gas Appliances [ANSI Z21.1:2018]
- Household Cooking Gas Appliances [CSA 1.1:2018]
- Gas-fired appliances for use at high altitudes [CSA 2.17-2017]
- It is the responsibility of the owner and the installer to determine if additional requirements, such as local codes and/or standards, apply to specific installations. In the absence of local codes, the installation must conform with the National Fuel Code, ANSI Z223.1/NFPA54.

For Massachusetts Installations:

1. Installation must be performed by a qualified or licensed contractor, plumber or gas fitter qualified or licensed by the state , province or region where this appliance is being installed.
2. Shut-off valve must be a "T" handle gas cock.
3. Flexible gas connector must not be longer than 36 inches.

Installer -show the owner where the gas shut-off valve is located.

High Altitude Installation note:

This cooker is ETL certified for safe operation up to an altitude of 2000 ft without any modifica-

tions. For altitudes between 2000-4500, please contact with Service and request conversion with high altitude injector kit. This product is not intended to be used for altitudes higher than 4500 ft.

THE CONVERSION SHALL BE CARRIED OUT BY A MANUFACTURER'S AUTHORIZED REPRESENTATIVE, IN ACCORDANCE WITH THE REQUIREMENTS OF THE MANUFACTURER, PROVINCIAL, OR TERRITORIAL AUTHORITIES HAVING JURISDICTION AND IN ACCORDANCE WITH THE REQUIREMENTS OF THE CSA B149.1 OR CSA B149.2 INSTALLATION CODES

Connect to the gas supply**WARNING:**

This product can be converted to LP Gas. Gas conversion must always be performed by Authorized Service Agents.

The gas connection is located below the back panel of the range. It is accessible back of the range.

Shut off main gas supply valve before disconnecting the old range and leave it off until the new hook-up has been completed.

The cooker can be installed using rigid pipe or a CSA, cCSAus, UL International-certified flexible metal appliance connector. If using a flexible connector, always use a new connector.

Apply pipe joint compound or tape appropriate for use with Natural gas around all male pipe threads to prevent leaks.

If not already present, install gas shut off valve in an easily accessible location. Make sure all users know where and how to shut off the gas supply to the range.

Gas supply pressure for checking the regulator setting is 6" WC.

**NOTICE:**

The installer should inform the consumer of the location of the gas shut-off valve. Flexible Connector Method

1. Install male 1/2" flare adaptor at the 1/2" NPT internal thread of the range inlet. Use a backup wrench on the elbow fitting to avoid damage.

2. Install male 1/2" or 3/4" flare union adaptor on the NPT internal thread, of the manual shut-off valve.
3. Connect flexible metal appliance connector.
4. Make sure circuit breaker is off and then plug range cord in to electrical outlet
5. Push range back into position insuring that range leg slides under the anti-tip bracket. The range will sit 3/4" away from the wall when properly installed.



NOTICE:

Be careful not to crimp flexible connector!

6. Carefully tip range forward to insure that anti-tip bracket engages and prevents tip-over.

Rigid Pipe Method The configuration of the rigid pipe connection will vary depending on the location of the gas pipe stub. Refer to Figure below for details.

1. Make sure circuit breaker is off and then plug range cord in to electrical outlet
2. Push range back into position insuring that range leg slides under the anti-tip bracket. The range will sit 3/4" away from the wall when properly installed.
3. Carefully tip range forward to insure that anti-tip bracket engages and prevents tip- over.
4. Connect pipe to range at union. Access the connection through the access panel behind the warming drawer.

Proceed to "Test for Gas Leaks"

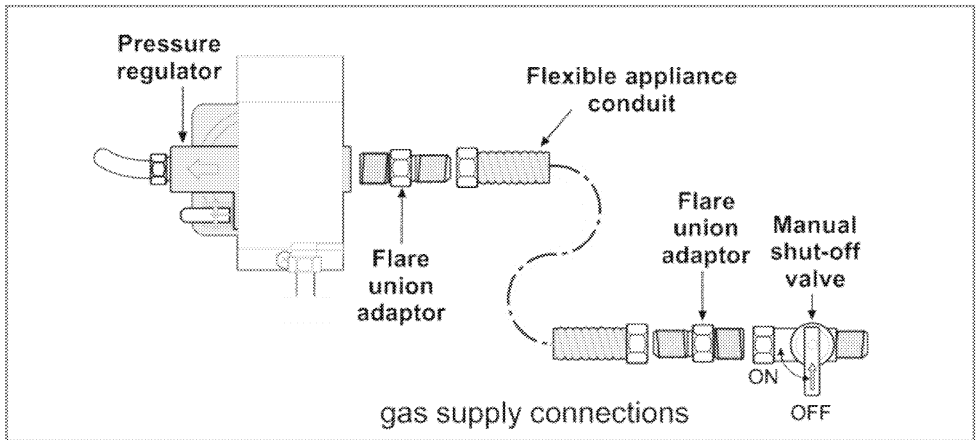



Test for Gas Leaks

Leak testing shall be conducted by the installer according to the instructions given in this section.

Turn on Gas. Apply a non-corrosive leak detection fluid to all joints and fittings in the gas connection between the shut-off valve and the range. Include gas fittings and joints in the range if connections may have been disturbed during installation. **Bubbles appearing around fittings and connections indicate a leak.**

If a leak appears, turn off supply line gas shut-off valve and tighten connections. Re-test for leaks by turning on the supply line gas shut-off valve. When leak check is complete (no bubbles appear), test is complete. Wipe off all detection fluid residue.

	WARNING: Never check for leaks with a flame. Do not continue to the next step until all leaks are eliminated.
	WARNING: Before you plug in an electrical cord, be sure all controls are in the OFF position.

Test burner function

1. Turn on Power at Breaker

Verify that wiring in house is correctly installed. If not call Service.

2. Test Rangetop Burners

Test Burner Ignition. Select a range top burner knob. Push down and turn to the flame symbol. The igniter/spark module will produce a clicking sound. Once the air has been purged from the supply lines, the burner should light within four (4) seconds.

Test Flame: High Setting. Turn burner on to HI. See for appropriate flame characteristics. If any of the burners continue to burn mostly or completely yellow, call Service.

Test Flame: Low Setting. Turn burner on to L.O. Verify that the flame completely surrounds the burner. There should be a flame at each burner port and there should be no air gap between the flame and the burner. If any of the burners do not carry over, call Service.

Test the ignition and flame of each range top burner as described above.

When flame is properly adjusted

There should be a flame at each range top burner port.

There should be no air gap between the flame and the burner port.

3. Test Oven Burners

Open the oven door. Remove the two front thumb screws of oven bottom cover, slide cover forward and out. Remove the reflector cover forward and out.

Test Bake Burner Ignition. Set the oven to bake at 350° F. After 30-75 seconds, the burner will ignite. The burner will stay lit until the 350° F is reached and then shut off. From this point forward, the burner will cycle on and off to maintain the temperature.

Test Bake Burner Flame. While the burner is lit, inspect the flame. See below flame figures for proper flame characteristics. If the flame burns completely or mostly yellow, adjust the bake burner air shutter. See below flame figures (next page) for details.

Test Broil Burner Ignition. Set cooking mode to Hi Broil. The burner will ignite after 30-75 seconds.

Test Broil Burner Flame. While the burner is lit, inspect the flame. See below flame figures for proper flame characteristics. If the flame burns completely or mostly yellow, adjust the broil burner air shutter. See below flame figures for details.

Replace the reflector cover and oven bottom cover. Fix the cover with two rear thumb screws.

Flame Characteristics

Yellow Flames:

Further adjustment is required



Soft Blue Flames:

Normal for Natural Gas.

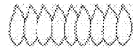

If the flame is completely or mostly yellow, verify that the regulator is set for the correct fuel. After adjustment, retest.

Some yellow streaking is normal during the initial start-up. Allow unit to operate 4-5 minutes and re-evaluate before making adjustments.

Call Service if;

1. Any of the burners do not light.
2. The broil burner or bake burner flame goes out before reaches 350° F.
3. Any of the burners continue to burn yellow.



NOTICE:

If the temperature of the oven increases unintended, turn off the oven and call the authorized service agent or technician with license to have oven repaired.

The California Safe Drinking Water and Toxic Enforcement Act requires the Governor of California to publish a list of substances known to the State of California to cause cancer, birth defects, or other reproductive harm, and requires businesses to warn of potential exposure to such substances.



WARNING: This product can expose you to chemicals including Nickel (Metallic) which is known to the State of California to cause cancer. For more information go to www.P65Warnings.ca.gov
Note: Nickel is a component in all stainless steel and some other metal components.



IMPORTANT:

This product contains a chemical known to the State of California to cause cancer, birth defects, or other reproductive harm.

Connection to the main supply



IMPORTANT:

Electrical installation should comply with national and local codes.



IMPORTANT:

This appliance must be grounded!



WARNING

Avoid fire hazard or electrical shock. Do not use an adapter plug, an extension cord, or remove grounding prong from electrical power cord, have a qualified electrician install an outlet near the appliance. Failure to follow this warning can cause serious injury, fire or death.



WARNING

Risk of Electric Shock or Fire. Grounding through the neutral conductor is prohibited for new branchcircuit installations (1996 NEC), mobile homes, and recreational vehicles, or in an area where local codes prohibit grounding through the neutral conductor.

This appliance is equipped with a 3-prong grounding plug for your protection against shock hazard and should be plugged directly into a properly grounded receptacle. DO NOT cut or remove the grounding prong from this plug.

For personal safety, the range must be properly grounded. For maximum safety, the power cord must be plugged into an electrical outlet that is correctly polarized and properly grounded.

If a 2-prong wall receptacle is the only available outlet, it is the personal responsibility of the consumer to have it replaced with a properly grounded 3-prong wall receptacle installed by a qualified electrician.



WARNING

Do not ground to a gas pipe.

Our company shall not held responsible for any damage caused by using the appliance without grounded receptacle.

The wiring diagram covering the control circuit is located inside the lower panel, below the oven door panels.

The main supply data must correspond to the data specified on the rating plate of the appliance. The rating plate is either seen when the door is opened.

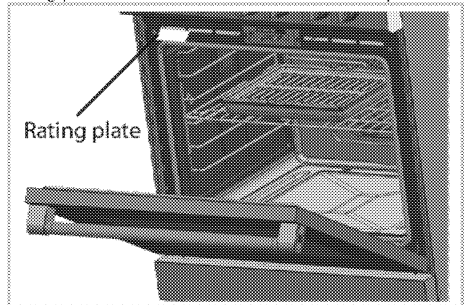

To minimize possible shock hazard, the cord must be plugged into a mating 3-prong ground-type outlet, grounded to conform with the National Electrical Code, ANSI/NFPA 70 latest edition, or Canadian Electrical

Code (CSA) and all local codes and ordinances. Refer to the illustration below.

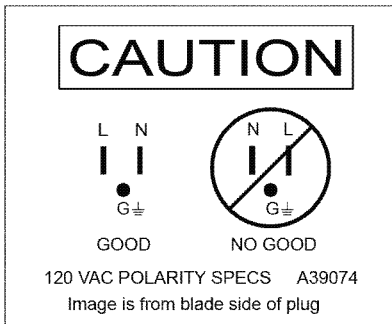
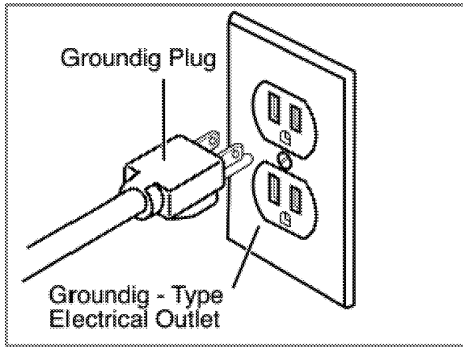

WARNING
Electrical Grounding Instructions

The appliance is equipped with a three-prong (grounding) plug for your protection against electrical shock hazard and should be plugged directly into a properly grounded three-prong receptacle.

Do not cut or remove the grounding prong from the plug.

WARNING

For gas fired 120 VAC units and any NEC compliant receptacle, proper ground and correct polarity is required.

Electric convection ovens are configured at the factory for operation from 208 VAC, single phase, or 208 VAC, three-phase electrical service is also an available configuration. Consult wiring diagram located at the end of this manual and on the back side of the appliance.

WARNING

Risk of electric shock, short circuit or fire by damage of the main power supply!
The main power supply lead must not be clamped, bent or trapped or come into contact with hot parts of the appliance.
If the main power supply is damaged, it must be replaced by a qualified electrician.

IMPORTANT:

The gas cooker requires a 110/120VAC electrical supply to operate the electronic ignition system. The 6' (1.8 m) power supply cord provided with the range is equipped with a 3-prong, grounded plug for protection against shock hazard. The service should have its own 15 amp circuit breaker.

IMPORTANT:

You must follow all National Electrical Code and gas regulations.
In addition, be aware of local codes and ordinances when installing your services.

IMPORTANT:

To prevent electrical shock, the grounding prong on the range cord should not be cut or removed under any circumstances. It must be plugged into a matching grounding type receptacle and connected to a correctly polarized 240-Volt circuit. If there is any doubt as to whether the wall receptacle is properly grounded, have it checked by a qualified electrician.

IMPORTANT:

Do not loosen the factory installed nut connections which secure the range wiring to terminal block. Electrical failure or loss of electrical connection may occur if these 2 nuts are loosened or removed..

- To align the appliance with the worktop, adjust the feet turning right or left hand as required.

3 Preparation

Tips for saving energy

The following information will help you to use your appliance in an ecological way, and to save energy:

- Use dark colored or enamel coated cookware in the oven since the heat transmission will be better.
- While cooking your dishes, perform a preheating operation if it is advised in the user manual or cooking instructions.
- Do not open the door of the oven frequently during cooking.
- Try to cook more than one dish in the oven at the same time whenever possible. You can cook by placing two cooking vessels onto the wire shelf.
- Cook more than one dish one after another. The oven will already be hot.
- Defrost frozen dishes before cooking them.
- Use pots/pans with cover for cooking. If there is no cover, energy consumption may increase 4 times.
- Select the burner which is suitable for the bottom size of the pot to be used. Always select the correct pot size for your dishes. Larger pots require more energy.,

Initial Operation

Before first usage of your appliance, don't forget to remove the sticker on the control panel.



IMPORTANT:

Smoke and smell may emit for a couple of hours during the initial operation. This is quite normal. Ensure that the room is well ventilated to remove the smoke and smell. Avoid directly inhaling the smoke and the smell that emits.

Setting the time



IMPORTANT:

Default setting for clock is 12:00 after initial powering.



IMPORTANT:

Active time setting automatically reset when power failure. Please set the clock again.

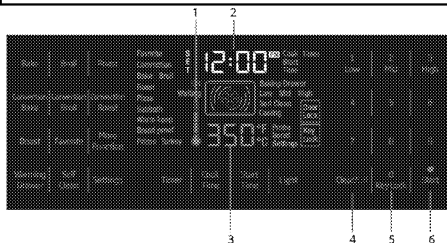

- 1- Symbol of internal temperature
- 2- Area of active clock
- 3- Area of set temperature
- 4- Clear/Off touchpad
- 5- KeyLock touchpad to disable all keys.
- 6- Start/Approve touchpad for cooking

Settings Menu

Setting the clock



- 1-Touch the "Settings" touchpad once.
- 2-Display of timer, "Time" and "Settings" touchpads flash.
- 3-Edit the clock with using numeric keypad.
- 4-When desired time entered, set the time by pressing "Start" or wait approximately 10 seconds.
- 5-After making 12 hours setting, you can perform AM-PM selection by using button number 8.

Settings the Time

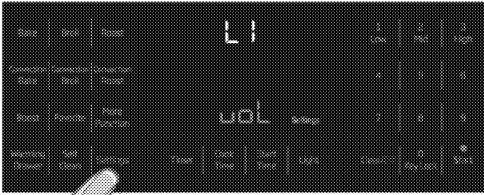

- 1- Touch the "Settings" touchpad twice.
- 2- "Settings" touchpad flashes and "voL" icon appears in the display.
- 3- Adjust tone with touching 1, 2 and 3 in the numeric keypad.
- 4- When desired tone entered, set the tone by touching "Start" or wait 10 seconds.

Setting 12 hr - 24 hr



- 1- Touch the "Settings" touchpad three times.
- 2- "Settings" touchpad flashes.
- 3- Adjust 12 hr or 24 hr with touching 1 and 2 in the numeric keypad.
- 4- Set the 12-hr or 24-hr by pressing "Start" or wait approximately 10 seconds.

Settings Temperature Unit

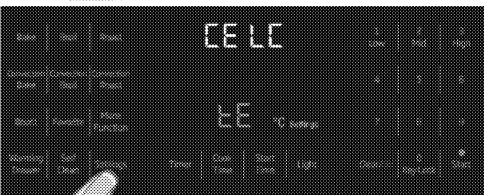

- 1- Touch the "Settings" touchpad four times.
- 2- "Settings" touchpad and icon of °F or °C flashing.

3- Adjust °F or °C with touching 1 and 2 in the numeric keypad.

- 4- When desired unit entered, set the temperature unit by touching "Start" or wait approximately 10 seconds.

Using Oven

Stand-by mode is active when oven has power.

The display shows only active time.

When stand-by mode is active;

- Bake
- Broil
- Roast
- Convection Broil
- Convection Bake
- Convection Roast
- More Function
- Self Clean
- Warming Drawer
- Settings
- Light
- Key lock
- Favorite
- Timer

touchpads are active.

Setting Temperature and Function Mode

Sample display for initial operation mode of oven functions.

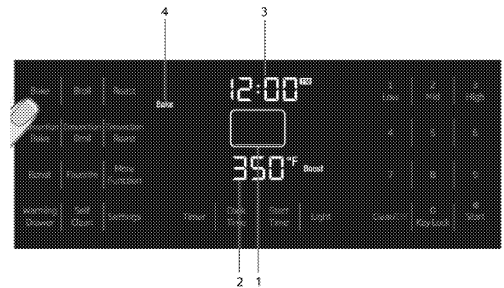

- 1- Functions icon
- 2- Area of set temperature
- 3- Area of active clock
- 4- Function mode name

Recommended temperature is shown in the area of set temperature and working heaters or components are shown in the functions icon.

"Temperature", "Cook Time", "Cook End Time" can be adjustable when functions are selected. Temperature should be adjustable when functions (except Broil, Convection Broil, Warm Keep and Warming Drawer) are firstly selected. Set temperature adjusts with numeric keypad. You can change set temperature after starting

Function Table

Function table indicates the functions that can be used in the oven and their respective maximum, minimum and initial display temperatures.

FUNCTION	RECOMENDED TEMPERATURE	LOW	MID	HIGH	MAX	MIN
F	F	F	F	F	F	F
BAKE	350				550	125
CON BAKE	350				550	125
BROIL	375	375	410	465		
CON BROIL	375	375	410	465		
ROAST	375				550	125
CON ROAST	350				550	125
PIZZA	425				550	125
SABBATH	350				450	125
WARM KEEP	150	150	170	200		
BREAD PROOF	100				125	100
PRIME TURKEY	325				550	125
SELF CLEAN		3 HOURS	4 HOURS	5 HOURS		

cook. If you want to change set temperature after starting cook, touch same function and change set temperature.

Broil, Convection Broil, Warm Keep and Warming Drawer functions' temperature can adjust with pressing 1-Low, 2-Mid and 3-High in the numeric keypad.

Bake

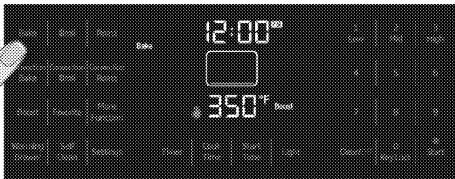

Only bottom heat is on. The bake mode can be used for a variety of food items, from cakes to casseroles.

Bake food on a single rack with the pans are positioned in the middle of the oven. Bake foods with 1" to 1" ½ space between pans and oven walls.

When using the Bake mode, preheat the oven for best results.

Baking time will vary with the size, shape and material of the pan used.

Convection Bake



Only bottom heat is on. The heat comes from bottom and is circulated throughout the oven by the convection fan. The convection bake mode can be used for a variety of food items, from cakes to breads.

It is also ideal for sponge cakes, pasties and biscuits on multiple racks (3 and 5) at the same time and large quantities of baked foods.

The cakes are positioned with the top rack cakes towards the back of the oven and the lower rack cakes towards the front of the oven. Bake foods with 1" to 1" ½ space between pans and oven walls.

When using the Convection Bake mode, preheat the oven for best results.

Baking time will vary with the size, shape and material of the pan used.

Broil

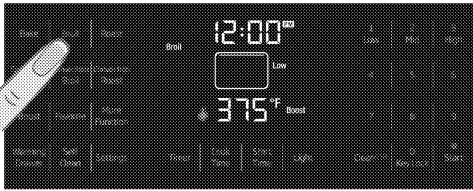

Top heat is on. The broil mode can be used for cuts of meat, poultry and fish. It can also be used to brown breads. The food must be put on a grid in a pan (broiler tray).

Broil food on a single rack with the broiler tray are centrally located with respect to the heating element.

The broil mode has three settings: low (375F), mid (410F), high (465F).

When using the Broil mode, preheat the oven 5-6 minutes for best results.

Turn foods once during the recommended cook time.

The size, weight, thickness, starting temperature and personal preference of doneness will affect broiling times.

Convection Broil

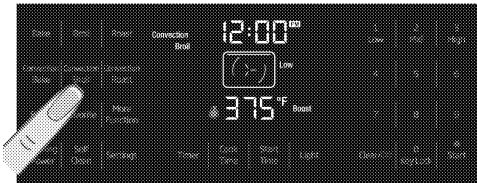

Top heat is on. The heat comes from top and is circulated throughout the oven by the convection fan. The convection broil mode can be used for cuts of meat, poultry and fish. The food must be put on a grid in a pan (broiler tray).

Broil food on a single rack with the broiler tray are centrally located with respect to the heating element.

The convection broil mode has three settings: low (375F), mid (410F), high (465F).

When using the Convection Broil mode, preheat the oven 5-6 minutes for best results.

Turn foods once during the recommended cook time.

The size, weight, thickness, starting temperature and personal preference of doneness will affect broiling times.

Roast

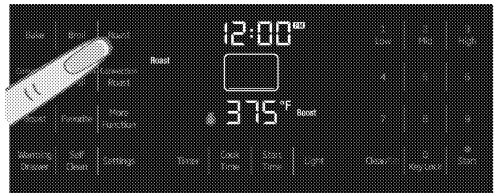

Bottom heat is on. The roast mode can be used for meat and poultry.

Roast food on a single rack with the pan is positioned in the middle of the oven.

When using the Roast mode, preheat the oven for best results.

For best performance, use a pan and grid (roasting tray or broiler tray) under the meat or poultry.

The pan catches grease spills.



WARNING:

You can use a lid or roasting bags in this mode. Follow manufacturer's directions for the roasting bag.

Convection Roast

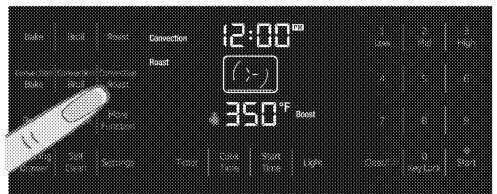

Bottom heat is on. The heat comes from bottom and is circulated throughout the oven by the convection fan. The convection roast mode can be used for meat, poultry and large quantities of roasted foods.

Roast food on a single rack with the pan is positioned in the middle of the oven.

When using the Convection Roast mode, preheat the oven for best results.

For best performance, use a pan and grid (roasting tray or broiler tray) under the meat or poultry.

The pan catches grease spills.



WARNING:

Do not cover meat or use roasting bags in this mode.

Self-cleaning function



WARNING:

If the oven is hot, self-cleaning mode can not be operated until the oven is cold. If the self-cleaning mode malfunctions (powercut), turn the oven off and disconnect the power supply, and call the service.



DANGER:

Hot surfaces cause burns!

Do not touch the product during self-cleaning step and keep children away from it. Keep at least 30 minutes before removing the remnants.



WARNING:

The oven is equipped with self-cleaning function. The oven is heated to approx. 790 °F and existing dirt is burned to ashes. A strong smoke development may arise. Provide for good ventilation.

The self-cleaning should be used after approx. every 10th oven usage.

The self-cleaning has three levels. It can be selected according to level of dirtiness.

Low level (Low): it takes 3 hours.

Medium (Mid): it takes 4 hours.

High (High): it takes 5 hours.



WARNING:

Remove all accessories from the oven.



WARNING:

If the self-cleaning mode malfunctions, turn the oven off and disconnect the power supply. Have it serviced by a qualified technician.



WARNING:

Before operating the self-clean cycle, wipe grease and food soils from the oven. Excessive amount of grease may ignite, leading to smoke damage to your home.



WARNING:

Do not clean the door gasket. Fiberglass gasket is highly sensitive and can get damaged easily. In case of a damage on the oven door gasket, replace with the new one from the authorized service.



WARNING:

Before operating the self-clean cycle, remove dirt from exterior surfaces and oven interior with a damp cloth, wipe grease and food soils from the oven. Excessive amount of grease may ignite, leading to smoke damage to your home. Remove all accessories from the oven.

1. Before the self-cleaning cycle, remove dirt from exterior surfaces and oven interior with a damp cloth.

2. Keep the function knob pressed and turn it clockwise to desired level of "Clean". (Low, Mid or High).

This duration cannot be changed.



WARNING:

The health of some birds and pets is extremely sensitive to the fumes given off during the Self-Cleaning cycle. Always move birds and pets to another closed and well ventilated room. Keep the kitchen well-ventilated during the Self-Cleaning cycle also for your health.

3. If there is a fire in the oven during self-clean, turn the oven off and wait for the fire to go out. Do not force the door open. Introduction of fresh air at self-clean temperatures may lead to a burst of flame from the oven. Failure to follow this instruction may result in severe burns.



CAUTION:

After a clean cycle, remove soil deposits with vinegar water.

 During the Self-Cleaning cycle, the electrical flow to hob burners will be cut. After turning the function and thermostat knob to off position, the door lock will be automatically opened. When the oven gets cool, the electrical flow to hob burners will be started.

 During the Self-Cleaning cycle, the lamp cannot be operated.

 **WARNING:**
If there is a fire in the oven during Self-clean, turn the oven off and wait for the fire to go out. Do not force the door open. Introduction of fresh air at self-clean temperatures may lead to a burst of flame from the oven. Failure to follow this instruction may result in severe burns.

Pizza



Bottom heat is on. The heat comes from bottom and is circulated throughout the oven by the convection fan. The pizza mode can be used for fresh and frozen pizza. Follow manufacturer's directions for frozen pizza.

For best performance, use a pizza pan or baking tray.

You can also use pizza stone but follow manufacturer's directions for the pizza stone.

Bake pizza on a single rack with the pizza pan or baking tray is positioned in the middle of the oven.

When using the Pizza mode, preheat the oven for best results.

Sabbath

Only bake burner is on.

Cook food on a single rack with the pans are positioned in the middle of the oven. Cook foods with 1" to 1 1/2" space between pans and oven walls.

The Sabbath mode can be start with touching

Sabbath function and START button. The temperature must be with range of 125° to 450° F with in the Sabbath mode.





 All control button except CLEAR/OFF button is deactivated when Sabbath mode is active.

 If Sabbath mode is wanted to close, both CLEAR/OFF and LIGHT buttons are touched simultaneously for approximately 2 seconds.

 The maximum time for Sabbath mode is 72 hours if you set the cook time.

 CLEAR/OFF button closes the all heaters when Sabbath mode is active but the appearance of display is not changed.

 **IMPORTANT:**
Light is off when the sabbath function in use. No change in light if you press the button with out sabbath mode.

 **IMPORTANT:**
You can not change the oven temperature after Sabbath starts.

 **IMPORTANT:**
All acustic signals is deactivated when Sabbath mode is active.

 **IMPORTANT:**
If you set the Cook Time in Sabbath mode, all heaters are closed but the appearance of display is not changed after the Cook Time finished.

 The maximum time for Sabbath mode is 75 hours if you do not use Cook Time.

 **WARNING:**
Food Poisoning Hazard: Do not let food sit in oven for more than 1 hour before or after cooking. Doing so can result in food poisoning or sickness.

 **WARNING:**
To avoid permanent damage to the oven bottom finish do not line the oven bottom with any type of foil or liner.

 **WARNING:**
Sabbath mode should be used only on the Jewish Sabbath and Holidays.

 **WARNING:**
The health of some birds and pets is extremely sensitive to the fumes given off during the sabbath mode. Always move birds and pets to another closed and well ventilated room. Keep the kitchen well-ventilated during the sabbath mode also for your health.

 All food should be placed in the oven before the Sabbath begins, since none may be placed in the oven during the Sabbath.

 On the Sabbath the oven door may only be opened once, all the food removed and then closed. On the Holidays, the oven door may be opened/closed at any time as often as desired.

 After recovery from a power failure, the oven will return to the start up screen.

 **WARNING:**
During the Jewish Sabbath and Holidays do not cover the top of burner grates with any kind of cover. Use only cooking utensils with recommended diameters. Make sure ventilation and oven fume outlets are not closed. Otherwise fire hazard and carbon monoxide poisoning can occur.

 **WARNING:**
Prolonged use of cooktop burners can cause fire hazard, carbon monoxide poisoning and death.

 **WARNING:**
Do not use cooktop burners on sabbath mode because of fire hazard, carbon monoxide poisoning and death risk.

 The start time can be adjusted max.12 hours at sabbath mode. Make sure the oven clock shows the correct time of day.

Warm Keep

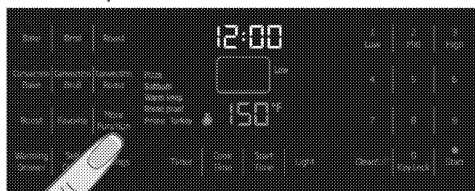

Only bottom heat is on. The warm keep mode will keep hot, cooked foods at serving temperature. Always start with hot food. Cold or room temperature foods cannot be heated or warmed in this mode (except crisping crackers, chips, dry cereal).

Bacteria will grow very rapidly in food that is between 40 and 140°F.

Always preheat the oven before warming food. For best results, do not warm food longer than one hour.

The warm keep mode has three settings: low (150F), mid (170F), high (200F).

Recommendations

Temperature	Food type
Low	Soft rolls, chips, empty dinner plates
Medium	Casseroles, pizza, vegetables, eggs, pastries, biscuits, hard rolls, gravies
High	Roasts, poultry, hamburgers, bacon, potatoes (baked)

 **CAUTION:**
Put the cooked food in heat-safe serving dish on the rack in the oven. Remove serving spoons etc. before placing dishes in the oven.

 **WARNING:**
Do not leave paper products, plastics, canned food or combustible materials in the drawer. They may ignite.

 **WARNING:**
Do not leave paper products, plastics, canned food or combustible materials in the drawer. They may ignite.

**WARNING:****Fire risk!**

Do not store flammable material in the oven and/or in the warming drawer.

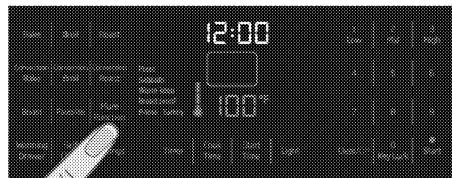
Bread Proof

Only bottom heat is on. The bread proof mode can be used leavening of the bread and pizza dough or other yeast dough.

Use a bowl or a pan with lid or cover.

Proof dough on a single rack with bowl or a pan is positioned in the middle of the oven.

No preheat is necessary.

Prime Turkey

Bottom heat is on. The heat comes from bottom and is circulated throughout the oven by the convection fan. The Prime Turkey mode can be used for whole or parts of turkey.

Roast turkey on a single rack with the pans are positioned in the middle of the oven.

When using the Prime Turkey mode, preheat the oven for best results.

Always use a pan and grid (roasting tray or broiler tray) under whole or parts of Turkey. The pan catches grease spills.

**WARNING:**

Do not cover meat or use roasting bags in this mode.

**IMPORTANT:**

Maximum adjustable cooking time in modes except Sabbath is limited with 6 hours due to safety reasons. It is limited with 5 hours for Self Clean.

**IMPORTANT:**

While adjusting any function, related symbols will flash on the display.

**IMPORTANT:**

Program will be canceled in case of power failure. You must reprogram the appliance.

Warming Drawer

Touch 'Warming Drawer'. 'Warming Drawer' will appear on the display and starts operating in 'Low' level. Touch 2 or 3 from the numbers on the right side to use Warming Drawer in "Mid" and "High" levels.



Touch 'Warming Drawer' to finish operating.

**WARNING:**

The warming drawer will keep hot, cooked foods at serving temperature. Always start with hot food. Cold or room temperature foods cannot be heated or warmed in the warming drawer (except crisping crackers, chips, dry cereal).

Bacteria will grow very rapidly in food that in between 40 and 140°F.

Always preheat the warming drawer before warming food. Do not heat food for more than 3 hours.

**WARNING:**

The purpose of the warming drawer is to hold hot cooked foods at serving temperature. Bacteria will grow in food while it is below 150°F. Do not put cold food in warming drawer. Do not heat food for more than 3 hours. Failure to follow these instructions may result in foodborne illness.

The warming drawer has three settings: low (150F), mid (170F), high (200F).

**WARNING:**

Do not put food, aluminum foil or cookware directly on the bottom of the drawer.

**WARNING:**

Do not touch the heating element or the interior surface of the drawer. These surfaces may be hot enough to cause burns.

Recommendations

Temperature	Food type
Low	Soft rolls, chips, empty dinner plates
Medium	Casseroles, pizza, vegetables, eggs, pastries, biscuits, hard rolls, gravies
High	Roasts, poultry, hamburgers, bacon, potatoes (baked)



CAUTION:

Put the cooked food in heat-safe serving dish on the rack in the warming drawer. Remove serving spoons etc. before placing dishes in the warming drawer.



CAUTION:

Place the wire shelf that you use for oven turning upside down, in the warming/baking drawer .

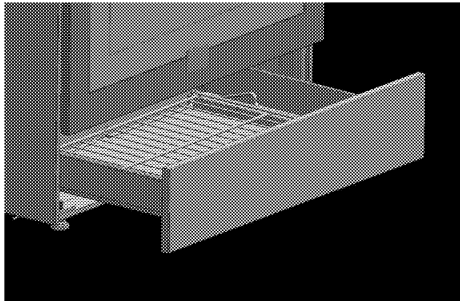

Push 'Warming Drawer' , flashes 'Warming Drawer' on display and will start in 'Low' level. Choose the 2(Mid) or 3(High) on display.



IMPORTANT:

Push the warming drawer to open. Do not pull it towards yourself.



WARNING:

Use care when opening the drawer. Open the drawer a crack and let hot air or steam escape before removing or replacing food. Hot air or steam that escapes can cause burns to hands, face and/or eyes.



IMPORTANT:

It will be activated after about 10 seconds when no key is pressed.

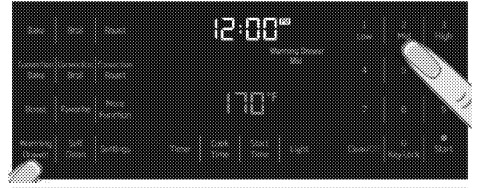

WARNING:

Use this appliance for its intended purpose as described in this owner's manual.



WARNING:

Do not cover in the inner area of the warming drawer with aluminum foils.



CAUTION:

Do not store liquid or water inside the warming drawer.



IMPORTANT:

The warming drawer cannot be used during the self-cleaning function.



IMPORTANT:

The warming drawer turns off automatically after 3 hours.



IMPORTANT:

If you select warming drawer with broil or convection broil function the settings of warmer drawer will not be shown on display and setting of warming drawer cannot be changed. If you select warmer drawer with other oven functions the setting of warming drawer cannot be changed.

**CAUTION:**

Maximum height of foods that can be placed in the warming drawer is approximately 4-5 cm (1.5 - 2 inches).

**WARNING:**

If sabbath and self-clean mode is activated, the warming drawer can not be used.

How to operate the oven control unit**Activating semi-automatic operation mode**

In this operation mode, you may adjust the time period during which the oven will operate (cooking time).

1. Put your meal into the oven and close the oven door.
- 2- Select the desired oven function.
- 3- If you want to change the temperature adjust the temperature using numbers on the right side while °F or °C is flashing.
- 4- For cooking time, touch the 'Cook Time' key once.

Enter the cooking time using numbers on the right keypad while Cook and Time are flashing.

- 5 - Once the cooking time is set, Cook and Time symbols will appear on the display continuously.

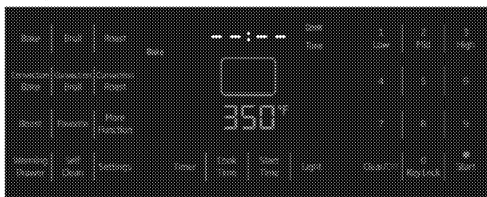

6. If cooking function, temperature and time values are suitable, touch Start to start cooking. Cooking starts and "ON" appears on the display. >>>The oven will be heated up to the preset temperature and will maintain this temperature until the end of the cooking time you selected.

**IMPORTANT:**

All segments of the inner oven temperature symbol (1) will turn on when the oven reaches the set temperature.

- 7- After the cooking is completed, the oven will give an audible warning.
8. To stop the alarm signal, just touch any key.

Switch on fully automatic operation

In this operation mode you can adjust cooking time and end of cooking time.

1. Put your meal into the oven and close the oven door.
- 2- Select the desired oven function.
- 3- If you want to change the temperature adjust the temperature using numbers on the right side while °F or °C is flashing.
- 4- For cooking time, touch the 'Cook Time' key once.

Enter the cooking time using numbers on the right while Cook and Time are flashing.

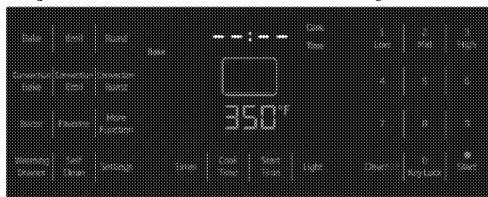

- 5- Touch "Start Time" key once for end of cooking time. Enter end of cooking time using numbers on the right while Start and Time are flashing.
- 6- When end of cooking time is set, end of cooking time and the Start and Time symbols will appear on the display continuously.
- 7- If cooking function, temperature, time and end of cooking time values are suitable, touch "Start" key to start cooking. "Cooking" appears on the display.

» Oven timer automatically calculates the startup time for cooking by deducting the cooking time from the end of cooking time you have set.

- 8- Selected operation mode is activated when the startup time of cooking has come. "ON" appears on display and oven heats up to the adjusted temperature. It maintains this temperature until the end of the cooking time.

**IMPORTANT:**

All segments of the inner oven temperature symbol (1) will turn on when the oven reaches the set temperature.

- 9- After the cooking is completed, the oven will give an audible warning.
10. To stop the alarm signal, just touch any key.

**IMPORTANT:**

If you want to cancel the program after performing semi-automatic or automatic programming, you need to reset the cooking time. You can also switch off the oven by touching the "Clear/Off" key.

Setting the booster(for only electric ovens) (Quick heating)

Use Booster (rapid pre-heating) function to make the oven reach the desired temperature faster.

**IMPORTANT:**

Booster cannot be selected in Warm Keep, Self Clean, Sabbath and Bread Proof cooking positions. Booster will be set by default in other positions. If you do not want to use Booster function, disable it by pressing 'Booster' key.

1. If cooking function, temperature and time values are suitable, touch Start to start cooking. Cooking starts and 'ON' appears on the display.
» 'Booster' disappears from the display as soon as the oven reaches the desired temperature and oven resumes operating in the function it was in before the Booster function.
- 2- Touch the 'Booster' key again in order to enable or disable booster function. If 'Booster' appears on the display, it means it is enabled. If not, it means it is disabled.

Using the key lock

You can prevent oven from being intervened with by activating the key lock function.

**IMPORTANT:**

Key lock can be enabled only when the oven is in Standby position.

Activating the key lock

Key lock is activated by pressing 0-Key Lock key amongst the numbers on the right of display for approximately 3 seconds.

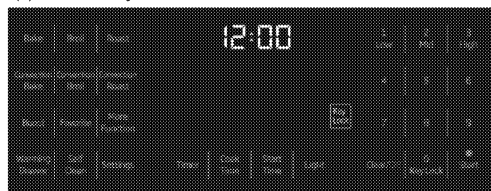

Deactivating the key lock

Key Lock is deactivated by pressing 0-Key Lock key amongst the numbers on the right of display for approximately 3 seconds.

**IMPORTANT:**

Oven keys are not functional when the key lock function is activated. Key lock will be canceled in case of power failure.

Using the timer as an alarm clock

You can use the timer of the product for any warning or reminder apart from the cooking program. The alarm clock has no influence on the functions of the oven. It is only used as a warning. For example, this is useful when you want to turn food in the oven at a certain point of time. Alarm clock will give a signal once the time you set is over.

**IMPORTANT:**

Maximum alarm period can be 6 hours.

To set the alarm:

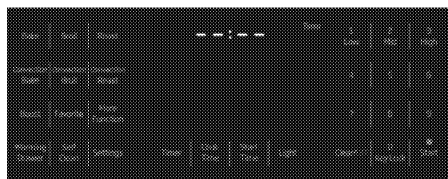

To set the alarm:

Press 'Timer' key on display and set the desired alarm period by entering the alarm period using the numbers on the right of the display. It will be activated after about 10 seconds when no key is pressed.

After the alarm period is over, 'Timer' will start flashing and an alarm signal is heard. To stop the alarm signal, just touch any key.

To cancel the alarm:

Touch 'Timer' key when alarm is set. When you set the time to 00:00, the alarm will be canceled about 10 seconds later and 'Timer' symbol on display will disappear.

Turning the light on and off

Every time you touch 'Light' key on display, it will be turned on if it is off or vice versa.

i **IMPORTANT:**
If Self Clean or Sabbath is active, light will be off at all times. Pressing 'Light' key does not change this.

i **IMPORTANT:**
If internal temperature of the oven exceeds 572 °F, light will be off at all times. Pressing 'Light' key does not change this.

i **IMPORTANT:**
While oven functions are on, all heaters will be switched off when Clear/Off key is pressed.

i **IMPORTANT:**
If oven door is opened when turbo fan is on, turbo fan will be stopped.

i **IMPORTANT:**
If oven door is opened when an oven function is active, all heaters will be deactivated after about 30 seconds.

Using the Favorite Mode

Saving the Favorite Function

When a cooking function is on display, current values will be saved as your favorite meal when you touch "Favorite" key for about 3 seconds.

i **IMPORTANT:**
1 menu will be saved as Favorite meal. Therefore, when you save a new meal, previously saved meal will be deleted and the latest will be stored.

i **IMPORTANT:**
Bake and Set values are preset as "Favorite" meal in the initial setup.

Selecting the favorite menu

Favorite menu will appear on display when you touch "Favorite" key for 1 second when the oven is on.

Touch the 'Start' key to activate cooking.

Standby position of timer

Once the time of the day is set up on the unit, timer display will show the time and the manual cooking symbol will be lit, indicating that the unit

is in Standby position. Manual cooking symbol will always be on the display when the unit is not in use. Neither any indicators nor any heater elements on the unit are active at this position. This indicates that oven can be operated manually without setting the timer. If you wish to make a programmed cooking operation in the oven, please follow the steps to activate the oven timer on page 27.



OFF position of timer

You can bring the timer to the OFF position. At OFF position even turn on the function knob, timer do not allow heaters on. To set timer to the OFF position when it is at Standby mode:

1. Press to button 2.
2. If you can not see 0:00 on display, bypassing 5 and 6 buttons adjust it to 0:00.
3. If you see already 0:00 on the display, by pressing button 6 make display 0:01. Then by pressing button 5 make it 0:00 again.
4. You will hear alarm sound. Press button 3 to switch off the alarm sound. You will see "AUTO" is blinking and the display shows time of the day.

Now timer is in OFF position. It is the same position when you first time connect your product to the main supply. First cleaning of the appliance

i **IMPORTANT:**
When removing appliance for cleaning and/or service;
Disconnect AC power supply.
Carefully remove the range by pulling outward.
Range is heavy, use care in handling.

**NOTICE:**

The surface might get damaged by some detergents or cleaning materials. Do not use aggressive detergents, cleaning powder/cream or any sharp objects. Be careful to avoid steam burn. Some cleaners can produce noxious fumes if applied to a hot surface.

1. Remove all packaging materials.
2. Wipe the surfaces of the appliance with a damp cloth or sponge and dry with a cloth.

Initial Heating**WARNING:**

Hot surfaces may cause burns! Do not touch the hot surfaces of the appliance. Use oven gloves. Keep children away from the appliance.



Smell and smoke may emit during first heating. Ensure that the room is well ventilated.

Any production residues or conservation layers must be burnt off before the first use. Heat up the appliance for about 30 minutes and then switch it off.

Initial use**First cleaning of the appliance**

The surface might get damaged by some detergents or cleaning materials. Do not use aggressive detergents, cleaning powders/creams or any sharp objects during cleaning.

Do not use harsh abrasive cleaners or sharp metal scrapers to clean the oven door glass since they can scratch the surface, which may result in shattering of the glass.

1. Remove all packaging materials.
2. Wipe the surfaces of the appliance with a damp cloth or sponge and dry with a cloth.

Initial heating

Heat up the product for about 30 minutes and then switch it off. Thus, any production residues or layers will be burnt off and removed.

**WARNING:**

Hot surfaces cause burns!

Product may be hot when it is in use. Never touch the hot burners, inner sections of the oven, heaters and etc. Keep children away. Always use heat resistant oven gloves when putting in or removing dishes into/from the hot oven.

Gas oven

1. Take all baking trays and the wire grill out of the oven.
2. Close the oven door.
3. Select the bake function.
4. Set the temperature 350° F.
5. Operate the oven about 30 minutes.
6. Turn off your oven.

Broil

1. Take all baking trays and the wire grill out of the oven.
2. Select the broil function.
3. Set the broil level to "HI".
3. Operate the broil about 30 minutes.
4. Turn off your oven.



Smoke and smell may emit for a couple of hours during the initial operation. This is quite normal. Ensure that the room is well ventilated to remove the smoke and smell. Avoid directly inhaling the smoke and the smell that emits.

4 How to use the hob

General information about cooking

 **WARNING**
Never fill the pan with oil more than one third of it. Do not leave the hob unattended when heating oil. Overheated oils bring risk of fire.
Never attempt to extinguish a possible fire with water! When oil catches fire, cover it with a fire blanket. Turn off the hob if it is safe to do so and call the fire department.

 **CAUTION**
Never extend the flame beyond the outer edge of the cooking utensil. A higher flame wastes energy, and increases your risk of being burned by the flame

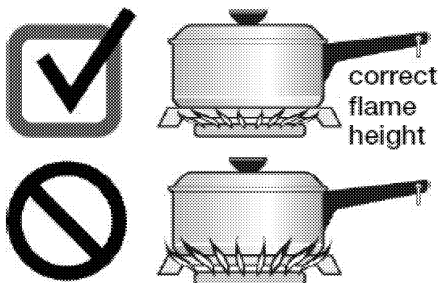

- Before frying foods, always dry them well and gently place into the hot oil. Ensure complete thawing of frozen foods before frying.
- Do not cover the vessel you use when heating oil.
- Place the pans and saucepans in a manner so that their handles are not over the hob to prevent heating of the handles. Do not place unbalanced and easily tilting vessels on the hob.
- Do not place empty vessels and saucepans on cooking zones that are switched on. They might get damaged.
- Operating a cooking zone without a vessel or saucepan on it will cause damage to the product. Turn off the cooking zones after the cooking is complete.

- As the surface of the product can be hot, do not put plastic and aluminum vessels on it. Such vessels should not be used to keep foods either.
 - Use flat bottomed saucepans or vessels only.
 - Put appropriate amount of food in saucepans and pans. Thus, you will not have to make any unnecessary cleaning by preventing the dishes from overflowing. Do not put covers of saucepans or pans on cooking zones.
- Place the saucepans in a manner so that they are centered on the cooking zone. When you want to move the saucepan onto another cooking zone, lift and place it onto the cooking zone you want instead of sliding it.

Gas cooking

- Size of the vessel and the flame must match each other. Adjust the gas flames so that they will not extend the bottom of the vessel and center the vessel on saucepan carrier.

Using the hobs

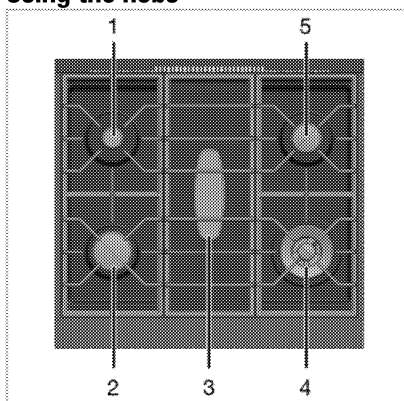

- 1 Normal burner 18-22 cm (7- 8.66 inches)
- 2 Rapid burner 22-26 cm (8.66 - 10.2 inches)
- 3 Elongated burner min. 36-15 cm (14.17 - 5.9 inches)
- 4 Wok burner 24-28 cm (9.44 - 11 inches)
- 5 Normal burner 18-22 cm (7- 8.66 inches) is list of advised diameter of pots to be used on related burners.

Igniting the gas burners

Gas burners are controlled with gas hob knobs.

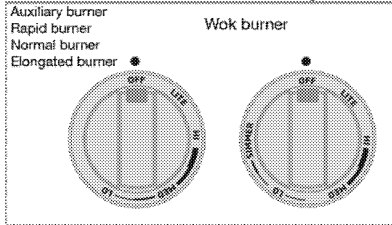

1. Keep burner knob pressed.
2. Turn it counter clockwise to level "LITE".
Ignition starts at "LITE" position, combustion takes place towards the "HI" cooking position.
3. Adjust it to the desired cooking power.

Turning off the gas burners

Turn the knob to off (upper) position.

Wok burner

Wok burners help you to cook faster. Wok, which is particularly used in Asian kitchen is a kind of deep and flat fry-pan made of sheet metal, which is used to cook minced vegetable and meat at strong flame in a short time.

Since meals are cooked at strong flame and in a very short time in such fry-pans that conduct the heat rapidly and evenly, the nutrition value of the food is preserved and vegetables remain crispy. You can use wok burner for regular saucepans as well.

5 How to operate the oven

General information on baking, roasting and broiling



WARNING

Hot surfaces cause burns!
Product may be hot when it is in use. Never touch the hot burners, inner sections of the oven, heaters and etc. Keep children away. Always use heat resistant oven gloves when putting in or removing dishes into/from the hot oven.



DANGER:

Be careful when opening the oven door as steam may escape.
Exiting steam can scald your hands, face and/or eyes.

Tips for baking

- Use non-sticky coated appropriate metal plates or aluminum vessels or heat-resistant silicone moulds.
- Make best use of the space on the rack.
- Place the baking mould in the middle of the shelf.
- Select the correct rack position before turning the oven or Broil on. Do not change the rack position when the oven is hot.
- Always place oven racks in desired location while oven is cool. If rack must be moved while oven is hot, do not let potholder contact hot heating element in oven.
- Keep the oven door closed.

Tips for roasting

- Seasoning with lemon juice and black pepper will improve the cooking performance when cooking a whole chicken, turkey or a large piece of meat.
- Meat with bones takes about 15 to 30 minutes longer before it is cooked than a roast of the same size without bones.
- You should calculate about 4 to 5 minutes cooking time per centimeter height of the meat.
- Let meat rest in the oven for about 10 minutes after the cooking time. The juice is better distributed all over the roast and does not run out when the meat is cut.

- Fish in a fire-resistant dish should be placed on the rack at the medium or lower level.

Tips for broiling

Broiling is ideal for cooking meat, fish and poultry and will achieve a nice brown surface without it drying out to much. Flat pieces, meat skewers and sausages are particularly suited for broiling as are vegetables with a high water content such as tomatoes and onions.

- Distribute the pieces to be broiled on the wire shelf.
- If the broiling is on the wire shelf, locate a dripping pan under it in order to collect the fat.
- Add some water in dripping pan for easy cleaning.



Fire danger due to food which is unsuitable for grilling!

Only use food for grilling which is suitable for intensive grilling heat. Do not place the food too far in the back of the grill. This is the hottest area and fat food may catch fire.



WARNING

Do not insert your finger or any other object in the holes of the back wall of the oven.

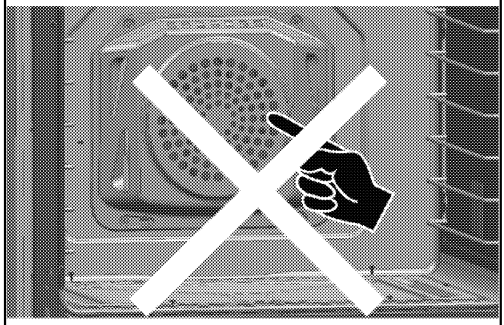

Fan only runs if necessary for improving performance of cooking and saving the energy of the oven.

Switch on the gas oven

The gas oven is automatically ignited by means of the function and thermostat knobs.

1. Keep the function knob pressed and turn it **clockwise** to desired operating mode.
2. Keep the thermostat knob pressed and turn it **clockwise** to the desired temperature.
3. After 30-75 seconds, the burner will ignite.



After turning the function and thermostat knob to desired levels, gas igniter is going to hot and glow. When the igniter reaches a certain temperature, gas will begin to flow and the burner will be ignited.
The illumination during ignition is normal.

Switch off the gas oven

1. Turn the function and thermostat knobs to off (upper) position.

Cooking times table



1st rack of the oven is the **bottom** rack.



Maximum load capacity of oven tray: 4 kg (8.8 lb).



The timings in this chart are meant as a guide. Timings may vary due to temperature of food, thickness, type and your own preference of cooking.

Baking and roasting

Food	Cooking Mode	Oven Temperature (°F)	Number of Racks	Rack Position	Time (min.)	Pan Size&Type	Explanation
Sponge Cake	Bake	375	Single	3	30-40	8" or 9" (203 or 228 mm) round	The cakes are positioned in the middle of the oven. Bake foods with 1" to 1 ½ (25 to 38 mm) space between pans and oven walls.
Sponge Cake	Convection Bake	350	Multiple	3&5	25-35	8" or 9" (203 or 228 mm) round	The cakes are positioned with the top rack cakes towards the back of the oven and the lower rack cakes towards the front of the oven. Bake foods with 1" to 1 ½ (25 to 38 mm) space between pans and oven walls.
Loaf (leavened*)	Convection Bake	400	Single	3	30-40	Baking tray	-
Puff pastry	Convection Bake	375	Multiple	3&5	20-30	Cookie sheet	The sheets are positioned with the top rack sheet towards the back of the oven and the lower rack sheet towards the front of the oven. Bake foods with 1" to 1 ½ (25 to 38 mm) space oven
Fresh pizza,	Pizza	425	Single	2	8-15	Pizza pan or	-

thin						Baking tray	
Fresh pizza, thick	Pizza	425	Single	2	13-20	Pizza pan or Baking tray	-
Frozen pizza, thick	Pizza	425	Single	2	8-15	Pizza pan or Baking tray	
Chicken, whole (4-4.5 lbs.)	Convection Roast	375	Single	2	120-140	Roasting pan or broilertray	Minimum internal temperature is 180°F in thigh
Turkey, whole, unstuffed (18-20 lbs.)	Prime Turkey	325	Single	1	180-210	Roasting pan	Minimum internal temperature is 180°F in thigh. Foil the top surface of turkey to prevent over-browning in last 30 minutes of the cooking, if necessary.
Turkey, whole, unstuffed (18-20 lbs.)	Roast	325	Single	1	270-300	Roasting pan	Minimum internal temperature is 180°F in thigh. Foil the top surface of turkey to prevent over-browning in last 30 minutes of the cooking, if necessary.
Sirloin, boneless (4-4.5 lbs.)	Convection Roast	325	Single	3	90-120	Broilertray	Internal temperature is 145°F (medium rare), 160°F (medium)
Toast bread	Broil	High	Single	4	1:30-2	Broilertray	Place broiler traycentrally located with respect to the heating element.
Chicken thigh (2-2.5 lbs)	Broil	High	Single	4	Side 1: 17-20 Side 2: 12-15	Broilertray	Place broiler traycentrally located with respect to the heating element. Minimum internal temperature is 180°F in thigh.
Ground beef (0.3"-0.5" thick, 6 patties)	Broil	High	Single	4	Side 1: 5-7 Side 2: 3-5	Broilertray	Place broiler traycentrally located with respect to the heating element.
Hamburger, frozen (0.3"-0.5" thick, 6 patties)	Broil	High	Single	4	Side 1: 6-9 Side 2: 2-4	Broilertray	Place broiler traycentrally located with respect to the heating element.
*Leavening	Bread Proof	100	Single	3	35-45	Bowl or pan with cover	
**It is suggested to perform preheating for all foods cooking. It is suggested to perform 5-6 minutes preheating for all foods broiling.							

**WARNING**

Hot surfaces may cause burns! Keep children away from the product.

Close oven door during grilling.



After operating the oven, levels, gas igniter is going to hot and glow. When the igniter reaches a certain temperature, gas will begin to flow and the burner will be ignited. The illumination during ignition is normal.

For equipment with a cooling fan

The cooling fan cools the front of the products.

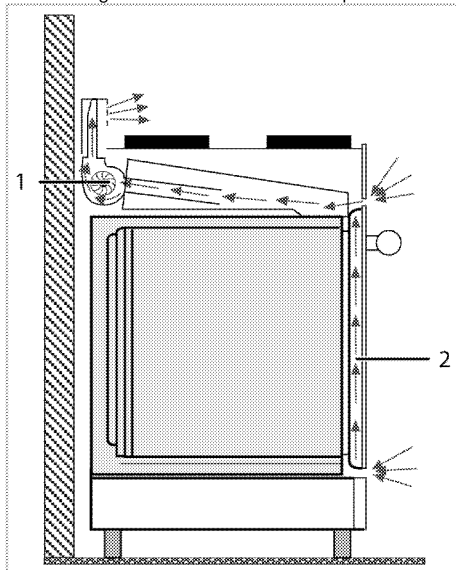

1 Cooling fan motor

2 Front door

**IMPORTANT:**

The cooling fan continues to operate for about 20-30 minutes after the oven is switched off.

6 Maintenance and care

General information

Service life of the product will extend and the possibility of problems will decrease if the product is cleaned at regular intervals.



DANGER:

Disconnect the product from mains supply before starting maintenance and cleaning works.

There is the risk of electric shock!



DANGER:

Allow the product to cool down before you clean it.

Hot surfaces may cause burns!

- Keep the appliance area clear and free from combustible materials, gasoline and other flammable vapors and liquids.
- Do not obstruct the flow of combustion and ventilation air.
- Clean the product thoroughly after each use. In this way it will be possible to remove cooking residues more easily, thus avoiding these from burning the next time the appliance is used.
- No special cleaning agents are required for cleaning the product. Use warm water with washing liquid, a soft cloth or sponge to clean the product and wipe it with a dry cloth.
- Always ensure any excess liquid is thoroughly wiped off after cleaning and any spillage is immediately wiped dry.
- Do not use cleaning agents that contain acid or chloride to clean the stainless or inox surfaces and the handle. Use a soft cloth with a liquid detergent (not abrasive) to wipe those parts clean, paying attention to sweep in one direction.



The surface might get damaged by some detergents or cleaning materials.

Do not use aggressive detergents, cleaning powders/creams or any sharp objects during cleaning.

Do not use harsh abrasive cleaners or sharp metal scrapers to clean the oven door glass since they can scratch the surface, which may result in shattering of the glass.



Do not use steam cleaners to clean the appliance as this may cause an electric shock.

Cleaning the burner/plate

Gas hobs

1. Remove and clean the saucepan carriers and burner caps.
2. Clean the hob.
3. Refit the burner caps and make sure that they are seated correctly.
4. When installing the pan supports, pay attention to place the saucepan carriers so that the burners are centered.

Cleaning the control panel

Clean the control panel and knobs with a damp cloth and wipe them dry.



Do not remove the control buttons/knobs to clean the control panel.

Control panel may get damaged!

Cleaning the oven

No oven cleaner or any other special cleaning agent is required for cleaning the oven. It is recommended to wipe the oven with a damp cloth while it is still warm.

Clean oven door

To clean the oven door, use warm water with washing liquid, a soft cloth or sponge to clean the product and wipe it with a dry cloth.



Don't use any harsh abrasive cleaners or sharp metal scrapers for cleaning the oven door. They could scratch the surface and destroy the glass.

Removing the oven door

When removing the oven door

Make sure oven is cool and power to the oven has been turned off before removing the door. Failure to do so could result in electrical shock or burns.

The oven door is heavy and parts of it are fragile. Use both hands to remove the oven door. The door front is glass. Handle carefully to avoid breakage.

Grasp only the sides of the oven door. Do not grasp the handle as it may swing in your hand and cause damage or injury.

Failure to grasp the oven door firmly and properly could result in personal injury or product damage.

To avoid injury from hinge bracket snapping closed, be sure that both levers are securely in place before removing the door. Also, do not force door open or closed—the hinge could be damaged and injury could result.

Do not lay removed door on sharp or pointed objects as this could break the glass. Lay on a flat, smooth surface, positioned so that the door cannot fall over.

Oven door can be removed in order to clean the inside of oven easily

1. Open the oven door completely.
2. Press the hinge clamps located at both sides of the door backwards.

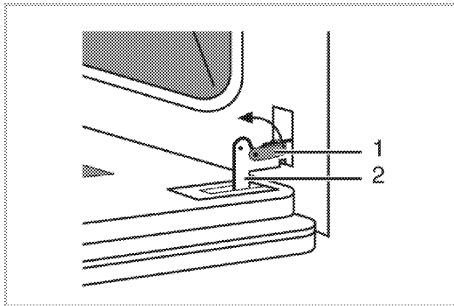

- 1 Hinge clamp
- 2 Hinge

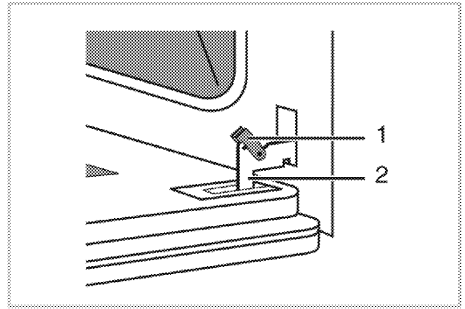

3. Move the oven door to a slightly inclined position.
4. Raise the oven door forwards with your two hands.
5. Once you complete cleaning, perform the same procedure in reverse order to reinstall the oven door.

i Once you complete cleaning, perform the same procedure in reverse order to reinstall the oven door.

Replacing the oven lamp



DANGER:

Before replacing the oven lamp, make sure that the product is disconnected from mains and cooled down in order to avoid the risk of an electrical shock.
Hot surfaces may cause burns!



The oven lamp is a special electric light bulb that can resist up to 300°C (573 °F). See *Technical specifications* for details. Oven lamps can be obtained from Authorised Service Agents or technician with license.



Position of lamp might vary from the figure.

If your oven is equipped with a square lamp:

The oven lights can be illuminated with lamp button. The lights are switched on when the door is opened or when the oven is in a cooking cycle. The oven lights are not illuminated during self clean. Each light assembly consist of a removable lens, a light bulb as well as a light socket housing that is fixed in place. Light bulb replacement is considered to be a routine maintenance item.

The oven lights are not illuminated during self clean.

1. Turn off power at the main power supply (your fuse or breaker box).
2. Remove the wire racks as described. See *Cleaning the oven*.

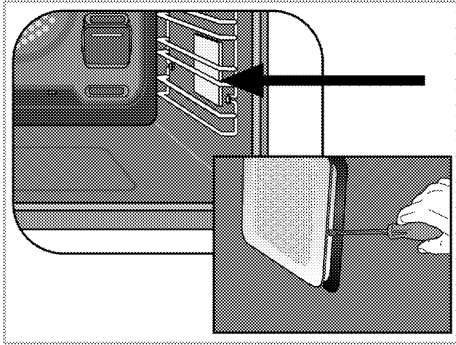

3. Remove the protective glass cover with a screwdriver.
4. Pull out oven lamp and replace it with new one.
5. Install the glass cover and then the wire racks.

7 General information

Overview

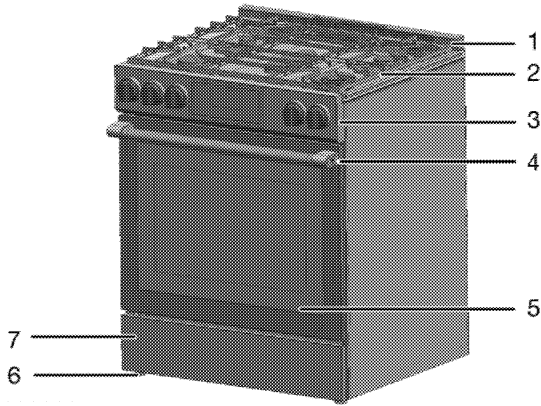

- | | | | |
|---|---------------|---|----------------|
| 1 | Splashback | 5 | Front door |
| 2 | Burner plate | 6 | Foot |
| 3 | Control panel | 7 | Warming drawer |
| 4 | Handle | | |

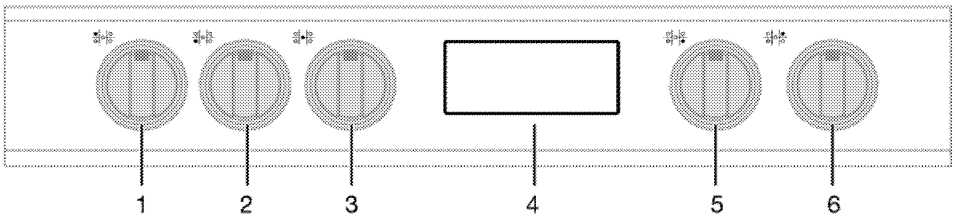

- | | | | |
|---|-------------------------|---|--------------------------|
| 1 | Normal burner Rear left | 4 | Digital Timer |
| 2 | Rapid burner Front left | 5 | Wok burner Front right |
| 3 | Elongated burner Middle | 6 | Normal burner Rear right |

Technical specifications

GENERAL	
External dimensions (height / width / depth)	36 x 29 ^{13/16} x 29 ^{1/8} inches (914 x 757 x 739 mm)
Voltage / frequency	110- 120V~60Hz
Cable type / section	SJT 3x18 AWG / max. 6 ft
Fuse protection	Min. 10 A
Total electric power	1030 Watt
Gas type / pressure	Natural Gas 5" WC / LP Gas 10" WC
Burners	
Rear left	Normal burner
Power	8000 BTU/h/ 6500 BTU/h
Front left	Rapid burner
Power	12500 BTU/h / 9250 BTU/h
Middle	Elongated burner
Power	10000 BTU/h / 8250 BTU/h
Front right	Wok burner
Power	16000 BTU/h/ 16500 BTU/h
Rear right	Normal burner
Power	8000 BTU/h/ 6500 BTU/h
OVEN/GRILL	
Main oven	Gas oven
Inner lamp	2 x 40 W
Oven power consumption	16500 BTU/h / 17000 BTU/h
Total power consumption	71000 BTU/h / 64000 BTU/h
Broil power consumption	13000 BTU/h / 11000 BTU/h
Warming Drawer	380 W



Technical specifications may be changed without prior notice to improve the quality of the product.



Figures in this manual are schematic and may not exactly match your product.



Values stated on the product labels or in the documentation accompanying it are obtained in laboratory conditions in accordance with relevant standards. Depending on operational and environmental conditions of the product, these values may vary.

Package contents



WARNING:

Pull the oven rack to the stop-lock position when loading and unloading food from the oven. This helps prevent burns from touching hot surfaces of the door and oven walls.



CAUTION:

When you are using a rack in the lowest position (A), you will need to use caution when pulling the rack out. We recommend that you pull the rack out several inches and then, using two pot holders, pull the rack out by holding the sides of it. The rack is low and you could be burned if you place your hand in the middle of the rack and pull all the way out. Be very careful not to burn your hand on the door when using the rack in the lowest position (A).



Accessories supplied can vary depending on the product model. Not every accessory described in the user manual may exist on your product.

1. **User manual**

2. **Wire Shelf**

Used for roasting and for placing the food to be baked, roasted or cooked in casserole dishes to the desired rack.

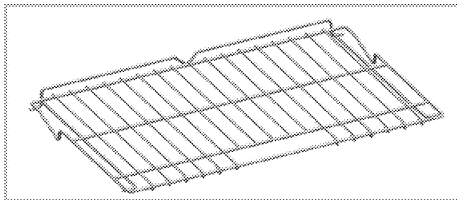

3. **Wire Shelf with telescopic rails**

Used for roasting and for easily placing the food to be baked, roasted or cooked in casserole dishes to the desired rack.

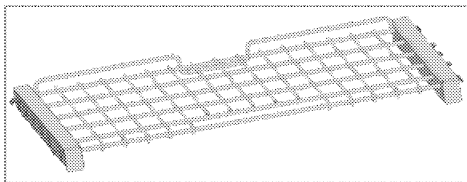

4. **Placing the wire shelf with telescopic rails and tray onto the racks properly**

Telescopic rails allow you to install and remove the trays and wire shelf easily.

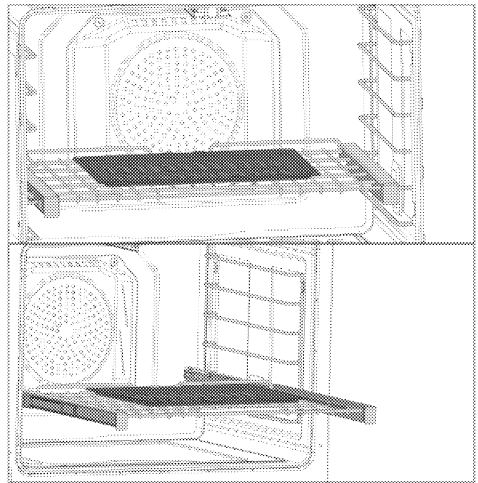

How to remove the wire shelf with telescopic rails

You can remove the wire shelf with telescopic rails by first lifting it up and then pulling it towards you.

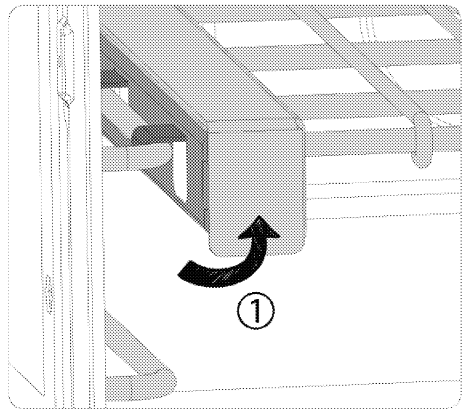

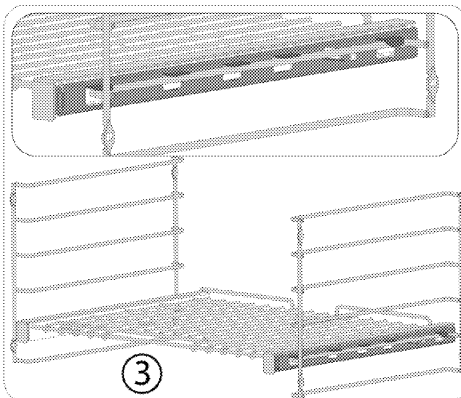
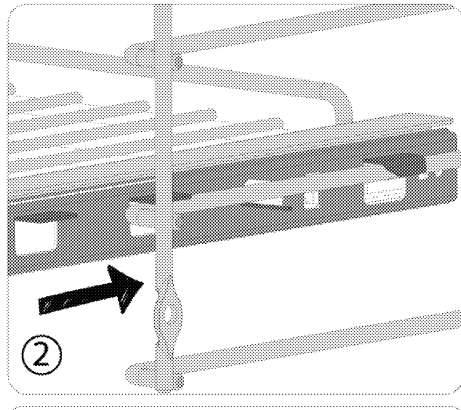
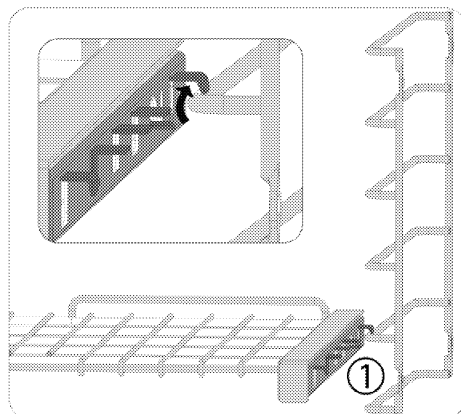
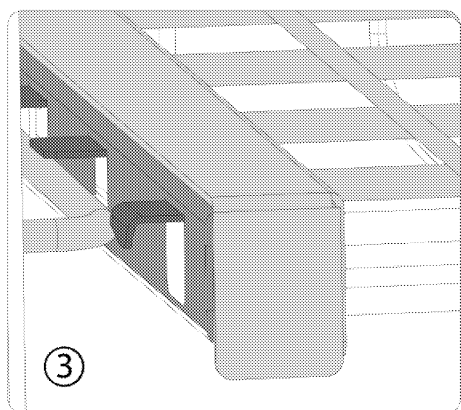
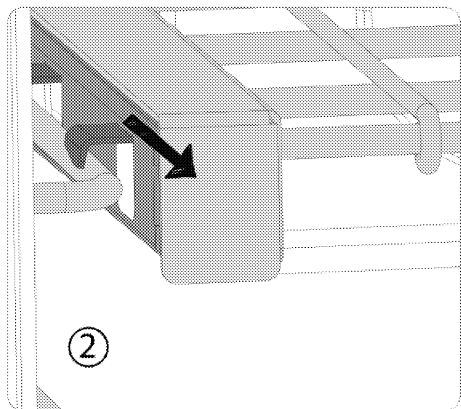

How to reattach the wire shelf with telescopic rails

To reattach the wire self with telescopic rails, the procedures applied when removing it must be repeated from the end to the beginning, respectively.

Injector table



WARNING:

This product can be converted to LP Gas. Gas conversion must always be performed by Authorized Service Agents.

According to the gas type that will be used correct injector type must be used, please find LPG/NG table below.

0-2000 ft (0-610 m)						
Position hob zone	8000 BTU/hRear left	12500 BTU/h Front left	16000 BTU/h Front right		8000 BTU/h Rear right	10000 BTU/h Middle
Gas type / Gas pressure			inner	outer		
Natural Gas 5"	125	155	75	120	125	139
	Oven (16500BTU/h)			Grill (13000BTU/h)		
Natural Gas 5"	190			165		

0-2000 ft (0-610 m)						
Position hob zone	6500 BTU/hRear left	9250 BTU/h Front left	16500 BTU/h Front right		6500 BTU/h Rear right	8250 BTU/h Middle
Gas type / Gas pressure			inner	outer		
LP Gas 10"	75	94	46	80	75	85
	Oven(17000BTU/h)			Grill (11000BTU/h)		
LP Gas 10"	117			98		

2000-4500 ft (610-1370 m)						
Position hob zone	8000 BTU/hRear left	12500 BTU/h Front left	16000 BTU/h Front right		8000 BTU/h Rear right	10000 BTU/h Middle
Gas type / Gas pressure			inner	outer		
Natural Gas 5"	125	155	75	115	125	139
	Oven (16500BTU/h)			Grill (13000BTU/h)		
Natural Gas 5"	184			158		

2000-4500 ft (610-1370 m)						
Position hob zone	6500 BTU/hRear left	9250 BTU/h Front left	16500 BTU/h Front right		6500 BTU/h Rear right	8250 BTU/h Middle
Gas type / Gas pressure			inner	outer		
LP Gas 10"	75	87	46	78	75	85
	Oven(17000BTU/h)		Grill (11000BTU/h)			
LP Gas 10"	117		95			

8 Troubleshooting

Oven emits steam when it is in use.

- It is normal that steam escapes during operation. >>>*This is not a fault.*

Product emits metal noises while heating and cooling.

- When the metal parts are heated, they may expand and cause noise. >>>*This is not a fault.*

There is no ignition spark.

- No current. >>>*Check fuses in the fuse box.*

There is no gas.

- Main gas valve is closed. >>>*Open gas valve.*
- Gas pipe is bent. >>>*Install gas pipe properly.*

Burners are not burning properly or at all.

- Burners are dirty. >>>*Clean burner components.*
- Burners are wet. >>>*Dry the burner components.*
- Burner cap is not mounted safely. >>>*Mount the burner cap properly.*
- Gas valve is closed. >>>*Open gas valve.*



Consult the Authorised Service Agent or technician with licence or the dealer where you have purchased the product if you can not remedy the trouble although you have implemented the instructions in this section. Never attempt to repair a defective product yourself.

9 Removing the Package

1

Ribbon

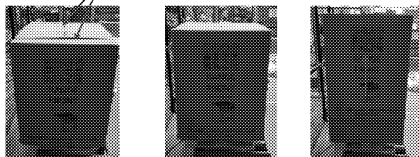

2

Upper Frame

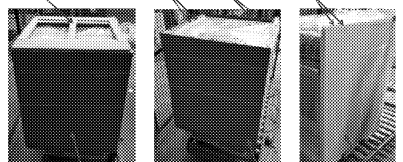

Rear MDF

Front MDF

Nylon bag

A: 18x40 Wooden support

Remove upper frame and rear and front MDFs.

3



Remove cut-out styrofoams and blue tapes.

4



Remove nylon bag on the product.

5

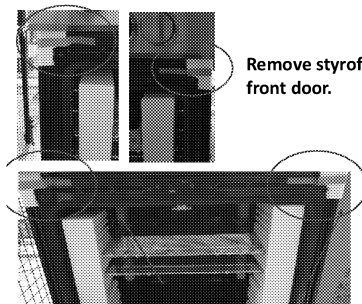

Remove styrofoams of the front door.

6

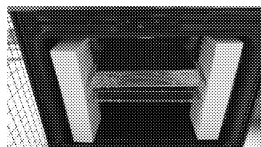

Remove grill styrofoams and shrink packaging.



7

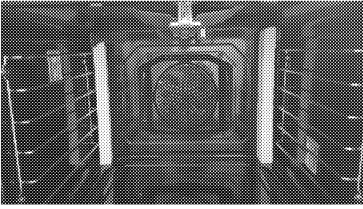

Remove protective styrofoams on chassis inside the.

8

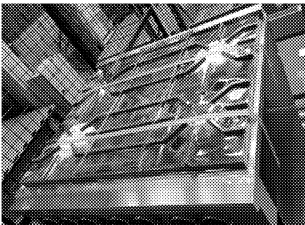

Remove upper pet and blue tapes on it.

9



Remove blue tapes on the edges of cast grill.

10



Remove styrofoams on pet and the lower pet.

11

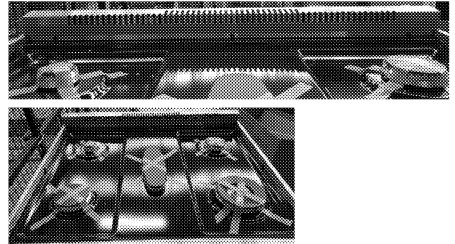

Remove blue tapes securing splash back and burner caps.

12

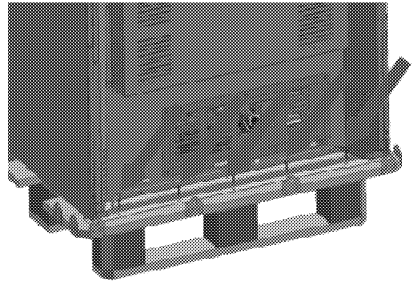

Remove 5 screws

13

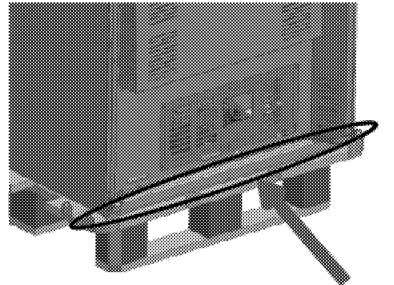

Remove this metal support

14

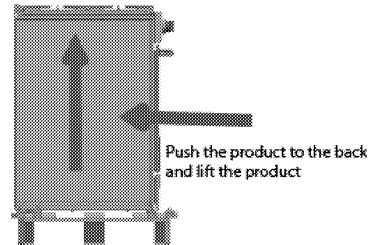

Push the product to the back and lift the product

10 BEKO US RESIDENTIAL PRODUCT WARRANTY

The warranties provided by Beko in these statements only apply to Beko appliance sold to the original purchaser or homeowner in the US (Including Alaska, Hawaii, Puerto Rico and the US Virgin Islands) and The Cayman Islands

The factory warranty applies only to products purchased through an authorized dealer or authorized reseller. Go to www.bekoappliances.com/where-to-buy for a list of authorized dealers. Products purchased through non-authorized dealers and wholesalers will not be covered under the manufactures warranty

The warranty is not transferable. To obtain warranty service, please contact your dealer or contact us at

<https://www.bekoappliances.com/support/beforecallcenter/>

You will need your product model number, serial number, retailer name and address, where purchased and purchase date / installation date. This warranty gives you specific legal rights, and you may also have other rights which vary from state to state. Also, please make sure you register your product for warranty at:

<https://www.bekoappliances.com/product-registration/>

2 year (*) full warranty from date of first Installation (All Beko Products)

Beko will repair or replace at no cost to the consumer any defective parts product if used under normal household conditions

(Warranty is void if the product is used commercially e.g., bed + breakfast, nursing home etc.). Service must also be performed by an authorized Beko service agency. (Cosmetic defects must be reported within 10 business days from installation). 1 year warranty on the accessories is for the parts only and does not include labor.

3rd thru 5th year (*, **) Sealed System Warranty on refrigerators - Parts Only

Beko will provide (No Charge) any compressor, evaporator, condenser and filter Dryer to the consumer if material defects or workmanship have caused the damage or failure of these components.

(Trip and Labor charges are the responsibility of the consumer)

3rd thru 10th year (*, **) ProSmart™ Inverter Motor on Dishwashers – Part Only

Beko will provide (No Charge) a ProSmart Inverter Main Wash Motor if material defects or workmanship have caused the damage or failure of this component.

(Trip and Labor charges are the responsibility of the consumer)

Disclaimers of warranties and exclusions:

Warranty does not cover service costs by an authorized service agent to correct installation, electrical problems or educational instruction on the use of the electric and gas ranges. The warranty also does not cover defects or damage caused by an act of God (such as storms, floods, fires, mudslides, etc.), damage cause by use of the electric and gas ranges for purposes other than those for

which it was designed, misuse, abuse, accident, alteration, improper installation, maintenance, travel fees, service calls outside normal service hours, pick up and delivery, any food loss due to product failure, unauthorized service work or work.

This product is fully tested and went through official quality assurance inspections before leaving the original manufacturing site. Warranty terms for this Beko household appliance is not valid if the product is altered, tampered, modified, additional parts assembled, fixed and re-packed by an authorized distributor, servicer, a third party retailer, reseller or by any other unauthorized person(s).

TO THE EXTENT PERMITTED BY LAW, THIS WARRANTY IS IN LIEU OF ALL OTHER EXPRESSED AND IMPLIED WARRANTIES, INCLUDING THE IMPLIED WARRANTIES OF MERCHANTABILITY AND FITNESS FOR A PARTICULAR PURPOSE. BEKO UNDERTAKES NO RESPONSIBILITY FOR THE QUALITY OF THIS PRODUCT EXCEPT AS OTHERWISE PROVIDED IN THIS WARRANTY STATEMENT. BEKO ASSUMES NO RESPONSIBILITY THAT THE PRODUCT WILL BE FIT FOR ANY PARTICULAR PURPOSE FOR WHICH YOU MAY BE BUYING THIS PRODUCT, EXCEPT AS OTHERWISE PROVIDED IN THIS WARRANTY STATEMENT.

Beko does not assume any responsibility for incidental or consequential damages. Such damages include, but are not limited to, loss of profits, loss of savings or revenue, loss of use of the electric and gas ranges or any associated equipment, cost of capital, cost of any substitute equipment, facilities or services, downtime, the claims of third parties, and injury to property. Some states do not allow the exclusion or limitation of incidental or consequential damages, so the above limitations or exclusion may not apply to you.

(*) Installation date shall refer to either purchase date or 5 business days after delivery of the product to the home, whichever is later.

() Parts replaced will assume the identity of the original parts + their original warranty.**

No Other Warranties. This Warranty Statement is the complete and exclusive warranty from the manufacturer. No employee of Beko or any other party is authorized to make any warranty statements in addition to those made in this Warranty Statement.

Please keep this warranty card, user manual and your sales slip for future reference.

HOW TO CONTACT BEKO

Please contact Beko US at 1 (888) 352-2356 and select option 2 for customer service

HOW TO GET SERVICE

Please contact your authorized Beko dealer or visit www.bekoappliances.com to locate and get information for the closest authorized Beko service center.

