

**PRODUCT SPECIFICATIONS**

Elkay Quartz Classic<sup>®</sup> 33" x 18-1/2" x 5-1/2" Double Bowl Undermount ADA Sink with Perfect Drain<sup>®</sup>. Sink is molded with up to 80% natural quartz and high performance acrylic resins that are non-porous providing superior heat, scratch, fade and stain resistance. Naturally sound deadening and Rear Center drain placement.



<b>Installation Type:</b>	Undermount
<b>Material:</b>	Quartz
<b>Special Features:</b>	Perfect Drain
<b>Finish:</b>	Black (BK), Greystone (GS), Mocha (MC), White (WH)
<b>Number of Bowls:</b>	2
<b>Sink Dimensions:</b>	33" x 18-1/2" x 6-7/8"
<b>Bowl 1 Dimensions:</b>	14-1/4" x 16-3/16" x 5-1/2"
<b>Bowl 2 Dimensions:</b>	14-1/4" x 16-3/16" x 5-1/2"
<b>Drain Size:</b>	3-5/8" (92mm)
<b>Drain Location:</b>	Rear Center
<b>Minimum Cabinet Size:</b>	36"
<b>Mounting Hardware:</b>	Part # 54300408 included
<b>Template Included:</b>	Yes
<b>Cutout Template #:</b>	<a href="#">1000003496</a>

Template is available for download at [elkay.com](#). CAD software will be required to open the template.

**Perfect Drain:** Seamlessly molded collar eliminates the gap between a traditional drain and the sink for a more sanitary and gap free installation. Select garbage disposers can be installed on either sink bowl for user convenience. Please see our Garbage Disposer Compatibility Guide.

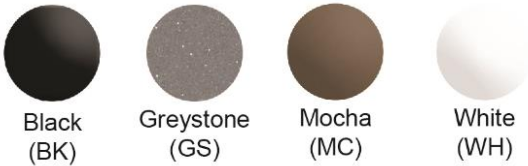

**Included with Product:** Two LKPDQ1CR Perfect Drains and strainers.

A Century of Tradition and Quality. For more than 100 years, Elkay has been making innovative products and providing exceptional customer care. We take pride in offering plumbing products that make life easier, inspire change and leave the world a better place.



**Product Compliance:** CSA B45.5/IAPMO Z124  
Accessory: ASME A112.18.2/CSA B125.2



Sinks are listed by IAPMO<sup>®</sup> as meeting the applicable requirements of the Uniform Plumbing Code<sup>®</sup>, International Plumbing Code<sup>®</sup>, and National Plumbing Code of Canada.



Complies with ADA & ICC A117.1 accessibility requirements when installed according to the requirements outlined in these standards.

- [Clean and Care Manual \(PDF\)](#)
- [Installation Instructions \(PDF\) - 1000005238](#)
- [Installation Instructions \(PDF\) - 1000004396](#)
- [Installation Instructions \(PDF\) - 1000003889\\_perfect-drain](#)
- [Installation Instructions \(PDF\) - Garbage Disposer Compatibility Guide](#)
- [Warranty \(PDF\)](#)

PART: \_\_\_\_\_ QTY: \_\_\_\_\_  
 PROJECT: \_\_\_\_\_  
 CONTACT: \_\_\_\_\_  
 DATE: \_\_\_\_\_  
 NOTES: \_\_\_\_\_  
 APPROVAL: \_\_\_\_\_

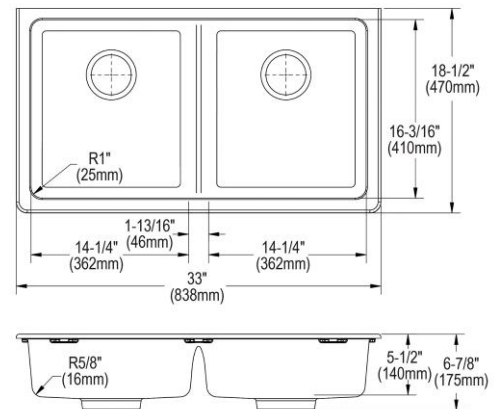





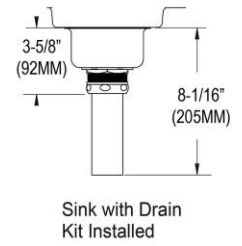
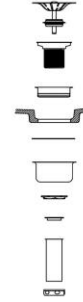
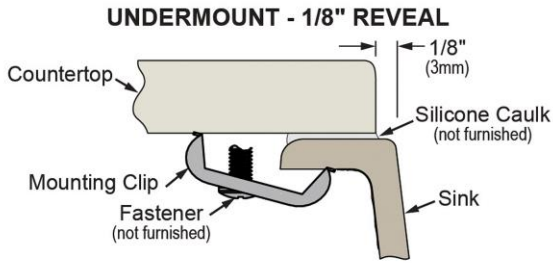

In keeping with our policy of continuing product improvement, Elkay reserves the right to change product specifications without notice. Please visit [elkay.com](#) for the most current version of Elkay product specification sheets. This specification describes an Elkay product with design, quality, and functional benefits to the user. When making a comparison of other producers' offerings, be certain these features are not overlooked.

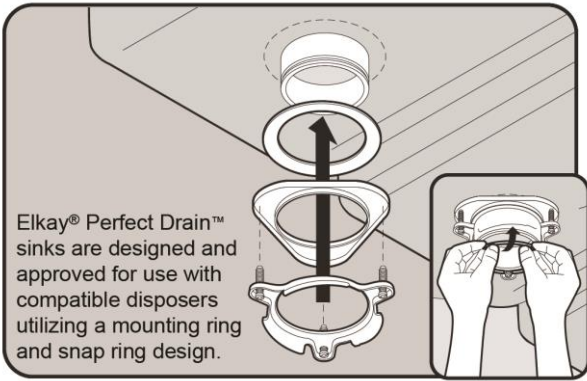
**Installation Profile:**





Designed to affix to the underside of any solid surface countertop.



Included Accessories		
<a href="#">LKPDQ1CR</a>	Elkay Perfect Drain Fitting Type 304 Stainless Steel Body and Strainer Chrome <a href="#">Spec Sheet (PDF)</a>	
Optional Accessories		
<a href="#">LKCBEG1516HW</a>	Elkay Hardwood 15-5/16" x 17-3/16" x 1" Cutting Board <a href="#">Spec Sheet (PDF)</a>	
<a href="#">LKPDQ1LS</a>	Elkay Perfect Drain Fitting Type 304 Stainless Steel Body and Strainer Lustrous Steel <a href="#">Spec Sheet (PDF)</a>	
<a href="#">LKPDQS</a>	Elkay Quartz Perfect Drain <sup>®</sup> 3-1/2" Removable Polymer Basket Strainer and Rubber Stopper <a href="#">Spec Sheet (PDF)</a>	
<a href="#">LKPDQD1</a>	Elkay Quartz Perfect Drain <sup>®</sup> 3-1/2" Polymer Disposer Flange with Removable Basket Strainer and Rubber Stopper <a href="#">Spec Sheet (PDF)</a>	

In keeping with our policy of continuing product improvement, Elkay reserves the right to change product specifications without notice. Please visit [elkay.com](http://elkay.com) for the most current version of Elkay product specification sheets. This specification describes an Elkay product with design, quality, and functional benefits to the user. When making a comparison of other producers' offerings, be certain these features are not overlooked.

<a href="#">LKGT1042</a>	<p>Elkay Gourmet Single Hole Bar Faucet Pull-out Spray and Lever Handle</p> <p><a href="#">Spec Sheet (PDF)</a></p>	<p>NO IMAGE AVAILABLE</p>
<a href="#">LKQD35</a>	<p>Elkay® Polymer 3-1/2" Disposer Flange with Removable Basket Strainer and Rubber Stopper</p> <p><a href="#">Spec Sheet (PDF)</a></p>	
<a href="#">LKQS35</a>	<p>Elkay® Polymer 3-1/2" Drain Fitting with Removable Basket Strainer and Rubber Stopper</p> <p><a href="#">Spec Sheet (PDF)</a></p>	

*In keeping with our policy of continuing product improvement, Elkay reserves the right to change product specifications without notice. Please visit [elkay.com](http://elkay.com) for the most current version of Elkay product specification sheets. This specification describes an Elkay product with design, quality, and functional benefits to the user. When making a comparison of other producers' offerings, be certain these features are not overlooked.*