



BOSCH



Register your
appliance and
join the Bosch
family of perks:
[bosch-home.com/us/
mybosch](https://bosch-home.com/us/mybosch)

Washing machine

WGB246AXUC

[en-us] User manual and installation instructions



You can find additional information and explanations online.
Scan the QR code on the title page.



Table of contents

1 Safety	4	7 Display	22
1.1 Safety definitions	4	8 Buttons	24
1.2 General information	4	9 Programs	26
1.3 Intended use	4	10 Accessories	30
1.4 Restrictive Use	5	11 Laundry	31
1.5 Grounding instructions	5	11.1 Preparing the laundry	31
1.6 Safe installation	5	12 Detergents and care products	31
1.7 Safe use	7	13 Basic Operation	31
1.8 Safe cleaning and maintenance	9	13.1 Switching on the appliance ..	31
1.9 State of California Proposition 65 Warnings	10	13.2 Setting a program	32
2 Preventing material damage	11	13.3 Saving the program settings	32
3 Environmental protection and energy-saving	12	13.4 Opening the door	32
3.1 Disposal of packaging	12	13.5 Loading laundry	33
3.2 Save energy and conserve resources	12	13.6 Starting the program	33
3.3 Energy-saving mode	12	13.7 Soaking laundry	33
4 Installation and connection	12	13.8 Adding laundry	33
4.1 Unpacking the appliance	12	13.9 Terminating the program	33
4.2 Included in delivery	13	13.10 Removing the laundry	34
4.3 Requirements for the installation location	13	13.11 Put the appliance into standby mode	34
4.4 Installation types	14	14 Control panel lock	34
4.5 Removing the transit bolts	15	14.1 Activating the control panel lock	34
4.6 Connecting the appliance	16	14.2 Deactivating the control panel lock	34
4.7 Aligning the appliance	17	15 Intelligent dosing system	34
5 Before using for the first time ..	18	15.1 Pouring liquid detergent and fabric softener into the dispensers	34
5.1 Starting an empty washing cycle	18	15.2 Using the manual dosing compartment	35
6 Familiarizing yourself with your appliance	20	15.3 Adapting the ⊗/△ dispenser	35
6.1 Appliance	20		
6.2 Detergent drawer	20		
6.3 Control panel	21		
6.4 Operating logic	21		

15.4 Setting the basic dosage amount	35	22.1 Information regarding Free and Open Source Software ..	53
16 Home Connect®	36		
16.1 Setting up Home Connect®	36		
16.2 Deactivating Wi-Fi on the appliance	36		
16.3 Activating Wi-Fi on the appliance	36		
16.4 Installing a software update	37		
16.5 Resetting the appliance network settings	37		
16.6 Remote start	37		
16.7 Remote Diagnostics	37		
16.8 Data Protection	37		
17 Basic settings	38		
17.1 Overview of the basic settings	38		
17.2 Changing the basic settings	38		
18 Cleaning and maintenance	39		
18.1 Cleaning the drum	39		
18.2 Cleaning the detergent drawer	39		
18.3 Cleaning the drain pump	41		
18.4 Cleaning the rubber gasket ..	44		
19 Troubleshooting	44		
19.1 Emergency release	50		
20 Transportation, storage and disposal	50		
20.1 Removing the appliance	50		
20.2 Inserting the transit bolts	50		
20.3 Using the appliance again	51		
20.4 Disposal of your old appliance	51		
21 Customer Service	51		
21.1 Model number (E-Nr.), production number (FD) and consecutive numbering (Z-Nr.)	52		
22 Technical specifications	52		



IMPORTANT SAFETY INSTRUCTIONS

READ AND SAVE THESE INSTRUCTIONS

Read all of the instructions carefully before using the appliance. In order to reduce the risk of fire, electric shocks and personal injuries when using the appliance, follow the basic safety precautions, including the following safety instructions.

1.1 Safety definitions

Here you can find explanations of the safety signal words used in this manual.

WARNING

This indicates that death or serious injuries may occur as a result of non-observance of this warning.

CAUTION

This indicates that minor or moderate injuries may occur as a result of non-observance of this warning.

NOTICE

This indicates that damage to the appliance or property may occur as a result of non-compliance with this advisory.

Note: This alerts you to important information.

1.2 General information



- Read this manual carefully.
- Keep the manual and the product information in a safe place for future reference or for the next owner.
- Do not connect the appliance if it has been damaged in transit.

1.3 Intended use

Only a licensed professional may connect appliances without plugs. The manufacturer is not responsible for damage caused by incorrect connections. An incorrect connection is not covered by the Statement of Limited Product Warranty.

Only use this appliance:

- For washing machine-washable fabrics and hand-washable wool in accordance with the care label.
- With tap water and commercially available, washing-machine-suitable detergents and care products.



IMPORTANT SAFETY INSTRUCTIONS

READ AND SAVE THESE INSTRUCTIONS

- in closed rooms in the home and with similar applications, e.g.: in canteens in stores, offices and other work environments; in agricultural businesses; use by customers in hotels, motels and other typical home environments; in bed and breakfasts.
- Up to an altitude of 4000 m above sea level.

1.4 Restrictive Use

This appliance is not intended for use by persons (including children) with reduced physical, sensory or mental capabilities, or lack of experience and knowledge, unless they have been given supervision or instruction concerning use of the appliance by a person responsible for their safety.

Do not let children play with the appliance.

Cleaning and user maintenance must not be performed by children unless they are being supervised.

Keep children under the age of 3 and pets away from the appliance.

1.5 Grounding instructions

This appliance must be grounded. In the event of malfunction or breakdown, grounding will reduce the risk of electric shock by providing a path of least resistance for electric current. This appliance is equipped with a cord having an equipment-grounding conductor. Installation, electrical connections and grounding must comply with all applicable codes.

WARNING

Improper connection of the equipment-grounding conductor can result in a risk of electric shock.

- ▶ Check with a qualified electrician or authorized service representative if you are in doubt whether the appliance is properly grounded.

1.6 Safe installation

WARNING

To avoid risk of injury from incorrect installations, observe the following.

- ▶ Ensure all installation instructions are followed before use.
- ▶ Connect and operate the appliance only in accordance with the specifications on the rating plate.
- ▶ Connect the appliance to a power supply with alternating current only via a correctly installed socket outlet with grounding.
- ▶ The protective conductor system of the domestic electrical installation must be properly installed. The installation must have a sufficiently large cable cross-section.



IMPORTANT SAFETY INSTRUCTIONS

READ AND SAVE THESE INSTRUCTIONS

- ▶ When using a residual current circuit breaker, only use a type with the  mark.
- ▶ Never equip the appliance with an external switching device, e.g. a timer or remote control.
- ▶ When the appliance is installed, the mains plug of the power cord must be freely accessible. If free access is not possible, an isolating switch must be integrated into the permanent electrical installation according to the installation regulations.
- ▶ When installing the appliance, check that the power cord is not trapped or damaged.

To avoid risk of injury from damaged insulation of the power cord, observe the following.

- ▶ Never let the power cord come into contact with hot appliance parts or heat sources.
- ▶ Never let the power cord come into contact with sharp points or edges.
- ▶ Never kink, crush or modify the power cord.

WARNING

To avoid risk of injury from an extended power cord and non-approved adapters, observe the following.

- ▶ Do not use extension cords or multiple socket strips.
- ▶ Only use adapters and power cords approved by the manufacturer.
- ▶ If the power cord is too short and a longer one is not available, please contact an electrician to make the necessary changes in accordance with national and local electrical codes.

WARNING

The heavy weight of the appliance may result in injury when lifted.

- ▶ Do not lift the appliance on your own.

If this appliance is not correctly installed in a washer-dryer stack, the installed appliance may fall.

- ▶ Only stack the dryer on a washing machine using the connection kit from the dryer manufacturer. No other installation method is permitted.
- ▶ Do not install the appliance in a washer-dryer stack if the dryer manufacturer does not offer a suitable connection kit.
- ▶ Do not install appliances from different manufacturers and with varying depths and widths in a washer-dryer stack.
- ▶ Do not install a washer-dryer stack on a platform; the appliances may tip over.



IMPORTANT SAFETY INSTRUCTIONS

READ AND SAVE THESE INSTRUCTIONS

WARNING

Children may pull packaging material over their heads, or wrap themselves up in it and suffocate.

- ▶ Keep packaging material away from children.
- ▶ Do not allow children to play with packaging material.

CAUTION

The appliance may vibrate or move when in use.

- ▶ Place the appliance on a clean, even, solid surface.
- ▶ Align the appliance using the appliance feet and a spirit level.

If hoses and power cords have been laid incorrectly, this causes a tripping hazard.

- ▶ Lay hoses and power cords in such a way that there is no risk of tripping.

If the appliance is moved by holding onto protruding components, such as the appliance door, the parts may break off.

- ▶ Do not move the appliance by holding onto protruding parts.

CAUTION

Touching sharp edges on the appliance may lead to cuts.

- ▶ Do not touch the sharp edges on the appliance.
- ▶ Wear protective gloves when installing and transporting the appliance.

1.7 Safe use

WARNING

To avoid risk of injury from a damaged appliance or power cord, observe the following.

- ▶ Never operate a damaged appliance.
- ▶ Never pull on the power cord to unplug the appliance. Always unplug the appliance at the power outlet.
- ▶ If the appliance or the power cord is damaged, immediately unplug the power cord or switch off the breaker in the circuit breaker box and turn off the water tap.
- ▶ Call Customer Service. → *Page 51*

Moisture intrusion may cause an electric shock.

- ▶ Use the appliance in enclosed spaces only.
- ▶ Never expose the appliance to intense heat or humidity.
- ▶ Do not use steam cleaners, high-pressure cleaners, hoses or sprays to clean the appliance.



IMPORTANT SAFETY INSTRUCTIONS

READ AND SAVE THESE INSTRUCTIONS

WARNING

Children can lock themselves in the appliance, thereby putting their lives at risk.

- ▶ The appliance must not be set up behind a lockable door, a sliding door or a door with a hinge on the side opposite to the appliance, which prevents appliance from opening fully.
- ▶ With redundant appliances, pull out the mains plug of the power cord, cut through the power cord and remove the appliance door.

When spinning larger, waterproof items of laundry, imbalances may arise and lead to injuries.

- ▶ Do not wash and spin larger items of laundry, such as blankets or mattress covers, in the appliance.

WARNING

Children may breathe in or swallow small parts, causing them to suffocate.

- ▶ Keep small parts away from children.
- ▶ Do not allow children to play with small parts.

WARNING

A hot-water system that has not been used for 2 weeks or more may produce flammable hydrogen gas.

- ▶ Before using the appliance open all hot-water faucets for a few minutes to release hydrogen gas.
- ▶ During these minutes, do not smoke or use an open flame.

WARNING

Detergents and care products may result in poisoning if consumed.

- ▶ If accidentally swallowed, seek medical advice.
- ▶ Keep detergents and care products out of the reach of children.

WARNING

Laundry that has been pretreated with flammable cleaning agents that contain solvents may cause an explosion in the appliance.

- ▶ Rinse pretreated laundry thoroughly with water before washing.

CAUTION

The covering plate may break if you stand on or climb onto the appliance.

- ▶ Do not stand on or climb onto the appliance.

The appliance may tip over if you sit on or lean against the open door.

- ▶ Do not sit on or lean against the appliance door.
- ▶ Do not place any objects on the appliance door.

Reaching into the drum while it is still turning may cause hand injuries.

- ▶ Wait for the drum to come to a complete stop before reaching inside.



IMPORTANT SAFETY INSTRUCTIONS

READ AND SAVE THESE INSTRUCTIONS

CAUTION

When you wash at high temperatures, the detergent solution becomes hot.

- ▶ Do not touch the hot detergent solution.

CAUTION

If the detergent drawer is opened, detergent and care products may spray out from the appliance.

Contact with eyes or skin may cause irritation.

- ▶ Rinse eyes and/or skin thoroughly with clean water if they come into contact with detergents or care products.
- ▶ If accidentally swallowed, seek medical advice.
- ▶ Keep detergents and care products out of the reach of children.

1.8 Safe cleaning and maintenance

WARNING

To avoid risk of injury from improper repairs, observe the following.

- ▶ Never make any technical modifications to the appliance or its features.
- ▶ Do not tamper with controls.
- ▶ Only qualified technicians or authorized service providers should perform repairs.
- ▶ Only genuine spare parts may be used to repair the appliance.
- ▶ If the power cord of this appliance becomes damaged, it must be replaced by the manufacturer, the manufacturer's Customer Service, or an authorized service provider in order to prevent injury.

Moisture entering the appliance may cause electrical shock.

- ▶ Before cleaning, pull out the power plug or switch off the circuit breaker in the circuit breaker box.
- ▶ Do not use steam cleaners, high-pressure cleaners, hoses or sprays to clean the appliance.

WARNING

To avoid risk of injury from the use of non-original spare parts and non-original accessories, observe the following.

- ▶ Use only manufacturer-approved spare parts and accessories.

WARNING

Poisonous fumes may be given off if you use cleaning agents that contain solvents.

- ▶ Do not use cleaning agents that contain solvents.



IMPORTANT SAFETY INSTRUCTIONS

READ AND SAVE THESE INSTRUCTIONS

1.9 State of California Proposition 65 Warnings

This product may contain a chemical known to the State of California, which can cause cancer or reproductive harm. Therefore, the packaging of your product may bear the following label as required by California:

STATE OF CALIFORNIA PROPOSITION 65 WARNING:

 **WARNING**

Cancer and Reproductive Harm - www.P65Warnings.ca.gov

2 Preventing material damage

NOTICE

The functionality of the appliance may be impaired if you use the wrong quantity of fabric softener, detergent, care product or cleaning agent.

- ▶ Follow the dosage recommendations from the manufacturer.
- ▶ Only use fabric softeners or products to eliminate static that are specifically recommended for this purpose by the product manufacturer.

Exceeding the maximum load capacity impairs the function of the appliance.

- ▶ Observe the maximum load capacity for each programme and do not exceed it. → *Page 26*

The appliance is secured for transportation using transport locks.

Transit bolts which have not been removed may result in material damage and damage to the appliance.

- ▶ Before starting up the appliance, remove the transit bolts completely and keep them in a safe place.
- ▶ Before transport, fit the transit bolts fully in order to prevent damage in transit.

Material damage may be caused if the water inlet hose is connected incorrectly.

- ▶ Tighten the screw connections on the water inlet until they are hand-tight.
- ▶ Connect the water inlet hose directly to the water tap, without any additional connecting elements such as adapters, extensions, or valves.
- ▶ Make sure that the valve housing for the water inlet hose does not

come into contact with its surroundings and is not subjected to any external forces.

- ▶ Ensure that the inner diameter of the water tap is at least 17 mm.
- ▶ Make sure that the length of the thread on the connection to the water tap is at least 10 mm.

To avoid damage to the appliance or property damage, observe the following.

- ▶ Do not connect the appliance to the water line during construction or if the water appears cloudy or contains visible particles. Failure to follow these instructions may result in foreign materials entering the appliance, which could impair its performance, or cause water leakage.

If the water pressure is too high or too low, this may impair functioning of the appliance.

- ▶ Make sure that the water pressure in the water supply system is at least 14.5 psi (100 kPa) and max. 145 psi (1000 kPa).
- ▶ If the water pressure exceeds the maximum value specified, a pressure-reducing valve must be installed between the drinking water connection and the hose set of the appliance.
- ▶ Do not connect the appliance to the mixer tap of an unpressurised hot-water boiler.

Modified or damaged water hoses may result in material damage and damage to the appliance.

- ▶ Never kink, crush, modify or cut through water hoses.
- ▶ Only use the water hoses supplied with the appliance or genuine spare hoses.
- ▶ Never re-use water hoses that have been used before.

Operating the appliance using water that is dirty or too hot may lead to material damage and damage to the appliance.

- ▶ Only operate the appliance with cold or warm (max. 60 °C/140 °F) mains water.

Unsuitable cleaning agents may damage the surfaces of the appliance.

- ▶ Do not use strong or abrasive cleaning agents.
- ▶ Do not use cleaning agents with a high alcohol content.
- ▶ Do not use hard scouring pads or cleaning sponges.
- ▶ Clean the appliance with nothing but water and a soft, damp cloth.
- ▶ Remove all detergent residue, spray residue or other residues immediately if they come into contact with the appliance.

3 Environmental protection and energy-saving

3.1 Disposal of packaging

The packaging materials are environmentally compatible and can be recycled.

- ▶ Sort the individual components by type and dispose of them separately.

3.2 Save energy and conserve resources

If you follow these instructions, your appliance will use less power and water.

- Choose programs with low temperatures and longer wash times and use maximum load capacity.
→ *Page 26*
- Dose detergent based on the laundry's degree of soiling.

- Reduce the washing temperature for lightly and normally soiled laundry.
- Set the maximum spin speed if you want to dry the laundry in a tumble dryer afterwards.
- Wash the laundry without prewash.

3.3 Energy-saving mode

If you do not use the appliance for a brief period, it automatically switches to energy-saving mode. All displays go out and II ▷ flashes.

Energy-saving mode ends when you use the appliance again.

If you do not use the appliance for an extended period, it automatically switches to standby mode.

4 Installation and connection

Install the appliance according to the manufacturer's instructions and local codes.

4.1 Unpacking the appliance

NOTICE

Objects remaining in the drum that are not designed for operation with the appliance may cause material damage and damage to the appliance.

- ▶ Remove these objects, along with all supplied accessories, from the drum before starting the appliance.

1. Remove any packaging and protective covers completely from the appliance. → *Page 12*
2. Check the appliance for visible damage.
3. Open the door. → *Page 32*
4. Remove any accessories from the drum.
5. Close the door.

4.2 Included in delivery

After unpacking all the parts, check for any damage in transit and for completeness of delivery.

NOTICE

If the appliance is operated with incomplete or defective accessories, the appliance may not be able to operate properly, or this may result in material damage and damage to the appliance.

- ▶ Do not operate the appliance with incomplete or defective accessories.
- ▶ Replace the accessories in question before operating the appliance.

→ "Accessories", Page 30

Note: The appliance has undergone a function test at the factory. This may cause water stains in the appliance, which the first wash cycle removes.

The delivery consists of the following:

- Washing machine
- Accompanying documents
- Transit bolts → Page 15
- Cover cap¹
- Water inlet hoses → Page 16
- Elbow for securing the water outlet hose

4.3 Requirements for the installation location

⚠ WARNING

The appliance contains live parts. Touching live parts is dangerous.

- ▶ Do not operate the appliance without a cover cap.

⚠ WARNING

When using the appliance on a base, the appliance may tip over.

- ▶ Always secure the feet of the appliance to a base using the manufacturer's fixing brackets → Page 30 before using the appliance for the first time.

NOTICE

If residual water in the appliance freezes, this may cause damage to the appliance.

- ▶ Do not install or operate this appliance anywhere that is liable to experience frost and/or outdoors.

If the appliance is tilted at an angle greater than 40°, residual water may leak out of the appliance and cause material damage.

- ▶ Tilt the appliance carefully.
- ▶ Transport the appliance in an upright position.

Installation location Requirements

Base

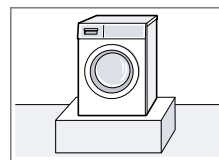

Secure the appliance with fixing brackets → Page 30.

Wooden joist floor

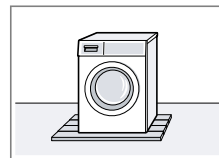

Place the appliance on a water-resistant wooden board (minimum thickness of 1.18 in. (30 mm)) which is screwed tightly to the floor.

Kitchen unit

Only install the appliance underneath a continu-

¹ The number of cover caps varies depending on the model.

Installation location Requirements

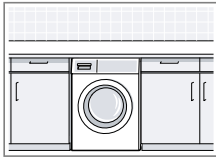

ous countertop that is securely connected to adjacent cabinets. Required niche width: 23.6 in. (60 cm).

Against a wall

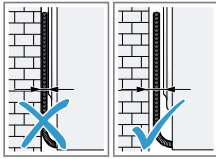

Do not trap the power cord or the hoses between the wall and the appliance.

4.4 Installation types

The appliance can be set up in a closed cabinet either in a washer-dryer stack or free-standing.

⚠ WARNING

If this appliance is not correctly installed in a washer-dryer stack, the installed appliance may fall.

- ▶ Only stack the dryer on a washing machine using the connection kit from the dryer manufacturer. No other installation method is permitted.
- ▶ Do not install the appliance in a washer-dryer stack if the dryer manufacturer does not offer a suitable connection kit.
- ▶ Do not install appliances from different manufacturers and with varying depths and widths in a washer-dryer stack.
- ▶ Do not install a washer-dryer stack on a platform; the appliances may tip over.

Installation in a closed cabinet

Notes

- In case of set up in a washer-dryer stack, please observe the requirements for the installation location.
- When installing in a cabinet, comply with the required minimum dimensions.
- To achieve shorter drying times, operate the appliance with the cabinet door open. Operating the appliance in a closed cabinet with only the minimum required ventilation openings may lead to longer drying times.

The specified dimensions of the ventilation opening apply to each position and must not be divided between the upper and lower positions.

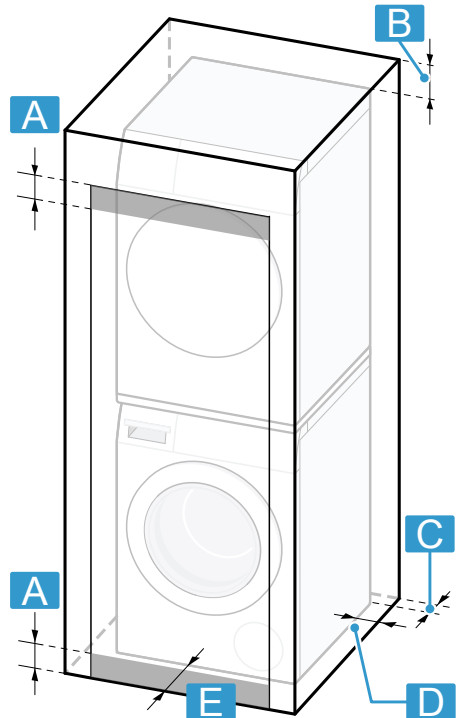

A	1.25" (3.2 cm)
B	6.25" (16.0 cm)
C	3.0" (7.5 cm)
D	0.5" (1.3 cm) ¹
E	0.5" (1.3 cm)

The specified dimensions of the ventilation openings apply to each position and must not be divided between the upper and lower positions.

Installation in an open cabinet

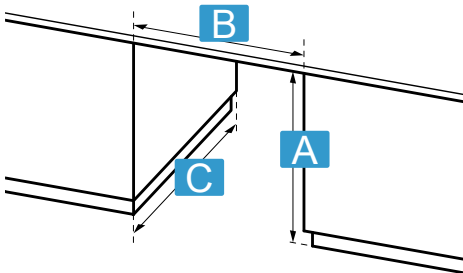

A	34.5" (87.6 cm)
B	23.8" (60.5 cm)
C	28.0" (71.1 cm)

4.5 Removing the transit bolts

The appliance is secured for transportation using transit bolts on the rear of the appliance.

Note: Keep the transit bolt screws and the sleeves in a safe place for future transport.

1. Remove the hose ① and the power cord ② from the holders.

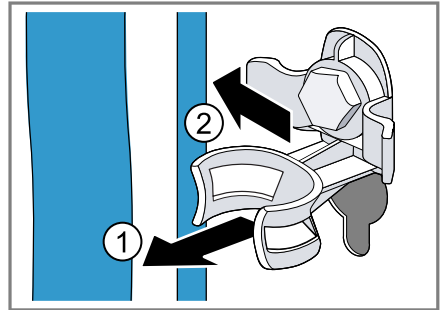

2. Unscrew ① and remove ② all of the screws for the 4 transit bolts using a 13 mm wrench.

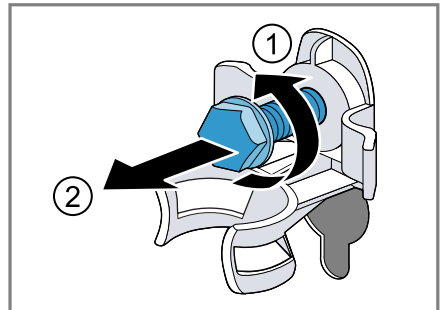

3. Remove the 4 sleeves.

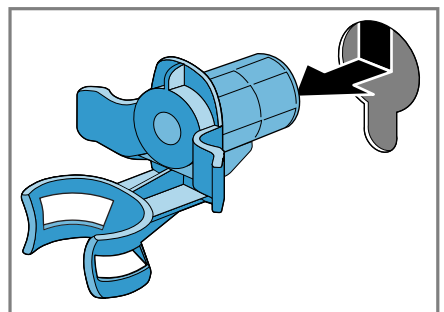

4. Insert the cover cap and push it downwards.

¹ Valid for both sides of the appliance

Notes

- Note the number of cover caps included in the scope of delivery
- If four cover caps are included in the scope of delivery, insert the cover caps in the four openings for the transit bolts.

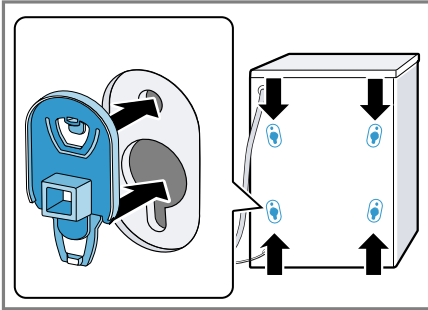

- If one cover cap is included in the scope of delivery, insert the cover cap in the bottom left opening for the transit bolt.

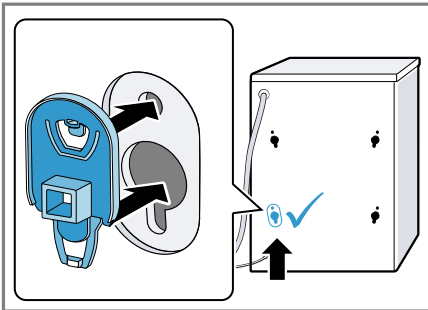

Note: To install the transport locks to transport the appliance, perform these steps again in the reverse order.

4.6 Connecting the appliance

Connecting the water inlet hoses

NOTICE

Material damage may be caused if the water inlet hose is connected incorrectly.

- ▶ Tighten the screw connections on the water inlet until they are hand-tight.

1. Connect the water inlet hose for hot water a (red) and cold water b (blue) to the appliance.

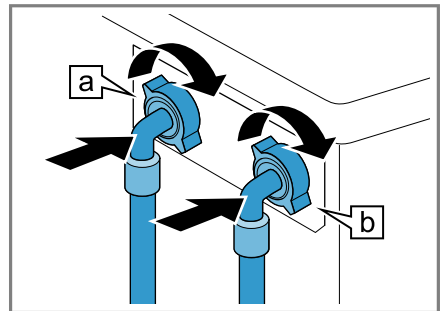

2. Connect the water inlet hose for hot water a (red) and cold water b (blue) to the faucet (26.4 mm = 3/4").

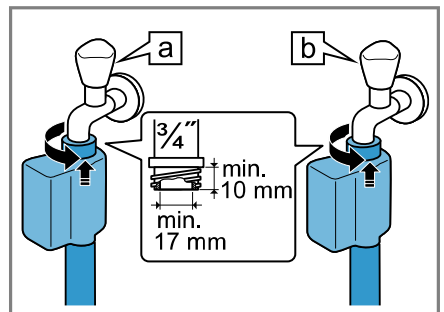

If there is no faucet for hot water, only connect the water inlet hose for cold water. Cover the hot water connection on the appliance in order to protect it from dirt.

Tip: To protect against dirt, use a 3/4" end cap on the hot water connection of the appliance.

3. Open the faucets carefully and check that the connection points are tight.

Water outlet connection types

This information is intended to help you to connect this appliance to the water outlet.

NOTICE

When draining, the water drain hose is subject to water pressure and may come loose from the installed connection point.

- ▶ Secure the water drain hose against unintentional loosening. In the event of a blocked or covered outlet, accumulated wastewater can flow back into the appliance.
- ▶ Before operating the appliance, ensure that the wastewater drains away quickly and eliminate any blockages.

Note: To avoid exceeding the maximum draining height of the appliance, do not lay the water drain hose higher than 100 cm above the installation surface of the appliance at any point.

Siphon

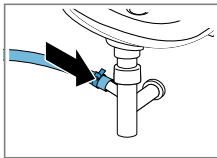

Secure the connection point with a (0.94–1.57 in. (24–40 mm)) hose clamp.

Washbasin

Fix and secure the water outlet hose with an elbow.

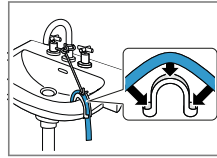

Plastic pipe with rubber sleeve or gully

Fix and secure the water drain hose with an elbow.

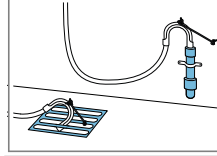

Connecting the appliance to the electricity supply

Note: Your electrical domestic installation for this appliance must comply with the local legal provisions and safety regulations, and should include a residual current circuit breaker.

1. Insert the power adapter with the line side into a suitable socket close to the appliance. Observe the user manual that is enclosed with the power adapter.
2. Insert the power plug of the appliance's power cord in a socket outlet with grounding nearby. The connection details of the appliance can be found under Technical data → *Page 52*.
3. Check the power plug is inserted properly.

4.7 Aligning the appliance

In order to reduce noise and vibrations, and to prevent the appliance from moving, align the appliance correctly.

en-us Before using for the first time

1. Use a 17 mm wrench to loosen the lock nuts in a clockwise direction.

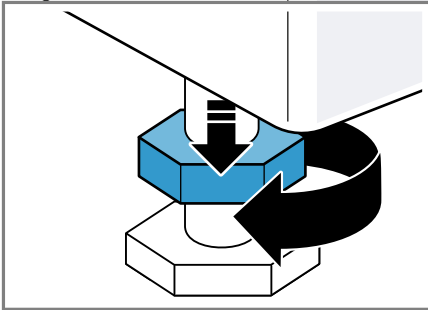

2. To align the appliance, turn the appliance feet. Check that the appliance is level using a spirit level.

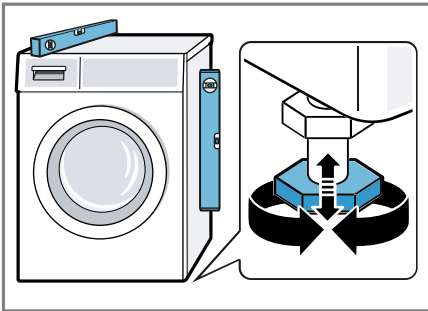

All appliance feet must stand firmly on the ground.

3. Use a 17 mm wrench to tighten the lock nuts against the housing until they are hand-tight.

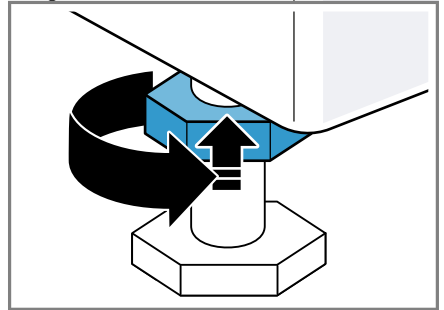

In doing so, hold the appliance foot tight and do not adjust its height.

5 Before using for the first time

Prepare the appliance for use.

5.1 Starting an empty washing cycle

Your appliance was inspected thoroughly before leaving the factory. To remove any residual water, run the first wash cycle without any laundry.

1. Press .
The switch-on process takes a few seconds.
2. Set the **Drum Clean** program.
3. Close the door.
4. Pull out the detergent drawer.

5. Pour approximately 4.3 cups (1 liter) of mains water into the manual dosing compartment.

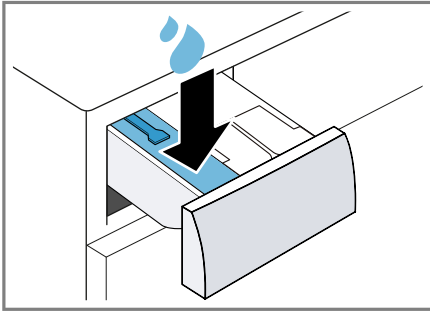

6. Add washing powder containing oxygen bleach to the manual dosing compartment.

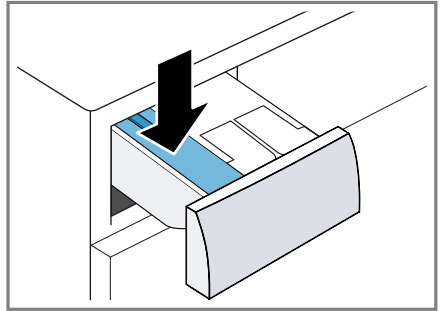

To prevent foaming, use only half of the amount of detergent recommended by the detergent manufacturer for light soiling. Do not use detergent suitable for woolens or delicates.

7. Push in the detergent drawer.
8. Start the program. → *Page 33*
9. Start the first wash cycle or press ϕ to put the appliance in standby mode.

→ *"Basic Operation", Page 31*

6 Familiarizing yourself with your appliance

6.1 Appliance

Here you can find an overview of the parts of your appliance.

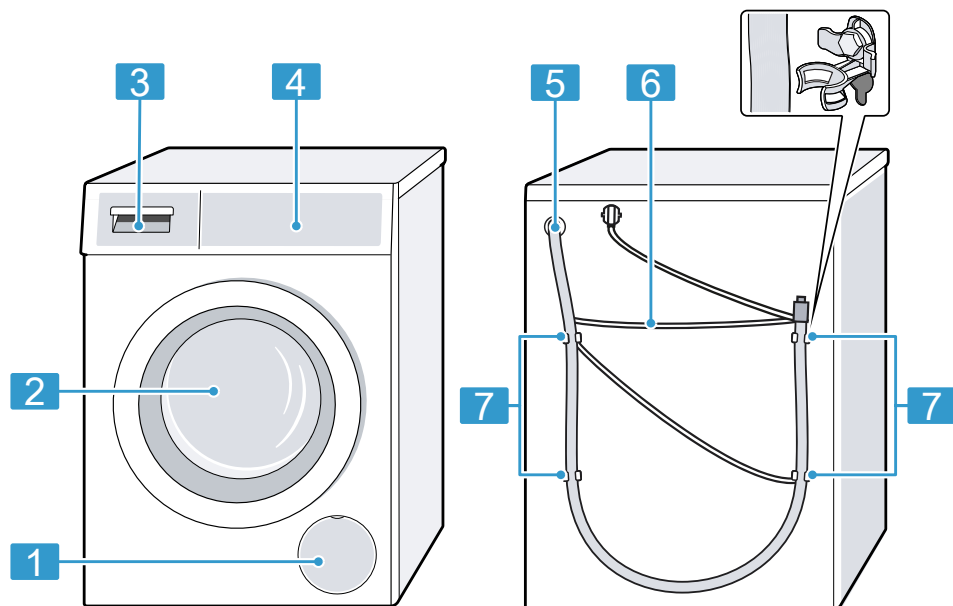

On certain models, specific details such as the color and shape may differ from those pictured.

1 Maintenance flap for the drain pump → *Page 41*

2 Door → *Page 32*

3 Detergent drawer → *Page 20*

4 Control panel → *Page 21*

5 Water drain hose → *Page 17*

6 Power cord → *Page 17*

7 Transit bolts → *Page 15*

6.2 Detergent drawer

Note: Observe the manufacturer's instructions on the use and dosage of the detergent and care product and

the information in the program descriptions.

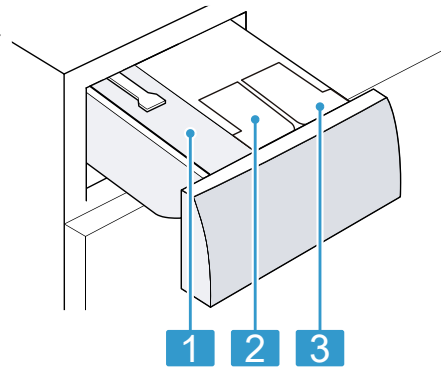

-
- 1** Manual dosing compartment
→ "Using the manual dosing compartment", Page 35
-
- 2** ⌘ / ∅ : Dispenser for fabric softener or liquid detergent
→ "Intelligent dosing system", Page 34
-
- 3** ∅ : Dispenser for liquid detergent
→ "Intelligent dosing system", Page 34
-

6.3 Control panel

You can use the control panel to configure all functions of your appliance and to obtain information about the operating status.

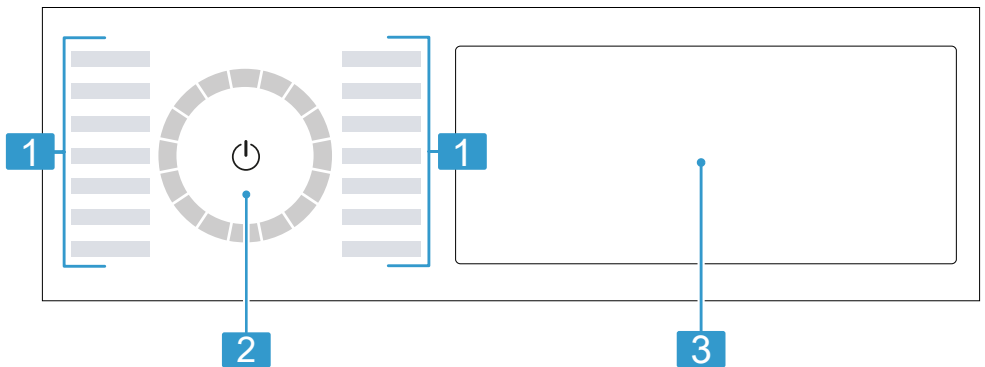

-
- 1** Programs → Page 26
-
- 2** Program selector → Page 31
-
- 3** Buttons → Page 24 and display → Page 22
-

6.4 Operating logic

Some areas of the display are buttons and respond to touch. You can activate, deactivate or change settings by pressing the buttons. The activated settings are highlighted brightly on the display.

NOTICE

Pressing on the display with force may cause damage.

- ▶ Do not apply heavy pressure on the display.
- ▶ Do not press on the display using pointed or sharp objects.

Displaying or hiding additional buttons

Some buttons are hidden for a reduced display. If you display these additional buttons on the display, you can activate or deactivate the corresponding settings.

1. To display the additional buttons, briefly press **More**.

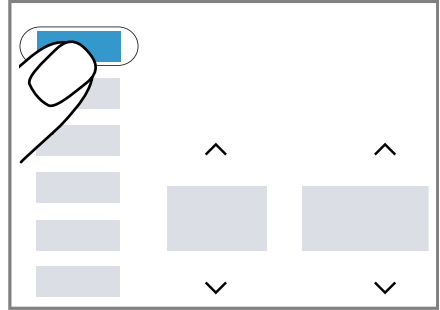

- ✓ The display shows all additional buttons.

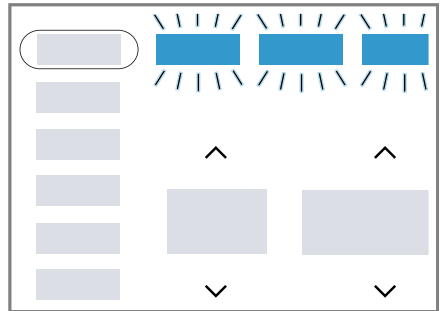

2. To hide the additional buttons, briefly press **More** again.

Changing a setting value

If you activate certain settings, the display shows selection buttons and you can change the setting value.

- ▶ Press the selection buttons
→ *Page 25*.
The display shows the setting value.

7 Display

The display shows the current settings, options or relevant information. Depending on the program status, the display shows some information in the **BB:BB** area, e.g. **E n d**.

Note: Additional functions may be available as a result of software updates.
→ *Page 37*



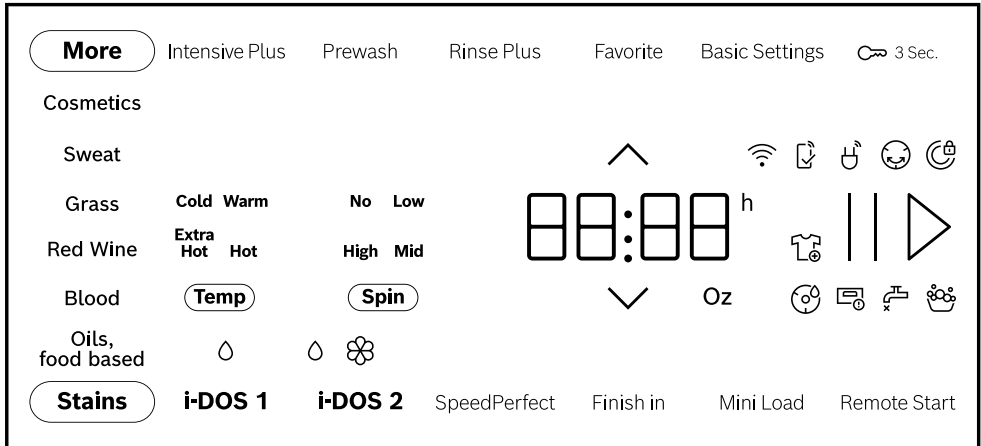











If a software update is available, you can find further information in the Home Connect® app.



Example: Display

Display	Description
0:40 ¹	Expected program duration or program time remaining in hours and minutes.
10 h ¹	Program end time → <i>Page 25</i>
No (Spin) - High	Set spin speed. → <i>Page 25</i> No (Spin): No spin cycle, draining only
Cold - Extra Hot	Set temperature. → <i>"Buttons", Page 25</i>
End	Program status: Program end
	Program status: Crease-reduction function
	<ul style="list-style-type: none"> ■ Lights up: The control panel lock is activated. ■ Flashes: The control panel lock is activated and the appliance has been operated.
	You can remove or add laundry, and interrupt the current program. → <i>Page 33</i>
Blood	The "Blood" stain type is activated.
Grass	The "Grass" stain type is activated.
Cosmetics	The "Cosmetics" stain type is activated.
Red Wine	The "Red wine" stain type is activated.
Sweat	The "Sweat" stain type is activated.
Oils, food based	The "Cooking fat/cooking oil" stain type is activated.

¹ Example

Display	Description
	Flashes: Drum cleaning is required. Run the Drum Clean program for cleaning and caring for the drum and the outer tub. → <i>Page 39</i>
	Remote start is activated. → <i>Page 26</i>
	<ul style="list-style-type: none"> ▪ Lights up: The appliance is connected to your home network via Wi-Fi. ▪ Flashes: The appliance is trying to connect to your home network via Wi-Fi.
	The appliance is connected to the smart energy system (energy manager).
	<ul style="list-style-type: none"> ▪ Lights up: The intelligent dosing system for  liquid detergent is activated. ▪ Flashes: The fill level of the dispenser is below the minimum level. → <i>Page 34</i>
 	<ul style="list-style-type: none"> ▪ Lights up: The intelligent dosing system for  liquid detergent or  fabric softener is activated. ▪ Flashes: The fill level of the dispenser is below the minimum level. → <i>Page 34</i>
1.5 Oz ¹	Basic dosage for detergent or fabric softener. → <i>Page 35</i>
	The appliance has detected too much foam. → <i>Page 47</i>
	<ul style="list-style-type: none"> ▪ Lights up: The door is locked. <ul style="list-style-type: none"> – To add laundry, the door can be unlocked if  lights up. → <i>Page 33</i> – To open the door, you can cancel the program. → <i>Page 33</i> ▪ Flashes: The door is not closed.
	<ul style="list-style-type: none"> ▪ No water pressure. → <i>Page 46</i> ▪ The water pressure from the tap is too low.
	The detergent drawer has not been pushed in fully. → <i>Page 47</i>
E:35 ¹	Error code, error display, signal. → <i>Page 44</i>

8 Buttons

Notes

- Additional functions may be available as a result of software updates. → *Page 37*

¹ Example



If a software update is available, you can find further information in the Home Connect® app.

- You can find additional functions or settings in the Home Connect® app. You can change some settings using the Home Connect® app.

Some buttons are hidden for a reduced display. You can display these additional buttons on the display. → *Page 22*

The selection of program settings depends on the program that is set.

Button	Description
II ▷ (Start/Pause Reload)	Start, cancel or pause the program. If II is displayed, you can pause the program. If ▷ is displayed, you can start the program.
∧ ∨	Change the settings. → <i>Page 21</i>
SpeedPerfect	Activate or deactivate a shorter program duration. Note: Energy consumption increases. The washing result is not affected by this.
Intensive Plus	Extend the program duration by 30 minutes for heavily soiled laundry.
Stains	Select the type of stain. The temperature, drum movement and soaking time are all adjusted to suit the type of stain.
i-DOS 1	Briefly press the button to activate or deactivate the intelligent dosing system for liquid detergent ∅ . Press and hold the button for approximately 3 seconds to set the basic dosage. → <i>Page 35</i>
i-DOS 2	Briefly press the button to activate or deactivate the intelligent dosing system for fabric softener ⊗ or liquid detergent ∅ . Press the button for approximately 3 seconds to adapt the contents of the ⊗/∅ dispenser or set the basic dosage. → <i>Page 34</i>
Finish in	Set the program end time. The program duration is already included in the set number of hours. Once the program has started, the program duration is displayed.
Temp	Adjust the temperature.
Spin	Adjust the spin speed or deactivate the spin cycle. If No (Spin) is selected, the water is drained and the spin cycle is deactivated. The laundry stays wet inside the drum.
⏻	Switch on the appliance or put it in standby mode.

Button	Description
	If the control panel does not respond, press and hold  for approximately 5 seconds to restart the appliance. → <i>Page 47</i>
Remote Start	If you press the button briefly, you can activate or deactivate remote start. → <i>Page 37</i> If you press and hold the button for approximately 3 seconds, the Home Connect® settings open. → <i>Page 36</i>
 3 sec.	Activate or deactivate the control panel lock. → <i>Page 34</i>
Basic Settings	Call up the basic settings. → <i>Page 38</i>
More	Display or hide additional buttons. → <i>Page 22</i>
Mini Load	Wash small loads of delicate or hard-wearing fabrics. The program duration is shortened, the water and energy consumption adjusted, and the maximum load capacity reduced to 1.1 lbs (0.5 kg).
Prewash	Activate or deactivate prewash, e.g., for washing heavily soiled laundry. Note: If the intelligent dosing system is activated, the detergent will be dispensed automatically for the prewash and the main wash. If the intelligent dosing system is deactivated, place the detergent directly in the drum for the prewash and into the manual dosing compartment for the main wash. → <i>Page 20</i>
Rinse Plus	Activate or deactivate an additional rinse cycle. Recommended for particularly sensitive skin or in regions with very soft water.
Favorite	Press the button for approximately 3 seconds to save your customized program settings. → <i>Page 32</i> If you briefly press the button, you set your saved program with individual program settings.

9 Programs

Notes

- The laundry's care labels provide you with additional information on program selection.
- The program's temperature setting guarantees that the recommended temperature on the care label is not exceeded. The temperature that is reached in the appliance may differ from the set temperature. This means that the best possible washing performance is achieved with optimal energy efficiency.

- Additional functions may be available as a result of software updates.

→ *Page 37*

If a software update is available, you can find further information in the Home Connect® app.

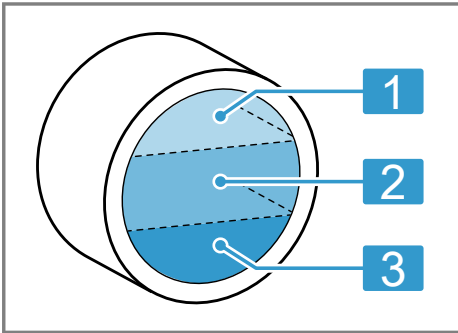

Program	Description	Max. load
Cotton	<p>Wash hard-wearing items made from cotton or linen.</p> <p>Suitable for normally soiled laundry.</p> <p>Also suitable as a short program for normally soiled laundry when you activate SpeedPerfect.</p> <p>Program setting:</p> <ul style="list-style-type: none"> Max. temperature: Extra Hot Max. spin speed: High 	large mediu m ¹
Whites	<p>Wash white hard-wearing items made from cotton or linen.</p> <p>Suitable for heavily to lightly soiled laundry.</p> <p>Program setting:</p> <ul style="list-style-type: none"> Max. temperature: Extra Hot Max. spin speed: High 	large
Mix	<p>Wash items made from cotton, linen, or synthetic fabrics.</p> <p>Suitable for lightly soiled laundry.</p> <p>Program setting:</p> <ul style="list-style-type: none"> Max. temperature: Extra Hot Max. spin speed: High 	mediu um
Sanitize	<p>Wash hard-wearing items made from cotton or linen.</p> <p>Wash with more water and at a defined temperature.</p>	mediu um

¹ **SpeedPerfect** activated

Program	Description	Max. load
	<p>Suitable for allergy-sufferers and for strict hygiene requirements.</p> <p>Program setting:</p> <ul style="list-style-type: none"> ■ Temperature: Extra Hot ■ Max. spin speed: High 	
Delicates	<p>Wash delicate, washable items made from silk, viscose, or synthetic fabrics.</p> <p>Use a detergent that is suitable for delicates or silk.</p> <p>Note: Wash especially delicate items or items with hooks, eyelets or clips in a mesh laundry bag.</p> <p>Tip: Gently cleaning the laundry reduces abrasion of textile fibers and microplastic fibers.</p> <p>Program setting:</p> <ul style="list-style-type: none"> ■ Max. temperature: Hot ■ Max. spin speed: Mid 	small
Hand Wash/ Wool	<p>Wash hand- or machine-washable items that are made from wool or contain wool.</p> <p>To prevent the laundry from shrinking, the drum moves the items very gently with long pauses.</p> <p>Use a detergent that is suitable for wool.</p> <p>Program setting:</p> <ul style="list-style-type: none"> ■ Max. temperature: Hot ■ Max. spin speed: Mid 	small
Rinse	<p>Rinses and then spins the laundry, and then drains the water.</p> <p>Program setting: Max. spin speed: High</p>	–
Spin/Drain	<p>Spins the laundry and drains the water.</p> <p>If you only want to drain the water, activate No (Spin). The laundry is not spun.</p> <p>Program setting: Max. spin speed: High</p>	–
📱 App Programs	<p>Select additional programs directly via the Home Connect® app.</p> <p>A description of the programs can be found in the Home Connect® app.</p> <p>Note: Your appliance must be connected to your home network and registered in your Home Connect® app. → <i>Page 36</i></p>	–
Towels	<p>Wash hard-wearing items made from cotton, e.g. towels and bathrobes.</p>	medium

Program	Description	Max. load
Automatic	Program setting: <ul style="list-style-type: none"> ■ Max. temperature: Extra Hot ■ Max. spin speed: High 	medium
Bedding	Wash pillows or quilts stuffed with synthetic fibers, or down fillings. Wash large items separately. Use a detergent that is suitable for down or delicates. Use sparingly. Do not use fabric softener. Note: To prevent excessive foaming, remove air from laundry items by rolling them up before you wash them. Program setting: <ul style="list-style-type: none"> ■ Max. temperature: Extra Hot ■ Max. spin speed: High 	small
Jeans	Wash dark-colored and color-intense items made from cotton or permanent press fabric, e.g. jeans. Turn laundry inside-out before washing. Use liquid detergent. Program setting: <ul style="list-style-type: none"> ■ Max. temperature: Hot ■ Max. spin speed: High 	medium
Drum Clean	Clean and care for the drum. → <i>Page 39</i> Use this program in the following cases: <ul style="list-style-type: none"> ■ Before using the appliance for the first time ■ If you regularly wash at temperatures of Hot or lower ■ After an extended period of non-use 	– ¹

¹ Washing not possible

Program	Description	Max. load
	<p>Use washing powder containing oxygen bleach. Add washing powder containing oxygen bleach to the manual dosing compartment. → <i>Page 20</i></p> <p>Halve the amount of detergent to avoid foaming. Do not use fabric softener. Do not use liquid detergent or detergent that is intended for woolens or delicates.</p> <p>Note: The drum cleaning indicator flashes to remind you if you have not used a program at temperature of Extra Hot for a long time.</p>	
SuperQuick 15/30	<p>Wash items made from cotton or synthetic fabrics. Short program for small items of lightly soiled laundry.</p> <p>Note: To adjust the program duration, activate or deactivate SpeedPerfect.</p> <p>Program setting:</p> <ul style="list-style-type: none"> ▪ Max. temperature: Hot ▪ Max. spin speed: High 	medium small ¹

10 Accessories

Only use genuine accessories. These are designed especially for your appliance.

Tip: Some accessories are available in other colors. Contact customer service. → *Page 51*

	Use	Order number
Water inlet hose extension	Extend the water inlet hose for cold water or Aquastop (approx. 2.50 m / 98,4 in).	WMZ2381
Fixing brackets	Improves the stability of the appliance.	WMZ2200
Platform	Install the appliance at a raised height so that it can be easily loaded and unloaded.	WMZPW5XW
Power adapter	Connect the appliance to a NEMA 14-30 (4-pin) outlet.	WTZPA20UC
Power adapter	Connect the appliance to a NEMA 10-30 (3-pin) outlet.	WTZPA30US

¹ **SpeedPerfect** activated

11 Laundry

11.1 Preparing the laundry

NOTICE

Objects remaining in the laundry may damage the laundry and the drum.

- ▶ Remove all items from any pockets in your laundry before using the appliance.

Note

The appliance and fabrics are protected when you prepare your laundry.

- Brush off sand and soil
- Sort the laundry according to color and fabrics and observe the care labels
- Close all zippers, hook and loop fasteners, hooks and eyes
- Tie cloth belts, cloth straps and cords together
- Remove curtain fittings and lead strips
- Wash small or particularly delicate items in a mesh washing bag
- Wash large and small items of laundry together
- Wash laundry with fresh stains immediately
- Pretreat laundry with dried stains and wash several times
- Load the laundry unfolded into the drum
- Before loading the drum, any laundry that has been pre-treated with chlorine bleach should be rinsed several times

12 Detergents and care products

You can protect your appliance and your laundry by selecting and using

the correct detergents and care products.

The manufacturer's instructions for use and dosage can be found on the packaging.

Notes

- when using liquid detergents, only use liquid detergents that are self-flowing
- Do not mix different liquid detergents
- Do not mix detergent and fabric softener
- Do not use products that have expired or are highly congealed
- do not use products containing solvents, caustic agents or volatile substances
- Do not use chlorine bleach
- Do not use dyes regularly as fixing salt can damage stainless steel
- Only use color and dirt catcher sheets in a laundry net
- Do not use color-bleaching agents in the appliance
- Do not pour vinegar into the dispensers → *Page 34* of the intelligent dosing system

13 Basic Operation

13.1 Switching on the appliance

Note: If you switch the appliance on the first time after you have connected it to the electrical system, the switch-on process takes up to one minute.

Requirement: The appliance has been correctly installed and connected. → *Page 12*

en-us Basic Operation

- ▶ Press **⏻**.
The switch-on process takes a few seconds.
- ✓ An audible function test is carried out.

Note: The lighting for the drum goes out automatically.

13.2 Setting a program

1. Press the required program.
→ *Page 26*

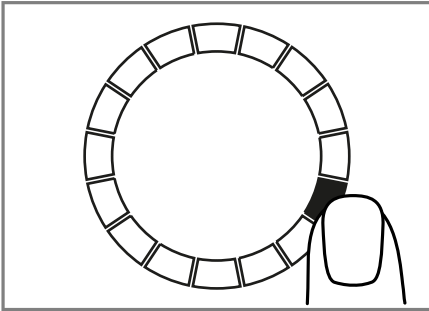

- ✓ The display shows the program settings.
2. If required, adjust the program settings. → *Page 24*
Observe the information about operating logic → *Page 21*.
The program settings are not saved permanently for the program.

Note: The setting is saved if you activate or deactivate the intelligent dosing system.

Setting additional programs

Requirement: Home Connect® is set up. → *Page 36*

1. Set the **App Programs** program.
 - ✓ **Remote Start** flashes.
2. Press **Remote Start**.
- ✓ The Home Connect® app displays the programs that can be selected.
3. Set a program in the Home Connect® app.

4. If required, adjust the program settings. → *Page 24*
5. Start the program. → *Page 33*

13.3 Saving the program settings

You can save your individual program settings as favorites.

Requirement: A program has been set. → *Page 32*

- ▶ Press and hold **Favorite** for approximately 3 seconds.
Press **Favorite** to call up the saved program.

Note: To overwrite the saved program, repeat the steps above.

13.4 Opening the door

1. Grip under the door handle and pull on the door.

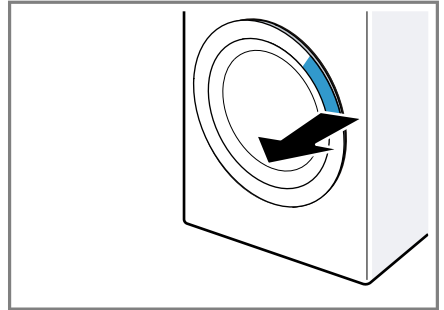

2. Open the door.

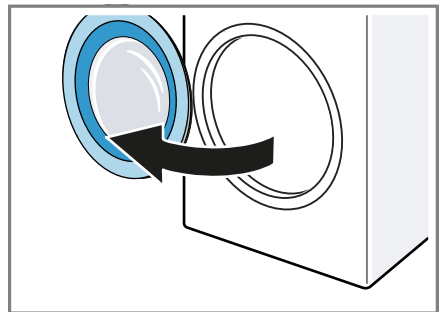

13.5 Loading laundry

Note: To prevent creasing, note the maximum load for the programs.

→ *Page 26*

Requirements

- The laundry is prepared and sorted. → *Page 31*
 - The drum is empty.
1. Open the door. → *Page 32*
 2. Place the laundry in the drum.
 3. Close the door.
Ensure that there is no laundry trapped in the door.

13.6 Starting the program

Note: If you use the intelligent dosing system, ensure that you fill the dispensers, set the basic dosage, and push the detergent drawer all the way in. → *Page 34*

Requirements

- A program has been set.
→ *Page 32*
- The door is closed.
- ▶ Press II ▷.
- ✓ The drum rotates and load detection takes place. This can take up to 2 minutes, after which water enters the drum.
- ✓ The display shows the program duration or the program end time.
- ✓ After the program has ended, the display shows: **End**.

Note: If you do not remove the laundry once the program has ended, the crease-reduction function starts after 15 minutes and takes approximately 30 minutes. The display shows ☺ and a notification to cancel the program.

Press a button on the display to cancel the crease-reduction program and to remove the laundry.

13.7 Soaking laundry

Note: No additional detergent is required for soaking. The appliance uses the filled detergent for soaking and washing.

Requirements

- The laundry is placed in the appliance. → *Page 33*
 - A program has started.
→ *Page 33*
1. Press II ▷ approx. 10 minutes after the program start.
The program pauses and the laundry can soak.
 2. Press II ▷ after the required soaking time.

13.8 Adding laundry

After the program starts, you can remove or add laundry depending on the program status.

1. Press II ▷.
The appliance pauses.
Note: If you want to add laundry, follow the instructions on the display. → *Page 23*
2. Open the door. → *Page 32*
3. Add or remove laundry.
4. Close the door.
5. Start the program. → *Page 33*

13.9 Terminating the program

1. Press II ▷.
2. Open the door. → *Page 32*
The appliance door remains locked for safety reasons if the temperature and water levels are high.
 - If the temperature is high, start the **Rinse** program.
 - If the water level is high, start the **Spin** program or select a suitable program for draining.
→ *Page 26*
3. Remove the laundry. → *Page 34*

13.10 Removing the laundry

1. Open the door. → *Page 32*
2. Remove the laundry from the drum.

13.11 Put the appliance into standby mode



1. Press .
2. Turn off the tap.
3. Cleaning the rubber gasket.
→ *Page 44*

Note: Leave the appliance door and the detergent drawer open to dry.

14 Control panel lock



Secure your appliance against being operated unintentionally using the controls.

14.1 Activating the control panel lock

- ▶ Press and hold  **3 sec.** for around 3 seconds.
- ✓ The display shows .
- ✓ The control elements are locked.
- ✓ The control panel lock also remains activated when the appliance is in standby mode and in the event of a power failure.

14.2 Deactivating the control panel lock

Requirement: To deactivate the control panel lock, the appliance must be switched on.

- ▶ Press and hold  **3 sec.** for around 3 seconds.
- ✓  goes out on the display.

15 Intelligent dosing system



The appliance's intelligent dosing system is activated at the factory and automatically doses liquid detergent and fabric softener for any programs in which intelligent dosing is possible.

Note: You can use the buttons → *Page 24* to deactivate the intelligent dosing system, e.g. in order to manually dose washing powder → *Page 35*.

15.1 Pouring liquid detergent and fabric softener into the dispensers

If you are using the intelligent dosing system or if the appliance displays a notification during operation of the appliance, fill the dispensers.

Notes

- Only pour suitable liquid detergent and fabric softener into the dispensers. → *Page 31*
 - If you add more liquid detergent or fabric softener to the dispenser, use the same product.
 - If you want to replace the liquid detergent or fabric softener in the dispenser with another product, clean the detergent drawer beforehand → *Page 39*.
 - If you are using the intelligent dosing system, do not add additional detergent or fabric softener into the compartment for manual dosing. This is to prevent overdosing or foam formation.
1. Pull out the detergent drawer.
 2. Open the lid and pour liquid detergent  and fabric softener 

into the relevant dispensers
→ *Page 20*.

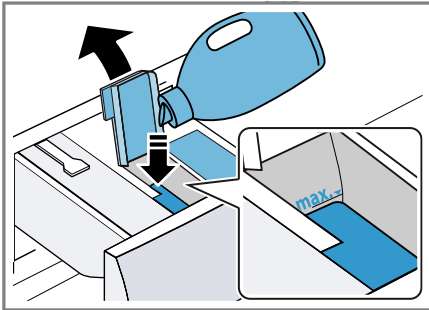

Do not exceed the marking for the maximum fill level when filling.

Note: You can also use both dispensers for liquid detergent. Adapt the dispenser for this. → *Page 35*

3. Close the lid.

Note: To prevent the liquid detergent or fabric softener from drying out, close the lids immediately after filling.

4. Push in the detergent drawer.

15.2 Using the manual dosing compartment

If you are not using the intelligent dosing system, if intelligent dosing is not possible for a program, or if you want to add additional care product, e.g. stain remover or starch, use the manual dosing compartment.

Note: Observe the information about detergents and care products
→ *Page 31*.

1. Pull out the detergent drawer.
2. Pour laundry detergent or care product into the manual dosing compartment → *Page 20*.
3. Push in the detergent drawer.

15.3 Adapting the \otimes/\circ dispenser

The \otimes/\circ dispenser can dose fabric softener \otimes or liquid detergent \circ . When it leaves the factory, the dispenser is set for fabric softener. If you want to automatically dose a second liquid detergent, adapt the dispenser.

Notes

- If you adapt the contents of the dispenser, the basic dosage for this dispenser is reset.
- If you use both dispensers for liquid detergent, you must set a dispenser which is to be used during washing. → *Page 24*

1. Press and hold **i-DOS 2** for approximately 3 seconds.
2. Press **i-DOS 2** repeatedly until the display shows \circ (liquid detergent) or \otimes (fabric softener).
3. Wait briefly to save the setting.

15.4 Setting the basic dosage amount

To allow for intelligent dosing, set the basic dosage amount for the dispenser. The basic dosage amount corresponds to the dosage recommendation from the detergent manufacturer on the packaging. Set the basic dosage amount that corresponds to the dosage recommendation for 11 lbs (5 kg) of normally soiled laundry.

Tip: You can also set the basic dosage amount in the Home Connect® app.

1. Press and hold **i-DOS 1** for approximately 3 seconds.
- ✓ The display shows the set basic dosage amount.

2. To adjust the setting, press \wedge/\vee .
3. Wait briefly to save the setting.

Note: To set the basic dosage amount for the other dispenser, repeat the steps with **i-DOS 2**.

16 Home Connect®

This appliance is network-capable. Connecting your appliance to a mobile device lets you control its functions via the Home Connect® app, adjust its basic settings and monitor its operating status.

The Home Connect® services are not available in every country. The availability of the Home Connect® function depends on the availability of the Home Connect® services in your country. You can find information on this at: www.home-connect.com.

The Home Connect® app guides you through the entire registration process. Follow the instructions, noting the information in the Home Connect® app.

Notes

- Note the safety information in this instruction manual and ensure that it is also observed when operating the appliance using the Home Connect® app.
→ "Safety", Page 4
- Operating the appliance on the appliance itself always takes priority. It is not possible to operate the appliance using the Home Connect® app during this time.

16.1 Setting up Home Connect®

Requirement: The appliance receives signals from the WLAN home network (Wi-Fi) at its installation location.

1. Scan the following QR code.



You can install the Home Connect® app and connect your appliance via the QR code.

2. Follow the instructions in the Home Connect® app.

16.2 Deactivating Wi-Fi on the appliance

1. Press and hold **Remote Start** for around 3 seconds.
2. Press **Remote Start** repeatedly until the display shows "on".
3. Press **II ▷** to deactivate the Wi-Fi.
✓ The display shows "oFF".

Note: To exit the Home Connect® settings, press and hold **Remote Start** for approx. 3 seconds.

16.3 Activating Wi-Fi on the appliance

1. Press and hold **Remote Start** for around 3 seconds.
2. Press **Remote Start** repeatedly until the display shows "oFF".
3. Press **II ▷** to activate the Wi-Fi.
✓ The display shows "on".

Notes

- If the Wi-Fi is activated, the display alternately shows "on" and the sig-

nal strength of the Wi-Fi connection.

- To exit the Home Connect® settings, press and hold **Remote Start** for approx. 3 seconds.

16.4 Installing a software update

Note: If a software update is available, a message appears in the Home Connect® app.

- ▶ To install the software update, follow the instructions in the Home Connect® app.
- ✓ The control panel is partially locked during the installation.
- ✓ In the event of a malfunction, installation may take up to 40 minutes. Do not reset the network settings or the appliance to the factory settings.

Note: You can find the current software version in the Home Connect® app under the appliance information for the appliance.

16.5 Resetting the appliance network settings

1. Press and hold **Remote Start** for around 3 seconds.
 2. Press **Remote Start** repeatedly until the display shows "rES".
 3. Press and hold II ▶ for around 3 seconds.
- ✓ The network settings are reset.

16.6 Remote start

Enable the appliance for remote start via the Home Connect® app.

Note

Remote start will be deactivated in the following circumstances:

- The appliance door is opened.
- Press **Remote Start**.
- Following a power failure.

Activating remote start

Requirements

- The appliance door is closed.
- The detergent drawer has been pushed in.
- ▶ Press **Remote Start**.
- ✓  lights up and the appliance is enabled for remote start via the Home Connect® app.

Deactivating remote start

- ▶ Press **Remote Start**.
- ✓  goes out.

16.7 Remote Diagnostics

Customer Service can access your appliance via Remote Diagnostics if you ask them to do so, provided your appliance is connected to the Home Connect® server and Remote Diagnostics is available for your appliance and country. For more information on Remote Diagnostics' availability in your country, visit the Service/Support section of your local website: www.home-connect.com.

Please be aware that while Remote Diagnostics can assist in troubleshooting select issues, there may be instances where an on-site service visit is required if the problem cannot be resolved remotely.

16.8 Data Protection

Please read this information on data protection.

The first time your appliance is registered on a home network connected to the Internet, your appliance transmits the following types of data to the Home Connect® server (initial registration):

- Unique appliance identification (consisting of appliance codes as well as the MAC address of the in-

stalled Wi-Fi communication module).

- Security certificate of the Wi-Fi communication module (to ensure a secure data connection).
- The current software and hardware version of your home appliance.
- Status of any previous reset to factory settings.

This initial registration prepares the Home Connect® functions for use and is only required when you want to use the Home Connect® functions for the first time.

Note: Please note that the Home Connect® functions can only be used in conjunction with the Home Connect® app. Information on data protection can be retrieved in the Home Connect® app.

17 Basic settings

You can configure the basic settings for your appliance to meet your needs.

Note: You can also adjust the basic settings in the Home Connect® app.

17.1 Overview of the basic settings

Note: Additional functions may be available as a result of software updates. → *Page 37*

If a software update is available, you can find further information in the Home Connect® app.

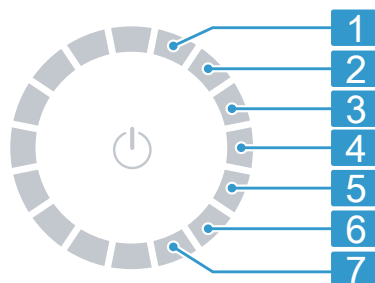

Program selector with program positions

-
- | | |
|----------|--|
| 1 | Set the volume of the signal tone that is emitted when the program ends:
0 (off) to 4 (very loud) |
| <hr/> | |
| 2 | Set the volume of the signal tone that is emitted when the buttons are selected:
0 (off) to 4 (very loud) |
| <hr/> | |
| 3 | Set the display brightness:
1 (low) to 4 (very high) |
| <hr/> | |
| 4 | Activate (on) or deactivate (off) the crease-reduction function.
Once the program has ended, the drum moves the laundry at regular intervals to prevent creasing. |
| <hr/> | |
| 5 | Activate (on) or deactivate (off) the reminder to clean the drum. |
| <hr/> | |
| 6 | Display the number of finished programs (PC). |
| <hr/> | |
| 7 | Restore the appliance to the factory settings (rES). |
-

17.2 Changing the basic settings

Requirement: The display shows all additional buttons. → *Page 22*

1. To call up the basic settings, press **Basic Settings** .
2. Use the program selector to select the required basic setting.
→ *Page 38*
3. Adjust the basic setting:
 - ▶ To change the value, press \wedge or \vee .
 - ▶ To reset the appliance to the factory settings, press and hold **II** ▶ for approx. 3 seconds.
4. To exit the basic settings, press **Basic Settings** .

18 Cleaning and maintenance

NOTICE

Heavy, sharp or rough objects may damage the appliance.

- ▶ Do not use hard or sharp objects, abrasive cleaning products or steel wool for cleaning.
- ▶ Clean the appliance using only water and a soft cloth.

Note: The Statement of Limited Product Warranty covers defects in materials and workmanship. Cleaning and maintenance is not covered by the warranty and a charge will apply. See the Statement of Limited Product Warranty for more details.

18.1 Cleaning the drum

Clean the drum if you have carried out 20 washing cycles at a temperature of Hot or lower, if ☉ flashes, or if you have not used the appliance for a prolonged period, but at least once a year.

⚠ CAUTION

Permanently washing at low temperatures and a lack of ventilation for the

appliance may damage the drum and cause injury.

- ▶ Regularly run a program for cleaning the drum or wash at temperatures of Extra Hot.
- ▶ Leave the appliance to dry after every operation with the door open, and leave the detergent drawer to dry.
- ▶ Run the **Drum Clean** program without laundry but with washing powder that contains oxygen bleach or a cleaning agent for caring for the inside of the appliance.

18.2 Cleaning the detergent drawer

If you want to replace the liquid detergent or fabric softener in the dispenser with another product or if the detergent drawer is dirty, clean the detergent dispenser.

NOTICE

The pump unit contains electrical components.

Electrical components may be damaged if they come into contact with liquids.

- ▶ Do not clean the pump unit in the dishwasher and do not immerse it in water.
- ▶ Protect the electrical connection on the rear against water, detergent and fabric softener residue.

Note: Scan the QR code to see an animation of the process.



en-us Cleaning and maintenance

1. Put the appliance into standby mode. → *Page 34*
2. Pull out the detergent drawer.
3. Press down on the insert and remove the detergent drawer.

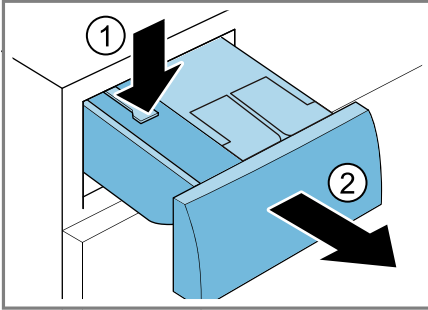

4. Remove the pump unit.

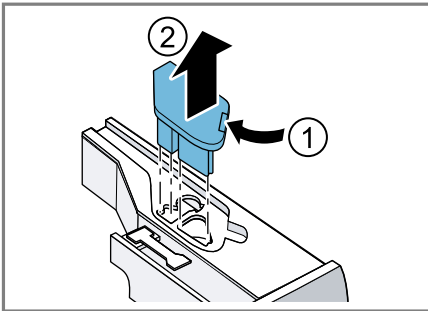

5. Unclip the detergent drawer cover and remove it.

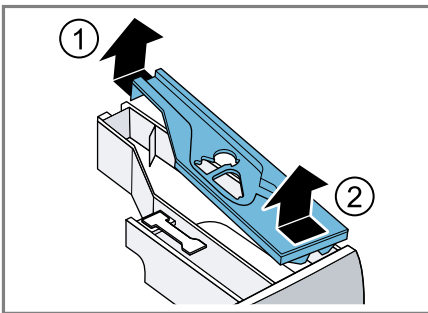

6. Empty the detergent drawer.

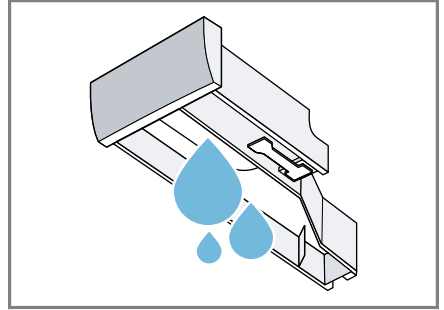

7. Clean the pump unit with a damp cloth.

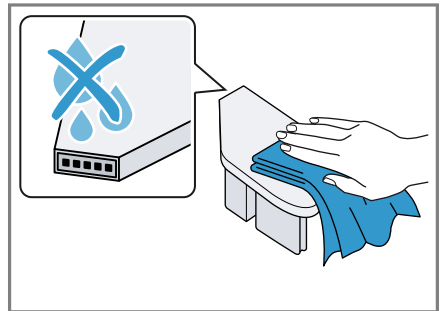

8. Clean the detergent drawer and the cover with a soft, damp cloth or hand shower.

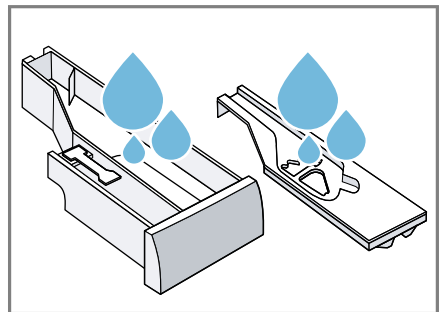

9. Dry the detergent drawer, cover and pump unit and reinsert them.

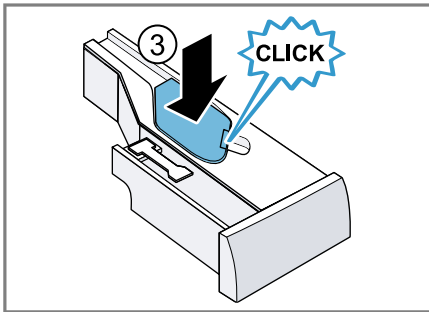
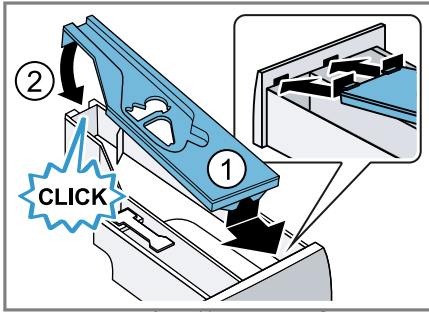

10. Clean the housing of the detergent drawer in the appliance.

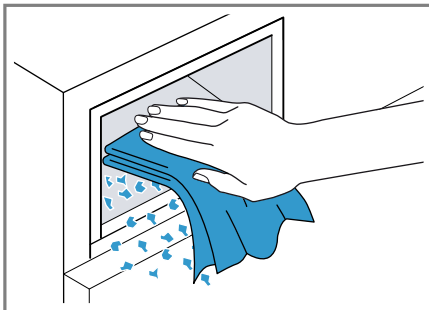

11. Push in the detergent drawer.

18.3 Cleaning the drain pump

Clean the drain pump regularly, at least once a year, as well as in the event of faults, e.g. blockages or rattling noises.

Note: Scan the QR code to see an animation of the process.

Observe the following safety instructions before you start the animation.



Emptying the drain pump

1. Turn off the faucet.
2. Put the appliance into standby mode. → Page 34
3. Disconnect the appliance's mains plug from the power supply.
4. Open and remove the service flap.

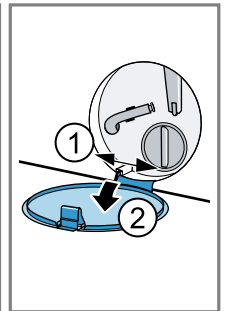
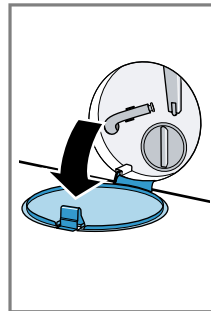

5. Loosen the screws and remove the protective film.

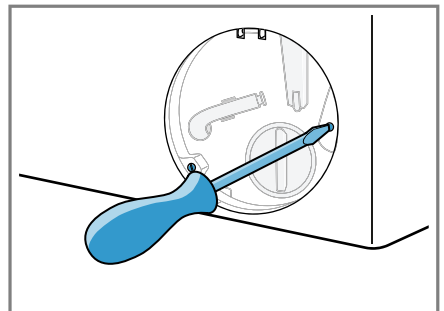

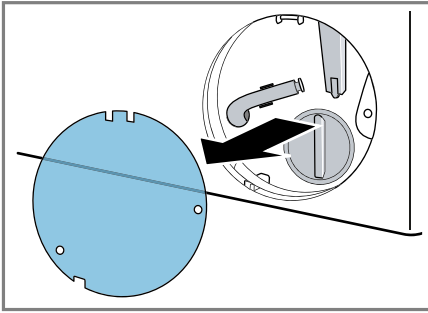

6. Slide a suitable receptacle under the opening for draining the detergent solution.

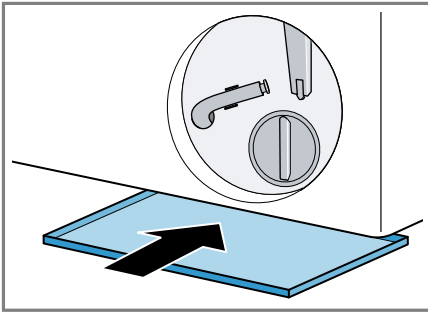

7. Take the drain hose out of the holder.

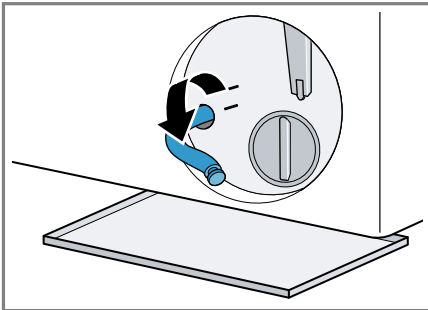

8. **⚠ CAUTION**

When you wash at high temperatures, the detergent solution becomes hot.

- ▶ Do not touch the hot detergent solution.

To allow the detergent solution to flow out into the container, remove the sealing cap.

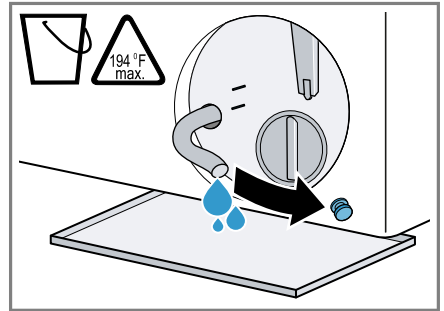

9. Once emptied, press firmly on the locking cap.

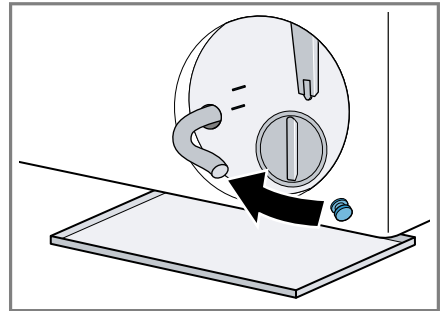

10. Clip the drain hose into the holder.

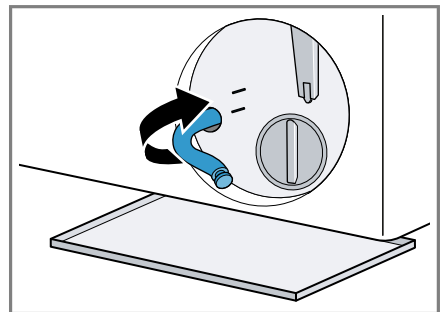

Cleaning the drain pump

Requirement: The drain pump is empty. → Page 41

1. Since water may remain in the drain pump, unscrew the pump cap carefully.
 - ▶ The filter insert in the pump housing may become stuck due to coarse particles of dirt. Loosen the dirt and remove the filter insert.

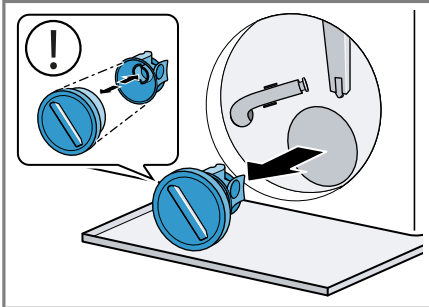

The pump cap is comprised of two parts which can be taken apart for cleaning.

2. Clean the interior, the thread on the pump cap and the pump housing.

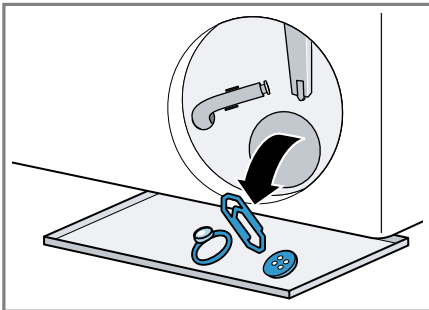

Color and dirt catcher sheets can block the drain pump. Only use color and dirt catcher sheets in a laundry net.

3. Ensure that both impellers can turn.

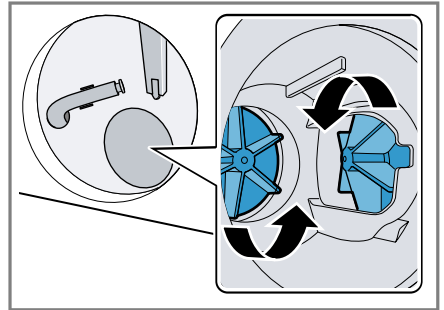

4. Insert the pump cap.
 - ▶ Ensure that the parts of the pump cap are correctly assembled.

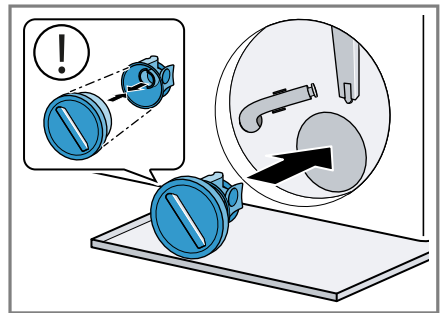

5. Screw the pump cap as far as it will go.

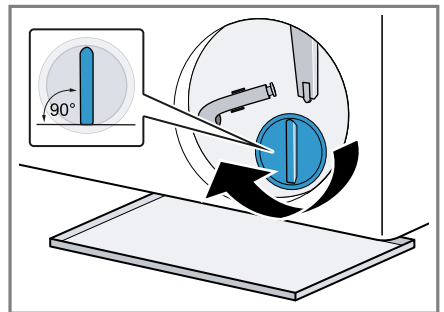

The handle on the pump cap must be in a vertical position.

6. Fit the protective film and secure with the screws.

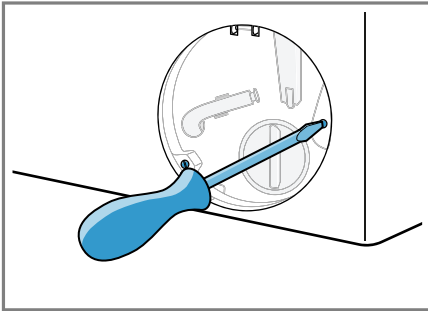
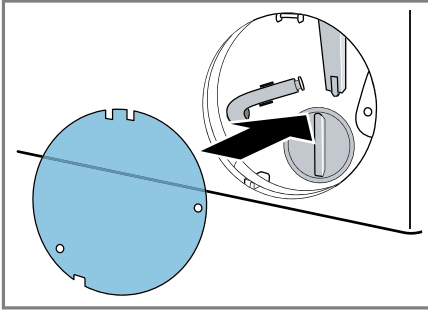

7. Insert and close the service flap.

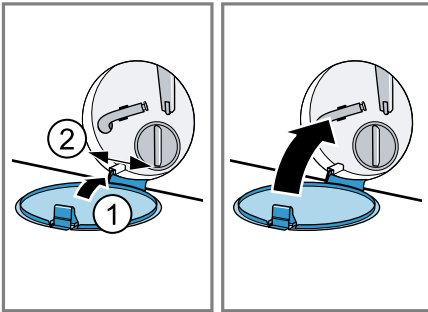

18.4 Cleaning the rubber gasket

Clean the rubber gasket regularly.

1. Open the door. → Page 32
2. Remove any foreign objects and fluff from the rubber gasket.

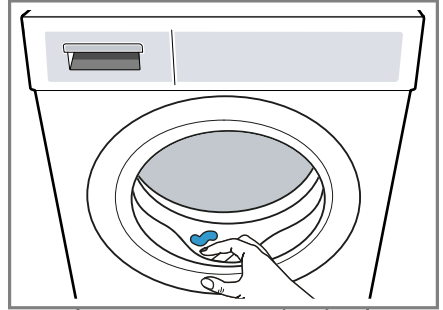

3. Remove any blockages from the inlet opening.

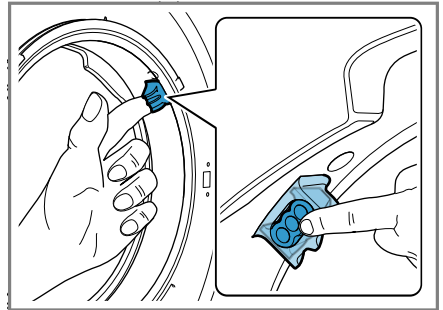

4. Clean the outside and the inside of the rubber gasket with a damp cloth and wipe dry.

19 Troubleshooting

You can eliminate minor issues on your appliance yourself. Please read the information on eliminating issues before contacting Customer Service. This may avoid unnecessary repair costs.



WARNING





To avoid risk of injury from improper repairs, observe the following.

- ▶ Never make any technical modifications to the appliance or its features.

- ▶ Do not tamper with controls.
- ▶ Only qualified technicians or authorized service providers should perform repairs.
- ▶ Only genuine spare parts may be used to repair the appliance.
- ▶ If the power cord of this appliance becomes damaged, it must be replaced by the manufacturer, the manufacturer's Customer Service, or an authorized service provider in order to prevent injury.

Fault	Cause and troubleshooting
The display goes out and II ▷ flashes.	Energy-saving mode is active. ▶ Press II ▷.
E:36 -10 / E:30 -80 The detergent solution is not being pumped out.	The water outlet hose is connected too high, is kinked or trapped, or has been extended impermissibly. ▶ Check the installation of the water outlet hose. → <i>Page 16</i>
	Drain pipe or water outlet hose is blocked. ▶ Clean the drain pipe and the water outlet hose.
	The drain pump is blocked or the pump cover is not installed correctly. ▶ Check that the pump cover is installed correctly. → <i>Page 41</i> ▶ Clean the drain pump. → <i>Page 41</i>
	Detergent dosage is too high. ▶ If intelligent dosing is activated, reduce the basic dosage. → <i>Page 35</i> ▶ If you dose manually, reduce the amount of detergent for the next washing cycle with the same load.
E:36 -25 -26	Drain pump is blocked. ▶ Clean the drain pump. → <i>Page 41</i>
E:38 -25 -26	Drain pump is blocked. 1. Clean the drum. → <i>Page 39</i> 2. If the fault persists, clean the drain pump. → <i>Page 41</i>
	Inlet opening of the rubber gasket is blocked. ▶ Clean the inlet opening in the rubber gasket. → <i>Page 44</i>
E:10 -00 -10 -20	The pump for the intelligent dosing system is blocked. 1. Clean the detergent drawer. → <i>Page 39</i> 2. If the fault persists, call customer service. → <i>Page 51</i>
	Note: Until the fault is rectified, you can deactivate the intelligent dosing system and dose manually. → <i>Page 24</i>

Fault	Cause and troubleshooting
H:32	<p>The appliance has interrupted the spin cycle because the laundry is unevenly distributed.</p> <ul style="list-style-type: none"> ▶ Redistribute the laundry in the drum.
E:30 -10 / E:92 -01 / 	<p>Faucet is turned off.</p> <ul style="list-style-type: none"> ▶ Turn on the faucet. <hr/> <p>The water inlet hose is kinked or jammed.</p> <ul style="list-style-type: none"> ▶ Check the installation of the water inlet hose. → <i>Page 16</i> <hr/> <p>The filters in the water inlet are blocked.</p> <ul style="list-style-type: none"> ▶ Clean the filters in the water inflow. <p>Scan the QR code to see an animation of the process.</p> 
	<p>The water pressure is low.</p> <ul style="list-style-type: none"> ▶ Check whether the faucet has sufficient water pressure. <hr/> <p>The water level measuring system is defective. With this fault message, the appliance starts a draining process.</p> <ol style="list-style-type: none"> 1. Wait approx. 5 minutes until the draining process ends. 2. Restart the appliance. If required, start the draining process again. 3. If the fault persists, call customer service. → <i>Page 51</i>
E:30 -20	<p>Critical malfunction.</p> <ul style="list-style-type: none"> ▶ Turn off the faucet. <p>With this fault message, the appliance starts a draining process.</p> <ol style="list-style-type: none"> 1. Wait approx. 5 minutes until the draining process ends. 2. Restart the appliance. If required, start the draining process again. 3. If the fault persists, call customer service. → <i>Page 51</i> <hr/> <p>Detergent dosage is too high.</p> <ul style="list-style-type: none"> ▶ If you dose manually, reduce the amount of detergent for the next washing cycle with the same load.

Fault	Cause and troubleshooting
E:30 -20	Additional water has been added. <ul style="list-style-type: none"> ▶ Do not add any extra water to the appliance while it is operating.
All other fault codes.	Operational fault <ol style="list-style-type: none"> 1. To restart the appliance, press and hold  for approximately 5 seconds. 2. If the fault occurs again, disconnect the appliance from the power supply for at least 30 seconds. Unplug the power plug or switch off the circuit breaker in the fuse box. 3. If the fault persists, call customer service. → <i>Page 51</i> Please specify the exact error message when calling. If possible, document the fault with photos and videos.
	The detergent drawer has not been pushed in fully. <ul style="list-style-type: none"> ▶ Push in the detergent drawer. <hr/> The pump unit is not inserted correctly. <ul style="list-style-type: none"> ▶ Check that the pump unit is inserted correctly. → <i>Page 39</i>
 or heavy foam build-up.	Detergent dosage is too high. <ul style="list-style-type: none"> ▶ Mix one tablespoon of fabric softener with 2.1 cups (0.5 l) of water and pour the mixture into the compartment for manual dosing (not for outdoor clothing, sportswear, or items stuffed with down). ▶ If intelligent dosing is activated, reduce the basic dosage. → <i>Page 35</i> ▶ If you dose manually, reduce the amount of detergent for the next washing cycle with the same load.
	Drum cleaning is required. <ul style="list-style-type: none"> ▶ Clean the drum. → <i>Page 39</i>
The display and buttons do not respond.	Software fault. <ol style="list-style-type: none"> 1. To restart the appliance, press and hold  for approximately 5 seconds. 2. If the fault occurs again, disconnect the appliance from the power supply for at least 30 seconds. Unplug the power plug or switch off the circuit breaker in the fuse box.
Home Connect® is not working properly.	Various causes are possible. <ol style="list-style-type: none"> 1. Reset the appliance network settings. → <i>Page 37</i> 2. Set up Home Connect® again. → <i>Page 36</i> <ul style="list-style-type: none"> ▶ Go to www.home-connect.com.

Fault	Cause and troubleshooting
<p>i-DOS 1/i-DOS 2 cannot be pressed.</p>	<p>The selected program or program progress does not allow intelligent dosing.</p> <ul style="list-style-type: none"> ▶ Use the manual dosing compartment. → <i>Page 35</i>
<p>The program does not start.</p>	<p>The control panel lock is activated.</p> <ul style="list-style-type: none"> ▶ Deactivate the control panel lock. → <i>Page 34</i> <hr/> <p>Finish in is activated.</p> <ul style="list-style-type: none"> ▶ Check whether Finish in is activated. → <i>Page 25</i> <hr/> <p>The detergent drawer has not been pushed in fully.</p> <ul style="list-style-type: none"> ▶ Push in the detergent drawer.
<p>The program is paused or has been interrupted, but the door will not open.</p>	<p>Temperature is too high.</p> <ul style="list-style-type: none"> ▶ Start the Rinse program or wait until the temperature has dropped. <hr/> <p>Water level is too high.</p> <ul style="list-style-type: none"> ▶ Start the Spin program or a suitable draining program. → <i>Page 26</i>
<p>The door cannot be opened due to a power outage.</p>	<p>The door is locked.</p> <ul style="list-style-type: none"> ▶ Open the door using the emergency release. → <i>Page 50</i>
<p>Drum jerks after the program starts.</p>	<p>Not a fault. An internal motor test is started. No action required.</p>
<p>Drum rotates, water does not flow in.</p>	<p>Not a fault. Load detection is active for up to 2 minutes. No action required.</p>
<p>There is no water visible in the drum.</p>	<p>Not a fault. Water is below the visible area. No action required.</p>
<p>Drum starts rotating briefly several times.</p>	<p>Not a fault. The appliance eliminates an imbalance by repeatedly redistributing the laundry. No action required.</p>
<p>The appliance is vibrating, 'wandering', and making loud noises during the spin cycle.</p>	<p>Appliance is not correctly aligned.</p> <ul style="list-style-type: none"> ▶ Align the appliance. → <i>Page 17</i> <hr/> <p>The appliance feet are not fixed.</p> <ul style="list-style-type: none"> ▶ Secure the appliance's feet. → <i>Page 17</i> <hr/> <p>Transit bolts have not been removed.</p> <ul style="list-style-type: none"> ▶ Remove the transit bolts.
<p>High spin speed not reached.</p>	<p>The appliance is using a reduced spin speed to eliminate an imbalance. No action required.</p>

Fault	Cause and troubleshooting
The program duration changes during the wash cycle.	Not a fault. The program sequence is optimized electronically, another rinse cycle is switched on due to heavy foam build-up, or an imbalance is eliminated. No action required.
Whooshing, hissing, whirring, or sucking noises.	Not a fault. Water is pumped in, detergent and fabric softener is dosed, function tests are performed, or detergent solution is pumped out. No action required.
Banging noises, rattling in the drain pump.	A foreign object is in the drain pump. ▶ Clean the drain pump. → <i>Page 41</i>
Insufficient cleaning or detergent residues on the laundry.	Detergents may contain water-insoluble substances that deposit on the laundry. ▶ Start the Rinse program or brush out the laundry after drying.
	The detergent in the dispenser is unsuitable or thickened. 1. Check whether the detergent is suitable. → <i>Page 31</i> 2. Check whether the detergent in the dispenser has thickened. 3. If the detergent is unsuitable or has thickened, empty it out and clean the dispenser. → <i>Page 39</i>
	The basic dosage is not correctly adjusted. ▶ Set the basic dosage. → <i>Page 35</i>
The laundry is too wet after the spinning cycle.	A low spin speed is selected. ▶ Start the Spin program. ▶ The next time you run a wash cycle, set a higher spin speed.
	The appliance is using a reduced spin speed to eliminate an imbalance. 1. Redistribute the laundry in the drum. 2. Start the Spin program.
Creasing.	The selected program is unsuitable for the type of fabric. ▶ Set a suitable program. → <i>Page 26</i>
	A high spin speed is selected. ▶ The next time you run a wash cycle, set a lower spin speed.
	The load is unsuitable. ▶ Observe the program's maximum load capacity. → <i>Page 26</i> ▶ Prepare the laundry. → <i>Page 31</i>

Fault	Cause and troubleshooting
Water is leaking out at the water inlet hose.	The water inlet hose is not correctly connected or is damaged. <ul style="list-style-type: none"> ▶ Check the installation of the water inlet hose. → <i>Page 12</i> Replace the water inlet hose if it is damaged.
Water is leaking out at the water outlet hose.	The water outlet hose is not connected correctly or is damaged. <ul style="list-style-type: none"> ▶ Check the installation of the water outlet hose. → <i>Page 12</i> Replace the water outlet hose if it is damaged.
Water is leaking from below the door.	Dirt on the door or seal causes leaks. <ul style="list-style-type: none"> ▶ Clean the door and the seal.
Odors have formed in the appliance.	Humidity and detergent residue may promote the formation of bacteria. <ul style="list-style-type: none"> ▶ Clean the drum. → <i>Page 39</i> ▶ If you are not using the appliance, leave the door and detergent drawer open so that residual water can evaporate.

19.1 Emergency release

Releasing the door

Requirement: The drain pump is empty. → *Page 41*

1. **NOTICE:** Escaping water may cause material damage.
 - ▶ Do not open the door if you can see water through the glass.

Pull the emergency release downwards with a tool and release.

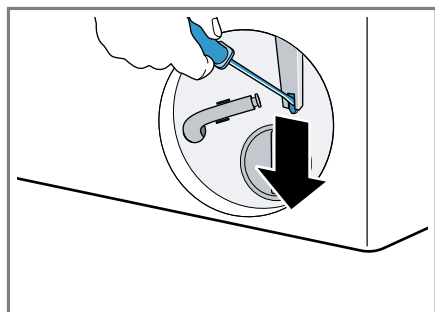

- ✓ The door lock is released.

2. Insert the service flap and lock it into place.
3. Close the service flap.

20 Transportation, storage and disposal

20.1 Removing the appliance

1. Turn off the tap.
2. Put the appliance into standby mode. → *Page 34*
3. Unplug the appliance's mains plug.
4. Drain the water. → *"Cleaning the drain pump", Page 41*
5. Detach the hoses.
6. Empty the dispensers.

20.2 Inserting the transit bolts

Secure the appliance before transportation using transit bolts in order to prevent transport damage.

1. Use a screwdriver to remove the cover cap¹.

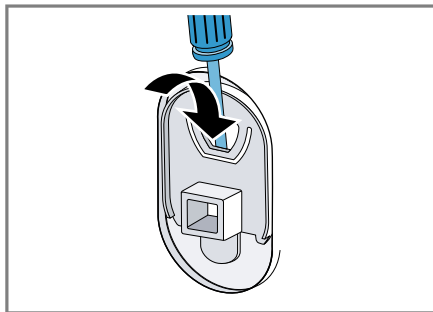

Retain the cover cap.

2. Insert the 4 transit bolts.

20.3 Using the appliance again

- ▶ For further information, see Installation and connection → *Page 12* and Starting an empty washing cycle → *Page 18*.

20.4 Disposal of your old appliance

Environmentally compatible disposal allows valuable raw materials to be recycled.

⚠ WARNING

Children can lock themselves in the appliance, thereby putting their lives at risk.

- ▶ The appliance must not be set up behind a lockable door, a sliding door or a door with a hinge on the side opposite to the appliance, which prevents appliance from opening fully.
- ▶ With redundant appliances, pull out the mains plug of the power cord, cut through the power cord and remove the appliance door.

1. Unplug the appliance from the power supply.
2. Cut through the power cord.
3. Remove the appliance door.
4. Dispose of the appliance in an environmentally responsible manner. Information about current disposal methods can be obtained from your specialist dealer or local authority.

21 Customer Service

With any warranty repair, we will make sure your appliance is repaired by an authorized service provider using genuine replacement parts. We use only genuine replacement parts for all repairs.

You can obtain function-relevant and storable genuine spare parts from our Customer Service for up to 15 years from the date on which your appliance was placed on the market. For more information, please contact our Customer Service team.

Detailed information on the warranty period and terms of warranty can be found in the Statement of Limited Product Warranty, from your retailer, or on our website.

USA:

1-800-944-2904

www.bosch-home.com/us/owner-support/get-support

www.bosch-home.com/us/shop

CA:

1-800-944-2904

www.bosch-home.ca/en/service/get-support

www.bosch-home.ca/en/service/cleaners-and-accessories

¹ The number of cover caps varies depending on the model.

en-us Technical specifications

For assistance with connecting to Home Connect®, you can also view instructions here:
www.home-connect.com/us/en/help-support/set-up

21.1 Model number (E-Nr.), production number (FD) and consecutive numbering (Z-Nr.)

If you contact Customer Service, you will need the product number (E-Nr.), production number (FD), and consecutive numbering (Z-Nr.), which you can find on the appliance's rating label.

Depending on the model, the rating plate can be found:

- on the inside of the door.
- underneath the drum opening.
- on the inside of the service flap.
- on the backside of the appliance.

Making a note of your appliance's details and the Customer Service telephone number will enable you to find them again quickly.

22 Technical specifications

Weight	184.5 lbs
Drum volume	2.4 ft ³
Mains voltage	208-240 V, 60 Hz
☞ Minimum installation protection	10,5 A
Power rating	2300 W
Water pressure	<ul style="list-style-type: none">▪ Minimum: 14.5 psi (100 kPa)▪ Maximum: 145 psi (1000 kPa)

Ambient temperature	<ul style="list-style-type: none">▪ Minimum: 41 °F (5 °C)▪ Maximum: 95 °F (35 °C)
Relative humidity	< 95 %
Length of the water inlet hose	47" (119.4 cm)
Length of the water drain hose	57" (144.8 cm)
Length of the power cord	64 ⁷ / ₈ " (165 cm)

Appliance dimensions

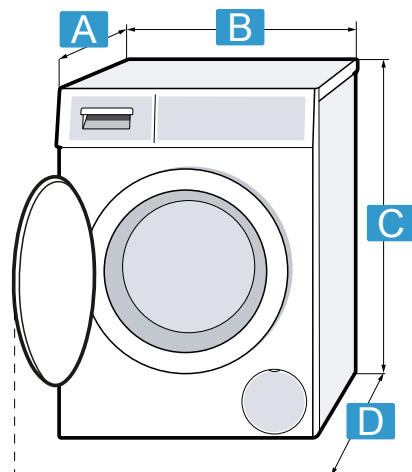

A	Appliance depth: 23 ¹ / ₄ " (59.0 cm) Appliance depth with door closed: 25 ¹ / ₂ " (64.8 cm)
B	Appliance width: 23 ¹ / ₂ " (59.8 cm)

C Appliance height¹: 33 1/4"
(84.5 cm)

D Appliance depth with door
open: 43" (109.0 cm)

22.1 Information regarding Free and Open Source Software

This product includes software components that are licensed by the copyright holders as free or open source software.

The applicable license information is stored on your home appliance. You can also access the applicable license information via your Home Connect® app: "Profile -> Legal information -> License Information".² You can also download the license information on the brand product website. (Please search on the product website for your appliance model and additional documents). Alternatively, you can request the relevant information from ossrequest@bshg.com or BSH Hausgeräte GmbH, Carl-Wery-Str. 34, 81739 Munich, Germany.

The relevant source code will be made available to you on request. Please send your request to ossrequest@bshg.com or BSH Hausgeräte GmbH, Carl-Wery-Str.34, 81739 Munich, Germany.

Subject: „OSSREQUEST“

The cost of performing your request will be charged to you. This offer is valid for three years from the date of purchase or at least as long as we offer support and spare parts for the relevant appliance.

¹ When aligning the appliance, the appliance height may increase by up to 1/2" (1.2 cm).

² Depending on the appliance specifications



Register your appliance to enjoy customized benefits.

Thank you for being a Bosch customer!
Simply create a MyBosch account, then register your appliance.
You'll find a variety of customized information in MyBosch such as:

- **Discounts for filters, cleaners, accessories & parts**
- **Easy access to manuals & appliance specifications**
- **Easy access to part lists**
- **Customized offer for the Bosch Appliance Service Plan (sent by mail after appliance registration)**

Register here:

www.bosch-home.com/us/owner-support/mybosch



Looking for help? You'll find it here.

No matter what, no matter when: Bosch is here to support you.
We're here to assist with usage instructions, cleaning tips, accessories & parts, troubleshooting, and repairs.
Find online resources such as FAQs, how-to-videos, manuals, warranties and authorized Bosch servicers at:

www.bosch-home.com/us/owner-support/get-support

Contact us:

Please have your model Number (E-Nr) ready when contacting us.

1-800-944-2904

www.bosch-home.com/us/owner-support/contact-us

BSH Home Appliances Corporation

1901 Main Street, Suite 600

Irvine, CA 92614

USA

www.bosch-home.com

1-800-944-2904

© 2026 BSH Home Appliances Corporation



9001853079 (060326)

en-us