

SINK SPECIFICATIONS



ELONGATED DOUBLE BOWL Undermount
Model VGR3218BL

FEATURED MODEL VGR3218BL
 9" BOWL DEPTH

FEATURES

- 18 gauge, stainless steel
- 304 Nickel - Bearing Content
- Long-lasting, easy-to-clean, satin finish
- Sound-deadening insulation
- Rear drain placement

PACKING LIST

- SINK
- CUT-OUT TEMPLATE
- MOUNTING BRACKETS



NOMINAL DIMENSIONS

MODEL #	BOWL SIZE	SINK DEPTH	EXTERIOR DIM.	GAUGE
VGR3218BL	14 5/8" x 16 1/2"	9"	32 1/4" x 18 1/2"	18
	14 5/8" x 16 1/2"	9"		

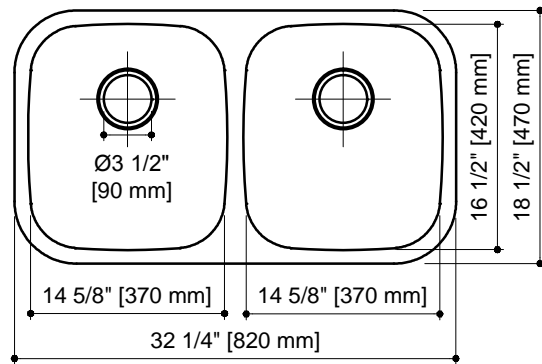

TOP VIEW

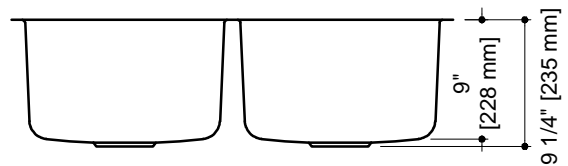

FRONT VIEW



Installation instructions Undermount Sinks

Before you begin:

Please carefully read these instructions.

Unpack and inspect the sink carefully. Do not install the sink if it is damaged.

Save all original packaging and receipts.

Check and follow all local plumbing codes.

General Recommendations:

Read installation and maintenance instructions, thoroughly before installation.

Be sure to use proper tools and always wear personal safety accessories for your protection

Long-Life Care

Vigo Stainless Steel Sinks are easy to keep looking new, longer with minimal care. For best results, always rinse with a mild soap and wipe after each use. Rub lightly with soft cloth in the direction of the grain line on a regular basis. To avoid damage and discoloration to the sink surface never use a steel wool or scouring pad.

Tools and Materials needed:

Tape Measure

Pencil (NOT ink)

Silicone Adhesive Sealant

Rags

Denatured Alcohol

Ear Protection

Eye Protection

Hacksaw/Jigsaw

Mounting clips (included)

Installation Instructions

Please carefully read complete instructions before beginning installation. Only a professional stone fabricator is qualified to perform this installation.

Note: These instructions are for installation with solid surface, composite material countertops. Vigo recommends professional countertop installers and is not responsible for damage to the countertop or sink during installation.

 Do not cut the sink opening with traditional saw cut method.

1. Unpack the new sink and check the contents of the materials supplied: Sink, Mounting brackets, and Cutout template (depending on model). Contact your retailer if any product is damaged or missing prior to installation. Never install a damaged sink as it can void your warranty.
2. Supplied cutout template provides two options of installation:
 - A. Flush mount: Sink edge is flush with countertop opening. (FIGURE 1)
 - B. Reveal mount: Sink rim is exposed approximately 1/4" from the edge of countertop opening. (FIGURE 2)

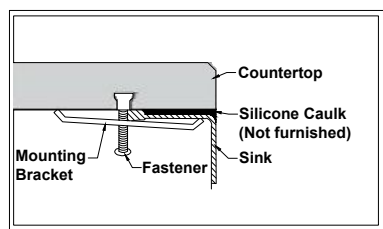

Figure 1

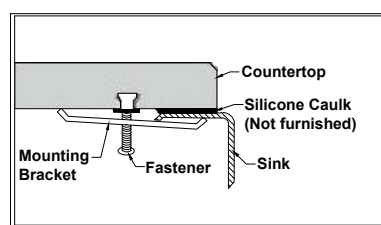

Figure 2

3. Cut out the appropriate template for your sink model and desired installation option. Place template in desired position on countertop, locating center of the bowl over cabinet and faucet holes.
4. Trace the outline of the template and cut countertop along the inside of the line using appropriate cutting tools. Template is for guide only. Use physical sink to ensure accurate cutout opening.
5. Locate the drill holes on the underside of the countertop, approximately 1" from edge of the sink to be installed. Holes should be evenly spaced approximately 6" to 8" apart starting from every corner as shown in Figure 3. It is recommended to install a faucet at this point before installing the sink.

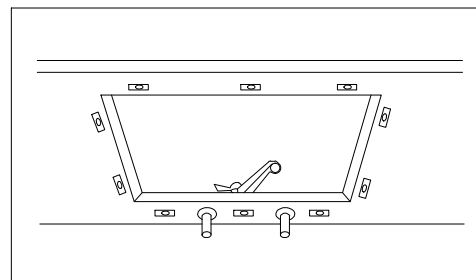

Figure 3

6. Loosely attach mounting brackets to the countertop, parallel to the cutout opening using the supplied mounting screws and nuts. Mounting screws with brass inserts are supplied with the sink, however, countertop material vary and the correct type of fasteners should be recommended by your installer or supplier.
7. Clean sink flange and underside of cutout area of countertop, making sure that the area is smooth and free of grease. **MUST** use 100% silicone for this installation. Apply continuous bead of silicone caulk evenly on top of sink flange. (FIGURE 4) **NEVER** perform this procedure outdoor and under sunlight. If performed under an extremely hot and dry climate, the caulking of the sink frame should be performed by two people at the same time.
8. Position and align sink over the countertop opening and press sink onto countertop. Turn bent end of mounting bracket to snug over the sink rim.
9. Check alignment of sink again and tighten fasteners to secure sink. (FIGURE 5)
10. Wipe away excess silicone caulk with damp cloth. Connect drain and water supply according to manufacturer's instruction.

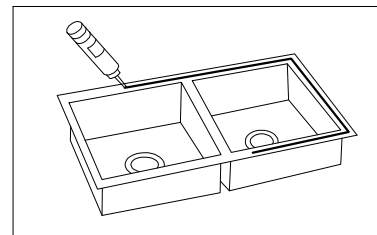

Figure 4

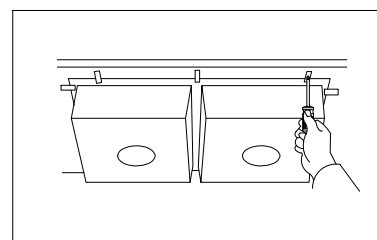

Figure 5

Care and Maintenance

ALWAYS

- Clean everyday by thoroughly rinsing with a mild soap and warm water and wipe dry.
- Rub lightly with a soft cloth in the direction of grain lines on a regular basis for additional preventative cleaning.
- Keep the sink free of any standing water as this can cause a buildup of mineral deposit, which can affect the appearance of your sink.
- Any stubborn stains should be removed by scrubbing in the direction of the grain with a mild abrasive such as Comet.
- Always rinse the sink after using any cleaning agent and wipe dry. Clean any mineral deposits built up over time with a mild solution of vinegar and water followed by a thorough flushing with water.
- Remove any scratches with a Scotch-brite pad and cleaning agent rubbing in the direction of the grain.
NOT RECOMMENDED FOR MIRROR FINISH.

NEVER

- Leave water spots, steel cookware or utensils in the sink for lengthy periods; iron particles often develop rust spots in the stainless steel surface.
- Use a steel wool or scoring pad as it damages the sink surface and causes discoloration.
- Let household cleaning agents or bleach sit in your sink for long period of time as this may ruin the finish of your sink.
- Leave rubber mats, sponges, or cleaning pads in the sink for long period of time as this may ruin the finish of your sink.
- Use any drain cleaning products containing sulfuric acid or hydrochloric acid as this will attack the sink. Silver cleaners can also contain acids that will damage the sink surface.
- Use the inside of the sink as cutting surface.



VIGO INDUSTRIES, LLC ("VIGO")
KITCHEN SINK LIMITED LIFETIME WARRANTY

EFFECTIVE JANUARY 1, 2010

VIGO offers the following limited warranty on each of its Kitchen Sink products* (the "Product"). This warranty extends only to the original owner or end-user for personal household use. For commercial uses, additional limitations apply.

VIGO warrants the Product to be free from defects in workmanship and materials under normal use and service for the period commencing from the initial date of purchase by the owner or end-user, contractor, or builder, from VIGO or an authorized VIGO dealer, through the lifetime of the original owner or end-user.

Subject to the Warranty Service provision below, any product reported to the authorized dealer or to VIGO as being defective within the warranty period will be repaired or replaced (with a product of equal value) at the option of VIGO. This warranty extends to the original owner or end-user and is not transferable to a subsequent owner.

Neither the distributor, authorized VIGO dealer, nor any other person has been authorized to make any affirmation, representation, or warranty other than those contained in this warranty. Any affirmation, representation, or warranty other than those contained in this warranty shall not be enforceable against VIGO or any other person.

VIGO reserves the right to modify this warranty at any time, it being understood that such modifications will not alter the warranty conditions applicable at the time of sale of the products in question.

Limitations

This warranty shall not apply to instances of incorrect operating procedures, breakages, or damages caused by fault through improper installation, carelessness, abuse, misuse, misapplication, improper maintenance, or alteration of the Product, as well as chemical or natural corrosion, accident, fire, flood, an act of God, or any other casualty. Avoid abrasive cleaners, steel wools, and harsh chemicals as these will scratch, damage, and / or dull the product and / or finish and void this warranty. The owner/end-user of the Product covered by the present warranty is entirely responsible for its proper installation and any applicable plumbing or electrical wiring. VIGO neither installs nor supervises the installation nor hires a contractor for this purpose; consequently, VIGO cannot be held responsible for any default, breakage, or damages caused thereby or resulting thereof, either directly or indirectly.

The owner/end-user must provide access to the components of the Product as described in the installation guide so that VIGO can execute the warranty specified herein. If such access is not available, all expenses to provide said access will be the responsibility of the owner/end-user.

This warranty does not apply to Products that have not been installed or operated in accordance with instructions supplied by VIGO and all applicable rules, regulations, and legislation pertaining to such installations.

This warranty does not apply unless the VIGO Product is installed by fully insured licensed professionals. VIGO strongly recommends that such licensed professionals have experience in the installation of bathroom and kitchen products. Installation of certain products, including, without limitation, glass products (i.e., shower doors and glass sinks) by an inexperienced person may result in glass breakage and, consequently, cause personal injury or death.

VIGO is not liable for personal injuries or deaths to any persons or for any direct, special, incidental, or consequential damage, loss of time, loss of profits, inconvenience, incidental expenses, labor or material charges, or any other costs resulting from the use of the product or equipment or pertaining to the application of the present warranty, or resulting from the removal or replacement of any product or element or part covered by this warranty.

EXCEPT AS OTHERWISE PROVIDED ABOVE, VIGO MAKES NO WARRANTIES, EXPRESSED OR IMPLIED, INCLUDING WARRANTIES OF MERCHANTABILITY AND FITNESS FOR A PARTICULAR PURPOSE OR COMPLIANCE WITH ANY CODE.

In any case, VIGO cannot be held liable for any amount over and above the purchase price paid for the Product by the owner/end-user, contractor, or builder.

Commercial Limitations

In addition to the above conditions and limitations, the warranty period for products installed for commercial applications or used in commercial ventures is one (1) year from the initial date of purchase by the owner/end-user, contractor, or builder from an authorized dealer. VIGO is not responsible for loss of use or profit under any circumstances. If the product is used as a display, the warranty period begins when the product is placed on display. This warranty gives the owner/end-user specific legal rights. The owner/end-user may also have other rights which can vary from one state or province to another.

Warranty Service

In order to obtain service provided under this warranty during regular business hours, contact the dealer or distributor who sold the unit, or contact VIGO directly. VIGO will provide the warranty service described above when the following conditions have been met: the failure is of the nature or type covered by the warranty; the user has informed an authorized VIGO Agent or VIGO's warranty service department representative of the nature of the problem during the warranty period; conclusive evidence (e.g., proof of purchase or installation) is provided to the foregoing by the user proving that the failure occurred or was discovered within the warranty period; an authorized independent service person or company representative has been permitted to inspect the product during regular business hours within a reasonable time after the problem was reported by the user. VIGO's warranty obligation shall be discharged upon tender of replacement or repair. The customer's refusal to accept the tender terminates VIGO's warranty obligations.

*Certain models are pending approval.

Certification may be ended by VIGO or certification agencies without notice.