

ZLINE

ATTAINABLE LUXURY[®]

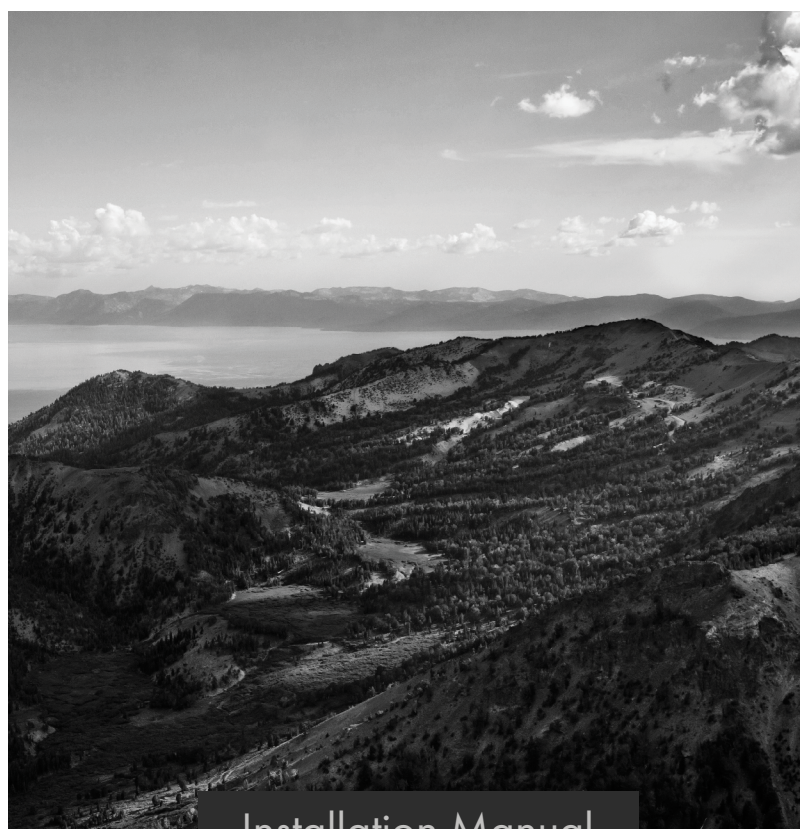

Installation Manual

RANGE TOPS

PCRT, PSRT, & SRT MODELS

zlinekitchen.com



ZLINE Kitchen and Bath provides Attainable Luxury, where the kitchen and bath of your dreams is never out of reach. Through our unique designs and unparalleled quality, we're dedicated to providing you an elevated experience in the heart of your home. With an endless selection of features and finishes, our inspiration is your reality.

ZLINE
ATTAINABLE LUXURY®



ZLINE is fueled by a passion for innovation; A relentless pursuit of bringing the highest end luxury designs and professional features into everyone's homes.

Because we continually strive to improve our products, we may change specifications and designs without prior notice.

Scan the QR code to view the most up-to-date version of the Installation Manual and User Manual.

⚠ WARNING: This product can expose you to chemicals including nickel, which is known to the State of California to cause cancer. For more information, go to www.P65Warnings.ca.gov.

TABLE OF CONTENTS

IMPORTANT SAFETY INSTRUCTIONS	1
Gas Safety	1
Electric and Gas Safety	5
Cooktop Safety	8
Ventilation Safety	10
Gas Supply and Electrical Connection	11
BEFORE INSTALLATION	16
Dimensions and Clearances	17
Product Specifications	18
INSTALLATION	21
Gas Connection	21
Liquid Propane Gas Conversion Procedure (Optional).	25
Manual Flame Adjustment.	40
Installing Parts	42
WARRANTY	46

IMPORTANT SAFETY INSTRUCTIONS

GAS SAFETY



WARNING: If the information in these instructions is not followed exactly, a fire or explosion may result causing property damage, personal injury or death.

- Do not store or use gasoline or other flammable vapors and liquids in the vicinity of this or any other appliance.
- **WHAT TO DO IF YOU SMELL GAS**
 - Do not try to light any appliance.
 - Do not touch any electrical switch.
 - Do not use any phone in your building.
 - Immediately call your gas supplier from a neighbor's phone. Follow the gas supplier's instructions.
 - If you cannot reach your gas supplier, call the fire department.
- Installation and service must be performed by a qualified installer, service agency or the gas supplier.

IMPORTANT SAFETY INSTRUCTIONS



AVERTISSEMENT : Le non-respect à la lettre de ces instructions peut causer un incendie ou une explosion, qui pourrait entraîner des dommages matériels, des blessures ou la mort

- Ne pas entreposer ou utiliser d'essence ou tout autre liquide ou gaz inflammable à proximité de cet appareil ou de tout autre appareil.
- **EN PRÉSENCE D'UNE ODEUR DE GAZ :**
 - Ne tenter d'allumer aucun appareil ;
 - Ne toucher à aucun commutateur électrique ;
 - N'utiliser aucun téléphone dans l'immeuble ;
 - Appeler immédiatement le fournisseur de gaz à partir d'un téléphone situé à l'extérieur de l'immeuble ; Suivre les instructions du fournisseur de gaz ;
 - S'il est impossible de joindre le fournisseur de gaz, appeler le service des incendies.
- L'installation et la réparation doivent être effectuées par un installateur ou une agence de réparation ayant les qualifications requises ou par le fournisseur de gaz.

IMPORTANT SAFETY INSTRUCTIONS



WARNING

WARNING:

Never Operate the Top Surface Cooking Section of this Appliance Unattended.

- Failure to follow this warning statement could result in fire, explosion, or burn hazard that could cause property damage, personal injury, or death.
- If a fire should occur, keep away from the appliance and immediately call your fire department. **DO NOT ATTEMPT TO EXTINGUISH AN OIL/GREASE FIRE WITH WATER.**



ATTENTION

ATTENTION :

Ne faites jamais fonctionner la surface de cuisson, sur le dessus de cet appareil, sans surveillance.

- Le non-respect de cette mise en garde pourrait entraîner un incendie, une explosion ou un risque de brûlure et ainsi causer des dommages matériels, des blessures ou la mort.
- Si l'appareil prend feu, tenez-vous à l'écart et appelez immédiatement votre service des incendies. **NE TENTEZ JAMAIS D'ÉTEINDRE UN FEU DE GRAISSE OU D'HUILE EN L'ASPERGEANT D'EAU.**



WARNING

WARNING: Never use this appliance as a space heater to heat or warm the room. Doing so may result in carbon monoxide poisoning and overheating.



AVERTISSEMENT

AVERTISSEMENT: Ne JAMAIS utiliser cet appareil électroménager en guise de chauffe-électrique. Le fait de chauffer une pièce ainsi peut entraîner un empoisonnement au monoxyde de carbone ou une surchauffe du four.

IMPORTANT SAFETY INSTRUCTIONS

- Before beginning installation, please read and follow these important instructions for the safety of your home and the people living in it.
- The manufacturer will not be responsible for any damage to property or to persons caused by incorrect installation, improper use of the appliance, or failure to heed the warnings listed.
- The manufacturer reserves the right to make changes to its products when considered necessary and useful, without affecting the essential safety and operating characteristics.
- This appliance has been designed for non-commercial, domestic use only.
- Please observe all local, state, and national codes and ordinances. Please ensure the range top is properly grounded. The plug should always be accessible.
- The installer should leave these instructions with the consumer who should retain for local inspectors' use and for future reference.
- This manual does not cover all possible conditions that may occur during installation and/or operation. Always contact a qualified service technician or the manufacturer about problems you may not understand.



WARNING Installation and service on this product must only be conducted by a qualified installer, service agency, or gas supplier.

- The installation of appliance designed for manufactured (mobile) home installation must conform with the Manufactured Home Construction and Safety Standard, Title 24CFR, Part 3280 [formerly the Federal Standard for Mobile Home Construction and Safety, Title 24, HUD (Part280)] or with local codes where applicable.
- Installation of any gas-fired equipment should be made by a licensed plumber or gas fitter. A manual gas shut-off valve must be installed in the gas supply line for safety and ease of service.
- Please ensure that the altitude of your home is conducive for the use of gas cooking products. If the product is installed at higher altitudes above sea level, you may experience issues with gas pressure that will affect product performance. Please consult your local gas company for recommendations before purchasing or installing.

IMPORTANT SAFETY INSTRUCTIONS

IMPORTANT SAFETY ALERTS



DANGER

DANGER: When you see this symbol in the instructions, it indicates a hazardous situation which, if not avoided, could result in death or serious injury.



WARNING

WARNING: When you see this symbol in the instructions, it indicates a hazardous situation which, if not avoided, could result in minor or moderate injury.



DANGER

USE CARE WHEN UNPACKING THE PRODUCT

- Remove all tape and packaging before using the appliance.
- Carefully dispose of the product's shipping box, plastic bags, and all other packing materials after the appliance is unpacked.
- Boxes covered with rugs, bedspreads, sheets, or other materials can become air-tight chambers. Never allow children to play with packaging material.
- Remove all staples from the box. Staples can cause cuts and destroy finishes if they come in contact with other appliances or furniture.
- Do not remove the model/serial plate attached to the appliance; doing so will not only void the product warranty, it will limit the ability for future service to be conducted on the range top in an effective manner.



WARNING

ELECTRIC AND GAS SAFETY

- Be sure your appliance is properly installed and grounded by a qualified technician in accordance with all local codes and ordinances and with the National Fuel Gas Code ANSI Z223.1—latest edition and the National Electrical Code ANSI/NFPA No. 70—latest edition in United States, or CAN/CGA B149.1, B149.2, and the Canadian Electrical Code, Part 1, in Canada.
- Gas leaks cannot always be detected by smell. As such, gas suppliers recommend that you use a gas detector approved by UL or CSA. For more information, contact your gas supplier.
- If a gas leak is detected, refer to the “WHAT TO DO IF YOU SMELL GAS” alert on page 1.

IMPORTANT SAFETY INSTRUCTIONS



WARNING

Installation and service on this product must be performed by a qualified installer, servicer, or gas supplier. Ask the manufacturer to recommend a qualified technician and authorized repair service in your area.

- Know how to shut off gas supply at the meter and disconnect the electrical power to the appliance at the circuit breaker or fuse box in case of an emergency. Installers should also show appliance owners the location of the appliance gas shut-off valve and how to shut it off if necessary.
- Do not repair or replace any part of the appliance unless specifically recommended in this manual. All other servicing should be done only by a qualified technician. This may reduce the risk of personal injury and damage to the appliance.



DANGER

Always disconnect gas and power when servicing this product, especially for larger-scale repairs impacting important appliance functionality; failure to do so increases the risk of fire, explosion, injury, or death.

INSTALLATION SAFETY

- Never modify or alter the construction of the appliance by removing panels, wire covers, or any other part of the product.
- If the appliance is located near a window, NEVER hang long curtains or paper blinds on that window. They could blow over the surface burners and ignite, potentially causing a fire hazard.
- Ensure the kitchen or room where the appliance is installed is well ventilated by keeping the air intakes open and in good working order and/or by installing a range hood above the unit. It's recommended a ventilation hood is installed between 30" and 36" (762 mm and 914 mm) above the cooktop to allow for optimal air flow.



WARNING

An air curtain or other overhead range/range top hood, which operates by blowing downward airflow onto the range top, shall not be used/installed in conjunction with this gas range top.

IMPORTANT SAFETY INSTRUCTIONS

- If the appliance is used intensively for a long time, the effectiveness of the ventilation will have to be increased, for example by opening a window or increasing the power of the range hood operating above.
- Flammable materials and liquids should not be stored on the appliance or near surface units. This includes paper, plastic, and cloth items, as well as cookbooks, plastic ware, and towels. Do not store explosives such as aerosol cans on or near the appliance. Flammable materials may explode and result in fire or property damage.
- Keep the appliance area clear and free from combustible materials, gasoline, and other flammable vapors and liquids.
- Flammable materials should not be stored near surface units.

IN THE STATE OF MASSACHUSETTS, THE FOLLOWING INSTALLATION INSTRUCTIONS APPLY

- Installations and repairs must be performed by a qualified or licensed contractor, plumber, or gas fitter licensed by the State of Massachusetts.
- If using a ball valve, it must be a T-handle type.
- A flexible gas connector, when used, must not exceed 3' (914 mm).



WARNING

STATE OF CALIFORNIA PROPOSITION 65 WARNINGS

- The California Safe Drinking Water and Toxic Enforcement Act requires the Governor of California to publish a list of substances known to the state to cause birth defects or other reproductive harm and requires businesses to warn customers of potential exposure to such substances.
- Gas appliances can cause minor exposure to at least four main substances — benzene, carbon monoxide, formaldehyde, and soot — caused primarily by the incomplete combustion of natural gas or liquid propane fuels.
- Properly adjusted burners, indicated by a bluish rather than yellow flame, will minimize incomplete combustion. Exposure to these substances can also be minimized by venting with an open window or by using a ventilation fan or range hood.

IMPORTANT SAFETY INSTRUCTIONS



COOKTOP SAFETY

DANGER

- Do not store items of interest to children in the cabinets above the appliance or on the back splash of appliance.
- Children should not be left alone or unattended in the area where the appliance is in use. Do not allow children to climb, play, sit, or stand on or around any part of the appliance. Children climbing on the appliance to reach items could be seriously burned or injured.
- **DO NOT TOUCH THE COOKING SURFACE, BURNERS, GRATES, OR ANY AREAS NEAR THEM.** Surface burners or other parts of the range may be hot even though flames are not visible.
- Areas near surface burners or throughout the appliance may become hot enough to cause burns. During and after use, do not touch, or let clothing or other flammable materials touch, these areas until they have had sufficient time to cool.
- Do not wear loose-fitting or hanging garments while using the appliance. Do not let clothing or other flammable materials contact hot surfaces.
- Smother grease fires with a pan lid, or use baking soda, a dry chemical, or foam-type extinguisher. Use an extinguisher **ONLY** if:
 - You have a Class A, B, or C extinguisher and you know how to operate it.
 - The fire is small and contained in the area where it is started.
 - The fire department is being/has been called.
 - You can fight the fire with your back to an exit.
- When heating fat or grease, watch it closely. Fat or grease may catch fire if allowed to become too hot.
- Use only dry potholders and oven mitts. Moist or damp potholders on hot surfaces may result in burns from steam. Do not let potholders touch hot heating elements, flames, or burners. Do not use a towel or other bulky cloth instead of a potholder.
- Do not heat unopened food containers. Buildup of pressure may cause the container to burst and result in injury.
- Stepping, leaning, or sitting on this appliance can result in serious injuries and also damage the appliance.
- Know which knob controls which surface burner. Visually check that the burner has lit. Then adjust the flame so it does not extend beyond the edge of the pot/pan.
- Clean the appliance regularly to keep all parts free of grease that could catch fire. Exhaust fan ventilation range hoods and grease filters should be kept clean. Do not allow grease to accumulate on hoods or filters. Greasy deposits in the fan could catch fire.
- When cooking food, turn the hood fan on. Refer to hood manufacturer's instructions for cleaning and operation.

IMPORTANT SAFETY INSTRUCTIONS

- Pot/pan handles should be turned inward and not extend over surface burners. To reduce the risk of burns, ignition of flammable materials, and spillage due to unintentional contact with the pot/pan, the handle of the utensil should be positioned so that it is turned inward, and does not extend over adjacent surface burners.
- Do not use aluminum foil to line any part of the appliance. Use aluminum foil only to cover food during cooking. Improper use of these liners may result in risk of electric shock or fire. Use of aluminum foil on any part of the range may void the manufacturer's warranty.
- Only certain types of glass, ceramic, earthenware, or other glazed cookware are suitable for use without breaking due to sudden changes in temperature. Check the manufacturer's recommendations for appliance use.



WARNING Never leave surface burners unattended. Boilovers cause smoke and greasy spillovers that may ignite, or a pan that has boiled dry may melt.

- Do not use decorative surface burner covers. If a burner is accidentally turned on, the decorative cover will become hot and possibly melt. You will not be able to see that the burner is on. Burns will occur if the hot covers are touched. Damage may also be done to the appliance or burners because the covers may cause overheating. Air will be blocked from the burner and cause combustion problems.
- Always use a proper flame size. Adjust the flame size so it does not extend beyond the edge of the pot/pan. The use of undersized pots/pans will expose a portion of the burner flame to direct contact and may result in ignition of clothing. Adjusting the flame size to appropriate levels will also improve efficiency.
- Always use proper pot/pan and cookware sizes. This appliance is equipped with surface units of different sizes. Select cookware with flat bottoms large enough to cover the surface unit.
- 48" (1219 mm) models come with an enameled reversible cast iron griddle that can be placed vertically (front to back) atop any of the four grates on the range. Use care when placing and flipping the griddle to not damage the griddle or cast iron grates below.
- Make sure the griddle is completely cool to the touch before placing on or removing from the range to avoid risk of burns and injury.
- Do not use stove top grills on your gas appliance. If you use a stove top grill on a sealed gas burner, it will cause incomplete combustion and can result in exposure to carbon monoxide levels above allowable current standards. This can be hazardous to your health.

IMPORTANT SAFETY INSTRUCTIONS



VENTILATION SAFETY

WARNING

- The appliance should have proper ventilation in order to keep the unit operating properly and maintain the temperature of immediate surroundings. Do not obstruct flow of combustion and ventilation air.
- Observe all governing codes and ordinances, and check your local building codes as they may vary from the general rules outlined in this manual.
- It is the installer's responsibility to comply with installation clearances specified on the model/serial rating plate, in addition to within this Installation Manual.
- For proper operation of a gas appliance, the air necessary for gas combustion must be able to flow into the room naturally. The air must flow into the room directly through openings in the outside walls.
- These openings must be constructed so that it will not be obstructed from inside or outside, and not be constructed close to the floor. The opening is recommended to be on the side opposite to that on which the flue gases are discharged.
- The appliance should be located for convenient use in the kitchen; recessed installations must provide complete enclosure of the sides and rear of the range top.
- To eliminate risk of burns or fire by reaching overheated surface units, cabinet storage space located above the range top should be avoided. This risk can be further reduced by installing a range hood or microwave hood combination that projects horizontally a minimum of 5" (127 mm) beyond the bottom of the cabinets.
- If a ventilation range hood is installed with appropriate ducting, maintain a 30" (762 mm) minimum clearance between the cooking surface and bottom of the hood.
- Always turn on the ventilation range hood when the range is in use.
- Avoid placing cabinetry directly above the appliance when possible. If cabinetry is used above the cooking surface, use cabinets no more than 13" (330 mm) deep.
- Contact a service technician and/or a qualified floor covering installer to check that wall coverings, countertops, and cabinets located around the appliance can withstand at least 200 °F (93 °C).

BEFORE INSTALLATION

GAS SUPPLY AND ELECTRICAL CONNECTION

GAS SAFETY



Explosion hazard conditions will exist unless you perform ALL of the following; failure to do so can result in death, explosion, or fire.

- Use a new CSA International approved gas supply line.
- Install a manual gas shut-off valve.
- Securely tighten all gas connections.
- Examples of a qualified person include:
 - Licensed heating personnel
 - Authorized gas company personnel
 - Authorized service personnel
- Observe all governing codes and ordinances:
 - **IMPORTANT:** This installation must conform with all local codes and ordinances. In the absence of local codes, installation must conform with American National Standard, National Fuel Gas Code ANSI Z223.1/NFPA 54—latest edition, or CAN/CGA B149—latest edition.
 - In Canada, installation must conform to the current natural gas installation code, CAN 1-1.1-M81, and with local codes where applicable. This appliance has been design-certified according to ANSI Z21.1b-201 latest edition. A statement of the maximum gas supply pressure in accordance with the inlet pressure rating of the gas appliance pressure regulator is supplied.
 - **IMPORTANT:** Leak testing of the appliance must be conducted according to the manufacturer's instructions.
- The appliance should be connected to the supply line with a 1/2" or 3/4" (depending on model) metal gas line or a certified flexible type stove connector. To prevent gas leaks, put an approved sealing compound that is resistant to liquefied petroleum gases on all threaded connections.

BEFORE INSTALLATION

GAS SUPPLY

NATURAL GAS:

- This appliance is designed for use with natural gas or, after proper conversion, for use with liquid propane gas.
- This appliance is factory set for use with natural gas. The model/serial rating plate has information on the types of gas that can be used.

LIQUID PROPANE GAS:

- Conversions must be done by a qualified service technician. Go to page 25 for liquid propane conversion instructions.
- Do not attempt to convert the appliance from the gas specified on the model/serial rating plate for use with a different gas without consulting the local gas company.

GAS REQUIREMENTS - ALL MODELS	
NATURAL GAS	WC
Supply Pressure	5" (12.5 mb)
Minimum Line Pressure	7" (17.5 mb)
Maximum Regulator Pressure	14" (34.9 mb), 0.5 psi (3.5 kPa)
LIQUID PROPANE GAS	WC
Supply Pressure	10" (25 mb)
Minimum Line Pressure	11" (27.4 mb)
Maximum Regulator Pressure	14" (34.9 mb), 0.5 psi (3.5 kPa)

BEFORE INSTALLATION

GAS CONNECTIONS

- **IMPORTANT:** Do not apply pressure directly to the appliance manifold pipe when tightening supply connections. The manifold pipe should be held securely at the pressure regulator to prevent twisting. Hold the pressure regulator with a wrench during tightening, or the manifold pipe may be twisted and split and cause a dangerous leak.
- **NOTE:** Check all piping connections on the unit for leaks. Use a soap solution, 75% water, 25% dish soap. It is possible for connections made at the factory to leak, due to vibration encountered in shipping. Make certain you have checked them all, and repair any connections that leak.



NEVER use an open flame to check for leaks from gas connections. Checking for leaks with a flame may result in a fire or explosion.

- The appliance must be isolated from the gas supply piping system by closing its individual manual shut-off valve during any pressure testing of the gas supply piping system at test pressures equal to or less than 1/2 psig (3.5 kPa).

GAS LINE SHUT-OFF VALVE

- To reduce the possibility of gas leaks, apply Teflon tape or a thread compound approved for use with liquid propane or natural gases to all threaded connections.
- Install an agency-approved, properly-sized manual gas line shut-off valve in the gas line in an easily accessed location outside the range in the gas piping external to the appliance for the purpose of turning on or shutting off gas to the appliance.
- This valve is not shipped with the appliance and must be provided by the installer.
- For SRT30 and SRT36 series ranges, install a male 1/2" flare union adapter to 1/2" FPT internal thread at the regulator's inlet.
- For PCRT30/PSRT30, PCRT36/PSRT36, and PCRT48/PSRT48/SRT48 series ranges, install a male 3/4" flare union adapter to the 3/4" FPT internal thread at the regulator's inlet.
- Use a wrench on the regulator fitting to avoid damage.
- Install a male 1/2" or 3/4" flare union adapter to the MPT internal thread of the manual shut-off valve, taking care to secure the shut-off valve to keep it from turning.

BEFORE INSTALLATION

ELECTRICAL SAFETY



ELECTRIC SHOCK HAZARD

DANGER

- Failure to follow these instructions can result in death, fire, or electrical shock.
- Any additions, changes, or conversions required to properly operate this appliance must be made by a qualified service technician in accordance with the manufacturer's instructions and all codes and requirements of the local governing authority.
- Failure to follow the instructions could result in serious injury or property damage. The qualified agency performing this work assumes responsibility for the conversion.
- DO NOT operate this appliance using a 2-prong adapter. DO NOT use an extension cord. If a 2-prong wall receptacle is the only available outlet, it is the responsibility of the consumer to have it replaced with a properly grounded 3-prong wall receptacle installed by a qualified electrician.
- Using an outlet with a ground fault circuit interrupter (GFCI) is not recommended.
- Severe shock or damage to the range may occur if the appliance is not installed by a qualified installer or electrician.
- The power supply must be the correct polarity. Reverse polarity will result in continuous sparking of the electrodes, even after flame ignition. If unsure whether the power supply has the correct polarity or is properly grounded, have it checked by a qualified electrician.

ELECTRICAL REQUIREMENTS - ALL MODELS	
Electrical Supply	120 VAC, 60 Hz
Circuit	15-amp dedicated circuit
Total Amps	3



WARNING

Ranges are equipped with a 3-prong NEMA 5-15P plug for your protection against shock hazard and should be plugged directly into a properly grounded receptacle. Do not cut or remove the prong from this plug.



CAUTION

Label all wires prior to disconnection when servicing controls. Wiring errors can cause improper and dangerous operation. Verify proper operation after servicing.

BEFORE INSTALLATION

INCLUDED PARTS

- Burner caps
- Burner rings
- Standard grates
- Knobs
- LPG orifices
- Pressure regulator
- AC plug

TOOLS AND ADDITIONAL PARTS NEEDED (NOT INCLUDED)

- Tape measure
- Phillips-head screwdriver
- Flat head screwdriver
- 1/8" (3 mm) flat head screwdriver
- Level
- Hand or electric drill
- Wrench or pliers
- Pipe wrench
- 15/16" (24 mm) combination wrench
- 1/8" (3 mm) drill bit
- Marker or pencil
- Pipe-joint compound resistant to LP gas
- Noncorrosive leak-detection solution
- 7 mm socket wrench or nut driver
- 10 mm socket wrench or nut driver
- Manual gas line shut-off valve
- Male 1/2" or 3/4" flare union adapter
- 1/2" or 3/4" MPT internal thread elbow



Scan to follow along with a video to review how to assemble your range top. **NOTE:** The range in the video is of a SRT36 series range, but the cooktop assembly process is the same for range top models; check your range top cover to see which elements apply to your range top.

BEFORE INSTALLATION

ADDITIONAL PARTS

- Check local codes, consult your gas supplier, and check the existing gas/electrical supply prior to beginning the installation process.
- See the “Electrical Safety” and “Gas Connection” sections of this manual for further information and guidance on the additional parts a qualified installer will need to perform this installation.

RANGE TOP PLACEMENT

- The measurements on page 17 must be used. Given dimensions are minimum clearances from combustible surfaces. For additional cabinet cut-out details, see page 20.
- Working areas adjacent to the appliance should have 18" (457 mm) minimum clearance between countertop and cabinet bottom (see diagram on page 17 for reference).
- All openings in the wall or floor where appliance will be installed must be sealed.
- A grounded electrical supply is required. See the “Electrical Supply” section on page 14 for requirements and additional safety precautions.
- Proper gas supply connection must be available. See “Gas Connection” section on pages 21–24, as well as additional gas supply requirements on page 12.
- Reference the diagram on page 17 for the appropriate locations for gas and electrical hookups. Electrical cord length for all range tops and sizes is 71" (1803 mm).
- The range top should only be installed below ducted ventilation hoods. Do not install with a downdraft ventilation system.



WARNING

The range top may not sit flush to the back wall if the gas or electrical connections are installed outside of these dimensions.



WARNING

It is the responsibility of the installer to ensure the appliance is properly adjusted at the time of installation. Situations caused by improper adjustments or improper installation are not covered under warranty.



WARNING

Items of interest to children should not be placed in cabinets above the range top. Children climbing on the range top to reach items could be seriously injured or burned.

BEFORE INSTALLATION

DIMENSIONS AND CLEARANCES

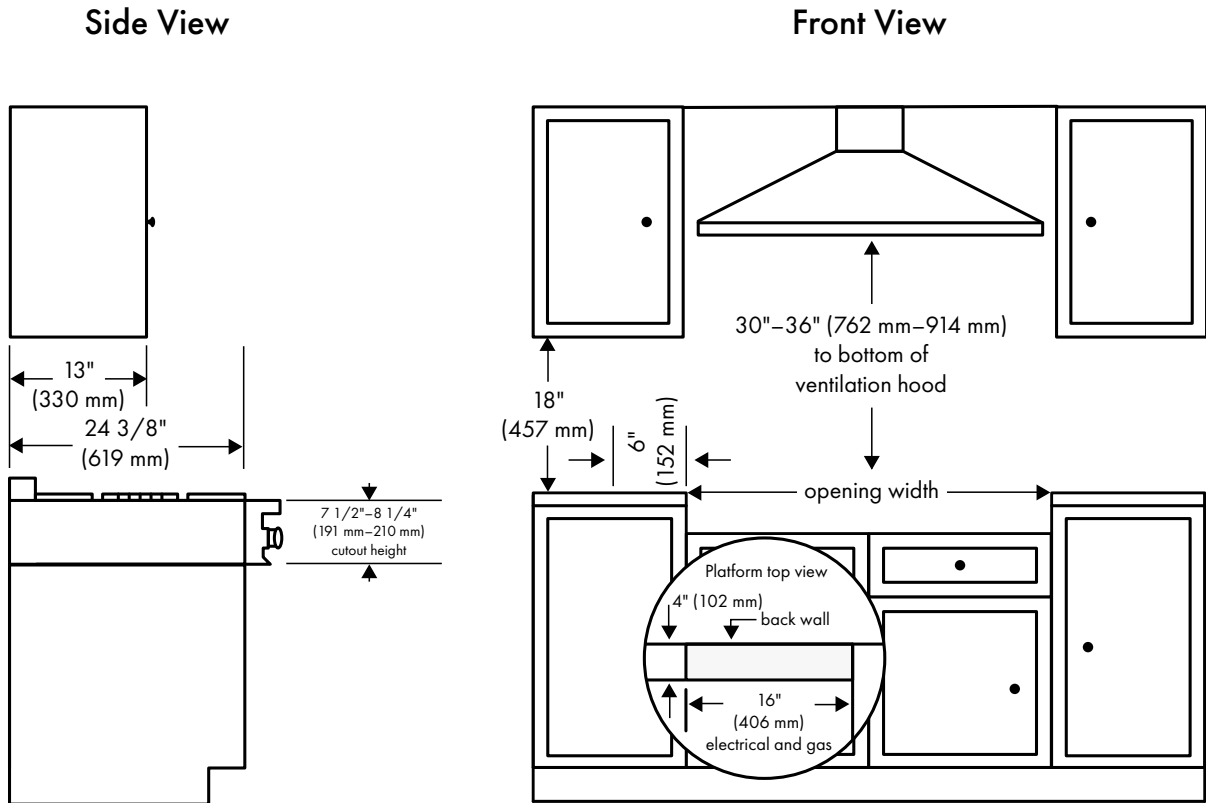

- Make sure the wall coverings, countertop and cabinets around the appliance can withstand heat up to 200 °F (93 °C) generated by the appliance.
- Cabinet opening dimensions that are shown must be used. Given dimensions are minimum clearances.
- Working areas adjacent to the range top should have 18" (457 mm) minimum clearance between countertop and cabinet bottom.

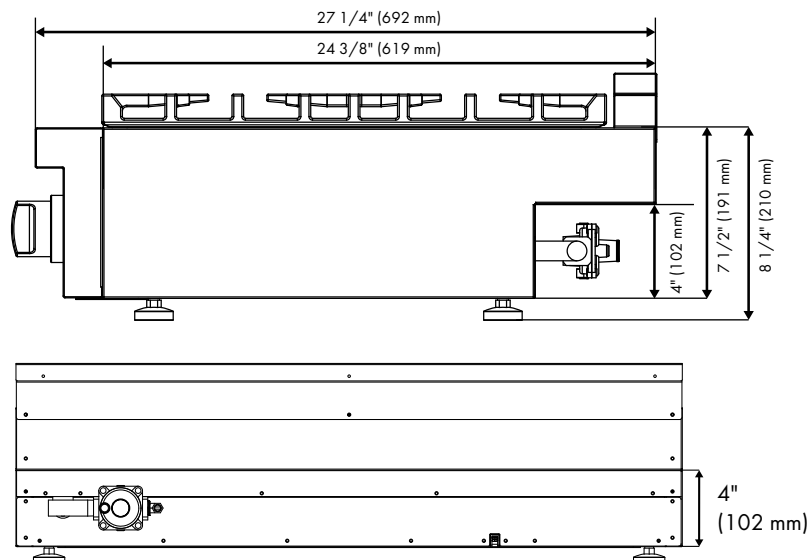

BEFORE INSTALLATION

PRODUCT SPECIFICATIONS

30" (762 mm) models:

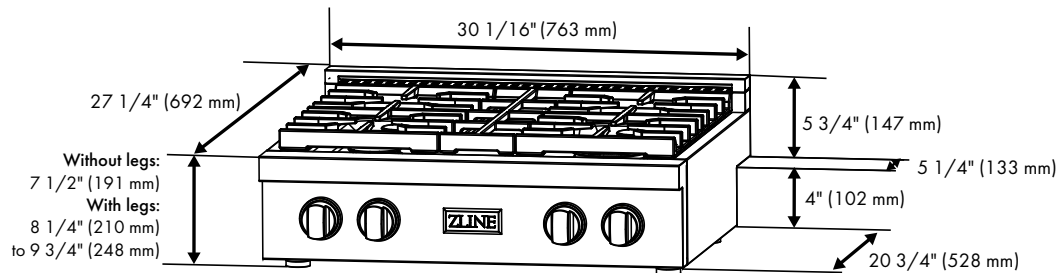

36" (914 mm) models:

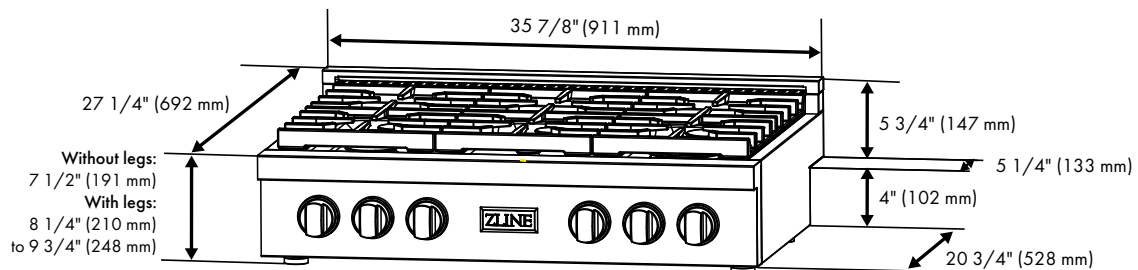

48" (1219 mm) models:

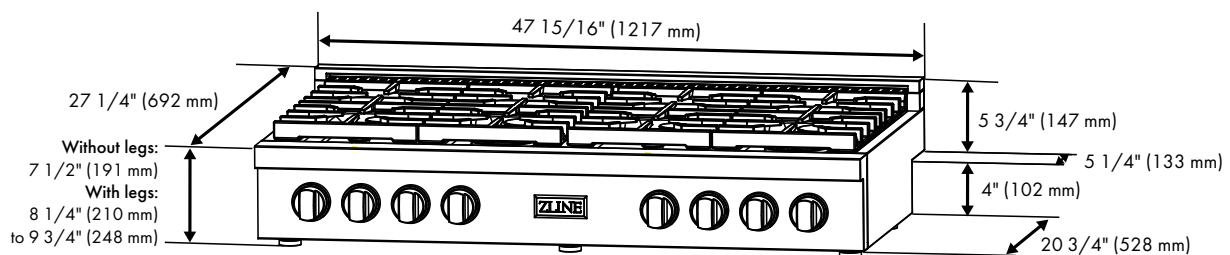

*NOTE: The legs can be adjusted by roughly 1 1/2" (38 mm) depending on your preferred height.

BEFORE INSTALLATION

RECOMMENDED CABINET CUT-OUT DIMENSIONS

Cut the opening in the countertop. To ensure accuracy, it is best to make a template for the opening. Make sure the sides are parallel and that rear and front cuts are exactly perpendicular to the sides. Observe all minimum clearances.

RANGE SERIES	WIDTH	DEPTH	HEIGHT
30" (762 mm) models	30 1/8" W (765 mm W)	24" D (minimum)–26" D (maximum)* 610 mm D (minimum)–660 mm D (maximum)*	7 1/2" H (minimum)–9 3/4" H (maximum)** 191 mm H (minimum)–248 mm H (maximum)**
36" (914 mm) models	36 1/8" W (918 mm W)		
48" (1219 mm) models	48 1/8" W (1222 mm W)		

*Depth can be a maximum of 26" (660 mm) for the front of the unit to be flush with the cabinetry.

**Height can be between 8 1/4"–9 3/4" (210 mm–248 mm) if you install the legs.



WARNING

The use of cabinets for storage above the appliance may result in a potential fire hazard. Combustible items may ignite; metallic items may become hot and cause burns. If cabinet storage is necessary, the risk can be reduced by installing a range hood that projects horizontally a minimum of 5" (127 mm) beyond the bottom of the cabinets.

BEFORE INSTALLATION

GAS RANGE TOP SPECIFICATIONS

NOTE: Minimum clearance for back wall is 0" (0 mm) with backsplash (backguard) or high shelf.

- If a range hood is installed above the range top, maintain a 30" (762 mm) minimum clearance between the range top and the bottom of the range hood.
- The range top should only be used with ducted range hoods.
- Do not install with a downdraft ventilation system.
- The range top CANNOT be installed directly adjacent to sidewalls, tall cabinets, tall appliances, or other side vertical surfaces above 36" (914 mm) high. There must be a minimum of 6" (152 mm) side clearance from the range top to such combustible surfaces above the 36" (914 mm) counter height.
- Within the 6" (152 mm) side clearance to combustible vertical surfaces above 36" (914 mm), the maximum wall cabinet depth must be 13" (330 mm) and wall cabinets within this 6" (152 mm) side clearance must be 18" (457 mm) above the 36" (914 mm) high countertop.

PREPARE CUT-OUT



WARNING

WARNING:

- Items of interest to children should not be placed in cabinets above the cooktop.
- Children climbing on the cooktop to reach items could be seriously injured.

INSTALLATION IN AN ISLAND

- **NOTE:** There must be a minimum of 6" (152 mm) clearance from rear of range top to a combustible wall. Clearances from non-combustible materials are not part of the ANSI Z21.1 scope and are not certified by CSA. Clearances to non-combustible materials must be approved by the authority having jurisdiction.
- This range top may be installed directly adjacent to existing 36" (914 mm) high base cabinets.

INSTALLATION

GAS CONNECTION

- While range tops come factory ready to operate on natural gas (NG), the appliance can be converted for use on liquid propane gas (LPG). When using this range top on liquid propane gas, the conversion must be made by a qualified installer before attempting to operate the range top on that gas.
- All gas connections must comply with national and local codes. When connecting a flexible gas line connector to the regulator on the range top, be sure to position the range top to permit connection at the manual shut off valve.



DANGER

The gas supply line must be equipped with an approved manual shut-off valve. The shut-off valve must be in an easily accessible location in the same room as the appliance. Do not block access to the shut-off valve. Be sure you know how and where to shut off the gas supply to the range top.

IMPORTANT:

- The pressure regulator located at the inlet of the appliance manifold must remain in the supply line regardless if natural gas or liquid propane gas is being used.
- The gas regulator has a clear plastic shield covering the inlet to protect against debris. Be certain this has been removed prior to connecting the supply line or coupler.
- A flexible metal appliance connector to connect the range top to the gas supply should be a maximum of 3' – 36" (914 mm) in length for easy installation.
- In Canada, flexible connectors should be single-wall metal connectors less than 6' (1829 mm) in length.

INSTALLATION

GAS CONNECTION (CONTINUED)



WARNING

EXPLOSION HAZARDS

- Please read ALL safety precautions on pages 1 – 10 before beginning installation.
- Only use a CSA-approved gas supply line.
- You must install an approved manual shut-off valve.
- Securely tighten all connections if necessary to prevent gas leakage in the appliance or supply line.
- If connected to LPG, have a qualified person make sure gas pressure does not exceed 3.5 kPa/14" W.C.P. Examples of a qualified person include licensed heating personnel, authorized gas company personnel, and authorized service personnel.
- Failure to follow these warnings can result in death, explosion, or fire.

GAS INSTALLATION STEPS

1. Shut off the main gas supply valve before removing the old cooking appliance (if applicable) and leave it off until the new hook-up has been completed. Don't forget to relight the pilots on other gas appliances when you turn the gas back on.
2. Because hard piping restricts movement of the appliance, the use of a CSA-certified flexible metal appliance connector is recommended unless local codes require a hard-piped connection. Never reuse an old connector when installing a new appliance. If the hard piping method is used, you must carefully align the pipe. To prevent gas leaks, use pipe joint compound resistant to gas on all male external pipe threads.
3. Use a flexible gas line to connect to the 1/2" or 3/4" (depending on model) regulator fitting, located on the bottom left corner underneath the appliance (when facing the rear of the range).
4. When all connections have been made, be sure all appliance controls are in the off position and turn on the main gas supply valve. Check for gas leaks by using a 75% water, 25% dish washing soap solution. If a gas leak occurs, shut off gas immediately, tighten all connections, and retest for leaks.

INSTALLATION

GAS CONNECTION (CONTINUED)



Only connect the gas line through the 1/2" or 3/4" (depending on model) fitting on the side of the pressure regulator, as outlined in the diagram on the following page. DO NOT attempt to connect gas by removing the regulator access cap — the regulator access cap is only used for liquid propane conversions and must stay on at all times.

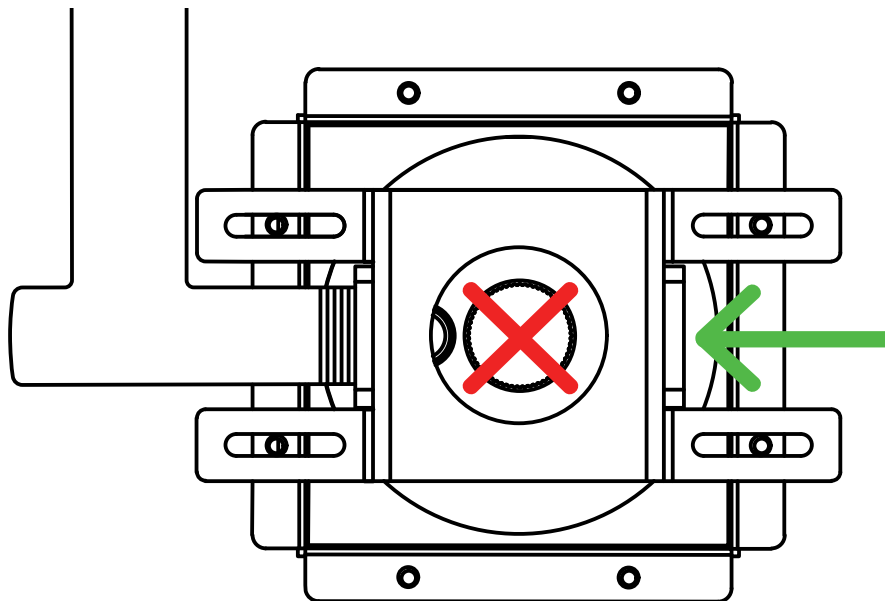

Refer to this diagram for proper gas hookup on the right side of the regulator.

IMPORTANT: Regulator access cap is for LP conversion and pressure adjustment only. Gas hookup does not go here. Hand tighten regulator access cap only.

INSTALLATION

GAS CONNECTION (CONTINUED)



SAFETY AND EXPLOSION HAZARDS

DANGER

- Check alignment of control knob valves. A misalignment could result in a gas leak at the valve.
- The below figure demonstrates the proper gas hook-up flow for all range tops. The pressure regulator is located at the bottom right corner when facing the unit (bottom left corner when facing it from behind).
- **NOTE:** The pressure regulator and cap come pre-installed on the unit; the other parts in the figure below are not supplied and are the responsibility of the customer to obtain for a qualified installer to install to ensure a safe and effective gas hook-up.

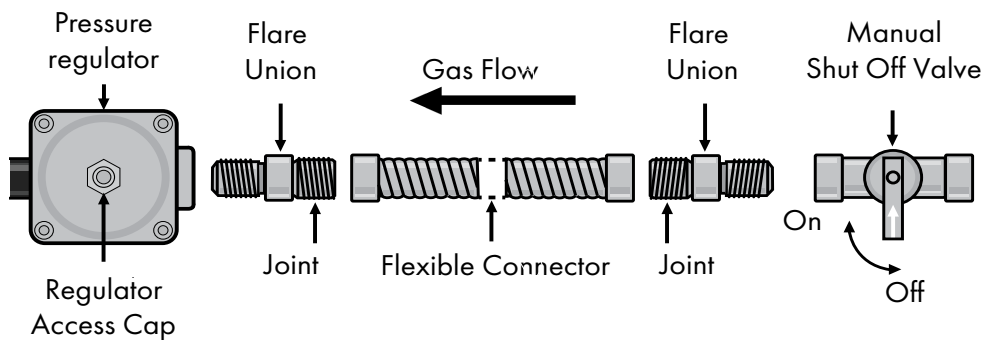

INSTALLATION

LIQUID PROPANE GAS CONVERSION PROCEDURE (OPTIONAL)



CAUTION

CAUTION: The gas supply shall be shut off prior to disconnecting the electrical power, before proceeding with the conversion.



CAUTION

CAUTION: Before proceeding with the conversion, shut off the gas supply to the appliance prior to disconnecting the electrical power.



ATTENTION

Attention : Avant de procéder à la conversion, fermer d'abord la source d'alimentation en gaz de l'appareil, puis débrancher le cordon d'alimentation en électricité.

IMPORTANT:

- A kit for converting to liquid propane gas is supplied with your appliance. The kit is marked:
 - **SRT30 series ranges:** "SDP-LPOK30 Liquid Propane Gas (LPG) Orifice Kit for CDR30-A1/MDR30-A1/SDR30-A1/SRT30 Series"
 - **SRT36 series ranges:** "SDP-LPOK36 Liquid Propane Gas (LPG) Orifice Kit for CDR36-A1/MDR36-A1/SDR36-A1/SRT36 Series"
 - **SRT48 series ranges:** "SDP-LPOK48 Liquid Propane Gas (LPG) Orifice Kit for CDR48-A1/MDR48-A1/SDR48-A1/SRT48 Series"
- **PCRT30/PSRT30 series range tops:** "ZLINE Liquid Propane Gas (LPG) Orifice Kit for PCRT30-A1/PMDR30-A1/PSRT30-A1/PCDR30-A1/PSDR30-A1 Series (PSDP-LPOK30)"
- **PCRT36/PSRT36 series range tops:** "ZLINE Liquid Propane Gas (LPG) Orifice Kit for PCRT36-A1/PMDR36-A1/PSRT36-A1/PCDR36-A1/PSDR36-A1 Series (PSDP-LPOK36)"
- **PCRT48/PSRT48 series range tops:** "ZLINE Liquid Propane Gas (LPG) Orifice Kit for PCRT48-A1/PMDR48-A1/PSRT48-A1/PCDR48-A1/PSDR48-A1 Series (PSDP-LPOK48)"

INSTALLATION

LIQUID PROPANE CONVERSION (CONTINUED)



WARNING

IMPORTANT SAFETY MEASURES

- The conversion must be performed by a qualified service technician in accordance with the kit instructions and all local codes and requirements.
- When the appliance is converted for liquid propane gas, the LPG gas supply is required to provide a minimum of 2.5 kPa/10" W.C.P. to a maximum of 3.5 kPa/14" W.C.P. to the appliance regulator.

INSTALLATION

LIQUID PROPANE CONVERSION (CONTINUED)



WARNING

This conversion kit shall be installed by a qualified service agency in accordance with the manufacturer's instructions and all applicable codes and requirements of the authority having jurisdiction. If the information in these instructions is not followed exactly, a fire, explosion or production of carbon monoxide may result causing property damage, personal injury or loss of life. The qualified service agency is responsible for the proper installation of this kit. The installation is not proper and complete until the operation of the converted appliance is checked as specified in the manufacturer's instructions supplied with the kit.



AVERTISSEMENT

Cet ensemble de conversion doit être installé par un organisme de service qualifié, conformément aux directives du fabricant ainsi qu'à tous les codes applicables et à toutes les exigences des autorités compétentes. Si les directives ne sont pas suivies à la lettre, un incendie, une explosion ou une émission de monoxyde de carbone pourrait se produire et entraîner des dommages matériels et des blessures graves ou mortelles. L'organisme de service qualifié est responsable de l'installation appropriée de cet ensemble de conversion. L'installation n'est pas considérée adéquate et complète tant que le fonctionnement de l'appareil converti n'a pas été vérifié, conformément aux directives du fabricant fournies avec l'ensemble de conversion.

INSTALLATION

LIQUID PROPANE CONVERSION (CONTINUED)

SRT SERIES RANGES - CHECKING PRESSURE

Manifold pressure should be checked on the range top by the technician using their own manometer and a ZLINE-provided test point adapter with tubing as outlined in below (the figure shows an SRT36 series range; the procedure is the same for all models, with the exception of PCRT/PSRT series models):

By hand, remove the burner spread and burner cap from the rear left or front left burner on the range top.

1. Using a 7 mm nut driver or wrench, remove the gas orifice from the bottom of the burner and mount the test point adapter (see figure below).
2. Turn the rear left or front left burner control knob to the "HI" position.
3. Press in the knob and, while keeping it pressed, check the manifold pressure with the manometer:
 - Natural gas requires 1.2 kPa/5" W.C.P., while liquid propane gas requires 2.7 kPa/11" W.C.P.
 - Incoming line pressure upstream from the regulator must be 0.25 kPa/1" W.C.P. higher than the manifold pressure in order to check the regulator.
 - The regulator used on this range top can withstand a maximum input pressure of 1/2 psi (3.5 kPa/14" W.C.P.). If the line pressure is in excess of that amount, a step-up regulator will be required.



For all range tops, do not perform the pressure test on the dual function burners, as this will not allow for proper results. Only perform the test on one of the burners on the far left side of the range top.

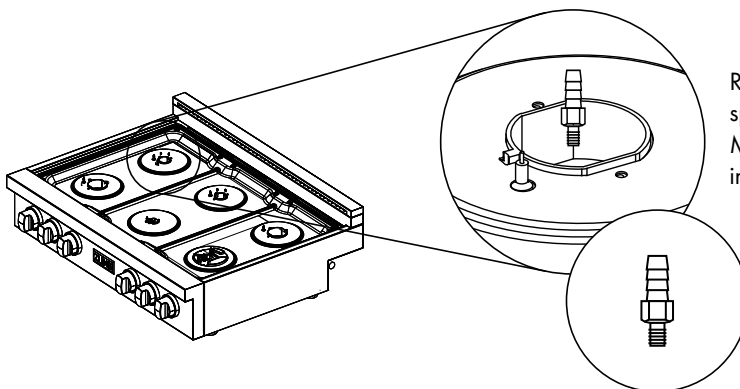

Remove the burner spread and burner cap. Mount test point adapter into orifice hole.

NOTE: If the test point adapter or tubing was not included with your range top's Liquid Propane Gas Orifice Kit, please contact ZLINE Customer Service at 1-614-777-5004.

INSTALLATION

LIQUID PROPANE CONVERSION (CONTINUED)

PCRT30/PSRT30 & PCRT36/PSRT36 SERIES RANGES - CHECKING PRESSURE

1. Ensure gas and electrical supply is turned off.
2. Using a Philips head screwdriver, remove the 4 screws holding the protective cover from the regulator.
3. Using a Philips head screwdriver, remove the screw from the regulator test point.
4. Place the provided 9 mm plastic tubing over the regulator test point, ensuring that it is a tight fit and there are no leaks.
5. Connect the tube to the test point on your manometer.
6. Turn on the manometer and set the unit of measurement to water columns.
7. Turn on the gas supply to the range.
8. Record the pressure measurement.
 - The recommended pressure for natural gas is 7".
 - The recommended pressure for liquid propane is 11".
9. Turn off the gas supply.
10. Remove the plastic tube from the regulator test point.
11. Using a small Philips head screwdriver, reinstall the screw into the regulator test point.
12. Turn on the gas and electrical supply to the range.

INSTALLATION

LIQUID PROPANE CONVERSION (CONTINUED)

PCRT48/PSRT48 SERIES RANGES - CHECKING PRESSURE

1. Ensure gas and electrical supply is turned off.
2. Using a #5 Allen wrench, remove the screw from the test point.
3. Install the provided test point adapter using a wrench, be sure not to cross thread or over tighten.
4. Connect the provided 7 mm plastic tube to the test point adapter.
5. Turn on the manometer and set the unit of measurement to water columns.
6. Turn on the gas supply to the range.
7. Record the pressure measurement.
 - The recommended pressure for natural gas is 7".
 - The recommended pressure for liquid propane is 11".
8. Turn off the gas supply.
9. Remove the plastic tube and test point adapter from the regulator.
10. Using a #5 Allen wrench, reinstall the screw into the regulator test point ensuring that it does seal.
11. Turn on the gas and electrical supply to the range.

INSTALLATION

LIQUID PROPANE CONVERSION (CONTINUED)



Disconnect electrical power to the appliance before servicing. Failing to do so may result in death, fire, or electrical shock.

ADJUSTING THE REGULATOR PRESSURE

- Shut off the gas supply to the appliance by closing the manual shut-off valve (see images below). Purge the gas line by pushing in the range knobs several times to ensure no more gas is flowing through the system.

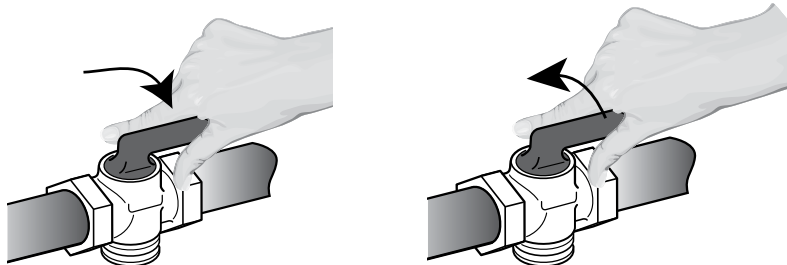

- Unscrew the regulator access cap by hand or with a proper-sized pipe wrench.
- Remove the regulator pin by pulling it out.

INSTALLATION

LIQUID PROPANE CONVERSION (CONTINUED)

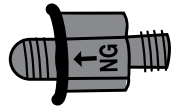

30" and 36" (762 mm and 914 mm) models



48" (1219 mm) models

- Unscrew the retainer pin, reverse it, and screw back into the regulator cap as outlined in the figures above and below.
 - For 30" and 36" (762 mm and 914 mm) models, pin is not attached to a spring.
 - For 48" (1219 mm) models, the pin is attached to a spring. When reversing the pin, ensure the spring is snug when tightening.

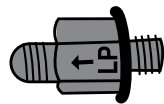

30" and 36" (762 mm and 914 mm) models



48" (1219 mm) models

- Screw the regulator access cap back into the regulator and re-attach it to the nipple and flare union as shown. **DO NOT** over-tighten (see figures below).

NOTE: The pressure regulator and cap come pre-installed on the unit; the other parts in the figure at bottom right are not supplied and are the responsibility of the customer to obtain for a qualified installer to install to ensure a safe and effective gas hook-up.

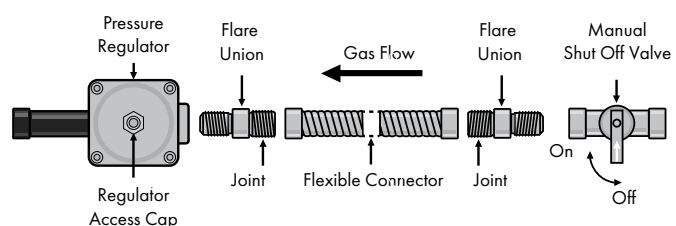
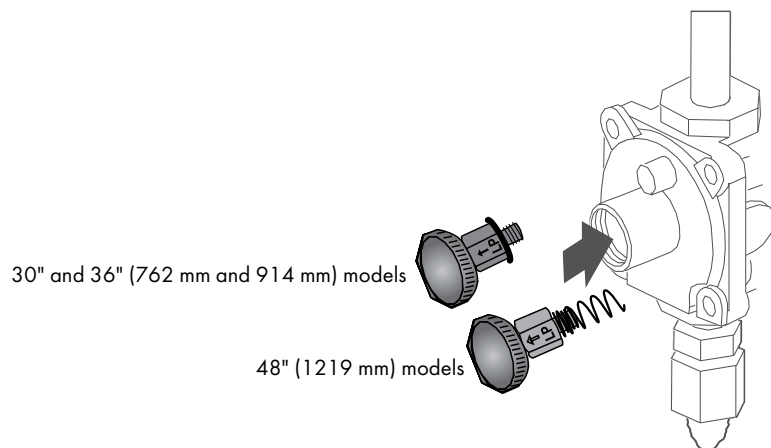

INSTALLATION

LIQUID PROPANE CONVERSION (CONTINUED)

CHANGING BURNER ORIFICES

- After removing the burner grates, burner caps, and burner spreads, use a 7 mm nut driver or wrench to remove the existing natural gas orifices as outlined in the figure below. Carefully read and observe each orifice label for correct location.
- **IMPORTANT:** DO NOT force or over-tighten orifices, as doing so may damage the burner base and affect the flame.
- **NOTE:** Not indicated in the images below are dual burner layouts. Each dual burner includes 3 orifices — 1 in the middle, like below, and 2 on the side. Use a 7 mm wrench to remove the side orifices.

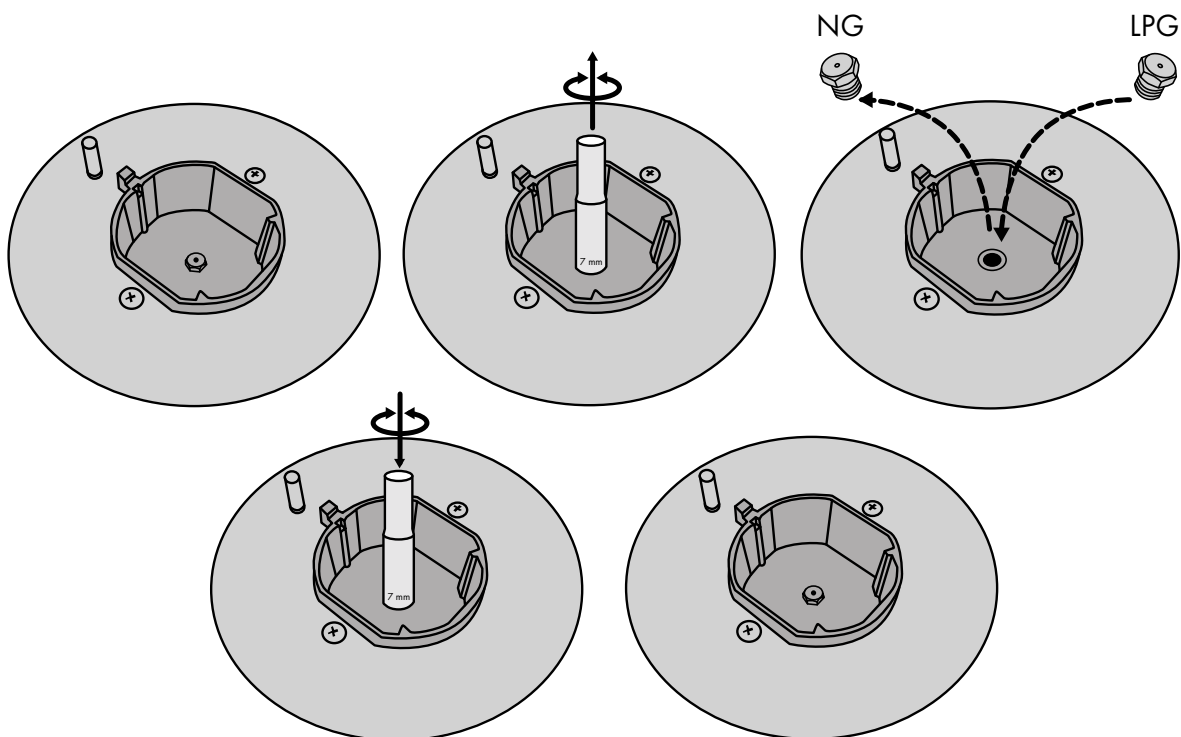

WARNING

Save the orifices removed from the appliance for future use. You should use the same process to re-convert to natural gas. Take extra care when handling steel parts.



WARNING

Conserver les orifices retirés de l'appareil en vue d'une utilisation ultérieure.



WARNING

Care should be taken when removing and replacing gas components. Use proper support to prevent damage to components.

INSTALLATION

LIQUID PROPANE CONVERSION (CONTINUED)

ORIFICE NUMBERS

INSTALLATION TIP: To prevent any mistakes during the conversion, remove ALL existing natural gas orifices first before replacing them with the LPG orifices.

IMPORTANT: Each orifice has a number indicating its flow diameter printed on the body. Install the proper orifice in the exact locations as noted in the illustrations and table below for SRT30 series range tops. Note the dual burner includes 3 orifices to remove/replace — 1 in the middle and 2 on the side.

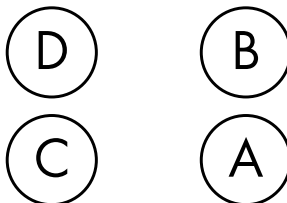
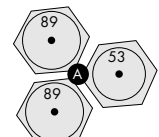
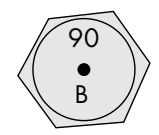
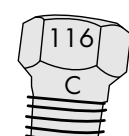
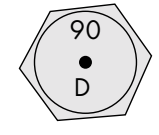
SRT30 SERIES ORIFICES				
BURNER LAYOUT	BURNER	PICTURE	NG	LPG
	A		1.36 (2) + 0.73	0.89 (2) + 0.53
	B		1.36	0.90
	C		1.79	1.16
	D		1.36	0.90

INSTALLATION

LIQUID PROPANE CONVERSION (CONTINUED)

IMPORTANT: Install the proper orifice in the exact locations as noted in the illustrations and table below for SRT36 series range tops. Note the dual burner includes 3 orifices to remove/replace — 1 in the middle and 2 on the side.

SRT36 SERIES ORIFICES				
BURNER LAYOUT	BURNER	PICTURE	NG	LPG
	A		1.36 (2) + 0.73	0.89 (2) + 0.53
	B		1.57	1.00
	C		1.07	0.74
	D		1.36	0.90
	E		1.79	1.16
	F		1.36	0.90

INSTALLATION

LIQUID PROPANE CONVERSION (CONTINUED)

IMPORTANT: Install the proper orifice in the exact locations as noted in the illustrations and table below for SRT48 series range tops. Note the dual burner includes 3 orifices to remove/replace — 1 in the middle and 2 on the side.

SRT48 SERIES ORIFICES				
BURNER LAYOUT	BURNER	PICTURE	NG	LPG
	A		1.36 (2) + 0.73	0.89 (2) + 0.53
	B		1.57	1.00
	C		1.07	0.74
	D		1.36	0.90
	E		1.36 (2) + 0.73	0.89 (2) + 0.53
	F		1.57	1.00
	G		1.07	0.74
	H		1.36	0.90

INSTALLATION

LIQUID PROPANE CONVERSION (CONTINUED)

IMPORTANT: Install the proper orifice in the exact locations as noted in the illustrations and table below for PCRT30/PSRT30 series ranges. Note the dual burner includes 3 orifices to remove/replace – 1 in the middle and 2 on the side.

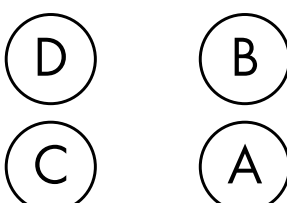
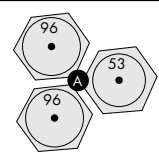
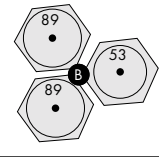
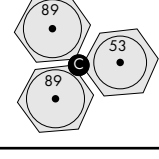
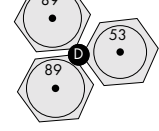
PCRT30/PSRT30 SERIES ORIFICES				
BURNER LAYOUT	BURNER	PICTURE	NG	LPG
	A		1.50 (2) + 0.75	0.96 (2) + 0.53
	B		1.36 (2) + 0.73	0.89 (2) + 0.53
	C		1.36 (2) + 0.73	0.89 (2) + 0.53
	D		1.36 (2) + 0.73	0.89 (2) + 0.53

INSTALLATION

LIQUID PROPANE CONVERSION (CONTINUED)

IMPORTANT: Install the proper orifice in the exact locations as noted in the illustrations and table below for PCRT36/PSRT36 series ranges. Note the dual burner includes 3 orifices to remove/replace – 1 in the middle and 2 on the side.

PCRT36/PSRT36 SERIES ORIFICES				
BURNER LAYOUT	BURNER	PICTURE	NG	LPG
<div style="display: flex; justify-content: space-around; align-items: center;"> <div style="text-align: center;"> <p>(F)</p> <p>(E)</p> </div> <div style="text-align: center;"> <p>(D)</p> <p>(C)</p> </div> <div style="text-align: center;"> <p>(B)</p> <p>(A)</p> </div> </div>	A		1.50 (2) + 0.75	0.96 (2) + 0.53
	B		1.36 (2) + 0.73	0.89 (2) + 0.53
	C		1.36 (2) + 0.73	0.89 (2) + 0.53
	D		1.36 (2) + 0.73	0.89 (2) + 0.53
	E		1.50 (2) + 0.75	0.96 (2) + 0.53
	F		1.36 (2) + 0.73	0.89 (2) + 0.53

INSTALLATION

LIQUID PROPANE CONVERSION (CONTINUED)

IMPORTANT: Install the proper orifice in the exact locations as noted in the illustrations and table below for PCRT48/PSRT48 series ranges. Note the dual burner includes 3 orifices to remove/replace – 1 in the middle and 2 on the side.

PCRT48/PSRT48 SERIES ORIFICES				
BURNER LAYOUT	BURNER	PICTURE	NG	LPG
	A		1.50 (2) + 0.75	0.96 (2) + 0.53
	B		1.36 (2) + 0.73	0.89 (2) + 0.53
	C		1.36 (2) + 0.73	0.89 (2) + 0.53
	D		1.36 (2) + 0.73	0.89 (2) + 0.53
	E		1.36 (2) + 0.73	0.89 (2) + 0.53
	F		1.36 (2) + 0.73	0.89 (2) + 0.53
	G		1.50 (2) + 0.75	0.96 (2) + 0.53
	H		1.36 (2) + 0.73	0.89 (2) + 0.53

INSTALLATION

INSTALLING PARTS

BURNER SPREADS AND CAPS

- After unpacking the range top, set the cast iron grates aside and remove the burner spreads and caps from the parts storage location under the grates.
- Place each spread on the appropriate burner by making sure the hole fits over the white metal electrode spark tip. Next, place each burner cap on top until snug.
- Burners may only partially ignite or not light at all if burner spreads (B) or caps (A) are not properly installed, as outlined below:

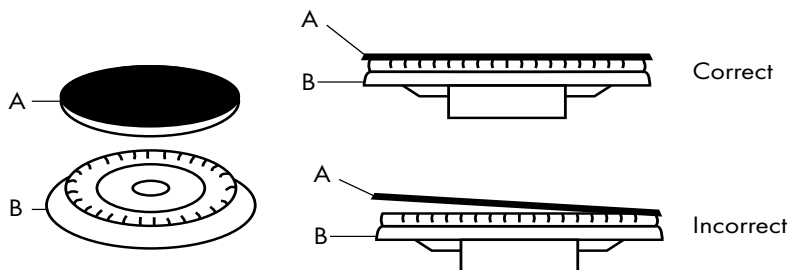

CAST IRON GRATES

- Next, place the cast iron grates on top the range top, using care to not scratch the porcelain cooktop. There are rubber feet on the bottom of each grate and slots on the cooktop where each grate fits into.
- 48" (1219 mm) models come with an enameled reversible cast iron griddle that can be placed vertically (front to back) on any of the four cast iron grates. Do not place the griddle horizontally (left to right) across multiple grates.

INSTALLATION

SRT30 SERIES RANGE TOP KNOBS (4 TOTAL)

- To install knobs, hold each in the "OFF" position and push straight onto the single valves protruding from the front of the cooktop, as outlined at right:

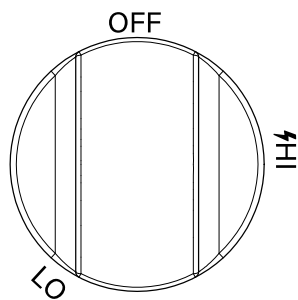
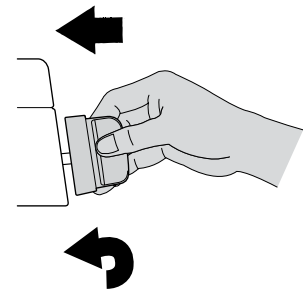

Burner Knobs (3)

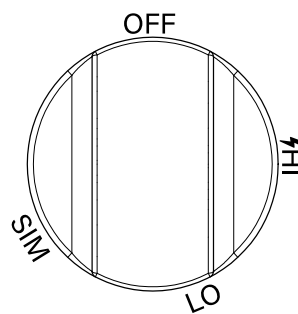

Dual Function Knob (1)



WARNING

The SRT30 and SRT36 series range tops come with 1 brass dual function burner, and the SRT48 series range top includes 2 brass dual function burners. The burner knobs for those include a "SIM" setting, as outlined in the images below.

SRT36 SERIES RANGE TOP KNOBS (6 TOTAL)

The dual function knob goes on the far right side of the range top.

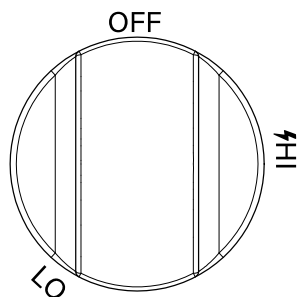

Burner Knobs (5)

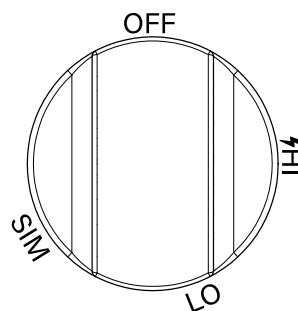

Dual Function Knob (1)

INSTALLATION

SRT48 SERIES RANGE TOP KNOBS (8 TOTAL)

Individual burner knobs go on each side.

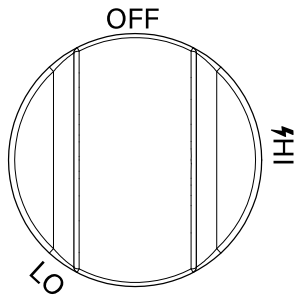

Burner Knobs (6)

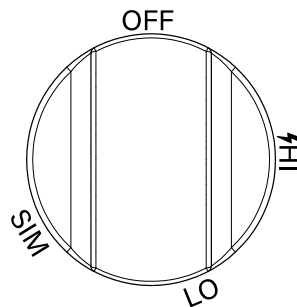

Dual Function Knobs (2)

PCRT30/PSRT30, PCRT36/PSRT36, & PCRT48/PSRT48 SERIES RANGE TOP KNOBS

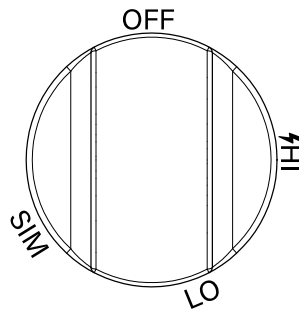

Dual Function Knob

INSTALLATION

MANUAL FLAME ADJUSTMENT

SRT SERIES MODELS

- Each range includes a flame adjustment feature if burners experience irregular flame sizes or are too yellow or orange in color. Ranges are designed to ensure flames are set at appropriate levels. Should an adjustment be needed, follow these steps:
- Light one burner at a time and set it to the lowest position. Next, remove the knob by firmly and carefully pulling it straight out.
- Inside each burner is an adjustment valve. Using a 2 mm x 50 mm flathead screwdriver, locate the adjustment screw (see diagram — the screw is on the right) and turn the screwdriver to the right or left until the flame is adjusted to the desired minimum. Use a flashlight if it's difficult to see the adjustment screw.
- Make sure the flame does not go out when switching quickly from the HI to the LO position. **NOTE:** The high flame setting cannot be adjusted to be lower.
- **NOTE:** For the dual burner knobs, there are 2 screws to adjust if needed — 1 for the inner ring and 1 for the outer ring. These screws are located on the left side of the adjustment valve.

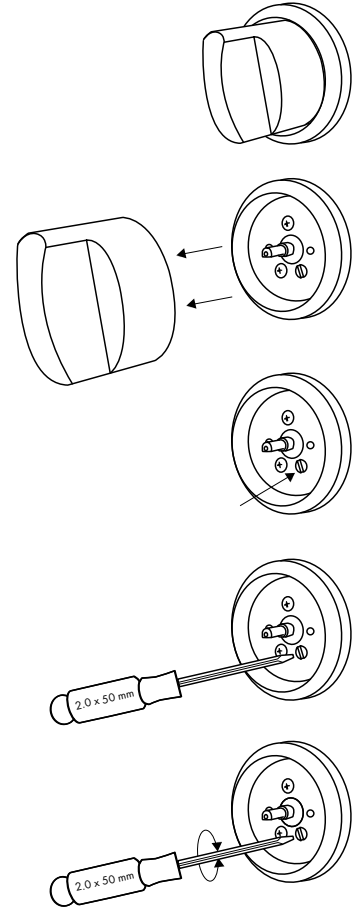

Scan to follow along with a video.

INSTALLATION

MANUAL FLAME ADJUSTMENT

PCRT/PSRT SERIES RANGES

- Each range includes a flame adjustment feature if burners experience irregular flame sizes or are too yellow or orange in color. Ranges are designed to ensure flames are set at appropriate levels. Should an adjustment be needed, follow these steps:
- Light one burner at a time and set it to the lowest position. Next, remove the knob by firmly and carefully pulling it straight out.
- Inside each burner are two adjustment valves. Using a 2 mm x 50 mm flathead screwdriver, locate the adjustment screws (see diagram — the screws are on the left) and turn the screwdriver to the right or left until the flame is adjusted to the desired minimum. Use a flashlight if it's difficult to see the adjustment screws.
- Make sure the flame does not go out when switching quickly from the HI to the LO position. **NOTE:** The high flame setting cannot be adjusted to be lower.

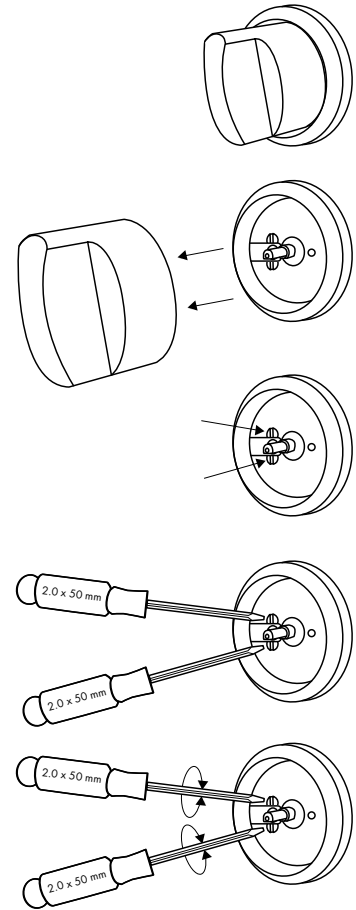

Scan to follow along with a video.

INSTALLATION

FINISH INSTALLATION

1. After your gas connection is properly installed, plug the range top's NEMA 5-15 electrical cord into a properly grounded 3-prong outlet.



The electrical socket must be easily accessible with the appliance installed. In all cases, the power supply lead must be positioned so that it does not reach a temperature of 122 °F (50 °C) above the room temperature at any point.

2. Slide the range top into place.

FINAL CHECKLIST

- Check that the white spark tip for each burner fits into the hole in each burner spread.
- Check that each burner cap is snug and level on the burner spread.
- Check that all grates are on the cooktop, being careful to not scratch the burner caps, burner spreads, or porcelain cooktop.
- Using a level, check that the range is even with the counter top and level, or uneven baking may result.
- When all connections have been made, check that all range controls are in the "OFF" position and turn on the main gas supply valve.



It may take a few minutes before gas will freely flow through the unit, so it could take a few attempts to light the cooktop. Refer to the User Manual for how to operate cooktop burners and adjust flame settings.

NOTE: The installer should leave these instructions with the consumer who should retain for local inspectors' use and for future reference. Installers and consumers should refer to the User Manual for additional safety measures, operation tips, and troubleshooting.

WARRANTY

COVERAGE

ZLINE Kitchen and Bath (“ZLINE”) range tops have a one year parts and service warranty and a limited lifetime warranty on burners, which includes parts and labor for spark tips.

ZLINE warranty periods begin from the original date of product delivery and solely cover the original purchaser of the product, delivered new and in its original carton. The limited warranty covers all parts and labor for necessary repairs if any part of the product, or the product itself, proves to be defective in materials or workmanship. The product must be deemed serviceable via troubleshooting with the ZLINE Customer Experience team. All service on ZLINE products under warranty must be performed by ZLINE-approved and ZLINE-certified service providers unless otherwise specified by ZLINE. Service will be provided during normal business hours. Products must be unobstructed and accessible to the service provider at the time of service. ZLINE’s liability is limited to the original purchase price of the product. Additional injuries, losses, damages, or other inconveniences caused by product malfunction or defects in materials are not covered under the terms of this warranty.

TERMS

ZLINE warranties apply only to the original purchaser of a ZLINE product installed for normal residential use. This is defined as a single-family, residential dwelling in a non-commercial setting. Any warranty claim stemming from installation, operation, or any other use within a commercial setting is not covered under this limited warranty. Commercial settings include, but are not limited to: schools, churches, hotels, restaurants, vacation rentals such as Airbnb, daycare centers, private clubs, fire stations, common areas in multi-family dwellings, nursing homes, food service locations, and institutional food service locations such as hospitals or correctional facilities.

This warranty is non-transferable and will not under any circumstance be extended based on the date of installation — the warranty period takes effect from the date of delivery and only covers the original purchaser. The warranty applies only to products installed in the contiguous United States and the District of Columbia. Failure to secure certified warranty service per these terms will result in a forfeiture of the remaining warranty. Out-of-pocket payments will not be reimbursed unless prior approval is received from ZLINE and/or ZLINE-certified service contract partners. Unapproved out-of-pocket payments for service will not be reimbursed. All warranty procedures must be followed to maintain warranty coverage.

WARRANTY

If a product qualifies within the service window provided under these warranty terms, and ZLINE is unable to repair the product or a defective part of the product after a reasonable number of attempts, ZLINE reserves the right to offer to replace the defective part or the product or provide the original purchaser a full refund of the purchase price of the product (not including installation, removal, or other charges that were not included in the original purchase price). The original purchaser of the product must provide the original proof of purchase, including the purchase date, when filing a claim to obtain replacement parts, service, or refunds. Additionally, the original purchaser of the product must provide the serial number of the product when filing a claim to obtain replacement parts, service, or refunds.

This warranty shall not apply to any ZLINE product in which the original factory serial number has been removed, altered, or cannot be readily determined for any reason. Further, ZLINE is not responsible for damage resulting from, but not limited to: shipment, delivery, or improper installation; negligence or improper maintenance, misuse, or abuse of the product; unauthorized alteration, modification, or tampering with the product; accident, fire, floods, pest infestations, pandemics, natural disasters, or any other unpreventable or unexplained acts of nature, commonly referred to as "acts of God"; flare-up fires or damages caused by improper electric supply, electrical line current, voltage, or power surges; and service to correct installation not in accordance with the instructions contained in ZLINE's product manuals and/or with local government codes.

This warranty does not apply to aesthetic damage, scratches, or natural wear caused by normal use; second-hand, open box products, or products purchased from an unauthorized retailer; improper liquid propane gas conversion or damage related to improper liquid propane gas conversion; burner flame adjustments or related complaints; corrections regarding normal adjustments or settings or local gas supply issues resulting in low pressure or other issues; damages or issues stemming from alteration or tampering with the range top, including, but not limited to, painting any portion of the product's interior or exterior and cutting the supplied power cord to manually hardwire the product; and service for gas pressure issues related to installation at high altitudes. A high-altitude pressure regulator must be sourced by the customer.

WARRANTY

In the event service is dispatched, and it is discovered that the reported issue is not covered under warranty based on the disclaimers above, the customer will be responsible for all service fees. Failure to pay these fees will result in the forfeiture of remaining warranty coverage.

Information contained within ZLINE's installation and user manuals, in addition to product information included on ZLINE's website and all related digital listings, do not cover every possible condition and situation that may occur during the installation or operation of ZLINE products.

ZLINE reserves the right to make changes at any time to its products when considered safe, necessary, and useful. Always check the ZLINE website for the most up-to-date version of its product manuals: www.zlinekitchen.com/pages/manuals.

Do not install or operate any ZLINE product if it has missing or broken parts or if it arrives damaged due to shipping. If ZLINE products arrive damaged, contact ZLINE Customer Experience at 1-614-777-5004 for help. Failure to report a damaged appliance prior to installation or operation may void the warranty.

ZLINE disclaims responsibility for damage or injury caused by improper installation or use of any of its products. ZLINE is under no obligation, by law or otherwise, to provide concessions, including repairs, prorates, rebates, discounts, or replacements, once the warranty has expired.

WARRANTY

SERIAL NUMBER LOCATION

Please write down the model number (highlighted in the image below as the “SKU”) and serial number of your appliance. Both numbers are located on the data plate located on the left side of your range top. Do not remove permanently affixed labels, warnings, or plates from the product. This will void the warranty. You may also consider attaching your receipt or proof of purchase to this manual.

ZLINE

ATTAINABLE LUXURY®

Product: Range top SKU: SRT36 Model No.: SRT36 Brand: ZLINE Kitchen and Bath Date: Month, Year Serial Number: SERIAL NUMBER		 Intertek 4002621	<p>Conforms to: ANSI STD Z21.1-2018 Certified to: CSA STD 1.1-2018 Household Cooking Gas Appliances.</p> <p>Do not store or use a gasoline liquid propane cylinder or other flammable vapors and liquids in the vicinity if this appliance.</p> <p>The gas appliance pressure regulator must be set for the gas with which the appliance is used.</p> <p>This appliance can be used with Propane gas and Natural gas. It is shipped from the factory adjusted for use with Natural gas. Conversion orifices are located on top of the grates. Follow the instructions packaged with the orifices for gas conversion.</p> <p>Conversion Kit: SDP-LPOK36</p> <p>May be vented. If vented, see installation instructions.</p> <p>ZLINE Kitchen and Bath 350 Parr Circle Reno, NV 89512</p>																																										
<table border="1" style="width: 100%; border-collapse: collapse;"> <thead> <tr> <th colspan="2">Type of Gas</th> <th>Burner</th> <th>NG</th> <th>LPG</th> <th>INPUT (BTU/Hr)</th> </tr> </thead> <tbody> <tr> <td>Natural Gas</td> <td>LP Gas</td> <td>A</td> <td>1.36 (2) + 0.73</td> <td>0.89 (2) + 0.53</td> <td>20000</td> </tr> <tr> <td></td> <td></td> <td>B</td> <td>1.57</td> <td>1.00</td> <td>12000</td> </tr> <tr> <td></td> <td></td> <td>C</td> <td>1.07</td> <td>0.74</td> <td>6000</td> </tr> <tr> <td></td> <td></td> <td>D</td> <td>1.36</td> <td>0.90</td> <td>9000</td> </tr> <tr> <td></td> <td></td> <td>E</td> <td>1.79</td> <td>1.16</td> <td>15000</td> </tr> <tr> <td></td> <td></td> <td>F</td> <td>1.36</td> <td>0.90</td> <td>9000</td> </tr> </tbody> </table>				Type of Gas		Burner	NG	LPG	INPUT (BTU/Hr)	Natural Gas	LP Gas	A	1.36 (2) + 0.73	0.89 (2) + 0.53	20000			B	1.57	1.00	12000			C	1.07	0.74	6000			D	1.36	0.90	9000			E	1.79	1.16	15000			F	1.36	0.90	9000
Type of Gas		Burner	NG	LPG	INPUT (BTU/Hr)																																								
Natural Gas	LP Gas	A	1.36 (2) + 0.73	0.89 (2) + 0.53	20000																																								
		B	1.57	1.00	12000																																								
		C	1.07	0.74	6000																																								
		D	1.36	0.90	9000																																								
		E	1.79	1.16	15000																																								
		F	1.36	0.90	9000																																								
<table border="1" style="width: 100%; border-collapse: collapse;"> <tr> <td style="text-align: center;">Max Power</td> <td style="text-align: center;">110-120VAC, 60HZ, 1W</td> </tr> </table>		Max Power	110-120VAC, 60HZ, 1W																																										
Max Power	110-120VAC, 60HZ, 1W																																												
<table border="1" style="width: 100%; border-collapse: collapse;"> <thead> <tr> <th></th> <th>Input Pressure</th> <th>Output Pressure</th> </tr> </thead> <tbody> <tr> <td style="text-align: center;">NG</td> <td style="text-align: center;">7 inch</td> <td style="text-align: center;">5 inch</td> </tr> <tr> <td style="text-align: center;">LPG</td> <td style="text-align: center;">11 inch</td> <td style="text-align: center;">10 inch</td> </tr> </tbody> </table>					Input Pressure	Output Pressure	NG	7 inch	5 inch	LPG	11 inch	10 inch																																	
	Input Pressure	Output Pressure																																											
NG	7 inch	5 inch																																											
LPG	11 inch	10 inch																																											

WARRANTY



SERVICE

For warranty service, please contact our Customer Service team at 1-614-777-5004 or visit www.zlinekitchen.com/contact to utilize our online Customer Experience Portal.



Scan the QR code to view the most up-to-date version of our Installation Manual and User Manual.



Need to purchase a part or accessory for your ZLINE product?
Visit www.zlineparts.com, ZLINE's official parts distribution partner.

2.2.4

zlinekitchen.com

1-614-777-5004

contact@zlinekitchen.com

ZLINE
ATTAINABLE LUXURY®