

ZIDI240BII

GE Monogram® Double-Drawer Refrigerator Module (Custom panel required)

ZIDS240BSS

GE Monogram Double-Drawer Refrigerator Module (Stainless steel)

Dimensions and Installation Information (in inches)

Installation Space

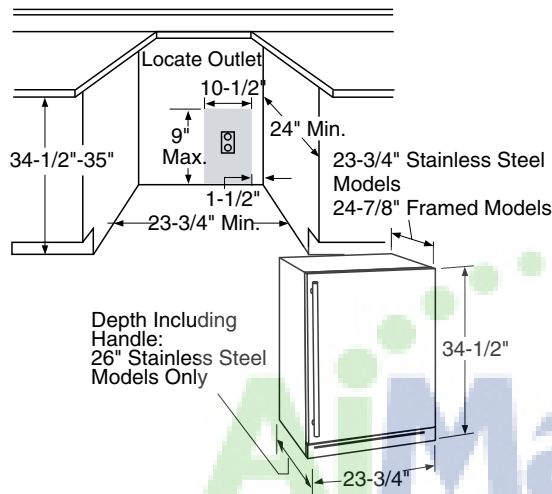

For a complete food storage center, install two Monogram refrigeration modules side-by-side.

Note: Reversible door swing on wine chillers/reserves and beverage centers only. See below for combination cutout dimensions.

Important Note: Products must operate from separate, properly grounded receptacles.

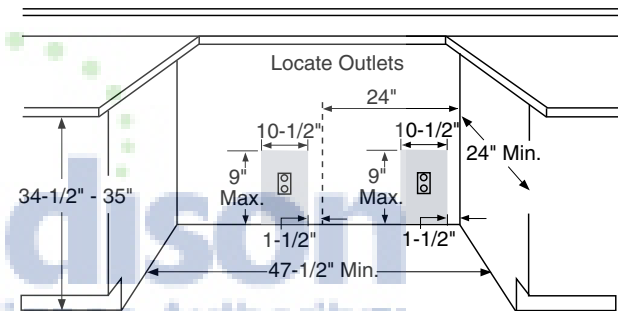

The cutout depth must be 24"

- Both models can be installed flush with standard cabinetry.
- Designed to be built-in only. Cannot be used free-standing.
- White case and drawer sides, black vented toe-kick with optional stainless steel toe-kick supplied.

Additional Specifications:

- A 120 volt 60Hz., 15 or 20 amp power supply is required. An individual property grounded branch circuit or circuit breaker is recommended. Install a properly grounded 3-prong electrical receptacle recessed into the back wall as shown. Electrical must be located on rear wall as shown.

Note: GFI (ground fault interrupter) is not recommended.

Note: Additional cutout width may be required for models with custom panels.

For answers to your Monogram®, GE Profile™ or GE® appliance questions, visit our website at ge.com or call GE Answer Center® service, 800.626.2000.



imagination at work



Listed by
Underwriters
Laboratories

ZIDI240BII

GE Monogram® Double-Drawer Refrigerator Module (Custom panel required)

ZIDS240BSS

GE Monogram Double-Drawer Refrigerator Module (Stainless steel)

Dimensions and Installation Information (in inches)

Grounding the Double-Drawer Refrigerator

IMPORTANT - (Please read carefully)

FOR PERSONAL SAFETY, THIS APPLIANCE MUST BE PROPERLY GROUNDED.

The power cord of this appliance is equipped with a 3-prong (grounding) plug which mates with a standard 3-prong (grounding) wall receptacle to minimize the possibility of electric shock hazard from this appliance.

Have the wall outlet and circuit checked by a qualified electrician to make sure the outlet is properly grounded.

When a standard 2-prong wall outlet is encountered, it is your personal responsibility and obligation to have it replaced with a properly grounded 3-prong wall outlet.

DO NOT, UNDER ANY CIRCUMSTANCES, CUT OR REMOVE THE THIRD (GROUND) PRONG FROM THE POWER CORD.

DO NOT USE AN ADAPTER PLUG TO CONNECT THE REFRIGERATOR TO A 2-PRONG OUTLET.

DO NOT USE AN EXTENSION CORD WITH THIS APPLIANCE.

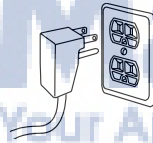

3/4" Overlay Panel Dimensions

Model ZIDI240WII requires customer-provided overlay drawer panel.

- The overlay panel must be secured to a 1/4" thick backer panel which slides into the trim. A .10" thick spacer panel must be placed between the custom and backer panel.

- A custom handle of your choice, supplied by your cabinet maker, must be installed on the overlay panel.

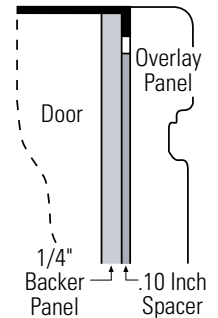

DO NOT, UNDER ANY CIRCUMSTANCES, CUT OR REMOVE THE THIRD (GROUND) PRONG FROM THE POWER CORD.

DO NOT USE AN ADAPTER PLUG TO CONNECT THE REFRIGERATOR TO A 2-PRONG OUTLET.

DO NOT USE AN EXTENSION CORD WITH THIS APPLIANCE.

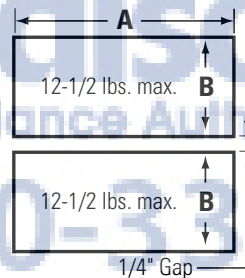

3/4" Overlay Panel Dimensions (in inches)

	A (Width)	B (Height)
1/4" Backer	23-3/16"	14-11/16"
0.10" Spacer	22-1/2"	14-3/16"
3/4" Overlay	23-5/8"	15-1/16"

NOTE: Max. assembled drawer panel weight is 25 lbs.

IMPORTANT: Maintain a 1/4" gap between the panels when installed.

Assemble overlay panels with glue and screws.

- Center spacer panel on the backer panel, left to right and top to bottom. Secure the panels with glue.
- Center the spacer/backer panel on the overlay panel. Secure with glue and screws. Countersink screws into the backer panel.

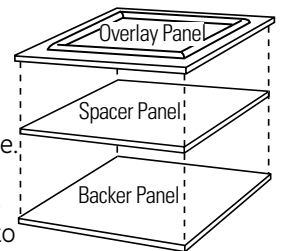

For answers to your Monogram®, GE Profile™ or GE® appliance questions, visit our website at ge.com or call GE Answer Center® service, 800.626.2000.



imagination at work

Specification Revised 7/05
120032



Listed by
Underwriters
Laboratories

Specification Created 1/11

120033

ZIDI240BII

GE Monogram® Double-Drawer Refrigerator Module (Custom panel required)

ZIDS240BSS

GE Monogram Double-Drawer Refrigerator Module (Stainless steel)

Features and Benefits

- Full-Extension Slide-Out Refrigerated Drawers - Storage for everything from whole melons to 146 12 oz. cans
- Electronic Adjustable Temperature Control - Offers a range of temperatures for precise chilling
- LED Temperature Display - Allows you to monitor the temperature at a glance
- Full-Width LED Lighting - Puts contents into clear view
- Custom Panel and Handle Required - Customer must install a custom door panel and handle to complement their décor (ZIDI240BII only)
- Adjustable Dividers - Maximizes usable storage space and flexibility
- Removable Drawer Bin - Convenient for separating loose items
- Fold-Down Shelf - Maximizes usable storage space
- Model ZIDS240BSS - Stainless steel
- Model ZIDI240BII - Custom panels and handles required

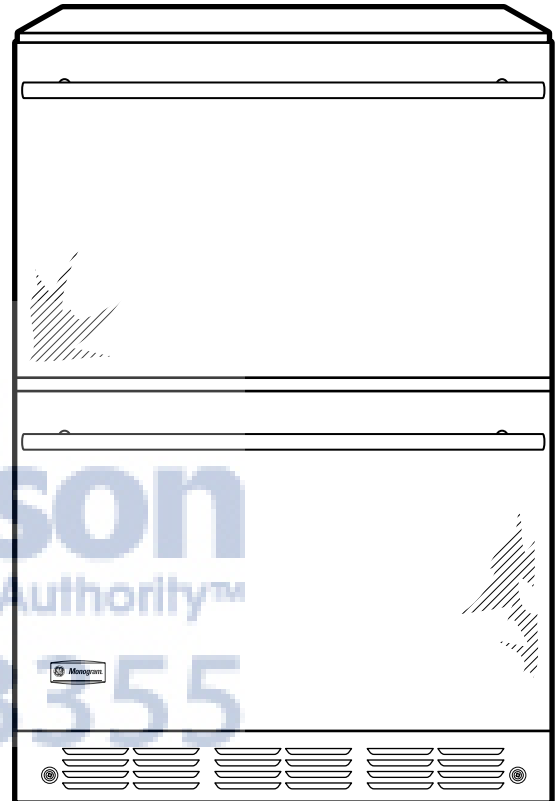

For answers to your Monogram,® GE Profile™ or GE® appliance questions, visit our website at ge.com or call GE Answer Center® service, 800.626.2000.



imagination at work



Listed by
Underwriters
Laboratories