



**QUICK FEATURES**

- Ready to accept custom or stainless steel panel
- Industry exclusive 4 independently-controlled temperature zone model for precision preservation of fresh foods
- Dual chamber air filtration throughout
- Touch-screen control streamlines the user experience. Enjoy access to smart settings for a variety of fresh foods, or customize to your preference in 1° increments. Access settings for lighting, Sabbath mode and more with a single touch.
- Brightly illuminated by white roll-on theatre lighting
- Frameless spill-proof shelving
- Tiered deli drawer provides storage for a variety of foods
- Tip-out produce bin provides ample storage for fresh produce
- Slide-in stainless steel pans provide space for marinating, storing pre-made appetizers or storing sous vide packets

**PRODUCT SPECIFICATIONS**

<b>Appliance Dimensions</b>	Exterior Width	29-3/4"
	Exterior Depth	24"*
	Exterior Height	83-11/16"
<b>Required Cutout Dimensions</b>	Cutout Width	30"
	Cutout Depth	25"
	Cutout Height	84"
<b>Depth with Door Open</b>	55-3/4" (less door overlay installed)	
<b>Product Weight</b>	560 lbs	
<b>Capacity</b>	16.6 cu. ft.	
<b>Electrical Requirements</b>	Electrical Supply	115V, 60 Hz., 1 Phase, 2.3 amps
	Electrical Service	15 amp dedicated circuit
	Power Cord/ Receptacle	NEMA 5-15 plug, 5' /3 prong grounding-type

\*Less panel. With typical 3/4" overlay panel installed, depth becomes 24-3/4"

**TEMPERATURE RANGES**

<b>Main Compartment</b>	Factory Set to 38° (Range 34°-42°F)
<b>Deli Drawer</b>	Factory Set to 33° (Range 32°-37°F)
<b>Meat/Fish Drawer</b>	Fish Factory Set to 33° (Range 32°-37°F) Meat Factory Set to 35° (Range 32°-37°F)
<b>Tip-Out Produce Bin</b>	Factory Set to 35° (Range 32°-37°F)

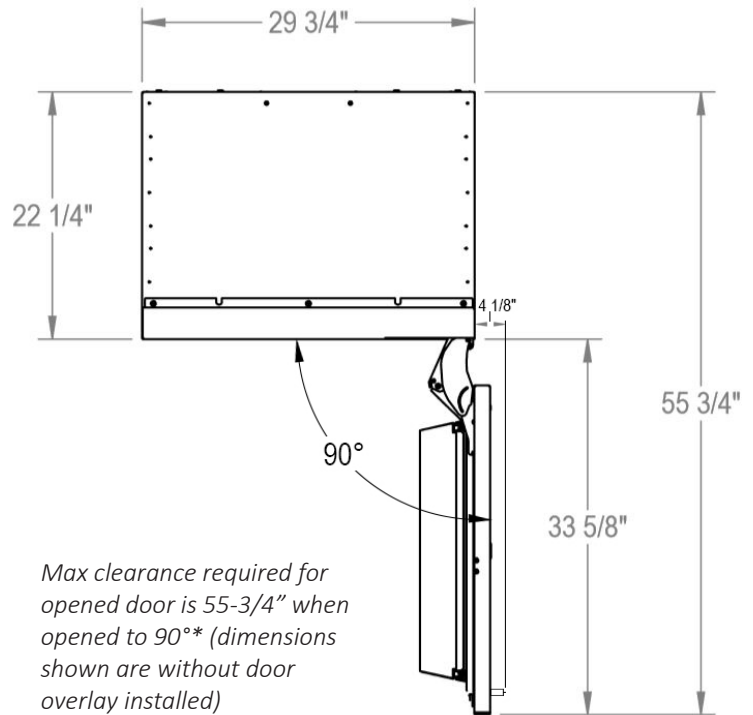

Max clearance required for opened door is 55-3/4" when opened to 90°\* (dimensions shown are without door overlay installed)

(please note that door opens to 115° without hinge pin installed)

**PLEASE NOTE:** When installing column adjacent to wall, a 2" clearance is required if door opens towards the wall \*90° achieved when included hinge stop pin is installed. Pin must be installed prior to full integration

**AVAILABLE MODELS**

CR30R-1-2L	Refrigerator, solid overlay ready, hinged left
CR30R-1-2R	Refrigerator, solid overlay ready, hinged right

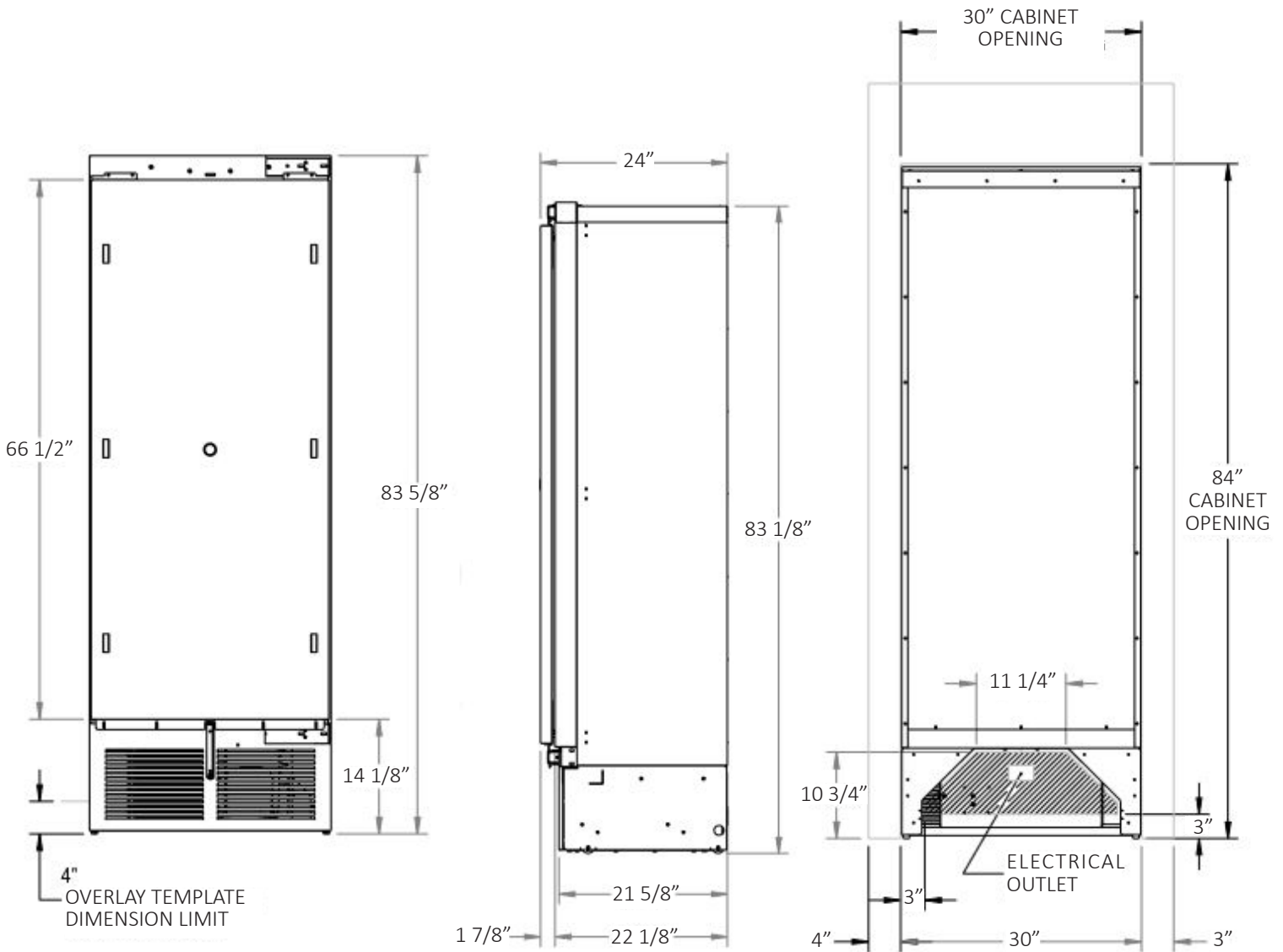

**ACCESSORIES**

- Dual installation kits
- Stainless steel exterior side finishing panels
- Stainless steel door panels with Perlick Pro Handle

Perlick accessories are available for purchase through an authorized Perlick dealer. For a full list of accessories and to find a dealer near you, visit [perlick.com/residential](http://perlick.com/residential).