



Refrigeration





Contents

- 2 Side-by-Side Refrigerator Advantages
- 4 Counter Depth Side-by-Side Refrigerators
- 6 Contoured Side-by-Side Refrigerators
- 8 Classic Side-by-Side Refrigerators
- 11 Top-Freezer Refrigerators
- 17 Bottom-Freezer Refrigerators & 50-lb Ice Makers
- 20 Water Filters
- 21 Accessories
- 22 Glossary
- 23 Specifications

Whirlpool® Side-by-Side Refrigerator Advantages



Model GF6NFEXRY in monochromatic stainless steel available Q4 2006

Whirlpool® side-by-side refrigerators are equipped with a host of innovative time-saving features, modern designs, and efficient operation. Choose the perfect fit for your style, get more storage space in both the freezer and refrigerator, and experience a one-of-a-kind ice and water dispensing system.

Whatever your choice, Whirlpool brand side-by-side feature packages give you more for your dollar investment and provide years of reliable operation.



Most Whirlpool brand side-by-side refrigerators are ENERGY STAR® qualified to use less energy and save you money.

No one has
Fewer Repairs
Rated by a leading consumer magazine January 2006

The quality and reliability of Whirlpool® side-by-side refrigerators is unrivaled. No one has had fewer repairs, as rated by a leading consumer magazine, for the past 9 years!



Styling

Choose Your
Styling Preference



Counter Depth

The flush design offers built-in style with added space to maneuver in the kitchen. A spacious interior and a full set of innovative features completes the package.



Contoured

The fitted curves of a formed door or the sleek, rounded edges of a smooth door project an elegant style.

Available
Q4 2006



Classic

Flat doors, plenty of storage space and popular features prove that traditional doesn't mean out of style.



Storage Space

We Moved the Ice Bin to the Door So You Can Store up to 8 More Frozen Pizzas*



In-Door-Ice® Ice Dispensing System

The ice bucket sits in the door, holding plenty of filtered ice out of the way. A push of a button removes it to easily fill coolers or multiple glasses.



More Freezer Capacity

With the ice in the door, freezer space is wide open to store up to 8 additional frozen pizzas.*

*Space advantage in Whirlpool® 25/26 cu. ft. models compared to same-size Whirlpool® models with conventional ice makers.



Convenience

Fill Any Size Container Twice as Fast with the Fast Fill Dispensing System**



2X Flow Rate

Water dispenses twice as fast as our previous dispensers, providing you with the convenience of chilled, filtered water in half the time.



Measured Fill

Select the exact amount of filtered water — in ounces, cups or liters — and the dispenser automatically shuts off when complete. Perfect for pasta or baking recipes.



Rotating Faucet

The faucet rotates 180°, allowing you to easily fill everything from a standard water glass to a large stock pot.



Slide-Out Dispenser Tray

Go hands-free with a dispensing tray that extends 1–3 inches, depending on the model.

**Compared to our previous dispensers. Patent pending.

Counter Depth Side-by-Side Refrigerators



Counter Depth Advantages:

Increased Exterior Space:



Flush Fit Design

- Fits flush with kitchen cabinets for a streamlined, built-in look
- Gives you back up to 6 inches in the kitchen

Two Sizes to Choose From

- 72" high counter depth models combine a flush look with a full 25 cu. ft. of capacity
- An industry exclusive *true* 69" tall model slides into an existing side-by-side cutout — top hinges and all

Abundant Interior Storage Space:



Drop Down Electronic Controls

- Controls recess into the top of the refrigerator compartment when not in use, providing added storage clearance on the top shelf for taller items

Flexible Storage Components

- Gallon door bins adjust up and down
- Glass shelves slide in and out
- Deep crispers keep fruits and vegetables fresh

Whirlpool® Side-by-Side Refrigerator Advantages:



Choice of
Styling



Storage
Space



Convenience

See pages 2 & 3 for more information.



	WHIRLPOOL GOLD®		WHIRLPOOL®
MODEL	GC5THEXN*	GC5NHAXS	EC3JHAXR
Capacity	25 cu. ft. (72" tall)	25 cu. ft. (72" tall)	23 cu. ft. (69" tall)
Handle type	Full-length Integrated	Full-length Exterior	Mid-length Exterior Stainless Steel Handle
Estimated availability	Available Now	June 2006	April 2006
WHIRLPOOL® ADVANTAGES			
Styling	Counter Depth Flat	Counter Depth Flat	Counter Depth Flat
In-Door-Ice® ice dispensing system	●	●	●
Fast Fill dispensing system	-	●	-
Rotating faucet	-	●	-
Measured fill	-	●	-
2X flow rate	-	●	-
Slide-out dispenser tray	-	●	-
ICE & WATER FEATURES			
Standard ice & water dispenser (non Fast Fill)	●	-	●
6-month water filtration	PUR®	PUR®	PUR®
Factory-installed ice maker	●	●	●
Water filter indicator light	●	●	●
Dispenser lockout	●	●	●
LED dispenser night-light	Auto	Auto	Auto
PERFORMANCE FEATURES			
ENERGY STAR® qualified		-	
Control system	Drop Down Electronic	Drop Down Electronic	Drop Down Electronic
In-Door-Air® door cooling system	●	●	-
Accu-Chill™ temperature management system	●	●	●
Sylvania Daylight™ interior lighting	●	●	●
Defrost system	Pulse	Pulse	Pulse
STORAGE FEATURES			
Refrigerator Compartment			
Door bins	2 Clear Adj. Gallon Bins, 1 EZ-Tote® Bin, 1 Fixed 2-Liter Bin, 1 Small Shelf	2 Clear Adj. Gallon Bins, 1 EZ-Tote® Bin, 1 Fixed 2-Liter Bin, 1 Small Shelf	3 Clear Adj. Gallon Bins, 1 Fixed 2-Liter Bin, 1 Small Shelf
No-slip, blue door bin mats	3	2	-
Adj. interior shelves	Slide-Out SpillGuard™ Glass	Slide-Out SpillGuard™ Glass	Slide-Out SpillGuard™ Glass
Crisper	1 Clear, Humidity-controlled	1 Clear, Humidity-controlled	1 Clear, Humidity-controlled
Meat pan	1 Clear (Convertible to Crisper)	1 Clear (Convertible to Crisper)	1 Clear (Convertible to Crisper)
Snack pan	1 Clear	1 Clear	1 Clear
Freezer Compartment			
Door bins	3 (2 Tilt-out)	3 (1 Tilt-out)	3
Adj. interior shelves	4	4	4
Baskets/Bins	3 Full Extension Baskets	3 Full Extension Baskets	3 Standard Extension Baskets
ADDITIONAL FEATURES			
Adjustable rubber rollers/sleeves	●	●	●
Factory-installed trim kit	●	-	-
COLORS			

Available Colors & Finishes:

Monochromatic Styling

Color-coordinated door, handle and dispenser housing

- White
- Biscuit
- Black
- Stainless Steel

Satina™
Stainless Look Finish

Black Accent Styling

Includes black handles and dispenser housing

- Satina™
Stainless Look Finish
- Stainless Steel

Satina™
Stainless Look Finish

- Accepts magnets
- Easy to clean without special cleaners
- Fingerprint resistant

For more detailed specifications and product images, visit www.whirlpool.com

See page 22 for descriptions of features.

*Model shown with stainless steel accessory panel.

See Counter Depth specifications on page 23 for accessory panel options.

No one has
Fewer Repairs
Rated by a leading consumer magazine January 2006

Contoured Side-by-Side Refrigerators



Whirlpool® Side-by-Side Refrigerator Advantages:



Choice of Styling



Storage Space



Convenience

See pages 2 & 3 for more information.



Side-by-Side Performance Features:



Water Filtration System

- Delivers 6 months of fresh ice and water
- Simple push-button design is easy to replace
- PUR® and UltraEase™ filtration systems available



In-Door-Air® Door Cooling System

- Upper door vents direct chilled air downward, creating a cool zone for milk and other items
- Adjustable air flow allows you to find the perfect door temperature for drinks or condiments



Automatic Defrost Systems

- Automatic — Preset to defrost daily
- Adaptive Defrost — Electronically measures freezer usage and can extend defrosting up to 96 hours, saving energy
- Pulse Defrost System — Cycles the defrost heater on and off for even greater energy savings and better preservation of frozen foods



		WHIRLPOOL GOLD®		WHIRLPOOL®
MODEL	GF6NFXR	GS6NBEXR	ES2FHAXS ES5FHAXS	
Capacity	26 cu. ft.	26 cu. ft.	22 cu. ft. 25 cu. ft.	
Handle type	Full-length Exterior	Full-length Exterior	Full-length Exterior	
Estimated availability	Now (Q,B); Q4 2006 (Y)	Now (Q,B,T,S,L); April 2006 (A,Y)	February 2006	
WHIRLPOOL® ADVANTAGES				
Styling	Formed Contoured Door	Smooth Contoured Door	Smooth Contoured Door	
In-Door-Ice® ice dispensing system	●	●	●	
Fast Fill dispensing system	●	●	-	
Rotating faucet	●	●	-	
Measured fill	●	●	-	
2X flow rate	●	●	-	
Slide-out dispenser tray	●	●	-	
ICE & WATER FEATURES				
Standard ice & water dispenser (non Fast Fill)	-	-	●	
6-month water filtration	PUR®	PUR®	PUR®	
Factory-installed ice maker	●	●	●	
Water filter indicator light	●	●	●	
Dispenser lockout	●	●	●	
LED dispenser night-light	Auto	Auto	●	
PERFORMANCE FEATURES				
ENERGY STAR® qualified				
Control system	SideWise™ Electronic	SideWise™ Electronic	Backlit Slide	
In-Door-Air® door cooling system	●	●	-	
Accu-Chill™ temperature management system	●	●	●	
Sylvania Daylight™ interior lighting	●	●	●	
Defrost system	Pulse	Pulse	Adaptive	
STORAGE FEATURES				
Refrigerator Compartment				
Door bins	2 Clear Adj. Gallon Bins, 2 EZ-Tote® Bins, 1 Fixed 2-Liter Bin	2 Clear Adj. Gallon Bins, 2 EZ-Tote® Bins, 1 Fixed 2-Liter Bin	3 Clear Adj. Gallon Bins, 1 Fixed 2-Liter Bin	
No-slip, blue door bin mats	2	2	-	
Adj. interior shelves	Slide-Out SpillGuard™ Glass	Slide-Out SpillGuard™ Glass	SpillGuard™ Glass	
Crisper	1 Clear, Humidity-controlled	1 Clear, Humidity-controlled	1 Clear, Humidity-controlled	
Meat pan	1 Clear (Convertible to Crisper)	1 Clear (Convertible to Crisper)	1 Clear (Convertible to Crisper)	
Snack pan	1 Clear	1 Clear	1 Clear	
Freezer Compartment				
Door bins	3 (2 Tilt-out)	3 (2 Tilt-out)	3 Trivets	
Adj. interior shelves	3	3	3	
Baskets/Bins	2 Baskets	2 Baskets	1 Bin	
ADDITIONAL FEATURES				
Adjustable rubber rollers/sleeves	●	●	●	
COLORS				

Available Colors & Finishes:

Monochromatic Styling

Color-coordinated door, handle and dispenser housing

- White
- Biscuit
- Black
- Stainless Steel

Satina™
Stainless Look Finish

Black Accent Styling

Includes black handles and dispenser housing

- Satina™
Stainless Look Finish
- Stainless Steel

Satina™
Stainless Look Finish

- Accepts magnets
- Easy to clean without special cleaners
- Fingerprint resistant

For more detailed specifications and product images, visit www.whirlpool.com

See page 22 for descriptions of features.

No one has
Fewer Repairs
Rated by a leading consumer magazine January 2006

Classic Side-by-Side Refrigerators



Side-by-Side Storage Features:



Gallon Door Storage with EZ-Tote® Handles

- Clear, adjustable and large enough to fit gallon containers
- Open up more storage space on the interior shelves
- EZ-Tote® handles make it easy to carry all your condiments to the table at once



Clear, Humidity-controlled Crisper

- Extra deep to store more; clear to find items at a glance
- Built-in slide control allows you to adjust the humidity level according to the items stored: set a higher level for leafy vegetables and a lower level to keep fruits crisp and fresh



Slide-out SpillGuard™ Glass Shelves

- Raised edges contain spills from falling to shelves below
- Slide-out for easy access and cleaning
- Adjustable up or down

Whirlpool® Side-by-Side Refrigerator Advantages:



Choice of Styling



Storage Space



Convenience

See pages 2 & 3 for more information.



WHIRLPOOL GOLD®

WHIRLPOOL®

MODEL	GD5NHAXS	ED2FHAXS ED5FHAXS	ED5FVGXS	ED2FHEXS ED5FHEXS	ED2FHGX ED5FHGX	ED2GHEXN ED5GHEXN	ED5GTGXN	ED2GTKXN
Capacity	25 cu. ft.	22 cu. ft. 25 cu. ft.	25 cu. ft.	22 cu. ft. 25 cu. ft.	22 cu. ft. 25 cu. ft.	22 cu. ft. 25 cu. ft.	25 cu. ft.	22 cu. ft.
Handle type	Full-length Exterior	Full-length Exterior	Mid-length Exterior	Full-length Exterior	Full-length Exterior	Full-length Exterior	Mid-length Exterior	Mid-length Exterior
Estimated availability	May 2006	March 2006	April 2006	March 2006	March 2006	Available Now	Available Now	Available Now
WHIRLPOOL® ADVANTAGES								
Styling	Classic Flat Door	Classic Flat Door	Classic Flat Door	Classic Flat Door	Classic Flat Door	Classic Flat Door	Classic Flat Door	Classic Flat Door
In-Door-Ice® ice dispensing system	●	●	-	-	-	-	-	-
Fast Fill dispensing system	●	-	-	-	-	-	-	-
Rotating faucet	●	-	-	-	-	-	-	-
Measured Fill	-	-	-	-	-	-	-	-
2X flow rate	●	-	-	-	-	-	-	-
Slide-out dispenser tray	●	-	-	-	-	-	-	-
ICE & WATER FEATURES								
Standard ice & water dispenser (non Fast Fill)	-	●	●	●	●	●	●	-
6-month water filtration	PUR®	PUR®	PUR®	PUR®	PUR®	UltraEase™	UltraEase™	-
Factory-installed ice maker	●	●	●	●	●	●	●	Optional
Water filter indicator light	●	●	-	●	-	●	-	-
Dispenser lockout	●	●	-	●	●	-	-	-
LED dispenser night-light	●	-	-	-	-	-	-	-
PERFORMANCE FEATURES								
ENERGY STAR® qualified			-				-	-
Control system	SideWise™ Electronic	Backlit Slide	Dial	Backlit Slide	Dial	Dial	Dial	Dial
In-Door-Air® door cooling system	●	-	-	-	-	-	-	-
Accu-Chill™ temperature management system	●	●	●	●	●	●	●	●
Sylvania Daylight™ interior lighting	●	●	-	●	●	-	-	-
Defrost system	Pulse	Adaptive	Auto	Adaptive	Adaptive	Adaptive	Auto	Auto
STORAGE FEATURES								
Refrigerator Compartment								
Door bins	3 Clear Adj. Gallon Bins, 1 Fixed 2-Liter	3 Clear Adj. Gallon Bins, 1 Fixed 2-Liter	3 White Adj. Gallon Bins, 1 Fixed 2-Liter	3 Clear Adj. Gallon Bins, 1 Fixed 2-Liter	3 White Adj. Gallon Bins, 1 Fixed 2-Liter	3 White Adj. Gallon Bins, 1 Fixed 2-Liter	3 White Adj. Gallon Bins, 1 Fixed 2-Liter	3 White Adj. Gallon Bins, 1 Fixed 2-Liter
Adj. interior shelves	Slide-Out SpillGuard™ Glass	SpillGuard™ Glass	SpillGuard™ Glass	SpillGuard™ Glass	SpillGuard™ Glass	SpillGuard™ Glass	Glass	Glass
Crisper	1 Clear, Humidity-controlled	1 Clear, Humidity-controlled	1 Clear, Humidity-controlled	1 Clear, Humidity-controlled	1 Clear, Humidity-controlled	1 Clear, Humidity-controlled	1 Clear	1 Clear
Meat pan	1 Clear (Convertible to Crisper)	1 Clear (Convertible to Crisper)	1 Clear	1 Clear (Convertible to Crisper)	1 Clear (Convertible to Crisper)	1 Clear (Convertible to Crisper)	1 Clear	1 Clear
Snack pan	1 Clear	1 Clear	-	1 Clear	-	-	-	-
Freezer Compartment								
Door shelves	3	3	5	5	5	5	5	5
Adj. interior shelves	4	4	4	4	4	4	4	5
Baskets/Bins	1 Basket	1 Bin	1 Bin	1 Bin	1 Bin	1 Bin	1 Bin	1 Bin
ADDITIONAL FEATURES								
Adjustable rubber rollers/sleeves	●	●	●	●	●	●	●	●
COLORS								
		<small>* (ED5FHAXS Only)</small>						

Available Colors & Finishes:

Monochromatic Styling

Color-coordinated door, handle and dispenser housing

- White
- Biscuit
- Black
- Stainless Steel
- Satina™ Stainless Look Finish

Black Accent Styling

Includes black handles and dispenser housing

- Satina™ Stainless Look Finish
 - Accepts magnets
 - Easy to clean without special cleaners
 - Fingerprint resistant
- Stainless Steel

For more detailed specifications & product images, visit www.whirlpool.com

See page 22 for descriptions of features.







Top-Freezer Refrigerators

Whirlpool top-freezer refrigerators include innovative features such as interior water dispensers and base grille filtration. Many models also offer adjustable door bins, giving you the flexibility to customize door storage the way you want it.

If you prefer the traditional style of the freezer on the top and the refrigerator on the bottom, Whirlpool brand has you covered, with a wide variety of sizes and colors from which to choose.



Look for ENERGY STAR® qualified Whirlpool brand top-freezer refrigerators that use less energy to save you money.

No one has
Fewer Repairs
Rated by a leading consumer magazine January 2006

The quality and reliability of Whirlpool brand top-freezer refrigerators is also top-quality: No other brand has fewer repairs for each of the last 4 years.

Top-Freezer Refrigerators



Door Styles

Top-freezer refrigerators offer two door handle styles. Bow handles let you access your favorite foods at any height. Integrated handles add a touch of style to refrigerator fronts.



Reach-Through Bow Handle Style



Integrated Cup Handle Style



Top-Freezer Performance Features:



Water Filtration Systems

- Choose from exterior or interior dispensing systems
- Delivers 6 months of fresh water
- Base grille filter location is easy to reach and change
- Filter light illuminates when a replacement filter is needed



SpaceSmart™ Cooling System

- Tri-level recessed vents channel cold air evenly throughout the refrigerator to keep foods cold
- The space-saving design offers performance without sacrificing storage space inside the refrigerator



Accu-Chill™ Temperature Management System

- Double tub construction isolates refrigerator and freezer compartment temperatures
- Foam-in-Place door construction provides excellent insulation and more precise temperature control
- With fewer cracks and crevices, the interiors are easy to clean



WHIRLPOOL GOLD®				WHIRLPOOL®			
MODEL	GR2SHWXP	GT1SHTXM	GR9FHMXP GR2FHMXP	ET9FHTXM ET1FHTXM	ER2MHKXP	ET8MHKXM ET1MHKXM	ET8FTEXR
Capacity	22 cu. ft.	21 cu. ft.	19 cu. ft. 22 cu. ft.	19 cu. ft. 21 cu. ft.	22 cu. ft.	18 cu. ft. 21 cu. ft.	18 cu. ft.
Door style	Contoured, Smooth	Flat, Textured	Contoured, Smooth	Flat, Textured	Contoured, Smooth	Flat, Textured	Flat, Textured
Handle type	Integrated Cup	Reach-Through Bow	Integrated Cup	Reach-Through Bow	Integrated Cup	Reach-Through Bow	Reach-Through Bow
ICE & WATER FEATURES							
Exterior water dispenser	●	-	-	-	-	-	-
Interior water dispenser	-	●	-	●	-	-	-
6-month water filtration	UltraEase™	UltraEase™	-	UltraEase™	-	-	-
Factory-installed ice maker	●	●	●	●	Optional	Optional	Optional
EZ-Change™ filter	●	●	-	●	-	-	-
EZ-Change™ indicator light	●	●	-	-	-	-	-
PERFORMANCE FEATURES							
ENERGY STAR® qualified					-	-	
Control system	Up-front	Up-front	Up-front	Up-front	Up-front	Up-front	Up-front
Accu-Chill™ temperature management system	●	●	●	●	●	●	●
Sylvania Daylight™ interior lighting	●	●	●	-	-	-	-
Defrost system	Auto	Auto	Auto	Auto	Auto	Auto	Auto
STORAGE FEATURES							
Refrigerator Compartment							
Door bins	3 EZ-Tote® Bins, 1 Fixed 2-Liter Full-width	3 Clear Adj. Gallon Bins, 1 Fixed 2-Liter Full-width	3 EZ-Tote® Bins, 1 Fixed 2-Liter Full-width	3 White Adj. Gallon Bins, 1 Fixed 2-Liter Full-width	3 White Adj. Gallon Bins, 1 Fixed 2-Liter Full-width	3 White Adj. Gallon Bins, 1 Fixed 2-Liter Full-width	3 White Adj. Gallon Bins, 1 Fixed 2-Liter Full-width
No-slip, blue door bin mats	3	-	1	-	-	-	-
Utility compartment	Clear Sliding	Clear Fixed	Clear Sliding	Clear Fixed	Clear Sliding	White Fixed	Clear Fixed
Adj. interior shelves	Slide-out SpillGuard™ Glass	Slide-out SpillGuard™ Glass	SpillGuard™ Glass	SpillGuard™ Glass	SpillMizer™ Glass	SpillMizer™ Glass	SpillMizer™ Glass
Crispers	2 Clear Humidity-controlled	2 Clear Humidity-controlled	2 Clear Humidity-controlled	2 Clear Humidity-controlled	2 Clear Humidity-controlled	2 Clear Humidity-controlled	2 Clear Humidity-controlled
Meat pan	1 Clear	1 Clear	1 Clear	1 Clear	1 Clear	1 Clear	1 Clear
Freezer Compartment							
Freezer floor	Slide-out	Fixed	Fixed	Fixed	Fixed	Fixed	Fixed
Interior shelf	Full-width Fixed	Full-width Fixed	Full-width Fixed	Full-width Fixed	Full-width Fixed	Full-width Fixed	Full-width Fixed
Door storage	2 Full-width Tilt-out Bins	2 Full-width Fixed Shelves	2 Full-width Fixed Shelves	2 Full-width Fixed Shelves	2 Full-width Fixed Shelves	2 Full-width Fixed Shelves	2 Full-width Fixed Shelves
ADDITIONAL FEATURES							
Adjustable levelers	●	●	●	●	●	●	●
COLORS							
			* (GR2FHMXP Only)	* (ET1FHTXM Only)			

Available Colors & Finishes:



Satina™
Stainless Look Finish

- Accepts magnets
- Easy to clean without special cleaners
- Fingerprint resistant

For more detailed specifications & product images, visit www.whirlpool.com
See page 22 for descriptions of features.



Top-Freezer Refrigerators



Adjustable Door Bins
Move Where and When
You Need Them



Top-Freezer Storage Features:



Adjustable Door Bins

- Clear, adjustable and large enough to fit gallon containers
- Open up more storage space on the interior shelves
- EZ-Tote® handles make it easy to carry all your condiments to the table at once



Pull-out Freezer Floor

- Freezer floor glides out smoothly
- Easily reach items stored in the back



Clear, Humidity-controlled Crisper

- Extra deep to store more; clear to find items at a glance
- Built-in slide control allows you to adjust the humidity level according to the items stored: set a higher level for leafy vegetables and a lower level to keep fruits crisp and fresh



WHIRLPOOL®

MODEL	ET8WTKXK ET8WTMXX	ET8WTEXM	ER6AHKXS ER8AHKXR	ET8AHKXR ET8AHMXXR	ET4WSKXS ET6WSKXS	ET5WSEXS	ET0WSRXM
Capacity	18 cu. ft.	18 cu. ft.	16 cu. ft. 18 cu. ft.	18 cu. ft.	14 cu. ft. 16 cu. ft.	15 cu. ft.	10 cu. ft.
Door style	Flat, Textured	Flat, Textured	Contoured, Smooth	Flat, Textured	Flat, Textured	Flat, Textured	Contoured, Smooth
Handle type	Reach-Through Bow	Reach-Through Bow	Integrated Cup	Reach-Through Bow	Reach-Through Bow	Reach-Through Bow	Integrated Cup
ICE & WATER FEATURES							
Factory-installed ice maker	ET8WTMXX (Optional - ET8WTKXK)	Optional	Optional	ET8AHMXXR (Optional - ET8AHKXR)	Optional	Optional	-
PERFORMANCE FEATURES							
ENERGY STAR® qualified	-		-	-	-		-
Control system	Up-front	Up-front	Up-front	Up-front	Up-front	Up-front	Rear
Accu-Chill™ temperature management system	•	•	•	•	•	•	•
SpaceSmart™ cooling system	-	-	•	-	-	-	-
Defrost system	Auto	Auto	Auto	Auto	Auto	Auto	Auto
STORAGE FEATURES							
Refrigerator Compartment							
Door bins	Fixed Gallon Shelves	Fixed Gallon Shelves	Fixed Gallon Shelves	Fixed Gallon Shelves	Fixed Shelves	Fixed Shelves	Fixed Shelves
Utility compartment	Clear Fixed	Clear Fixed	Clear Fixed	Clear Fixed	Fixed	Fixed	-
Adj. interior shelves	Wire	Wire	SpillMizer™ Glass	SpillMizer™ Glass	Wire	Wire	Wire
Crispers	2 Clear	2 Clear	2 Clear Humidity-controlled	2 Clear Humidity-controlled	1 Full-width White	1 Full-width White	1 Full-width Clear
Meat pan	1 Clear	1 Clear	1 Clear Sliding	1 Clear	-	-	-
Freezer Compartment							
Freezer floor	Fixed	Fixed	Fixed	Fixed	Fixed	Fixed	Fixed
Interior shelf	Full-width Fixed	Full-width Fixed	Full-width Fixed	Full-width Fixed	Partial Shelf	Partial Shelf	Full-width Fixed
Door storage	2 Full-width Fixed Shelves	2 Full-width Fixed Shelves	2 Full-width Fixed Shelves	2 Full-width Fixed Shelves	2 Full-width Fixed Shelves	2 Full-width Fixed Shelves	2 Full-width Fixed Shelves
ADDITIONAL FEATURES							
Adjustable levelers	•	•	•	•	•	•	•
COLORS							
			 *(ER8AHKXR Only)				

Available Colors & Finishes:

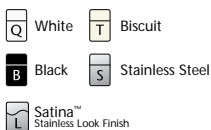

Satina™
Stainless Look Finish

- Accepts magnets
- Easy to clean without special cleaners
- Fingerprint resistant

For more detailed specifications & product images, visit www.whirlpool.com
See page 22 for descriptions of features.







Bottom-Freezer Refrigerators & 50-lb Ice Makers

As a statement in style or a combination of convenience, bottom-freezer refrigerators from Whirlpool brand stand out from the crowd. A wide-opening refrigerator on top offers eye-level browsing, while the full-width freezer basket (in door or drawer styles) delivers flexibility in cold storage. And with each model meeting ENERGY STAR® qualifications, you can rest easy knowing you're saving both money in utility bills and doing your part to conserve our natural resources.

Whirlpool brand high-performance ice makers produce up to 50 pounds of clear, cubed ice within 24 hours. Host a whole weekend of parties and never run out of ice.



All Whirlpool brand bottom-freezer refrigerators are ENERGY STAR® qualified to use less energy and save you money.

Bottom-Freezer Refrigerators



Bottom-Freezer Features:



Choice of Freezer Access

- Slide-out drawer models offer easy access to stored items in the rear
- Swing-out door models offer traditional storage solutions



Slide-out SpillGuard™ Glass Shelves

- Raised edges can contain up to 12 ounces of liquid and help prevent leaks from spilling to the shelves below
- Slide-out design makes clean-up easy



Adjustable Door Bins

- Clear bins and shelves hold gallon containers
- Move them up or down to customize storage space



WHIRLPOOL GOLD®

MODEL	GB2SHDXP	GB9SHDXP	GB9SHKXM
Capacity	22 cu. ft.	19 cu. ft.	19 cu. ft.
Freezer drawer	•	•	-
Side-swing freezer door	-	-	•
ICE & WATER FEATURES			
Factory-installed ice maker	•	Optional	Optional
PERFORMANCE FEATURES			
ENERGY STAR® qualified			
Control system	Up-front Electronic	Up-front Electronic	Up-front Dial
Accu-Chill™ temperature management system	•	•	•
Defrost system	Auto	Auto	Auto
STORAGE FEATURES			
Refrigerator Compartment			
Clear adjustable gallon door bins	•	•	•
Gallon door storage	•	•	•
Adj. glass shelves	Slide-out SpillGuard™	Slide-out SpillGuard™	Slide-out SpillGuard™
Utility compartment	•	•	•
Humidity-controlled crispers	•	•	•
Meat pan	•	•	•
Egg bin	•	•	•
Freezer Compartment			
Slide-out basket	•	•	-
Removable shelf	-	-	•
Freezer light	•	•	•
COLORS			

Available Colors & Finishes:

- White Biscuit
- Black Stainless Steel

For more detailed specifications & product images, visit www.whirlpool.com
See page 22 for descriptions of features.



Whirlpool Gold® Automatic Ice Makers

Produce up to 50 pounds of clear, cubed ice within 24 hours. Model G11500PH features an integrated drain pump for flexible installation in locations without a floor drain under the unit.



G11500PH - 50 lb.

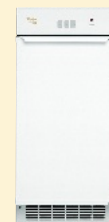

G11500XH - 50 lb.

Water Filters



Six Months of Water — Right in Your Hand

If you want the best performance from your car, change the oil every three months. If you want the best security online, change your password every four months. To get the best-tasting water and highest quality ice from your Whirlpool brand refrigerator, change the water filter every six months.

Your refrigerator's water dispenser provides an economical source of water. Over its 6-month life, the water filter processes as many as 200 gallons.* Save money and hassle by buying — and carrying — fewer bottles of water. Cold, filtered water is right at your fingertips with a Whirlpool brand refrigerator's water filtration system.

Fewer bottles of water in your refrigerator means more storage space. Items are easy to see and rearrange when you get your drinking water from your refrigerator's water dispenser. Most filtration systems even have an indicator light reminding you when a replacement filter is needed. Whirlpool brand water filters are conveniently located on the exterior in the base grille and are simple to replace.

If you are not sure about the correct replacement water filter for your refrigerator, please call 1-800-253-1301 (8 am–6 pm EST, Monday–Friday) or visit our web site at www.whirlpool.com.

*May vary with local water conditions and usage.

Replacement Water Filters



PUR® Water Filters

PUR® filters with push button replacement reduce lead, chlorine taste, and odor. They are NSF Certified and retain beneficial fluoride in the water. Using the correct filter in the Fast Fill refrigerator assures proper flow rate.
For Fast Fill dispensing refrigerators: 4396841
For side-by-side PUR® filter models: 4396710



UltraEase™ 1/4 Turn Water Filter

Reduces cysts, lead, chlorine taste, and odor. This filter is NSF Certified and retains beneficial fluoride. (4396510)

The contaminants reduced by these filters are not necessarily in all users' water.



Push Button Replacement

Water filter replacement becomes even easier with the push button system. There's no need to shut down the water supply. Simply press the button and the old water filter is released. Then insert a new water filter by clicking it into place.



Whirlpool brand water filters are NSF Certified

A single Whirlpool brand water filter processes up to 200 gallons of cold, filtered water.*

Accessories

Ice & Water Hook-up Kits

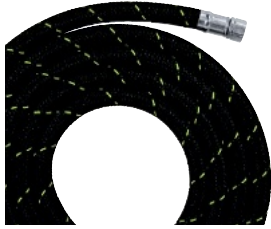

Industrial Grade Refrigerator Hose

Includes everything needed for easy installation: 7-ft braided tubing and fittings provides water to ice makers and ice & water dispensers. (8212490RC/8212490RP)

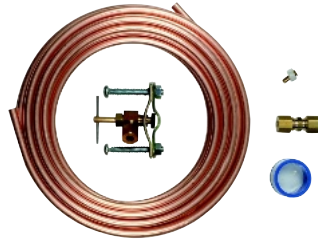

Copper Refrigerator Water Supply Kit

Use this kit to hook up your automatic ice maker or ice & water dispenser. Kit includes 15 feet of copper water supply line, a saddle valve with coupling union, Teflon® tape and all the necessary hardware. (8003RC/8003RP)



Refrigerator Water Supply Line

Use this 5-ft PEX tubing and fittings to provide water to your automatic ice maker or ice & water dispenser. (8212547RP)

Cleaning



Stainless Steel Cleaner

Maintain that brand-new stainless steel shine with this specially formulated cleaner. Whirlpool Corporation tested numerous cleaners and found the best to offer to you. Works on food spills, grime and stains. (31462)



All Purpose Appliance Cleaner

Give your kitchen that brand new shine with a hint of citrus scent. This all-purpose appliance cleaner cuts through grease and grime to clean most surfaces, from appliances to countertops. It can even be used inside the refrigerator or MHC. (31662)

Glossary

Accu-Chill™ Temperature Management System

Foam-in-Place doors and Double Tub construction provide accurate temperature control for storing food and beverages in both the refrigerator and freezer compartments.

Adaptive Defrost Control (ADC)

The Adaptive Defrost Control adjusts the frequency of defrost by monitoring the compressor run-time and the evaporator heater on-time. Depending on usage, ADC models can have fewer defrosts, resulting in improved food preservation and energy savings.

Adjustable Door Storage

Adjustable door bins move where and when you need them, giving you the flexibility to store beverages anywhere in the refrigerator door.

Automatic Ice Production

The Icemagic® system produces ice 50% faster than previous Whirlpool brand models, perfect during parties or any time extra ice is needed.

Clear Humidity-controlled Crispers

These crispers are extra deep so you can store more of your favorite fruits and vegetables. The ability to control the humidity levels helps you preserve their freshness. Choose a higher level for leafy vegetables and a lower level for fruits. The clear design keeps everything in sight.

Clear Temperature-controlled Meat Pan

Preserve the freshness of your meat in a temperature-controlled pan. Cool air from the freezer enters the meat pan at the level you select.

Contoured Door Styling

Refrigerators featuring contoured doors exhibit a stylishly sleek silhouette. Rounded edges and hidden hinges combine with a high-gloss finish to complement any kitchen decor.

Double Tub Construction

With double tub construction, a layer of foam is injected between the freezer and refrigerator compartments. The added insulation creates a stronger structure and decreases temperature swings.

Drop Down Electronic Controls

Electronic temperature controls drop down for easy access and viewing. The innovative design allows you to hide them away when not in use.

Electronic EZ-Touch™ Water Dispenser

Conveniently access chilled, filtered water on the outside of the refrigerator. A child-lockout feature prevents accidental operation. Some dispensers include an automatic LED night-light that adjusts brightness as the kitchen goes dark.

ENERGY STAR® Qualified

Refrigerators with this rating exceed minimum federal energy standards by at least 15%.

EZ-Change™ Filter and Indicator Light

The EZ-Change™ filter is included with each UltraEase™ filtration system. It removes odors and provides great-tasting water for up to 6 months. A quarter turn easily removes the filter when the indicator light says it is time for a replacement.

EZ-Tote® Door Bins

Built-in handles allow for the ultimate in portability. Move condiments or other items directly from the refrigerator door to the table. Multiple placement options for storing the bin keep door storage flexible.

Fast Fill Dispensing System

This new and revolutionary dispensing system utilizes a high-flow water valve that delivers chilled, filtered water without the wait. Combined with a dispenser area that's 50% larger in size, a slide-out tray and rotating faucet, the entire system fills any size container twice as fast as previous Whirlpool brand dispensers.

Flexi-Glide™ Pull-out Freezer Floor

Conveniently reach items in the back of the freezer with a floor that glides back and forth.

Foam-in-Place Doors

Foam is injected into the door cavity to provide an increased layer of insulation, keeping the cold air right where you want it.

Formed Door Styling

Select side-by-side refrigerators feature a uniquely-styled, European-inspired door with elegant curves and angles.

Hidden Controls

Electronic temperature controls are out of sight, thanks to the innovative design of hidden controls. When adjustments are needed, these controls drop down for easy access and viewing.

In-Door-Air® Door Cooling System

A special baffle channels cold air from the freezer into the refrigerator door, making it as cold as the rest of the refrigerator.

In-Door-Ice® Ice Dispensing System

This ice dispensing system is located in the door of the freezer. As a result, extra space on the top shelf gives you the freedom to store more of your favorite foods.

Measured Fill

An integral part of the Fast Fill dispenser, Measured Fill technology lets you select the exact amount of filtered water — in ounces, cups or liters — that you need. The dispenser will accurately fill the container and automatically shut off when complete.

No Slip Blue Door Bin Mats

Items stored in the door bins stay upright when resting on a no slip mat. Keep condiments and drinks neatly in place. The mats are also removable for easy cleaning.

Pulse Defrost System

The Pulse Defrost System includes Adaptive Defrost Control, plus a pulse defrost feature that cycles the evaporator heater on and off during the defrost cycle to minimize freezer temperature swing. More consistent freezer temperatures result in fewer ice crystals, less freezer burn and energy savings.

PUR® Water Filtration System

The PUR® water filtration system reduces additional impurities from household water, giving you chilled, filtered water direct from your refrigerator. The base grille filter is located out of the way, yet easy to reach for filter replacements.

Satina™ Stainless Look Finish

The low-maintenance Satina™ finish resists fingerprints for a smooth, glossy appearance. It gives your kitchen classic beauty with everyday practicality.

SideWise™ Electronic Controls

These controls are located in the upper left corner of the refrigerator to create more usable space on the top shelf.

SpaceSmart™ Cooling System

Tri-level, recessed vents channel cold air evenly throughout the refrigerator to keep foods cold without taking up storage space.

SpillGuard™ Glass Shelves

These glass shelves feature raised edges which can contain up to 12 ounces of liquid, preventing leaks from spilling onto shelves below. Some models feature slide-out shelves for even easier clean up.

SpillMizer™ Glass Shelves

Messy leaks are minimized with SpillMizer™ glass shelves. These adjustable, transparent shelves help contain spills for easier cleanup.

Sylvania Daylight™ Interior Lighting

This interior lighting system provides a whiter, more natural light that helps make every item easily visible and quick to locate.

UltraEase™ Water Filtration System

The UltraEase™ water filtration system reduces unwanted impurities and odor from your water for up to 6 months. Located in the base grille, the filter is easy to reach and replace.

Up-front Temperature Controls

These controls are located towards the front of the refrigerator, making temperature management easy.

Counter Depth Refrigerator Specifications

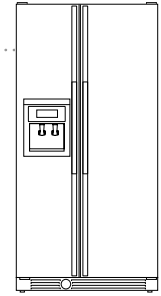

Counter Depth Model Dimensions & Capacity

(All dimensions in inches)

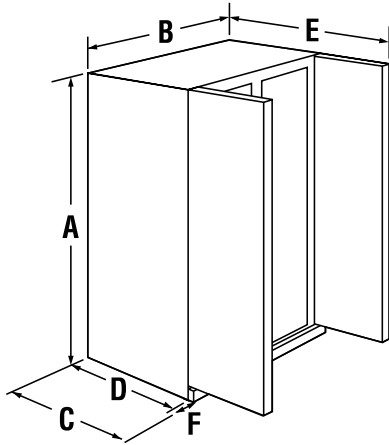

Model Number	Dimensions						Capacity		
	A	B	C	D	E	F	Total Volume (cu. ft.)	Freezer Volume (cu. ft.)	Total Shelf Area (sq. ft.)
GC5THEXN	71-1/2	35-5/8	29-7/8	24	45-3/8	1/2	24.5	9.6	24.7
GC5NHAXS	71-1/2	35-5/8	29-7/8	24	45-3/8	1/2	24.5	9.6	24.7
EC3JHAXR	68-1/2	35-5/8	30-1/8	24	45-1/2	1/2	23.1	9.1	25.1

NOTE: Add 1/2" to each side for recessed installation. Dimensions shown are for planning purposes only. For complete information, see installation instructions packed with product.

Custom Panel Dimensions

Whirlpool® Counter Depth Refrigerator GC5THEXN

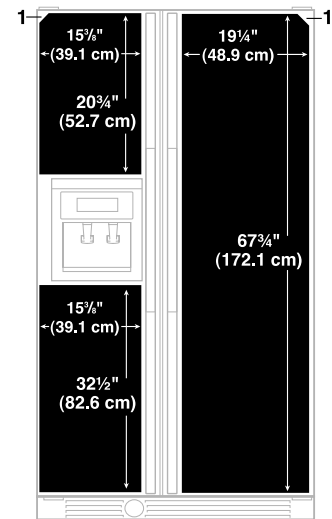

1. 1/8" x 1/8" (3.2 x 3.2 mm) chamfer

1. 1/8" x 1/8" (3.2 x 3.2 mm) chamfer

NOTE: Dimensions shown are for planning purposes only. For complete information, see installation instructions packed with product.

Whirlpool® Side-by-Side Refrigerator Accessory Panels

Model Number	White Panel	Biscuit Panel	Black Panel	Stainless-Look Panel (Brushed Aluminum)
GC5THEXN	4396758	4396760	4396759	4396761

Stainless Steel Side Panel Accessory Kits (1 panel per kit)

Model Number	Accessory Number
GC5THEXN	4396352
GC5NHAXS	4396352
EC3JHAXR	4396748



Perimeter Kits for Counter Depth Side-by-Sides

Model Number	Color	Accessory Number
GC5NHAXSQ	White	4396789
GC5NHAXST	Biscuit	4396790
GC5NHAXSB	Black	4396791
GC5NHAXSS	Stainless Steel	4396792

NOTE: Add 3" to each side for ease of installation and 3" at top for air circulation. When planning a recessed installation, add 3" of air space to each side and 2" in back.

Side-by-Side Refrigerator Specifications

Side-by-Side Model Dimensions & Capacity (All dimensions in inches)

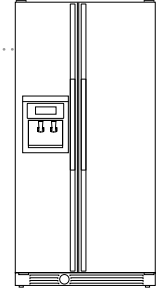
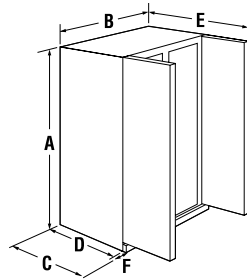

Model Number	Dimensions						Capacity		
	A	B	C	D	E	F	Total Volume (cu. ft.)	Freezer Volume (cu. ft.)	Total Shelf Area (sq. ft.)
GF6NFEXR	68-7/8	35-1/2	35-1/4	29-1/4	50		25.6	10.1	26.4
GS6NBEXR	68-7/8	35-1/2	35-1/4	29-1/4	50		25.6	10.1	26.4
GD5NHAXS	68-7/8	35-1/2	33-1/4	29-1/4	50	7/8	25.6	10.1	26.4
ES5FHAXS	68-7/8	35-1/2	35-3/4	29-1/4	49-7/8	11/16	25.4	10.0	24.2
ES2FHAXS	65-7/8	32-3/4	35-1/4	29-1/4	50	11/16	22.0	7.4	23.7
ED5FHAXS	68-7/8	35-1/2	33-3/4	29-1/4	49-7/8	11/16	25.4	10.0	24.2
ED2FHAXS	65-7/8	32-3/4	35-1/4	29-1/4	50	11/16	22.0	7.4	23.7
ED5FVGXS	68-7/8	35-1/2	33-3/4	29-1/4	49-7/8	11/16	25.4	10.0	24.2
ED5FHEXS	68-7/8	35-1/2	33-3/4	29-1/4	49-7/8	11/16	25.3	9.9	25.9
ED2FHEXS	65-7/8	32-3/4	33-3/4	29-1/4	49-7/8	11/16	21.8	7.4	22.0
ED5FHGX	68-7/8	35-1/2	33-3/4	29-1/4	49-7/8	11/16	25.3	9.9	24.4
ED2FHGX	65-7/8	32-3/4	33-3/4	29-1/4	49-7/8	11/16	21.8	7.4	20.5
ED5GHEXN	68-7/8	35-1/2	33-3/4	29-1/4	49-7/8	11/16	25.3	9.9	24.4
ED2GHEXN	65-7/8	32-3/4	33-3/4	29-1/4	49-7/8	11/16	21.8	7.4	20.5
ED5GTGXN	68-7/8	35-1/2	33-3/4	29-1/4	49-7/8	11/16	25.3	9.9	24.4
ED2GTKXN	65-7/8	32-3/4	33-3/4	29-1/4	49-7/8	11/16	21.7	7.2	22.8

NOTE: Add 1/2" to each side for recessed installation. Add 5" for corner application for GS models. Dimensions shown are for planning purposes only. For complete information, see installation instructions packed with product.

Electrical requirements:
115V, 60Hz. (Subject to local codes.) Listed by Underwriters' Laboratories, Inc.

Stainless Steel Side Panel Accessory Kits (1 panel per kit)

Model Number	Accessory Number
All 25 cu. ft. full-depth side-by-sides	4396351



Top-Freezer Refrigerator Specifications

Top & Bottom-Freezer Model
Dimensions & Capacity
(All dimensions in inches)

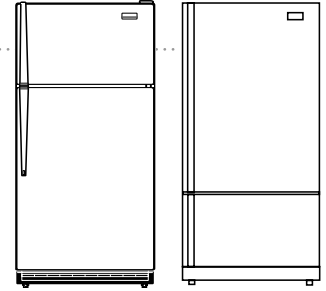
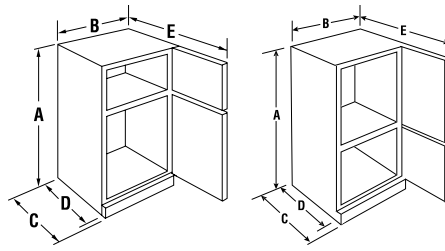

Model Number	Dimensions					Capacity			
	A	B	C	D	E	Total Volume (cu. ft.)	Refrigerator Volume (cu. ft.)	Freezer Volume (cu. ft.)	Total Shelf Area (sq. ft.)
GR2SHWXP	65-1/2	32-1/2	32-1/4	27-1/4	61-1/4	21.7	15.3	6.4	25.7
GT1SHTXM	65-1/2	32-1/2	31-3/8	28-1/4	61	21.0	14.5	6.5	25.1
GR2FHMXP	65-1/2	32-1/2	31-1/2	27-1/4	61-1/4	21.7	15.3	6.4	25.7
GR9FHMXP	65-1/2	29-1/2	31-1/2	27-1/4	58-1/4	18.9	13.9	5	22.8
ER2MHKXP	65-1/2	32-1/2	31-1/2	27-1/4	61-1/4	21.7	15.3	6.4	25.7
ET1FHTXM	65-1/2	32-1/2	31-3/8	28-1/4	61	20.9	14.4	6.5	25.1
ET9FHTXM	65-3/8	29-1/2	32-3/4	27-1/4	58	18.9	13.9	5	22.8
ET8FTEXR	65-3/8	29-1/2	31-3/8	27-1/4	58	18.2	13.2	5	21.9
ET1MHKXM	65-1/2	32-1/2	31-3/8	27-5/8	61	21	14.6	6.4	25.6
ET8MHKXM	65-3/8	29-1/2	31-3/8	27-1/4	58	18.3	13.3	5	22.3
ET8WTKXX	65-3/8	29-1/2	31-3/8	27-1/4	58	18.3	13.3	5	22.3
ET8WTMXK	65-3/8	29-1/2	31-3/8	27-1/4	58	18.3	13.3	5	22.3
ET8WTEXM	65-3/8	29-1/2	31-3/8	27-1/4	58	18.3	13.3	5	22.3
ER8AHKXR	68	28	31	27-5/8	56-1/4	17.6	13.5	4.1	18.1
ET8AHKXR	68	28	32-7/8	27-3/4	57	17.6	13.5	4.1	18.5
ET8AHM XR	68	28	32-7/8	27-3/4	57	17.6	13.5	4.1	18.5
ER6AHKXS	66	28	31-1/4	27-5/8	56-3/4	15.8	11.9	3.9	17.8
ET6WSKXK	65-3/4	28	32-3/8	27-3/4	57	15.8	11.9	3.9	17.6
ET5WSEXK	62-3/4	28	32-7/8	27-3/4	57	14.5	10.7	3.8	16.5
ET4WSKXK	62-1/8	28	31-1/2	27-3/4	57	14.4	10.6	3.8	16.3
ETOWSRXM	59-7/8	24	26-7/8	23-3/8	48-3/8	9.6	6.9	2.7	11.9
GB2SHDXP	68-5/8	32-5/8	32-1/2	27-1/2	62-1/2	22.1	15.7	6.4	24.3
GB9SHDXP	65-5/8	29-5/8	32-1/2	27-1/2	59-1/2	18.6	12.9	5.7	21.9
GB9SHKXM	65-5/8	29-5/8	32-1/2	27-1/2	59-1/2	18.6	12.9	5.7	21.9

NOTE: Add 1/4" for hinge cover on bottom-mount model GB9SHKXM. Dimensions shown are for planning purposes only. For complete information, see installation instructions packed with product.

Warranty Information

1-Year Limited Warranty, Parts and Labor.

For complete details, please see the Use & Care Guide packed with product, ask your dealer or visit www.whirlpool.com.



www.whirlpool.com

Call toll free: 1-800-253-1301, 8-6pm EST, Monday-Friday for customer service and Home Economist advice.
Authorized Whirlpool dealers may call 1-800-643-3444 for additional Whirlpool literature.