

Miele

TOUCHTRONIC 

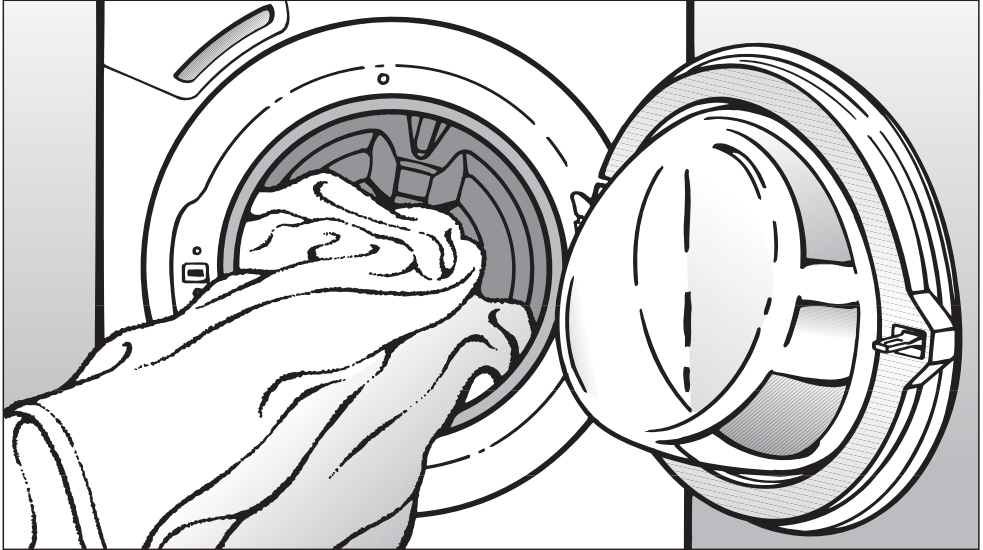

Operating and Installation Instructions Washer W 4802

To prevent accidents and
machine damage,
read these instructions

before
installation or use.

en - US

M.-Nr. 07 459 540

Contents

IMPORTANT SAFETY INSTRUCTIONS	4
Guide to the washer	7
Control panel	7
Before using for the first time	8
Washing tips:	9
Using the washer	10
1. Prepare and sort the laundry	10
2. Load the laundry	11
3. Select a program	12
4. Select a temperature and final spin speed	12
Program guide	13
Final spin speed	15
5. Select an option	16
6. Add detergent	17
Detergents	19
Fabric after care	20
7. Start the program	21
8. Activate the Child Lock	21
9. Program end	22
Canceling a program	23
Interrupting a program	23
Changing a program	23
Adjusting the temperature	23
Adjusting the spin speed	23
Changing an option	23
Adding/removing laundry during a wash program	24
Quick guide	27
Cleaning and care	27
Cleaning the exterior and control panel	27
Cleaning the drum	27
Cleaning the dispenser drawer	28
Cleaning the water inlet filters	30

Frequently asked questions	31
A wash program cannot be started	31
The program was canceled, the buzzer sounds and the "Start" button flashes.	32
An error message is displayed at the end of a program.	33
General problems with the washer	34
Unsatisfactory wash results	35
The drum door cannot be opened.	36
After sales service	39
Installation instructions	41
Installation	42
Installation site	44
Removing the shipping struts	45
Leveling the washer	46
Plumbing	47
Electrical connection	50
Help protect our environment	51

IMPORTANT SAFETY INSTRUCTIONS

 **WARNING** - To reduce the risk of fire, electric shock or injury to persons while using your appliance follow basic safety precautions, including the following:

Read all instructions before installation or use to prevent injury and appliance damage.

This appliance conforms to all uniform safety codes and regulations.

Keep these operating instructions in a safe place and pass them on to any future user.

SAVE THESE INSTRUCTIONS

Correct usage

▶ Only use the washing machine to wash items which are specified by the manufacturer to be machine washable on the fabric care label. Any other applications may be dangerous.

▶ Persons who lack physical, sensory or mental abilities, or experience with the appliance should not use it without supervision or instruction by a responsible person.

Children

▶ Do not allow children to play on or in the appliance. Close supervision is necessary when the appliance is used near children.

▶ The drum door glass will be hot when washing at very high temperatures.

Do not touch the glass. Danger of burns! Keep children away from the washer when in use.

IMPORTANT SAFETY INSTRUCTIONS

Technical safety

▶ Do not install or use a washer with visible damage.

▶ Before connecting the machine, ensure that the connection data on the data plate (fusing, voltage and frequency) match the mains electrical supply. If in doubt contact an electrician.

▶ GROUNDING INSTRUCTIONS

This appliance must be grounded. In the event of malfunction or breakdown, grounding will reduce the risk of electric shock by providing a path of least resistance for electric current. This appliance is equipped with a cord having an equipment- grounding conductor and a grounding plug. The plug must be plugged into an appropriate outlet that is properly installed and grounded in accordance with all local codes and ordinances.

▶ **WARNING** - Improper connection of the equipment-grounding conductor may result in a risk of electric shock. Check with a qualified electrician if you are in doubt as to whether the appliance is properly grounded.

▶ Do not modify the plug provided with the appliance - if it will not fit the outlet, have a proper outlet installed by a qualified electrician.

▶ Do not use an extension cord to connect this appliance to the power supply. Extension cords do not guarantee the required safety of the appliance (e.g. danger of overheating).

▶ Faulty components must only be replaced with genuine Miele spare parts.

▶ Installation, repair and maintenance work should be performed by a Miele authorized service technician. Work by unqualified persons could be dangerous and may void the warranty.

▶ Do not repair or replace any part of the appliance or attempt any servicing unless specifically recommended in these operating instructions.

▶ If the power cord is damaged it must only be replaced by a Miele Service technician with a genuine Miele power cord.

▶ Before servicing, cleaning or in the event of a fault, disconnect the appliance from the main power supply.

▶ Only use a new hose kit to connect the washer to the water supply. Old hosing should not be re-used.

▶ Under certain conditions, hydrogen gas may be produced in a hot water system that has not been used for 2 weeks or more. **HYDROGEN GAS IS EXPLOSIVE.** If the hot water system has not been used for such a period, turn on all hot water faucets and let the water flow from each for several minutes before using the washing machine. This will release any built-up hydrogen gas. Do not smoke or use an open flame during this time, the gas is flammable.

▶ Before the appliance is removed for service or discarded, remove the door.

IMPORTANT SAFETY INSTRUCTIONS

Safety

▶ Do not install or store this appliance where it will be exposed to the weather.

▶ Do not install the washing machine in rooms where temperatures below freezing may occur.

▶ Before using the washer for the first time, remove the shipping struts at the back of the appliance (see "Installation - Removing the shipping struts"). Failure to remove the shipping struts can damage the washer and surroundings during spinning.

▶ During extended absences (e.g., vacation), close the water supply.

▶ **Danger of flooding!**
Before hanging the drain hose in the sink, make sure the water will drain away quickly enough.
Secure the hose. The force of the water exiting the hose can cause an unsecured hose to pop out of the sink.

▶ Ensure that no foreign objects are left in pockets (e.g. nails, coins, paper clips, etc.) this can cause damage to clothes and the machine.

▶ Proper dosing of the detergent will eliminate the need to remove lime deposits. However, if heavy limescale does form on the washer, select a descaling agent with corrosion protection. Closely follow the instructions on the product package.

▶ Do not wash articles that have been previously cleaned, washed, soaked or spotted with gasoline, dry-cleaning solvents or other flammable substances. These articles give off vapors that could ignite or explode. Do not add these items to the wash load.

▶ Do not add gasoline, dry-cleaning solvents, or other flammable or explosive substances to the wash water. These substances give off vapors which could ignite or explode.

▶ Do not use cleaning solvents on or near the machine or the controls. Contact with cleaning solvents will damage the surface.

▶ Do not reach into the appliance if the drum is moving.

▶ Do not tamper with the controls.

Accessories

▶ Only use genuine Miele accessories. If unapproved parts are used, guarantee, performance and product liability claims may become void.

**SAVE THESE INSTRUCTIONS
AND REVIEW THEM
PERIODICALLY**

Control panel

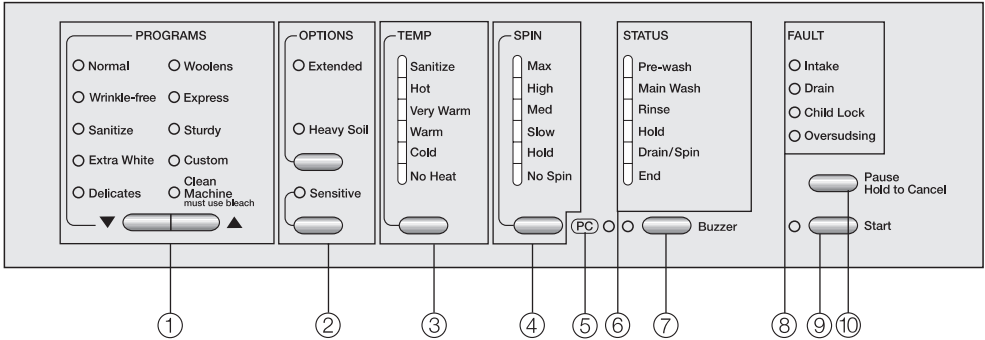

① **PROGRAMS buttons ▼▲**

to select a wash program.

② **OPTIONS buttons**

Special features to enhance a wash program.

③ **TEMP button**

to select the wash temperature.

④ **SPIN speed button**

to select the spin speed.

⑤ **PC Indicator**

allows a service technician to check and update the wash programs.

⑥ **STATUS indicators**

shows the current cycle of the wash program.

⑦ **Buzzer button** turns the buzzer on and off.

⑧ **FAULT indicators**

indicate errors and shows the activated Child Lock.

⑨ **Start button**

starts the selected wash program.

⑩ **Pause/Hold to cancel button**

pauses or cancels a program.

Before using for the first time

The appliance must be correctly installed and connected before the first use. Please see the "Installation instructions."

This washing machine has undergone thorough testing in the factory, there may be some residual water in the drum from this process.

Running a spin cycle before the first use is not possible for safety reasons.

To activate the spin cycle, a wash program must be run **without laundry and without detergent**.

- Turn on the water supply.

The washer is ready for the first use. The "Normal" program indicator lights.

- Press the "Start" button.

Once the program has finished the first use is complete.

Before using for the first time

Washing tips:

Energy and water consumption

- Do not overload the washer. The energy and water consumption will be most energy efficient.
- With smaller loads in the programs "Normal, Sanitize, Extra White and Custom" the washer automatically adjusts the water use to conserve water and energy.
- If applicable use the program "Normal - Very Warm" instead of "Sanitize". It saves between 35% and 45% energy. For most soiling, this is sufficient. For stubborn soiling use the option "Heavy Soil".

Detergent use

- Use the recommended amount of detergent.
- Bear in mind the soiling degree of the laundry.
- Use less detergent for small loads.

Options selection (Extended, Heavy Soil)

Select for:

- For light to normal soiled items without stains use a wash program without an option.
- For normal to heavily soiled items with stains wash with the "Extended" option.
- For heavily soiled items use a wash program with the "Heavy Soil" option and "Extended".
- Items with larger soiling, e.g. dust, sand, use a program with the option "Heavy Soil".

Tip: If you will be using a tumble dryer to dry the laundry

- Select the highest spin speed suitable for the wash load to remove as much water as possible to save energy when tumble drying.

Using the washer

1. Prepare and sort the laundry

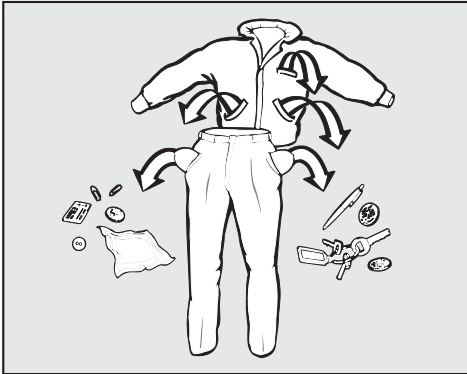

- Empty all pockets.

 Foreign objects left in pockets (e.g. nails, coins, paper clips, etc.) can cause damage to clothes and the machine.

Pretreat stains

- Tough stains (blood, egg, coffee, tea, etc.) or badly soiled areas (collars and cuffs) should be pretreated with a stain remover or a paste made from powder detergent and warm water. Dab stains with a damp light colored cloth. Do not rub!

 Do not use chemical solvents in the machine.

Sort the laundry

- Only wash items that are labeled machine washable by the manufacturer. Most garments have a fabric care label in the collar or side seam.
- Sort the laundry by care label and color.

General tips

- Dark fabrics often bleed the first few times they are washed. They should be washed separately several times before being included in a mixed load.
- Curtains: Remove any lead weights or strips before washing.
- Loose bra underwires should be removed or sewn in place before washing.
- Woolens, knitted garments, jeans, pants and sweat shirts should be turned inside out.
- Close zippers, hooks and eyelets before washing.
- Comforter covers and pillowcases should be fastened to prevent small items from rolling inside of them.
- **Do not** wash items with the  symbol on the fabric care label.

2. Load the laundry

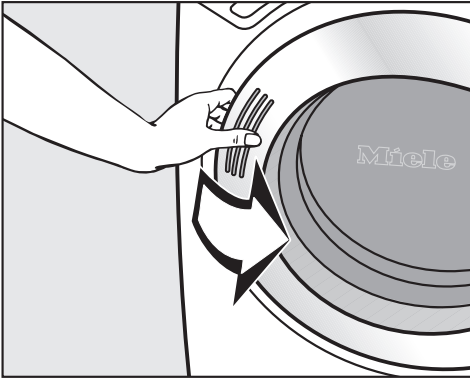

- Open the drum door.
- Load the laundry loosely into the drum. For best results, wash mixed loads of small and large items. This will improve washing effectiveness and help distribute the load evenly.

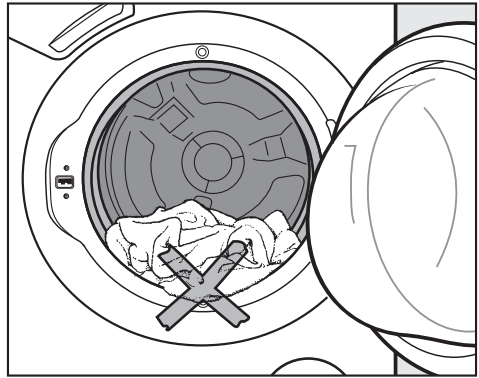

- Close the drum door. To prevent damage, make sure that there is no clothing caught between the drum door and the seal.

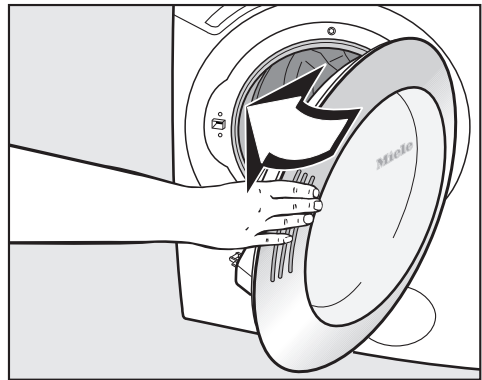

- Close the drum door.

Using the washer

3. Select a program

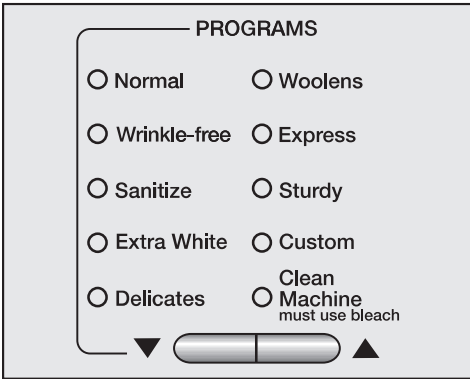

- Press the "PROGRAMS" button ▼ or ▲ until the desired program indicator lights.

4. Select a temperature and final spin speed



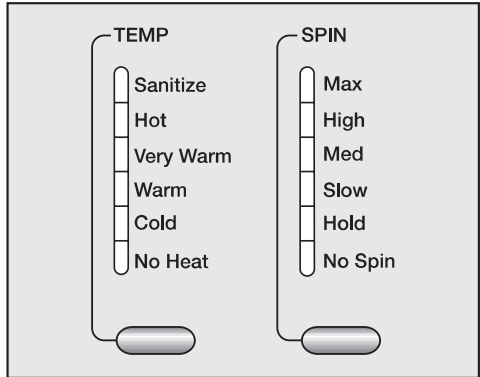











The preselected temperature and/or spin speed can be adjusted if the program allows for it. See the "Program Guide".



- Press the "TEMP" and "SPIN" button until the indicator of the desired setting lights.







Using the washer

Program guide

Temperature		Final Spin	Item / Tip
Normal		Options: Extended, Heavy Soil, Sensitive, Buzzer	
Hot		Max	Items made from cottons, linen or mixed fabrics. Important: Fill the drum only $\frac{3}{4}$ of the way. Items need room to move otherwise they might get caught in the drum door seal.
Sanitize			
Warm			
Cold			
No Heat			
Wrinkle-free		Options: Extended, Heavy Soil, Sensitive, Buzzer	
Hot		Max High	Items made from synthetics, mixed fabrics or wrinkle free cottons.
Very warm			
Warm			
Cold			
No Heat			
Sanitize		Options: Extended, Heavy Soil , Sensitive, Buzzer	
Sanitize		Max High	Items which have come in contact with the skin or have special hygienic requirements.
Hot			
Extra White		Options: Extended, Heavy Soil, Sensitive, Buzzer	
Hot		Max High	For white items without special hygienic requirements.
Very warm			
Delicates		Options: Extended, Buzzer	
Warm		Med Slow Hold No spin	For delicate items made from synthetics.
Cold			
No Heat			

The default settings are highlighted in **bold**.

Using the washer

Temperature		Final Spin	Item / Tip
Woolens		Options: Sensitive, Buzzer	
Warm		High Med Slow Hold No Spin	Items made from washable wool and mixed woolens.
Cold			
No Heat			
Express		Options: Buzzer	
Warm		Max High Med Slow Hold No Spin	Small loads of mixed items without a high degree of soiling.
Cold			
No Heat			
Sturdy		Options: Extended, Heavy Soil, Sensitive, Buzzer	
Warm		High Med Slow	All items made from denim Before washing denim items turn them inside out.
Cold			
No Heat			
Custom		Options: Extended, Heavy Soil, Sensitive, Buzzer	
Sanitize		Max High Med Slow Hold No Spin	All options freely selectable for Sanitize and Normal items
Hot			
Sanitize			
Warm			
Cold			
No Heat			
Clean Machine		Options: Buzzer	
Sanitize		Max	To clean the drum and all waterways. Run program without laundry.

Final spin speed

Program	
Normal	Max
Wrinkle-free	High
Sanitize	Max
Extra White	Max
Delicates	Med
Woolens	High
Express	Max
Sturdy	High
Custom	Max
Clean Machine	–

The final spin speed can be reduced, if the program allows changes. The selection of a final spin speed higher than that shown above is not possible.

Rinse spin

The laundry is spun after the main wash and between rinse cycles. Reducing the final spin speed will also reduce the rinse spin speeds.

Hold

- Select "Hold". The laundry is not spun and remains soaking in water. This will prevent wrinkles if the laundry is not removed immediately at the end of the wash program.

– **Selecting / Starting the final spin**

The washer is set by default to the maximum spin speed of the wash program.

- You can select a lower spin speed. Press "Start" to start the final spin.

– **Finishing the program**

- Press the "Pause" button until the program ends.

No spin

(Deselect rinse spin and final spin)

- Select "No Spin". The water is drained away after the last rinse.

Using the washer

5. Select an option

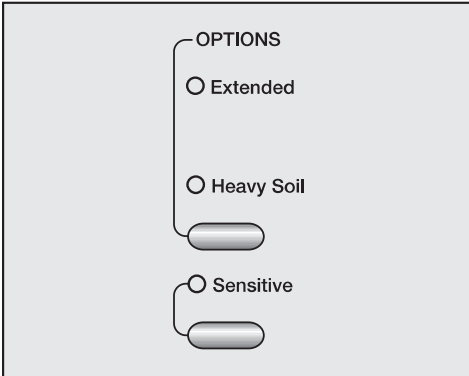

- Select the desired Option with the respective button. Once an Option is selected the indicator lights.
- See the Program Guide to find which Option is selectable for what program.

If an Option cannot be selected, the wash program does not permit it.

Extended

For laundry with normal to heavy soiling or stains.

The main wash cycle time for the wash program will be extended.

Heavy Soil

For heavily soiled laundry. For stubborn stains which are dried on.

A pre-wash takes place and the wash time for the main wash is extended.

Sensitive

An additional final rinse that washes away detergent residue and scents.

Buzzer

A buzzer sounds the end of the wash program or after "Hold". The buzzer sounds until the washer is turned off.

6. Add detergent

Front loading washing machines require significantly less detergent than traditional top loaders. Closely follow the requirements of the detergent manufacturer.

Use detergent according to the laundry soiling and water hardness.

Light soiling

No soiling or stains are visible.

Normal soiling

Some visible soiling or a few light stains.

Heavy soiling

Very visible soiling or stains.

Use the "Heavy soil" function and add detergent in the Heavy soil compartment as described.

Too little detergent may cause:

- Ineffective cleaning of laundry; fabrics may become gray and stiff over time.
- Grease stains on the laundry.
- Hard water deposits on the heating element.

Too much detergent may cause:

- Over sudsing with minimal drum movement; poor wash, rinse and spin results.
- Higher water consumption through an automatic, additional rinse cycle.
- Higher environmental burden.

Using the washer

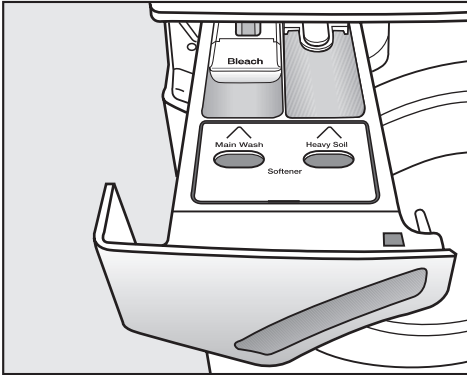

- Pull out the detergent dispenser drawer.

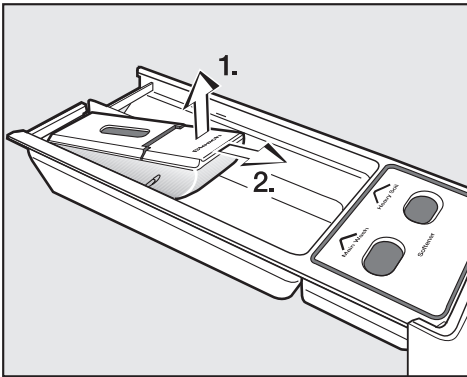

- If you do not use bleach, please remove the insert from the main wash compartment.

- Add detergent to the desired compartments.
 - **Main wash**
Detergent for the main wash
 - **Heavy Soil**
Detergent for the pre-wash
 - **Bleach**
Bleach used as described by the manufacturer; placed in the bleach compartment
 - **Softener**
Fabric softener or liquid starch
- Add detergent to the Main Wash compartment at the beginning of each wash program.
- Only add detergent ($\frac{1}{4}$ total recommended amount) to the "Heavy Soil" compartment, if the "Heavy Soil" option was selected.
- Close the detergent drawer.

Detergents

You can use all **high efficiency detergents** which are formulated for household washing machines. Closely follow the requirements of the detergent manufacturer.

	Universal	Color	Delicate	Special	Bleach	Fabric Softener
Normal	X	X	–	–	X	X
Wrinkle-free	X	X	–	–	X	X
Sanitize	X	–	–	–	X	X
Extra White	X	–	–	–	X	X
Delicates	–	–	X	X	X	X
Woolens	–	–	–	X	–	–
Express ¹⁾	X	X	–	–	–	X
Sturdy ¹⁾	X	X	X	X	X	X
Custom	X	X	–	–	X	X
Clean Machine	–	–	–	–	X	–

¹⁾ only liquid detergent

Miele offers a variety of specialized laundry detergents and fabric softeners, each uniquely designed to meet your individual laundry care needs. For more information visit the Miele.com web site.

Using the washer

Fabric after care

Fabric softener

Makes fabrics feel softer and reduces static cling in the dryer.

Mild liquid starch

A synthetic starch wash that gives fabrics some stiffness.

Starch

Gives the fabrics stiffness and volume.

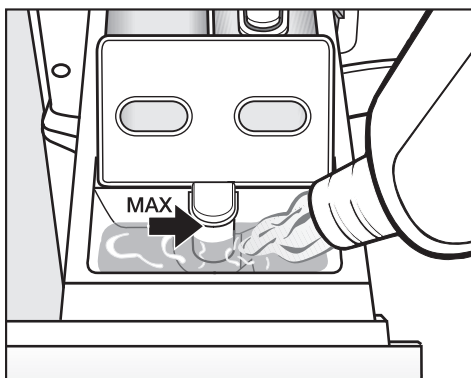

- Add the fabric softener or mild liquid starch to the "Softener" compartment. **Do not exceed the maximum fill level marked inside the compartment.**

The fabric softener / liquid starch will be dispensed during the final rinse. A small amount of water will remain in the compartment at the end of the program.

If starching frequently, clean the dispenser compartment and especially the siphon tube.

Bleach

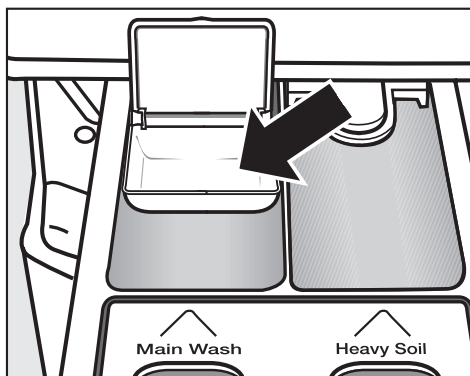

- Pour bleach into the bleach compartment.

During the Main Wash the bleach will be automatically rinsed from the compartment and added to the cycle.

Dyes / Dye removers

The use of dyes in the washer is recommended only to a degree of usual household use. The salt used for dyeing may corrode the stainless steel with frequent use.

- Use as directed by the manufacturer.

⚠ Do not use dye removers in this washer!

7. Start the program

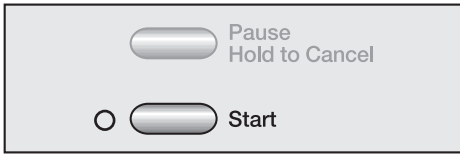

- Press the flashing "Start" button.

When pressing the "Start" button, do not press and hold the button. Only a brief tap is necessary.

The washer shows the current cycle of the wash program under "STATUS".

The drum door will be locked when the program starts.

The drum light turns off after the program starts.

 If a program was started without detergent, cancel the program first. Add detergent, then select and start a program again.

8. Activate the Child Lock

(if desired)

The Child Lock prevents a program from being canceled.

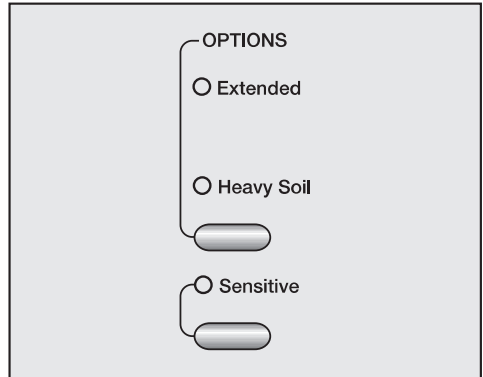

- Press the "OPTIONS" button until the "FAULT" indicator "Child Lock" lights.

Deactivate the Child Lock

- Press the "OPTIONS" button until the "FAULT" indicator "Child Lock" goes out.

Once the program has finished, the Child Lock must be deactivated.

Using the washer

9. Program end

- Open the drum door.
- Remove the laundry.

Check the drum for any missed pieces of laundry. Items inadvertently left in the washer may be damaged (e.g. shrink or discolor) during the next wash cycle.

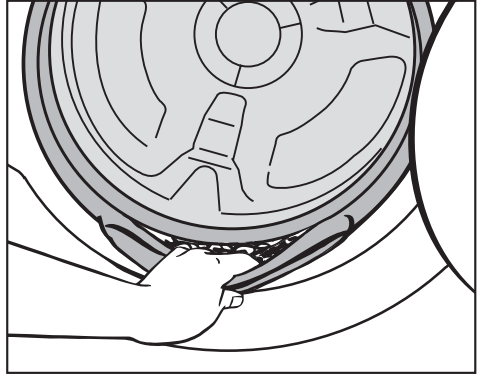

- Check the folds of the door seal for any small articles which may have been trapped.
- Close the drum door.
- Activate the Child Lock for safety reasons.

 Children, animals or foreign objects may find their way into the drum. Danger of injury and damage to the machine!

Canceling a program

A program can be canceled any time after a program start.

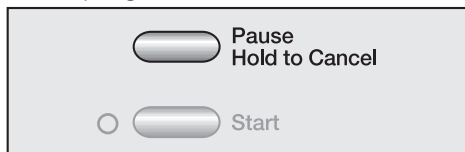

- Press the "Pause" button until the "STATUS" indicator "Drain/Spin" indicator lights. The wash water will be drained away.

To add or remove laundry

- Open the drum door.

To select another program

- Select a new program with the ▼▲ buttons.

Interrupting a program

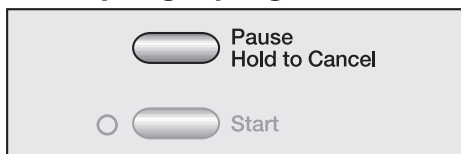

- Press the "Pause" button briefly.

The washer interrupts the program and unlocks the door.

Continue:

- Tap the "Start" button.

Changing a program

A program change is not possible after a program has started. To change a program, the program must be canceled first.

Adjusting the temperature

The temperature can be changed up to 6 minutes after the program start.

Adjusting the spin speed

The spin speed can be adjusted anytime until the beginning of the final spin.

Changing an option

The options "Extended or Sensitive" can be selected up to 6 minutes after the program start.

The "Buzzer" can be selected or deselected at any time.

Using the washer

Adding/removing laundry during a wash program

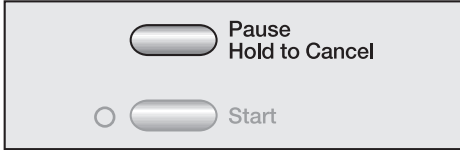

- Press briefly the "Pause" button.
- Open the drum door.
- Add or remove the piece of laundry.
- Close the drum door.
- Press the "Start" button.

The program will continue automatically.

The drum door cannot be opened if:

- the water temperature is greater than **130°F (55°C)**.
- the water level is too high.
- the program has reached the "Final Spin".
- The Child Lock function is activated.

Miele

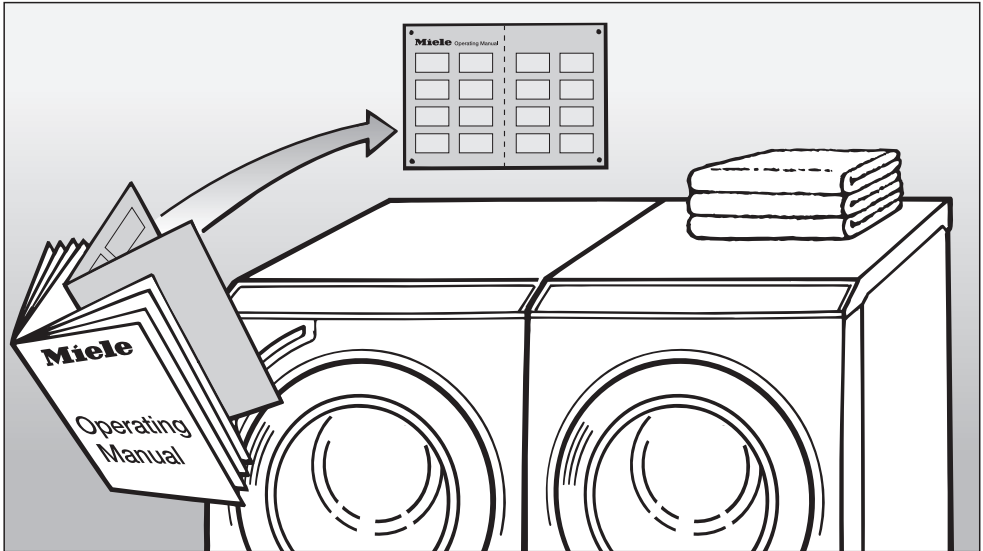

Quick guide

Remove this guide for easy reference

Please read all instructions, especially the "Important Safety Instructions", before using the washer.

Quick guide

1. Sort the laundry

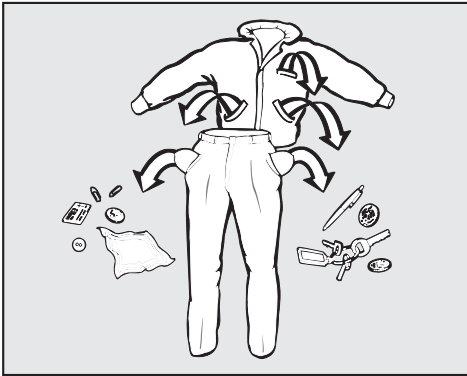

- Empty all pockets.
- Sort the laundry by fabric and color.
- pretreat stains.

2. Load the laundry

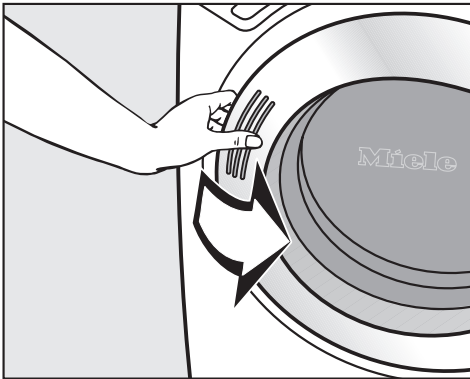

- Open the drum door and load the laundry.
- Close the drum door.

To prevent damage to the door seal and clothing, make sure no clothing is caught between the drum door and seal.

3. Select a program

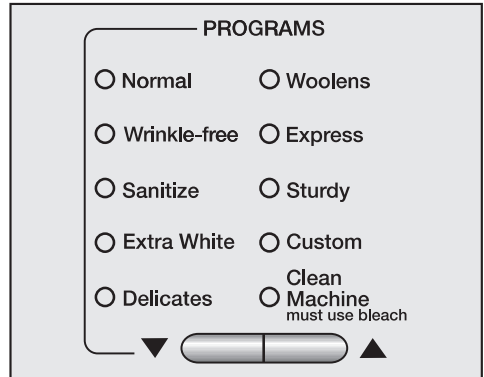

- Select the desired program.

The indicator of the selected program lights.

4. Select a temperature and spin speed

The preselected temperature and/or spin speed can be adjusted if the program allows so.

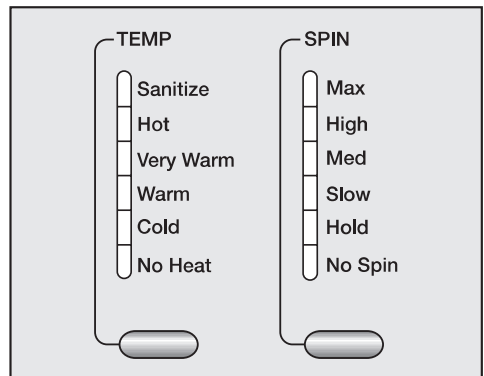

- Press the "TEMP" and "SPIN" button until the indicator of the desired setting lights.

5. Select an Option

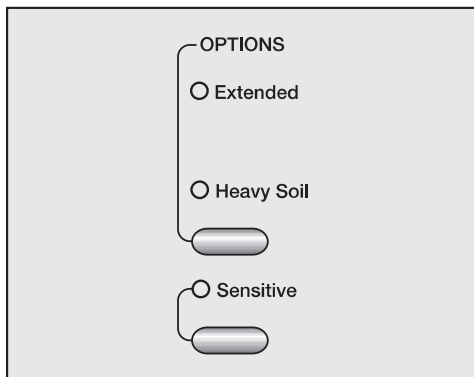

- Select the desired "OPTIONS". Press the upper button until the indicator/s of the desired option light/s.

6. Add detergent

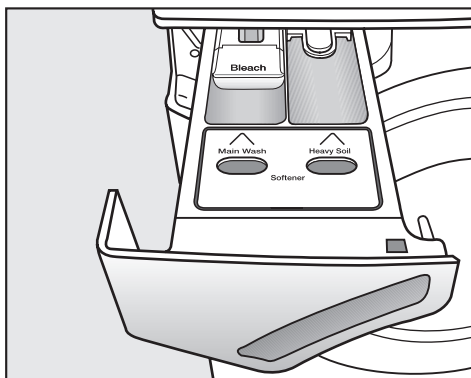

- Add detergent in the respective compartments.

7. Start a program

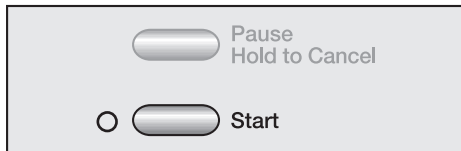

- Tap the flashing "Start" button.

8. Activate the Child Lock

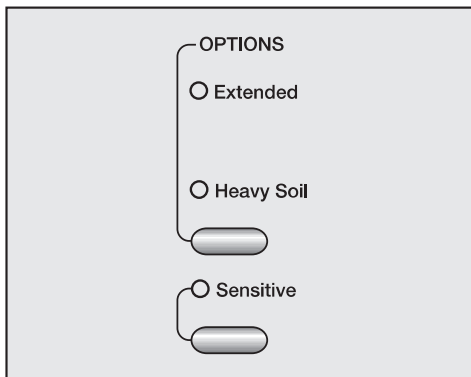

- Press the "OPTIONS" button until the "FAULT" indicator "Child Lock" lights.
- Deactivate the Child Lock after the program has finished.

9. Unload the laundry

- Open the drum door.
- Remove the laundry.

Check the drum for any missed pieces of laundry. Items inadvertently left in the washer may be damaged (e.g. shrink or discolor) during the next wash cycle.

Quick guide

Program guide

	Sanitize	Hot	Very Warm	Warm	Cold	No Heat	Max	High	Med	Slow	Hold	No Spin
Normal			X	X	X	X	X	X				
Wrinkle-free			X	X	X	X	X		X	X		
Sanitize	X	X						X	X			
Extra White			X	X				X	X			
Delicates					X	X	X			X	X	X
Woolens					X	X	X		X	X	X	X
Express					X	X	X	X	X	X	X	X
Sturdy					X	X	X		X	X		
Custom		X	X	X	X	X	X	X	X	X	X	X
Clean Machine	X											

Options

	Normal	Wrinkle-free	Sanitize	Extra White	Delicates	Woolens	Express	Sturdy	Custom	Clean Machine
Extended	X	X	X	X	X	X			X	X
Heavy Soil	X	X	X	X	X				X	X
Sensitive	X	X	X	X	X		X		X	X
Buzzer	X	X	X	X	X	X	X	X	X	X

The default settings are highlighted in **bold**.

⚠ Before cleaning or maintenance, disconnect the power supply by unplugging the unit or manually "tripping" the circuit breaker.

⚠ Do not hose the washer down.

Cleaning the exterior and control panel

- Clean the exterior of the washer with a mild solution of non-abrasive detergent or soap and water, then wipe dry with a soft cloth.
- Clean the drum with a stainless steel cleaner specially formulated for use on washing machines (available from Miele).

⚠ Do not use chemical solvents, abrasive cleaners, glass or all-purpose cleaners! They will damage the surface.

Cleaning the drum

To ensure that your machine remains clean and free of any soil build-up or odors, the washer comes equipped with a self-cleaning program for the drum and water lines. It is suggested to run this program approx. once a month.

The program is done **without laundry** in the machine.

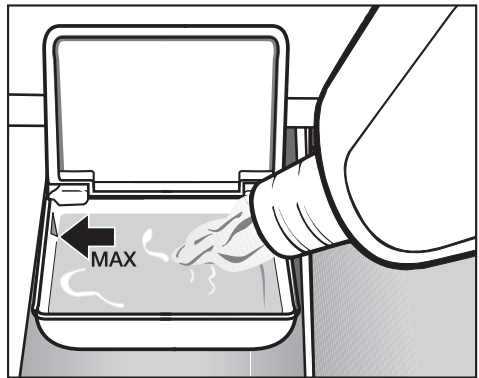

- Load approx. ½ cup of bleach into the *Bleach* compartment. Do not exceed the max. fill mark (small triangle on the sides).
- Close the door.
- Select the *Clean Machine* program.
- Press the *Start* button.

Once the program is finished:

- Clean the dispenser drawer as described on the following pages.

Cleaning and care

Cleaning the dispenser drawer

Regularly remove any detergent residue.

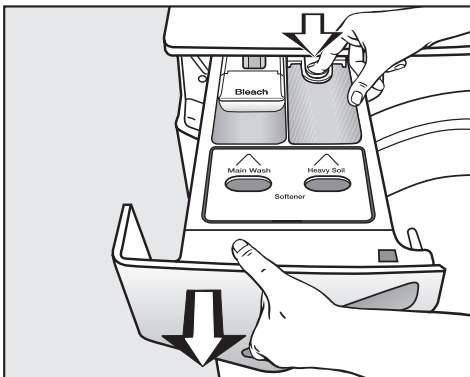

- Pull the detergent drawer out until it stops, press down the release catch, and remove the drawer from the washer.

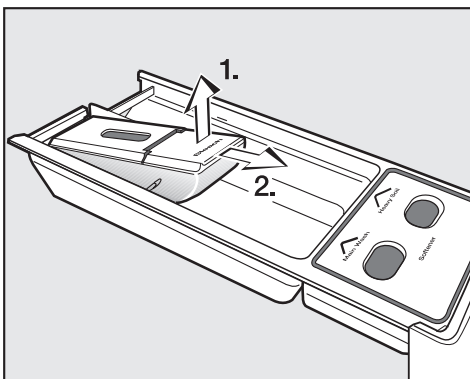

- Remove the bleach compartment to clean it.

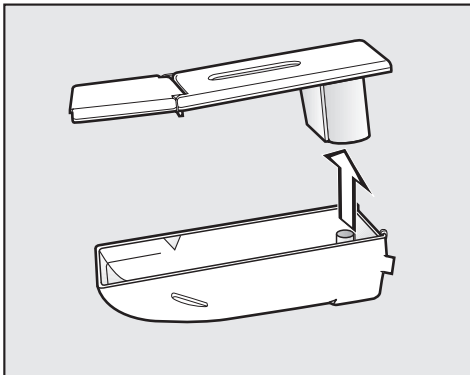

- Remove the lid from the bleach container and clean both parts thoroughly in warm water.
- Re-attach the lid.
- Clean the "Heavy Soil" and "Main Wash" compartments with warm water.
- Put the bleach container back in the "Main Wash" compartment.

Siphon tube and channel

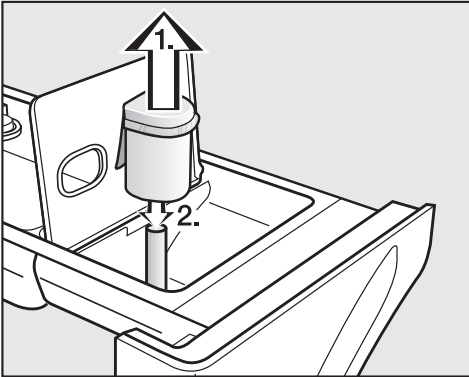

1. Remove the siphon tube from the "Softener" compartment and rinse under warm water. Also clean the pipe connected to the siphon tube.
2. Put the siphon tube back into place.

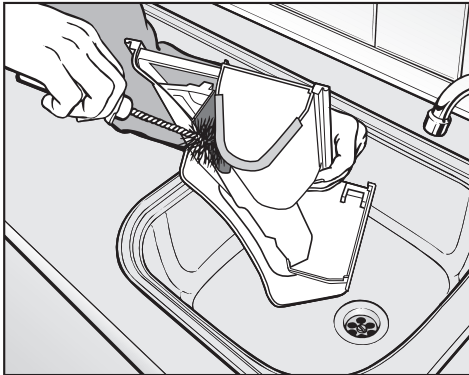

- Clean the fabric softener channel with warm water and a brush.

Clean the siphon tube and fabric softener channel more often if you frequently use liquid starch. Liquid starch tends to build up.

Cleaning the detergent drawer niche

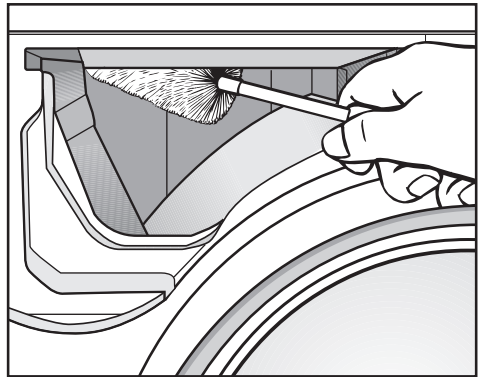

- Use a bottle brush to remove any detergent residue and lime deposits from the jets inside the detergent drawer.
- Slide the drawer back into place.

Cleaning and care

Cleaning the water inlet filters

The washer has two water inlet filters to protect each inlet valve. These filters should be checked and cleaned if necessary every 6 months. This may need to be done more frequently with some water supplies.

- Turn off the water supply.
- Unscrew the inlet hose from the valve by turning the connector counter-clockwise using a wrench if necessary.

- Remove the rubber seal, **1**, from the connector.
- Using needle nose pliers, grasp the

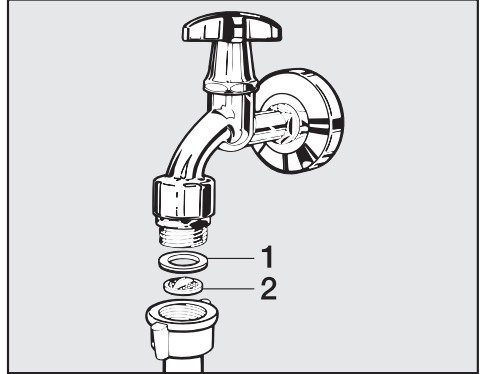

plastic filter, **2**, and pull it out of the hose connector.

- Clean the filter under running water and carefully remove any large particles.
- Replace the filter and seal then reconnect the hose.
- Slowly turn on the valve and check for leaks. If water leaks, tighten the bolt.

Both filters **must** be put back in place after cleaning.

Frequently asked questions

 Repairs to electrical appliances must only be carried out by a qualified and trained person in accordance with local and national safety regulations. Repairs and other work by unqualified persons could be dangerous. The manufacturer cannot be held responsible for unauthorized work.

The following section will help you avoid placing a service call by identifying issues you may encounter while operating the machine:

A wash program cannot be started		
Issue	Possible cause	Solution
A "PROGRAMS" indicator does not light and the "Start" button does not flash.	The washer has no power.	Check to determine if: <ul style="list-style-type: none">– the washer is plugged in.– the circuit breaker has been tripped.
Immediately after the program start the washer cancels the program.	The "child entrapment sensor" has reacted.	<ul style="list-style-type: none">■ Open the drum door.■ Check the drum for small children or animals.■ Restart the program.

Frequently asked questions

The program was canceled, the buzzer sounds and the "Start" button flashes.		
Issue	Possible cause	Solution
		<ul style="list-style-type: none"> – To turn off the fault message: Open the drum door or press and hold the "Pause/Hold to Cancel" button until the fault message goes out.
The "FAULT" indicator "Drain" lights.	<ul style="list-style-type: none"> – The drain is blocked. – The drain hose is too high. 	<ul style="list-style-type: none"> – Clean the drain filter and the drain pump. – The maximum drain pump height is 3 ft (1 m).
The "FAULT" indicator "Intake" lights.	The water intake is blocked.	Possible fault: <ul style="list-style-type: none"> – Check if the water supply is open all the way. – the inlet hose is kinked.
The "FAULT" indicators "Intake" and "Drain" light.	The waterproof system has activated.	Call Technical Service.
The "STATUS" indicators "Pre-Wash" and "Main Wash" light.	There is a fault.	Start the program once more. If the fault message appears again call Technical Service.
The buzzer sounds and the "Buzzer" indicator lights.	The door is not closed properly.	<ul style="list-style-type: none"> – Open the door and check for any obstructions. – Close the door. – Press "Pause/Hold to Cancel" for at least 5 seconds. – Press "Start".

Frequently asked questions

An error message is displayed at the end of a program.

Issue	Possible cause	Solution
		<ul style="list-style-type: none"> – To turn off the fault message: Open the drum door or press and hold the "Pause/Hold to Cancel" button until the fault message goes out.
The "FAULT" indicator "Drain" lights.	The drain is blocked.	Clean the drain filter and the drain pump.
The "FAULT" indicator "Intake" lights.	The water intake is blocked.	Possible fault: Check if the water supply is open all the way.
The "FAULT" indicator "Over sudsing" lights.	The machine has over sudsed.	Use less detergent in the next wash program, and follow the recommended amount on the detergent packaging.

Frequently asked questions

General problems with the washer		
Problem	Possible cause	Remedy
The washer shakes during spin cycles.	The feet are not level and/or the nuts are not properly tightened.	Level the machine see, "Installation - Leveling the Washer", and tighten the nuts.
The pump is making unusual noises.	This is not a fault. Lapping sounds at the beginning and end of the pump process are normal.	
Large residues of detergent remain in the dispenser drawer.	The water pressure is too low.	– Clean the water inlet filter.
	Powdered detergents used along with water softeners tend to clump.	Clean the detergent compartment. In the future, first load the detergent into the compartment, followed by the water softener.
Some fabric softener remains behind in the compartment, or there is too much water in the compartment.	The siphon tube is clogged or not positioned correctly.	Clean the siphon (see "Cleaning and care - Cleaning the dispenser drawer").
There is a odor coming from the washer.	Only low-temperature programs have been run.	Run the <i>Clean Machine</i> program to clean the washer (see "Cleaning and care").

Frequently asked questions

Unsatisfactory wash results		
Issue	Possible cause	Solution
The laundry is not clean enough when using liquid detergent.	Liquid detergents do not contain bleaching agents. Fruit, coffee and tea stains may not be removed.	<ul style="list-style-type: none">– Use powder detergents containing bleach.– Pretreat stains
Laundry has a gray sticky residue.	<ul style="list-style-type: none">– Not enough detergent was used to dissolve greasy deposits on heavily soiled laundry.– The laundry was soiled with grease, e.g. oils, lotions, etc.	<ul style="list-style-type: none">– Add more detergent to laundry with grease stains or use a liquid detergent.– Run the "Sanitize" program without laundry using liquid detergent to clean the washer before using it for laundry again.
There is white detergent residue on dark laundry.	The detergent has not completely dissolved because of hard water. These residues are difficult to remove.	<ul style="list-style-type: none">– After drying, remove white residues with a clothes brush.– In the future add a water softener to the detergent.

Frequently asked questions

The drum door cannot be opened	
Possible cause	Solution
The door is locked during the wash cycles.	Press the "Pause" button. The door lock opens.
The Child Lock is activated.	Deactivate the Child Lock as described in the chapter "Using the washer - Activate the Child Lock".
Power failure	Open the door as described on the following page.
There is still water in the drum and the washer cannot drain the water.	Clean the drain filter and drain pump. See "Cleaning and Care - Cleaning the drain pump and lint trap".
As a safeguard against scalding, the drum door cannot be opened if the wash water temperature is over 130°F (55°C).	

Frequently asked questions

Opening the drum door during a power failure or when the drain is blocked

 Pull the plug from the electrical outlet before cleaning the washer!

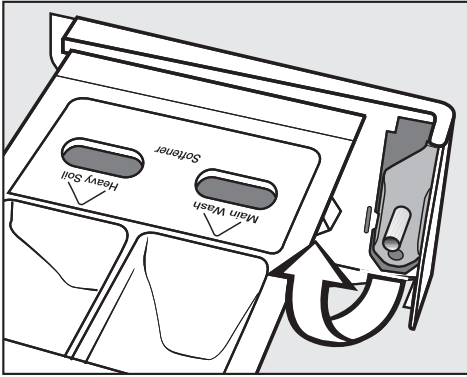

- Open the detergent dispenser drawer and remove the tool.

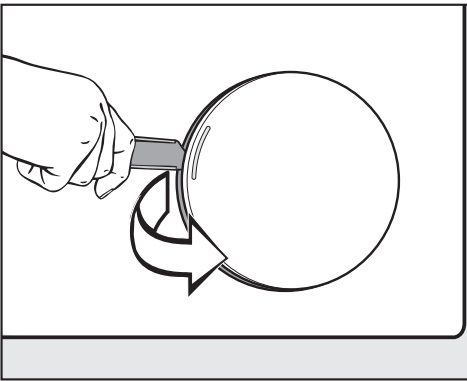

- Open the lint trap door.

If the drain is clogged there will be water in the machine (max. 9.25 gal [35 l]).

 Make sure the machine is turned off and the drum has stopped turning. A moving drum is dangerous.

- Place a container under the drain tube.

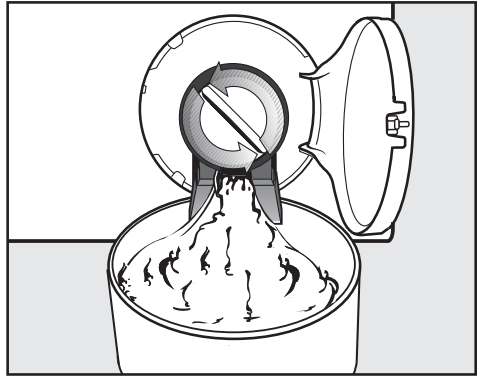

- Open the drain filter until water runs out, but do not take it out completely.
- If the container becomes too full, interrupt the water flow by tightening the drain filter.
- Discard the water and continue.

Frequently asked questions

Once the flow of water stops:

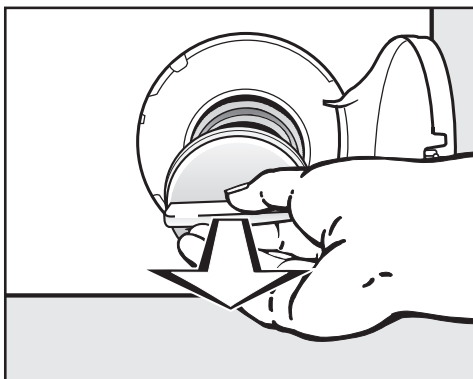

- Remove the drain filter.
- Clean out any foreign objects or lint from the filter.

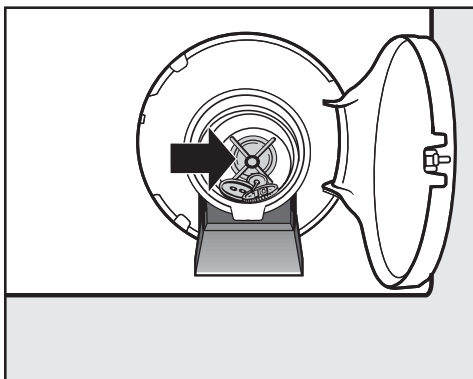

- Check that the drain pump impeller (in the back of the chamber) rotates freely by spinning it with your hand.
- Return the drain filter and tighten it into place.

⚠ If the drain filter is not securely tightened water will leak out when the machine is used.

Opening the drum door

⚠ Make sure the machine is turned off and the drum has stopped turning. A moving drum is dangerous.

- Pull out the detergent drawer.

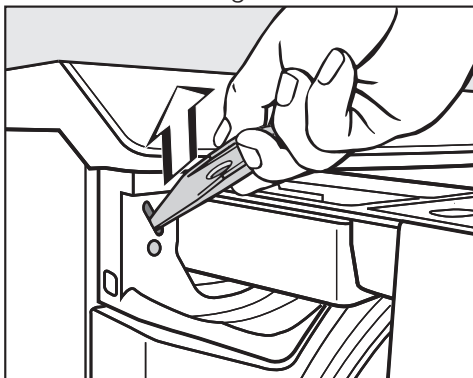

- Insert a screw driver into the slot of the emergency opener and pull upwards. The door will now open.

Repairs

In the event of a fault which you cannot fix yourself, please contact the service number on the back of this manual.

When contacting the Service Department, please quote the model and serial number of your appliance. This information can be found on the data plate located at the door hinge.

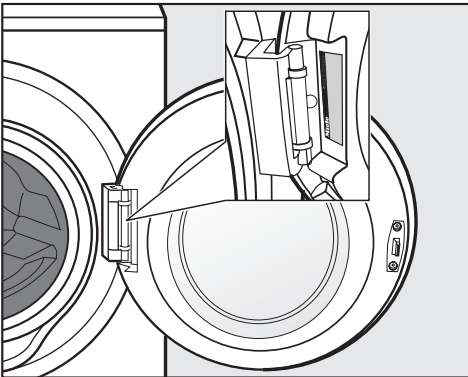

PC Update

The indicator marked PC allows a technician to make use of new technology. When, for example, new programs are developed or new fabrics are introduced, a service technician will be able to modify existing program cycles accordingly.

Miele will provide information when such possibilities become available.

Optional accessories

Optional accessories are available through your Miele dealer or Miele.

MieleCare

(only USA)

MieleCare, our Extended Service Contract program; gives you the assurance of knowing that your appliance investment is covered by 5 years of worry free ownership.

MieleCare is the only Extended Service Contract in the industry that guarantees repairs by a Miele Authorized Service Provider using genuine Miele parts. Only genuine Miele parts installed by factory trained professionals can guarantee the safety, reliability and longevity of your Miele appliance.

Please note that unless expressly approved in writing by the Miele Service department, Extended Service Contracts offered by other providers for Miele products will not be recognized by Miele. Our goal is to prevent unauthorized (and untrained) service personnel from working on your Miele products, possibly doing further damage to them, you and/or your home.

To learn more about **MieleCare** Extended Service Contracts, please contact your appliance dealer or visit us online at:

<http://miele.com/mielecare>

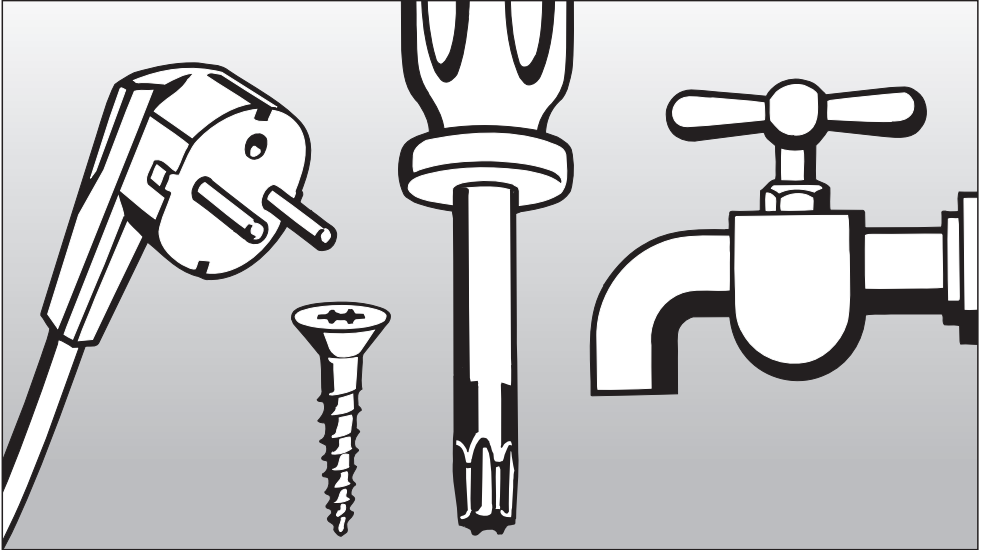

Installation Instructions

To prevent accidents
and machine damage
read these instructions
before
installation or use.

Installation

Front view

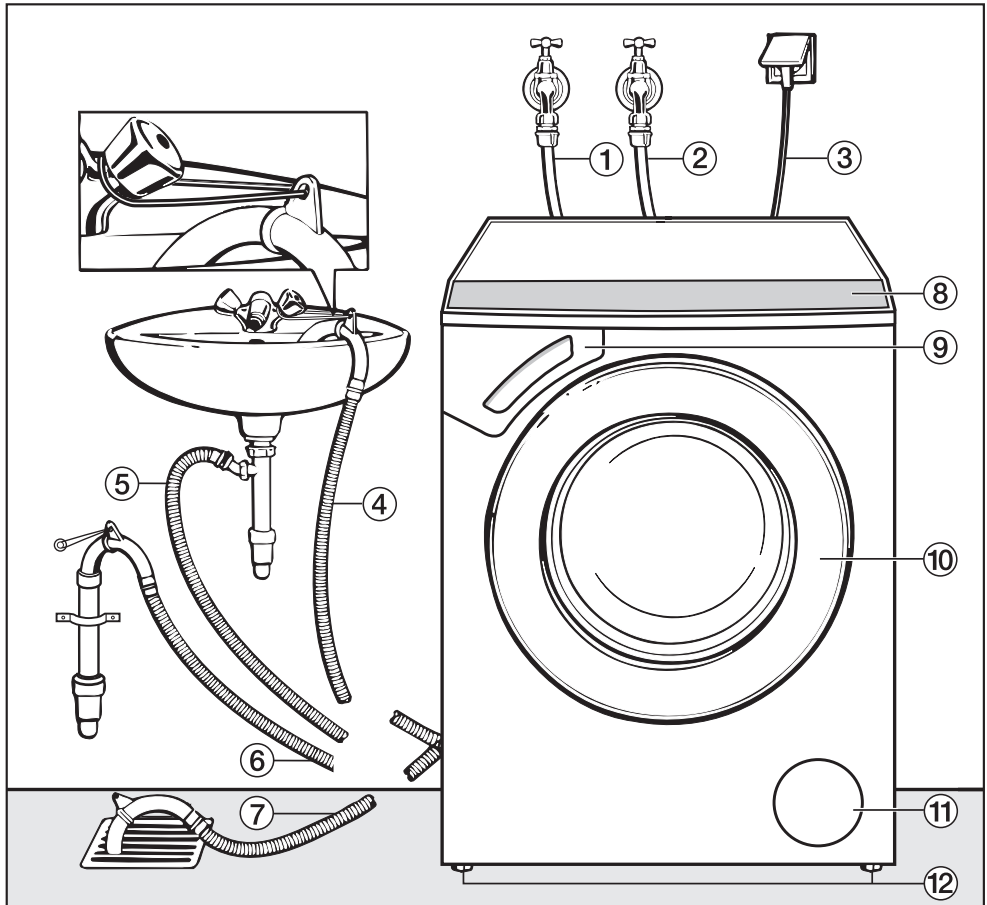

- ① High pressure intake hose, red mark for hot water
- ② High pressure intake hose, blue mark for cold water
- ③ Power cord
- ④ - ⑦ Flexible drain hose with detachable swivel elbow (drain options shown)
- ⑧ Control panel
- ⑨ Detergent dispenser drawer and door opener in case of power failure
- ⑩ Drum door
- ⑪ Access panel to lint trap and drain pump
- ⑫ Four height-adjustable feet

Rear view

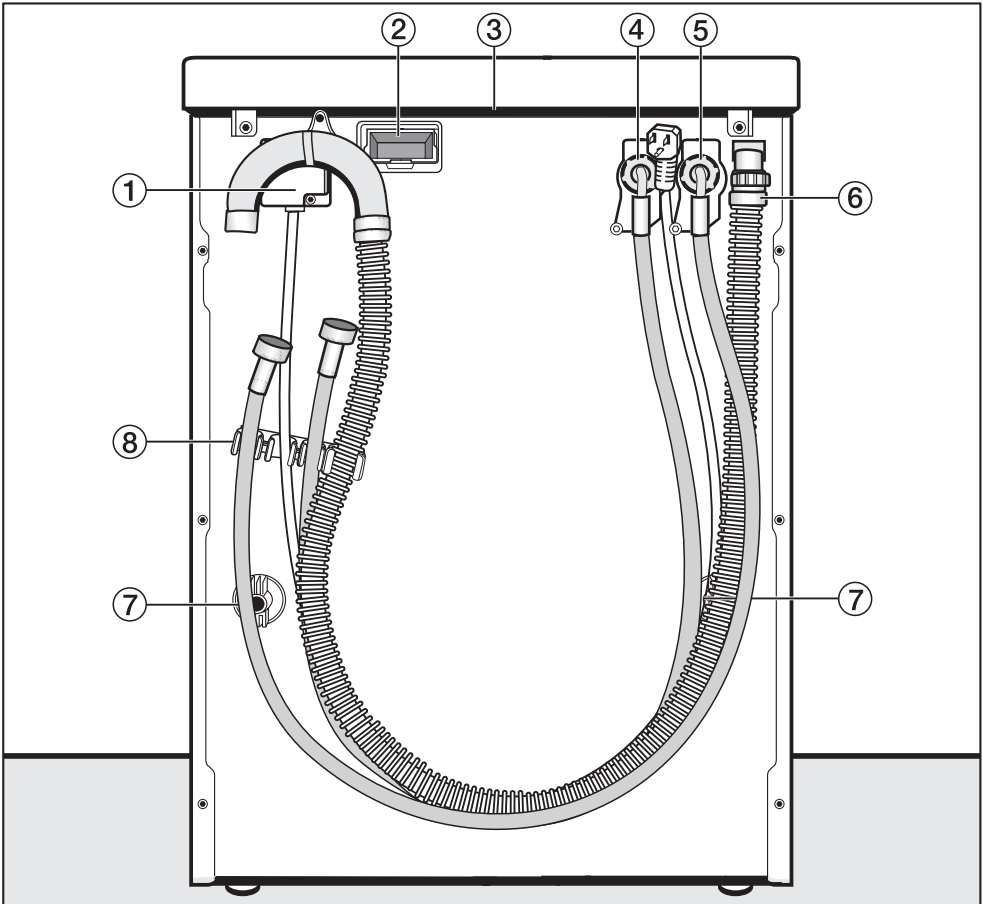

- ① Electrical connection
- ② W-LAN communication module
- ③ Rear access with grip for transport
- ④ Water intake hose cold water (blue stripes)
- ⑤ Water intake hose hot water (red stripes)
- ⑥ Drain hose
- ⑦ Shipping struts
- ⑧ Brackets for intake and drain hoses

Installation

Installation site

For best performance front loading washers should be installed on the ground floor or basement of the building.

A concrete or reinforced floor is the most suitable surface for the washer. These floors are less prone to vibration during the spin cycle.

If the installation must be on a wooden joist floor:

- the corner of a room where the stability of the floor is at its greatest is the best place to install the washer.
 - the machine must be leveled and securely positioned.
 - to avoid vibration while spinning, the machine should not be installed on soft floor coverings.
- Install the unit on a 1 1/4" (32 mm) thick, 28" x 31" (71x78 cm) wide plywood base. Ideally the base should be large enough to span several joists and should be anchored to the joists and not just the floor boards.

 If the machine is installed on a raised platform it must be secured with retaining clips available from your dealer or Miele.
If installed on a masonry or concrete base, the base should have a 1/2" (13 mm) to 3/4" (19 mm) high rim. This must be done to prevent the washer from vibrating off the stand during the spin cycle.

 The washer must not be built under a countertop.

Installation

- Use the front washer feet and the rear excess end to transport the washer from its shipping pallet to the installation site.

Do not lift the washer by the drum door!

 Ensure that the machine's feet and the floor are dry to prevent slippage during the spin cycle.

Removing the shipping struts

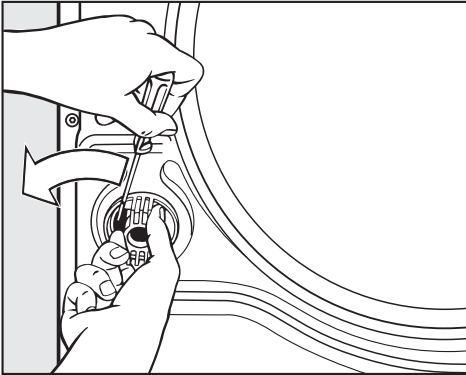

- Turn the left shipping strut counterclockwise 90°.

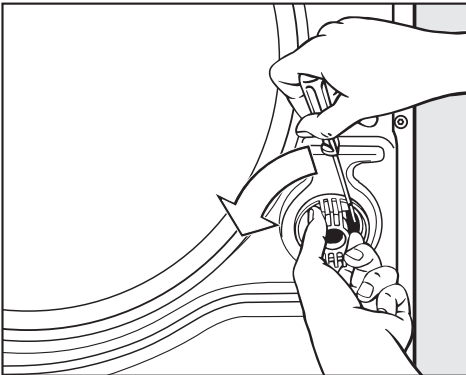

- Turn the right shipping strut counterclockwise 90°.

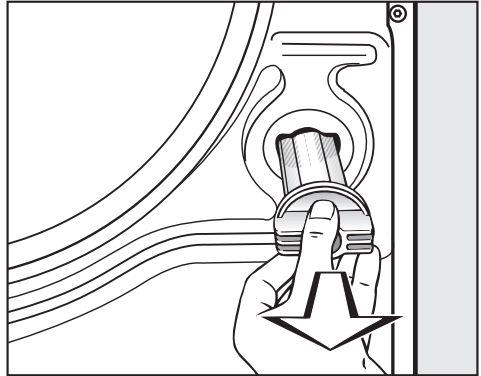

- Withdraw the two struts together with the support plate.

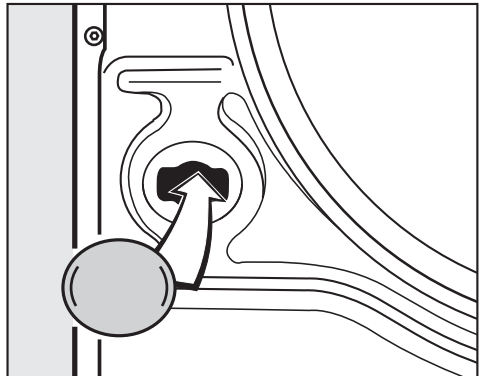

- Cover the two holes with the provided plugs.

 Movement of the washer without the shipping struts in place should be kept to a minimum. The struts must be reinstalled before the machine is moved. The shipping struts should be stored in a safe place for future use.

- Reinstall the struts by reversing the above procedure.

Installation

Leveling the washer

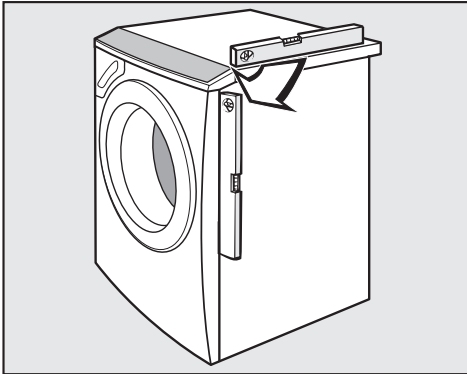

To ensure smooth operation the washer must be level.

Failure to level the machine can result in increased water and energy consumption, loud noises during the spin cycle or "walking" across the floor during use.

Adjust the four leveling feet

The washer is leveled by adjusting the four feet. The machine is delivered with all four feet completely screwed in.

- Tip the machine slightly and place a support, such as a block of wood, underneath it.

 **CAUTION:** The washer is extremely heavy. When tipping the machine be careful that it does not slip.

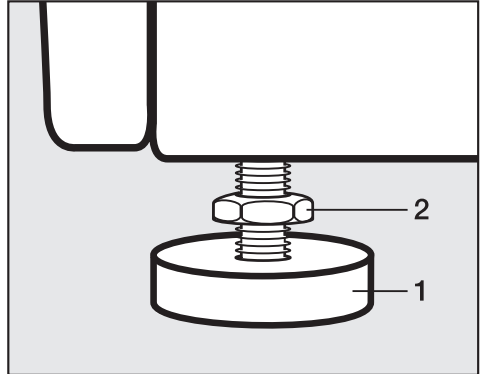

- Loosen the locking ring, **2**, with the supplied wrench.
- Unscrew each of the four feet as much as necessary by turning both the foot, **1**, and locking ring, **2**, to the left.
- Remove the support and stand the machine on its feet.
- Check that the machine stands level.
- Repeat the above procedure until the machine stands level.
- Once level, hold the foot, **1**, immobile with a wrench. At the same time, turn the locking ring, **2**, to the right using another wrench.

 All four locking rings must be tight against the bottom of the machine. In addition, check to see that the feet were not inadvertently unscrewed while tightening the rings. Operating a machine that is not level or whose feet are not tight may cause damage to both the machine and its surroundings.

The washing machine can be connected to a portable water supply. A non-return valve is not needed unless required by building code.

The washing machine has $\frac{1}{2}$ " (13 mm) pressure hoses with $\frac{3}{4}$ " (19 mm) female hose thread connections. If there is no water hookup, contact a plumber to install a connection. Make sure that the sealing ring is seated properly on the hose connector.

Replace the hose only with a genuine Miele hose, or with a hose able to withstand up to 145 psi (10 bar) pressure. The water valve connector must also be able to withstand 145 psi (10 bar).

 The bolted connection is under water pressure. Open the water supply slowly to check for leaks. Adjust the rubber seal and the bolted connection if necessary.

To protect the inlet valve, the two filters (one at the pressure hose / valve connection and one at the inlet connection to the solenoid valve) must not be removed.

Hose extension (optional accessory)

Hose extensions with a length of 8' $2\frac{7}{16}$ " to 13' $1\frac{1}{2}$ " (2.5 to 4 m) are available from Miele.

Plumbing

Water connection

- Connect the cold water intake hose (blue mark) to the cold water valve and the hot water intake hose (red mark) to the hot water valve.

If the machine is being connected only to a cold water supply, both the hot and cold water intake hoses must be attached to the cold water valve through the use of a Y adapter (available at a hardware store). Both hoses must be connected to a water source or the machine will not function properly.

Do not connect the washer to hot water only.

- Turn on the valve(s) and check for leaks. The water pressure must be within 15 -145 psi (1 -10 bar). If the water pressure is greater than 145 psi (10 bar) a pressure reducer must be installed. If the water pressure is below 15 psi (1 bar) there will not be enough water available for a complete fill.

The water intake hoses are equipped with screen filters. Do not remove these filters except for cleaning.

Tips for a hot water connection

The hot water temperature from the hot water valve must not exceed 140°F (60°C); the ideal temperature is 130°F (55°C).

If there is no water pressure at the hot water inlet, the unit will automatically switch to cold water after several minutes.

Drainage

The 5 ft (1.5 m) drain hose may be connected as follows:

1. Directly into a sink: hook the hose over the edge of the sink and secure it firmly (e.g. by tying the hose to the water faucet).
 2. To a stand pipe: place the drain hose into a 1 ½" (4 cm) stand pipe and secure it firmly.
 3. To a floor drain: The machine is equipped with an air gap / anti-siphoning system so that no minimum drain height is required.
- The machine drains using a pump with a maximum delivery height of 4 ft (1.2 m).
 - Make sure there are no kinks in the drain hose.

If necessary, the drain hose may be extended to run a maximum of 16 ft (4.9 m), as long as the 4 ft (1.2 m) height is not exceeded. Hose extensions are available from Miele.

Electrical connection

GROUNDING INSTRUCTIONS

This appliance must be grounded. In the event of a malfunction or breakdown, grounding will reduce the risk of electric shock by providing a path of least resistance for electric current. This appliance is equipped with a cord having an equipment-grounding conductor and a grounding plug. The plug must be plugged into an appropriate outlet that is properly installed and grounded in accordance with all local codes and ordinances.

WARNING – Improper connection of the equipment-grounding conductor can result in a risk of electric shock. Check with a qualified electrician or service representative if you are in doubt as to whether the appliance is properly grounded.

Do not modify the plug provided with the appliance; if it will not fit the outlet, have a proper outlet installed by a qualified electrician.

ELECTRICAL INSTRUCTIONS

This installation should be performed by an experienced and qualified technician, in accordance with local codes and regulations.

The washing machine is supplied with a 5' 3" long, 4 wire cord, ending in a NEMA 14-30 P plug, ready for connection to a 120/208-240 V, 15 A, 60 Hz, AC power supply.

The proper outlet can be purchased from an electrical supply dealer or from the Miele Technical Service Department (request a NEMA 14-30 R receptacle).

"EASY INSTALLATION KIT"

If a dedicated 4 wire, 120/208-240 V, 15 Amp line is not available for this appliance, an optional "Easy Installation Kit" will allow you to connect to a 240 V, 30 Amp line .

This dual receptacle, wall mounted connection box can **ONLY** be used for connecting a Miele 1900 series clothes washer and 1500 series clothes dryer to an existing 30 Amp (NEMA 14-30 R) outlet.

For more information on the "Easy Installation Kit," or if you have questions concerning the electrical connection, please contact:

 1-800-999-1360
techserv@mieleusa.com

 1-800-565-6435
service@miele.ca

Disposal of the packing material

The cardboard box and packing materials protect the appliance during shipping. They have been designed to be biodegradable and recyclable.

Ensure that any plastic wrappings, bags, etc. are disposed of safely and kept out of the reach of children, as they pose a danger of suffocation.

Disposal of an appliance

Old appliances may contain materials that can be recycled. Please contact your local recycling center about the possibility of recycling these materials.

Ensure that the appliance presents no danger to children while being stored for disposal. Before discarding an appliance, unplug it from the outlet, cut off its power cord and remove any doors to prevent hazards.

**Please have the model and serial number
of your appliance available before
contacting Technical Service.**



**U.S.A.
Miele, Inc.**

National Headquarters

9 Independence Way
Princeton, NJ 08540
Phone: 800-843-7231
609-419-9898
Fax: 609-419-4298
www.miele.com

**Technical Service & Support
Nationwide**

Phone: 800-999-1360
Fax: 888-586-8056
TechnicalService@mieleusa.com

**Canada
Miele Limited**

Headquarters and Showroom

161 Four Valley Drive
Vaughan, ON L4K 4V8
Phone: 800-643-5381
905-660-9936
Fax: 905-532-2290
www.miele.ca
professional@miele.ca
(commercial enquiries)

MieleCare National Service

Phone: 800-565-6435
905-532-2272
Fax: 905-532-2292
customercare@miele.ca
(general and technical enquiries)