

# Miele

TOUCHTRONIC



## Operating instructions Washer W 1213

To prevent accidents and machine damage, read these instructions **before** installation or use.



M.-Nr. 05 875 001

# Contents

---

|                                                           |    |
|-----------------------------------------------------------|----|
| <b>IMPORTANT SAFETY INSTRUCTIONS</b> . . . . .            | 4  |
| <b>Guide to the washer</b> . . . . .                      | 5  |
| Control panel . . . . .                                   | 5  |
| <b>Before using for the first time</b> . . . . .          | 6  |
| <b>Using the washer</b> . . . . .                         | 7  |
| 1. Prepare and sort the laundry . . . . .                 | 7  |
| 2. Load the laundry . . . . .                             | 8  |
| 3. Select a program . . . . .                             | 8  |
| Program guide . . . . .                                   | 9  |
| 4. Select wash options (if needed) . . . . .              | 11 |
| 5. Select the temperature and spin speed . . . . .        | 12 |
| 6. Add detergent . . . . .                                | 14 |
| <b>Detergent</b> . . . . .                                | 15 |
| Water softener . . . . .                                  | 16 |
| Fabric softener . . . . .                                 | 17 |
| Starch . . . . .                                          | 18 |
| Fabric dye . . . . .                                      | 18 |
| <b>Using the washer</b> . . . . .                         | 19 |
| 7. Select Delay Start (if needed) . . . . .               | 19 |
| 8. Start the program . . . . .                            | 19 |
| 9. Activate the program lock (if necessary) . . . . .     | 19 |
| 10. Remove the laundry . . . . .                          | 20 |
| Canceling a program . . . . .                             | 21 |
| Interrupting a program . . . . .                          | 21 |
| Making changes to the program . . . . .                   | 21 |
| Adding / removing laundry during a wash program . . . . . | 22 |
| <b>Locking the washer</b> . . . . .                       | 23 |
| Electronic program lock . . . . .                         | 23 |
| Child Safety Lock . . . . .                               | 23 |
| <b>Washer care</b> . . . . .                              | 24 |
| Cleaning the washer . . . . .                             | 24 |
| Cleaning the drum . . . . .                               | 24 |
| Cleaning the detergent drawer . . . . .                   | 25 |
| Cleaning the drain pump and lint trap . . . . .           | 26 |
| <b>Quick Guide</b> . . . . .                              | 27 |

|                                                                   |    |
|-------------------------------------------------------------------|----|
| <b>Washer care</b> . . . . .                                      | 27 |
| Cleaning the water inlet filters . . . . .                        | 28 |
| Cleaning the inlet hose filter . . . . .                          | 28 |
| Cleaning the filter in the inlet valve . . . . .                  | 28 |
| Changing the light bulb . . . . .                                 | 29 |
| <b>Frequently asked questions</b> . . . . .                       | 30 |
| A wash program cannot be started . . . . .                        | 30 |
| The program was interrupted and a fault message appears. . . . .  | 31 |
| General issues with the washer . . . . .                          | 32 |
| Poor wash results. . . . .                                        | 33 |
| The door will not open when the "Door" button is pressed. . . . . | 34 |
| Opening the drum door during a power failure . . . . .            | 35 |
| <b>Technical Service</b> . . . . .                                | 36 |
| <b>Installation instructions</b> . . . . .                        | 37 |
| <b>Help protect our environment</b> . . . . .                     | 38 |
| <b>Installation</b> . . . . .                                     | 39 |
| Front view. . . . .                                               | 39 |
| Back view. . . . .                                                | 40 |
| Installation site . . . . .                                       | 41 |
| Installation . . . . .                                            | 42 |
| Remove the shipping struts . . . . .                              | 42 |
| Installing the shipping struts . . . . .                          | 44 |
| Level the washer . . . . .                                        | 45 |
| Installation beneath a counter . . . . .                          | 46 |
| Washer stand with drawer . . . . .                                | 46 |
| Washer / Dryer Stack . . . . .                                    | 47 |
| <b>Plumbing</b> . . . . .                                         | 48 |
| Water connection . . . . .                                        | 49 |
| Drainage . . . . .                                                | 50 |
| <b>Electrical connection</b> . . . . .                            | 51 |

# IMPORTANT SAFETY INSTRUCTIONS

 **WARNING** - To reduce the risk of fire, electric shock or injury to persons while using your appliance follow basic safety precautions, including the following:

 Read all instructions before using the appliance.

 **GROUNDING INSTRUCTIONS**  
This appliance must be grounded. In the event of malfunction or breakdown, grounding will reduce the risk of electric shock by providing a path of least resistance for electric current. This appliance is equipped with a cord having an equipment-grounding conductor and a grounding plug. The plug must be plugged into an appropriate outlet that is properly installed and grounded in accordance with all local codes and ordinances.

 **WARNING** - Improper connection of the equipment-grounding conductor may result in a risk of electric shock. Check with a qualified electrician if you are in doubt as to whether the appliance is properly grounded.

 Do not modify the plug provided with the appliance - if it will not fit the outlet, have a proper outlet installed by a qualified electrician.

 Do not allow children to play on or in the appliance. Close supervision is necessary when the appliance is used near children.

 Do not wash articles that have been previously cleaned, washed, soaked or spotted with gasoline, dry-cleaning solvents or other flammable substances. These articles give off vapors that could ignite or explode. Do not add these items to the wash load.

 Under certain conditions, hydrogen gas may be produced in a hot water system that has not been used for 2 weeks or more. **HYDROGEN GAS IS EXPLOSIVE.** If the hot water system has not been used for such a period, turn on all hot water faucets and let the water flow from each for several minutes before using the washing machine. This will release any built-up hydrogen gas. Do not smoke or use an open flame during this time, the gas is flammable.

 Before the appliance is removed for service or discarded, remove the door.

 Do not reach into the appliance if the drum is moving.

 Do not install or store this appliance where it will be exposed to the weather.

 Do not tamper with the controls.

 Do not repair or replace any part of the appliance or attempt any servicing unless specifically recommended in these operating instructions.

**SAVE THESE INSTRUCTIONS**

## Control panel

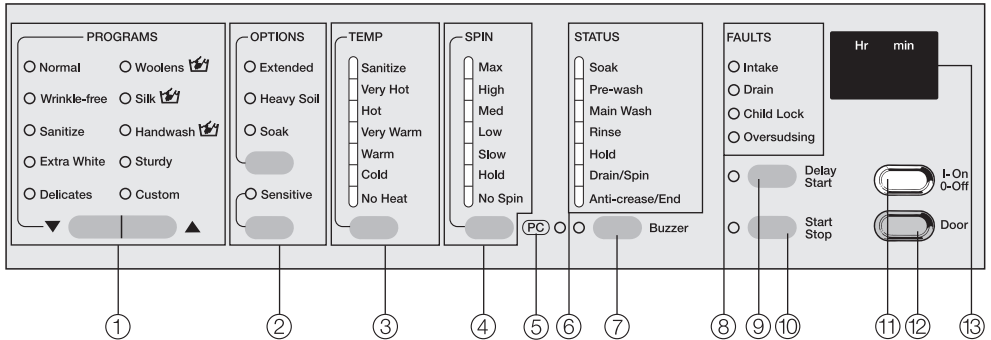

**① Program selection buttons ▼▲**

For selecting a program.

**② Wash options**

Special features to enhance a wash program.

**③ Temperature button**

For selecting the desired wash temperature.

**④ Spin speed button**

For selecting the desired spin speed.

**⑤ PC Indicator**

Allows a service technician to check and update the wash programs.

**⑥ Program status display**

Shows the current cycle of the wash program.

**⑦ "Buzzer" button**

**⑧ Fault indicators**

**⑨ "Delay Start" button**

For delaying the start of a program.

**⑩ "Start / Stop" button**

Begins the wash program or interrupts a program.

**⑪ "On / Off" button**

Turns the machine on and off.

**⑫ "Door" button**

Opens the drum door.

**⑬ Display (hr / min)**

Shows the delayed start time and the countdown to the end of the program.

## Before using for the first time

---

The appliance must be correctly installed and connected before the first use. Please see the "Installation instructions".

For safety reasons, it is not possible to run a spin cycle before the first use. A program must be run **without laundry and detergent** to flush out any residual water from the factory testing process, as well as to activate the spin cycle. Using detergent can cause sudsing and ball valve activation, resulting in the need to use the maximum amount of detergent in the future.

- Turn on the water valve.
- Press the "On / Off" button.
- Select the "Extra White" program with the program buttons.
- Press the "Start / Stop **G**" button.

Once the program ends, the washer can be used for laundry.

## 1. Prepare and sort the laundry

- Empty all pockets.

⚠ Foreign objects left in pockets (e.g. nails, coins, paper clips, etc.) can cause damage to clothes and the machine.

- Sort the laundry.

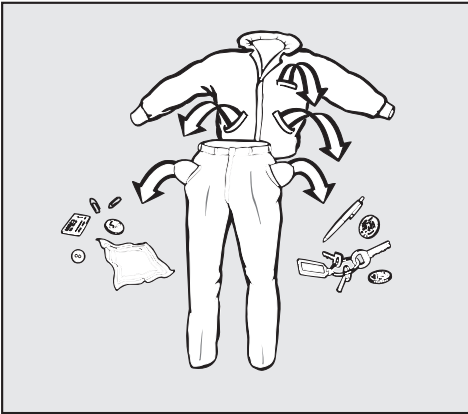

Only wash items in the machine that are labeled machine washable by the manufacturer. Most garments have a fabric care label in the collar or side seam. Sort the laundry by care label and color.

- Pretreat stains.

Tough stains (e.g. blood, egg, coffee, tea, etc.) or badly soiled areas (e.g. collars and cuffs) should be penetrated with a stain remover or a paste made from powdered detergent and warm water.

⚠ Do not use chemical solvents in the machine.

## General tips

- Dark fabrics often bleed the first few times they are washed. They should be washed separately several times before being included in a mixed load.
- Remove any lead weights or strips from curtains before washing.
- Loose underwires should be removed or sewn in place before washing.
- Woolens and knitted garments should be turned inside out.
- Close zippers and hooks and eyes before washing.
- Comforter covers and pillowcases should be fastened in order to prevent small items from rolling inside of them.

Do **not** machine wash items if it is not recommended on the fabric care label.

# Using the washer

## 2. Load the laundry

- Turn on the washer using the "On / Off" button.
- Open the drum door using the "Door" button.
- Load the laundry into the drum. For best results, wash mixed loads of small and large items. This will improve washing effectiveness and help distribute the load evenly.

**Note:** Overloading the washer will cause poor wash results and wrinkling.

- Close the drum door.

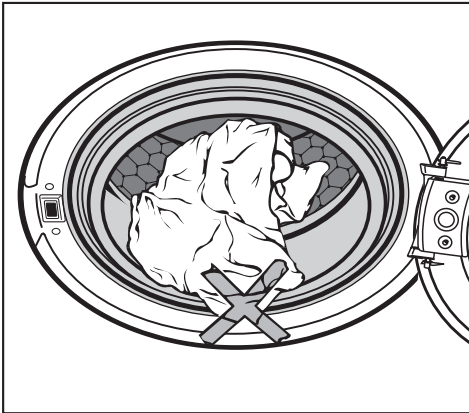

To prevent damage to the door seal and clothing, make sure that there is nothing caught between the drum door and the seal.





















## 3. Select a program





























- Press the "PROGRAMS" button ▼ or ▲ until the desired program indicator lights.



## Program guide

| Temperatures        | Fabric care symbol                                                                                                                                                      | Spin speed | Laundry                                                                                                                                                                       |
|---------------------|-------------------------------------------------------------------------------------------------------------------------------------------------------------------------|------------|-------------------------------------------------------------------------------------------------------------------------------------------------------------------------------|
| <b>Normal</b>       | Options: Extended, Heavy Soil, Soak, Sensitive                                                                                                                          |            |                                                                                                                                                                               |
| Hot                 |                                                                                        | <b>Max</b> | For a rapid wash of colorfast items and mixed loads made from cottons and linen, e.g. jeans, t-shirts, underwear, socks.                                                      |
| Very Warm           |                                                                                        | High       |                                                                                                                                                                               |
| <b>Warm</b>         |                                                                                        |            |                                                                                                                                                                               |
| Cold                |                                                                                        |            |                                                                                                                                                                               |
| No Heat             |       |            |                                                                                                                                                                               |
| <b>Wrinkle-free</b> | Options: Extended, Heavy Soil, Soak, Sensitive                                                                                                                          |            |                                                                                                                                                                               |
| Hot                 |                                                                                        | <b>Med</b> | For cotton blends, polyester blends and synthetics, e.g. acrylic, nylon, ramie. Fabric softener can be dispensed in the final rinse of these programs to reduce static cling. |
| Very Warm           |                                                                                        |            |                                                                                                                                                                               |
| Warm                |                                                                                        |            |                                                                                                                                                                               |
| <b>Cold</b>         |                                                                                        |            |                                                                                                                                                                               |
| No Heat             |       |            |                                                                                                                                                                               |
| <b>Sanitize</b>     | Options: Extended, Heavy Soil, Soak, Sensitive                                                                                                                          |            |                                                                                                                                                                               |
| <b>Sanitize</b>     |                                                                                        | <b>Max</b> | For white items with special hygienic demands, e.g. baby clothing, underwear, towels.                                                                                         |
| Very Hot            |                                                                                        | High       |                                                                                                                                                                               |
| <b>Extra White</b>  | Options: Extended, Heavy Soil, Soak                                                                                                                                     |            |                                                                                                                                                                               |
| Sanitize            |                                                                                      | <b>Max</b> | For white items without special hygienic demands.                                                                                                                             |
| Very Hot            |                                                                                      | High       |                                                                                                                                                                               |
| <b>Hot</b>          |                                                                                      |            |                                                                                                                                                                               |
| <b>Delicates</b>    | Options: Extended, Heavy Soil, Soak                                                                                                                                     |            |                                                                                                                                                                               |
| Warm                |                                                                                      | <b>Low</b> | For delicate machine washable clothing, e.g. satin, hosiery, lingerie, lace or crocheted (non-wool) items.                                                                    |
| <b>Cold</b>         |                                                                                      |            |                                                                                                                                                                               |
| No Heat             |   |            |                                                                                                                                                                               |

# Using the washer

| Temperatures                                                                                      | Fabric care symbol                                                                  | Spin speed                                                                          | Laundry                                                                        |
|---------------------------------------------------------------------------------------------------|-------------------------------------------------------------------------------------|-------------------------------------------------------------------------------------|--------------------------------------------------------------------------------|
| <b>Woolens</b>   |                                                                                     |                                                                                     |                                                                                |
| Options: Sensitive                                                                                |                                                                                     |                                                                                     |                                                                                |
| Warm                                                                                              |    |                                                                                     | For hand and machine washable wool and wool blends.                            |
| <b>Cold</b>                                                                                       |    | <b>Med</b>                                                                          |                                                                                |
| No Heat                                                                                           |    |    |                                                                                |
| <b>Silk</b>      |                                                                                     |                                                                                     |                                                                                |
| Options: Sensitive                                                                                |                                                                                     |                                                                                     |                                                                                |
| <b>Cold</b>                                                                                       |    |                                                                                     | For hand and machine washable silks and other non-wool hand washable garments. |
| No Heat                                                                                           |    |    |                                                                                |
| <b>Handwash</b>  |                                                                                     |                                                                                     |                                                                                |
| Options: Extended, Heavy soil, Sensitive                                                          |                                                                                     |                                                                                     |                                                                                |
| Warm                                                                                              |    |                                                                                     | For hand washable items with no wool or silk content.                          |
| <b>Cold</b>                                                                                       |    |                                                                                     |                                                                                |
| No Heat                                                                                           |    |    |                                                                                |
| <b>Sturdy</b>                                                                                     |                                                                                     |                                                                                     |                                                                                |
| Options: None                                                                                     |                                                                                     |                                                                                     |                                                                                |
| <b>Warm</b>                                                                                       |    |                                                                                     | For a mixed load of colorfast or perma press items, or for cotton blends.      |
| Cold                                                                                              |    | Low                                                                                 |                                                                                |
| No Heat                                                                                           |    |    |                                                                                |
| <b>Custom</b>                                                                                     |                                                                                     |                                                                                     |                                                                                |
| Options: Extended, Heavy Soil, Soak, Sensitive                                                    |                                                                                     |                                                                                     |                                                                                |
| Sanitize                                                                                          |   |                                                                                     | All options can be selected individually for colorfast or white items.         |
| Very Hot                                                                                          |  | High                                                                                |                                                                                |
| Hot                                                                                               |  | Med                                                                                 |                                                                                |
| Very Warm                                                                                         |  | Low                                                                                 |                                                                                |
| Warm                                                                                              |  | Slow                                                                                |                                                                                |
| <b>Cold</b>                                                                                       |  | Hold                                                                                |                                                                                |
| No Heat                                                                                           |  |  |                                                                                |
|                                                                                                   |                                                                                     | No Spin                                                                             |                                                                                |

## 4. Select wash options (if needed)

The upper button selects the following "OPTIONS":

- Extended
- Extended and Heavy Soil
- Extended and Soak
- Heavy Soil
- Soak
- No selection

The lower button selects the "Sensitive" option.

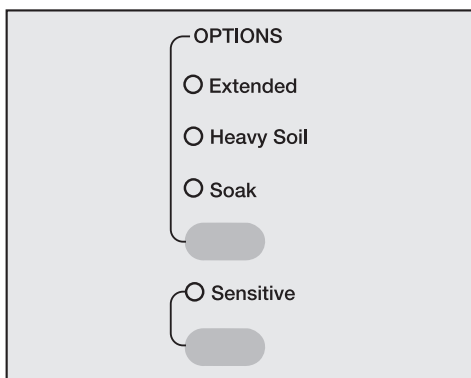

- Select the desired "OPTIONS". Press the upper button until the indicator of the desired wash option lights.

See the "Program Guide" to determine which options can be selected in each program.

If the wash option chosen is not compatible with the program, the indicator light will go out when the button is released.

### Extended

For laundry with normal to heavy soiling or stains.

The main wash cycle time for the wash program will be extended.

### Heavy Soil

For heavily soiled laundry where a pretreatment is necessary to remove surface soiling.

### Soak

For heavy soiling and stubborn stains (e.g. blood, grease, chocolate) that require soaking before the main wash.

The preset soak time is 2 hours.

### Sensitive

An additional final rinse that will wash away detergent residue and scents.

### Buzzer

A buzzer signals the end of the wash program, or after "No Spin".

The buzzer will sound until the washer is turned off. Once activated, the buzzer is active in all programs unless turned off.

The warning sound (indicating a fault has occurred) will activate independent of whether the buzzer is turned on or off.



# Using the washer

## 5. Select the temperature and spin speed

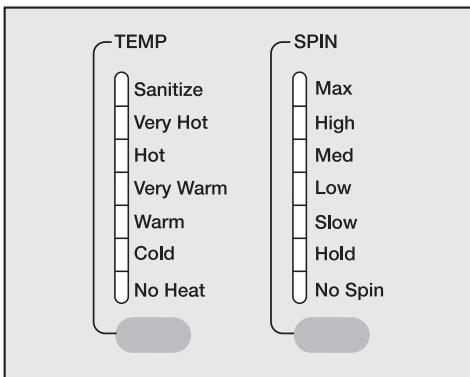
The default temperature and spin speed will automatically be selected for each program. However, you can adjust the temperature and spin speed within the parameters of the selected wash program.



- Press the "TEMP" and "SPIN" buttons until the indicator of the desired setting lights.

| Program                                                                                           | Spin speed    |
|---------------------------------------------------------------------------------------------------|---------------|
| <b>Normal</b>                                                                                     | High          |
| <b>Wrinkle Free</b>                                                                               | Med           |
| <b>Sanitize</b>                                                                                   | High          |
| <b>Extra White</b>                                                                                | High          |
| <b>Delicates</b>                                                                                  | Low           |
| <b>Woolens</b>   | High          |
| <b>Silk</b>      | Slow          |
| <b>Handwash</b>  | Med           |
| <b>Sturdy</b>                                                                                     | Med           |
| <b>Custom</b>                                                                                     | Max - No Spin |

The laundry is spun after the main wash and between the rinse cycles. Reducing the final spin speed will also reduce the rinse spin speeds. If in the programs "Sturdy" and "Custom" a spin speed lower than "Med" is selected, an extra rinse cycle is added to remove any detergent left in the laundry.

## Special spin options

### Hold

(only for the "Custom" program)

- Select "Hold".

The laundry is not spun and remains soaking in water. This will prevent wrinkles if the laundry is not removed immediately at the end of the wash program.

### To start the final spin

- Select the desired spin speed.
- Press the "Start / Stop"  button.

### To finish the program

- Press the "Door" button.

The water will be drained away.

- Use the "Door" button to open the door.

## No spin

- Select "No spin".

The laundry is not spun after the final rinse, but the water is drained away. After the drain cycle, the washer goes immediately into the Anti-Crease cycle. Spinning between these rinses is also omitted in this setting. If "No Spin" is selected in the programs "Sturdy" and "Custom", an extra rinse cycle is added.

# Using the washer

## 6. Add detergent

For optimum wash results, it is important to use the correct amount of detergent.

### Too little detergent may cause:

- Ineffective cleaning of laundry; fabrics may become gray and stiff over time.
- Grease stains on the laundry.
- Hard water deposits on the heating element.

### Too much detergent may cause:

- Oversudsing with minimal drum movement; poor wash, rinse and spin results.
- Higher water consumption through an automatic, additional rinse cycle.
- Higher environmental burden.

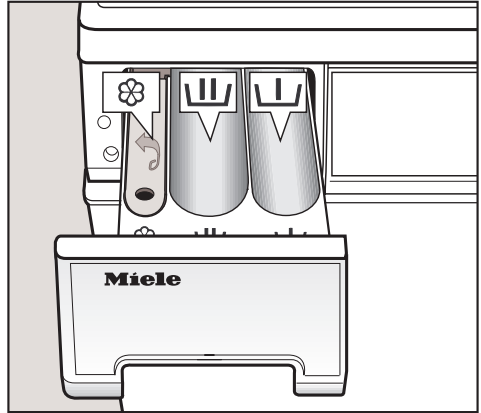

- Pull out the detergent dispenser drawer and add detergent to the compartments.

 = Detergent for the main wash

 = Only add detergent ( $\frac{1}{4}$  of the total recommended amount of detergent) to this compartment if the "Heavy Soil" wash option is selected.

 = Fabric softener or liquid starch.



- Close the detergent dispenser drawer.

 Do not use detergents containing chemical solvents.

Use only high efficiency, low sudsing laundry detergent formulated for front loading washing machines.

For wool and wool blend fabrics, use a detergent specially formulated for woolsens.

Follow instructions on the detergent packaging to ensure the correct usage and dosage amount. Adjust the amount of detergent if the load is smaller or more or less soiled than normal.

Add detergent to the main wash compartment  at the beginning of each wash program. Only add detergent ( $\frac{1}{4}$  of the total recommended amount) to compartment  if the "Heavy Soil" option was selected.

## Liquid detergent insert

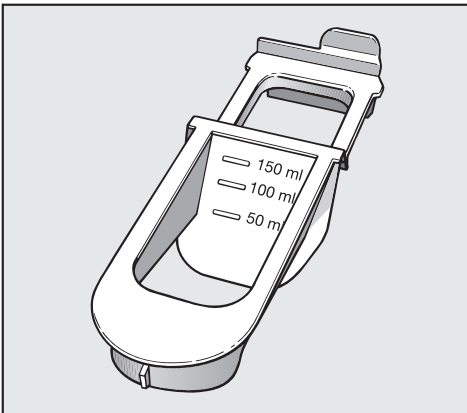

An insert is supplied in the drum of the washer.

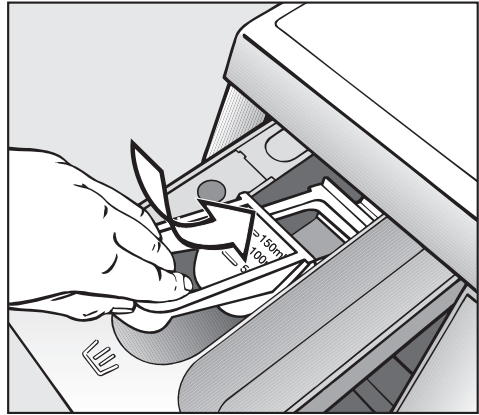

- If you are using liquid detergent, use the liquid detergent insert in the main wash compartment .

The insert helps to measure the correct amount of detergent. It also prevents the detergent for the main wash from being used during the Pre-wash when the "Heavy Soil" option is used.

Remove the insert from the compartment  when powder detergent is used.

 Do not use chlorine bleach!

# Detergent

---

**The amount of detergent used depends on the level of soiling:**

## Light soiling

No soiling or stains are visible.

## Normal soiling

Some visible soiling or a few light stains.

## Heavy soiling

Very visible soiling or stains.

The size of the load and the water hardness level in your area have an impact on the amount of detergent necessary to obtain optimum wash results. If you do not know the water hardness level in your area, contact your local water authority.

## Water hardness

| Hardness level | Water quality     | Water hardness in mmol/l | German hardness in °d |
|----------------|-------------------|--------------------------|-----------------------|
| I              | soft              | 0 - 1.3                  | 0 - 7                 |
| II             | moderate          | 1.3 - 2.5                | 7 - 14                |
| III            | hard to very hard | over 2.5                 | over 14               |

## Water softener

If the water hardness level is between II and III, you can soften the water to reduce detergent consumption.

The detergent packaging should indicate the correct amount to use in your machine. Add the detergent, then add the water softener. You can then use the recommended amount of detergent for water hardness level I.



## Fabric softener

Fabric softener added to the wash program will make fabrics feel softer and will reduce static cling in the dryer.

- Open the lid of the fabric softener compartment ☼.

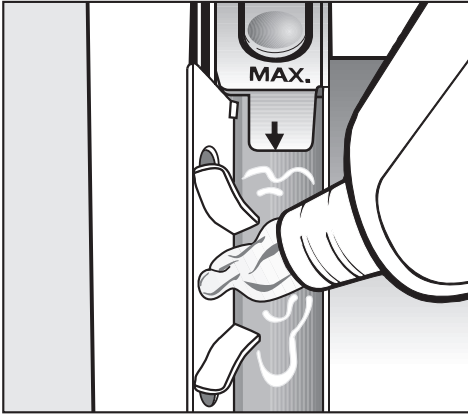

- Pour liquid fabric softener into the compartment according to the manufacturer's instructions. **Do not exceed the maximum fill level** marked inside the compartment, as the excess will prematurely activate the siphon and be wasted.
- Close the compartment lid and push in the dispenser drawer.

The fabric softener will automatically be dispensed during the final rinse cycle. A small amount of water will remain in the compartment at the end of the program.

Never mix fabric softener and starch together in the fabric softener compartment ☼. This will clog the dispenser.

# Detergent

---

## Starch

Mild liquid starch is a synthetic starch wash used to give fabrics some stiffness. Starching can be included in any wash program as part of the final rinse.

- Open the fabric softener compartment .

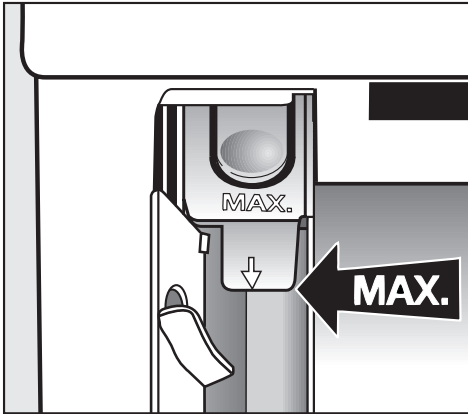

- Add the recommended amount of starch to the compartment.  
**Do not exceed the maximum fill level.**
- Close the compartment lid and push in the dispenser drawer.
- The starch will be dispensed during the final rinse.

At the end of the program, a small amount of water will remain in the fabric softener compartment.

## Fabric dye

Do not use fabric dyes in this washer!

## 7. Select Delay Start (if needed)

If you wish, the start of the wash program can be delayed to have a load completed at a later time. Delay start allows you to delay the start of a program for 30 minutes to a maximum of 24 hours.

- Press the "Delay Start" button. The delay start time will be extended with each press of the button.
- For less than a 10 hour delay, the delay time extends in 30 minute increments.
- For more than a 10 hour delay, the delay time extends in 1 hour increments.

### Canceling Delay Start

- Press the "Delay Start" button until 24 appears in the display, press once more and the action will be canceled.

## 8. Start the program

- Press the flashing "Start / Stop **G**" button to begin the program.

The display will show the maximum program run time. It will count down in minutes. For the first 10 minutes, the washer calculates the water absorbency of the laundry, possibly lengthening or shortening the overall program time.

## 9. Activate the program lock (if necessary)

- Press the "Start / Stop **G**" button until the "Child Lock" indicator lights.

See "Locking the washer" for further details.

# Using the washer

## 10. Remove the laundry

The "STATUS" indicator "Anti-Crease / End" will be displayed at the end of the program.

- Use the "Door" button to open the drum door.

Do not attempt to remove laundry from the washer if the drum is turning. You may seriously injure yourself. If the drum turns with the door open, contact Miele's Technical Service Department.

- Remove the laundry.

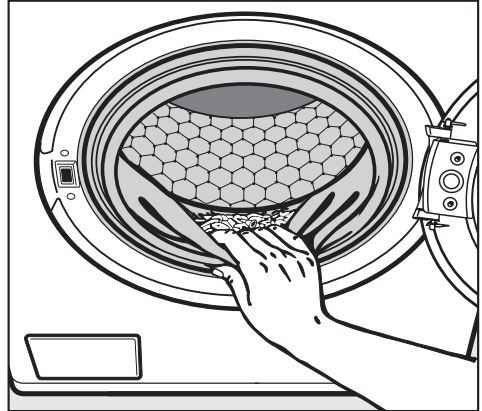

- Check the folds of the door seal for any small articles which may have been trapped.

Check the drum for any missed pieces of laundry. Items inadvertently left in the washer may be damaged (e.g. shrink or discolor) during the next wash cycle.

- Turn the washer off using the "On / Off" button.
- Close the drum door.

## Canceling a program

You can cancel a wash program any time after a program starts.

- Press the "Start / Stop **G**" button.

The washer drains the wash water away and the program is canceled.

## To add or remove laundry

- Press the "Door" button.

## To select another program

- Turn off the washer using the "On / Off" button.
- Turn on the washer using the "On / Off" button.

## Interrupting a program

- Turn off the washer using the "On / Off" button.

## To continue the program

- Turn on the washer using the "On / Off" button.

## Making changes to the program

- A program change is not possible once a program has started. To select a different program, the started program must be canceled.
- The buzzer can be turned on or off.
- A spin speed can be selected until the final spin starts.

No changes can be made if the program lock is activated.

# Using the washer

---

## Adding / removing laundry during a wash program

You can interrupt the following programs to add or remove a piece of laundry:

- Normal
- Wrinkle-free
- Sturdy
- Use the "Door" button to open the door.
- Add or remove the piece of laundry.
- Close the drum door.

The program will continue automatically.

### Note

Once the program has started, the washer cannot make adjustments for the load size.

The time remaining will automatically adjust.

## The drum door cannot be opened if:

- the water temperature is greater than **130°F (55°C)**.
- the water level is too high.
- the final spin has started.
- the program lock is activated.

If you press the "Door" button during any of these conditions, the "Child Lock" indicator will light.

## Electronic program lock

### Washer in use

The program lock prevents the washer from being opened or the program, temperature or spin speed from being changed during a wash program.

### To activate the program lock

- Once the wash program has started, hold the "Start / Stop **G**" button until the "Child Lock" indicator illuminates.

The program lock is now activated. The washer can no longer accept program changes.

At the end of the program, the program lock is automatically unlocked.

### To cancel the program lock

- Hold the "Start / Stop **G**" button until the "Child Lock" indicator goes out.

## Child Safety Lock

### Washer not in use

The Child Safety Lock can be activated to prevent a child from operating or climbing inside the washer.

When the Child Safety Lock is activated, the drum door cannot be opened and a program cannot be started.

### To activate the Child Safety Lock

- The washer must be turned off.
- The drum door must be closed.

Steps **1.** to **4.** must be carried out within 5 secs or the washer will not recognize the activated Child Safety Lock.

**1.** Press and hold the "Sensitive" and "TEMP" buttons until step **4.**

**2.** Turn on the washer using the "On / Off" button.

A dot shows in the display.

**3.** Press the "Extended / Heavy Soil / Soak" button **three times.**

**4.** Release the "Sensitive" and "TEMP" buttons.

The "Child lock" indicator flashes.

### To deactivate the Child Safety Lock

- Repeat steps **1.** through **4.**

The "Child Lock" indicator will go out.

## Washer care

---

 Before cleaning the appliance, disconnect the power supply by unplugging the unit or manually tripping the circuit breaker.

### Cleaning the washer

- Clean the exterior of the washer with a mild solution of non-abrasive detergent or soap and water. Wipe dry with a soft cloth.
- Clean the drum with a stainless steel cleaner specially formulated for use in a washing machine. This type of cleaner is available from Miele.

### Cleaning the drum

Germs can develop when using wash programs with a low temperature (below Hot) over several wash cycles. This can lead to odors in the drum.

- **Once a month** run a program with no laundry using a "Sanitize" or "Very hot" temperature and/or bleach.

If the correct amount of detergent is dispensed, the machine should not need to be descaled.

If the washer needs to be descaled, use a descaling agent with corrosion protection. These special descaling agents can be purchased from Miele. Use as directed on the packaging.



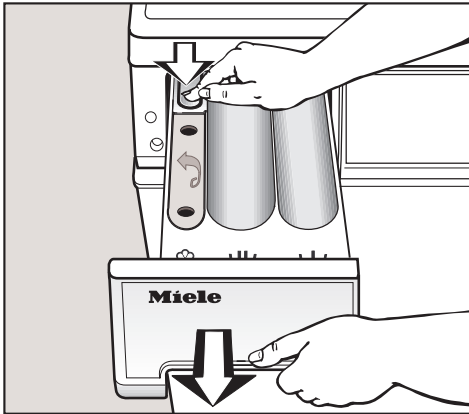

## Cleaning the detergent drawer

Detergent residue should be cleaned out regularly.

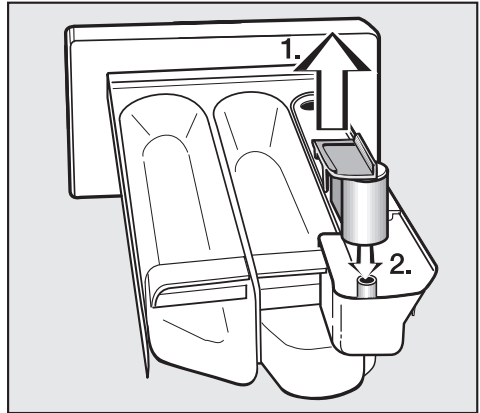

- Pull the detergent drawer out as far as it will go. Press down on the red release lever and pull the drawer out of the machine.
- Clean the detergent drawer with warm water.
- Clean the siphon tube.



1. Remove the siphon tube from the fabric softener compartment  and rinse under warm water. Clean the pipe on which the siphon tube is attached.
2. Replace the siphon tube.

 Do not use chemical solvents, abrasive cleaners, glass or all purpose cleaners. These can damage plastic surfaces and other parts.

## Washer care

### Cleaning the drain pump and lint trap

Occasionally, small objects (buttons, coins, etc.) may become trapped in the lint trap. If the machine does not drain completely, the lint trap should be checked to ensure that it is free of foreign objects.

- Turn off the appliance with the "On / Off" button.

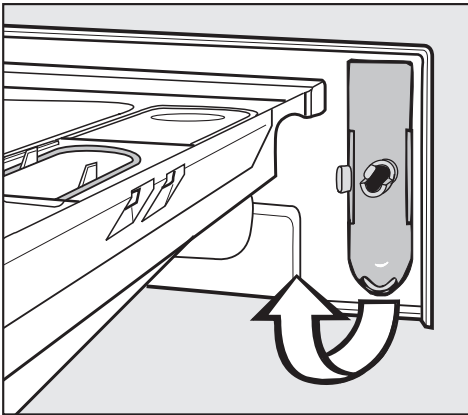

- To clean the lint trap, remove the tool from behind the detergent dispenser drawer.

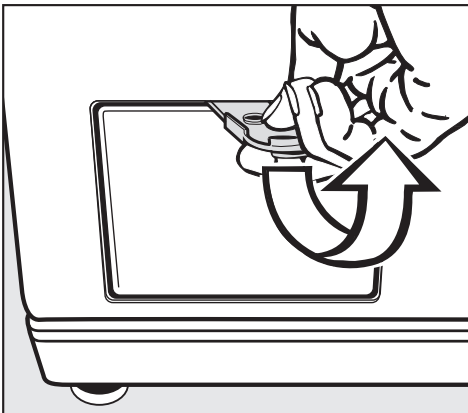

- Open the access panel.

If the main drain hose is clogged, water will be retained in the machine (**a maximum amount of 6.5 gal [25 l]**).

**⚠ Caution:** If laundry has been washed at a high temperature, the water draining out of the machine will still be hot! Allow it to cool before proceeding.



- Turn the lint trap lid counterclockwise. Do not remove it. About 2 quarts of water will drain out of the hose.

If additional water remains in the machine, tighten the lint trap lid and empty the container. Repeat this procedure as often as necessary.

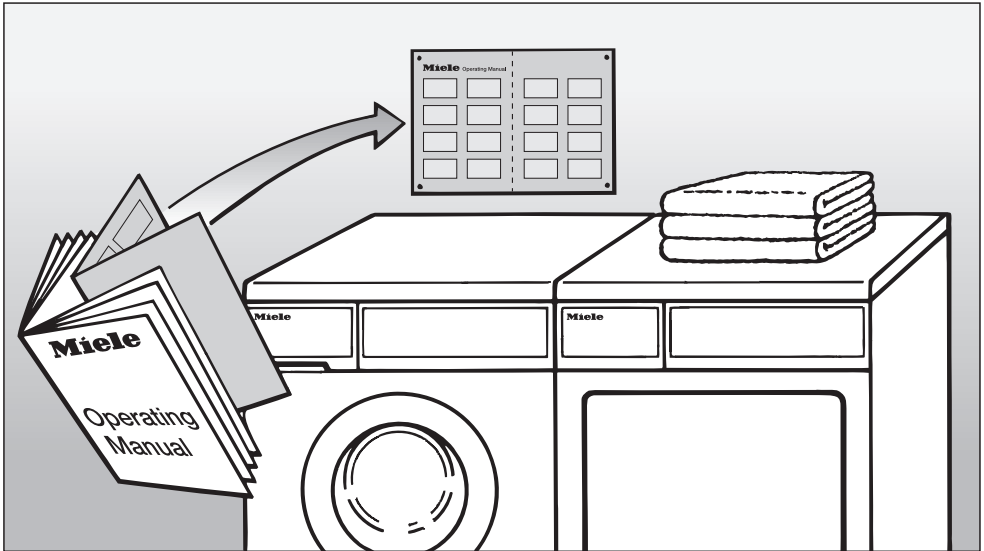

## Quick Guide

Remove this guide for easy  
reference

Please read all  
instructions, especially  
the "Important Safety Instructions",  
**before** using the washer.

# Quick Guide

## 1. Sort the laundry.

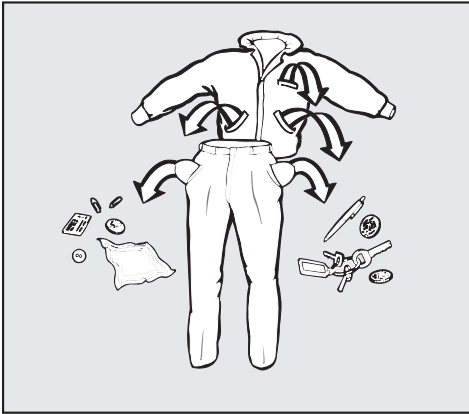

- Empty all pockets.
- Sort the laundry by fabric and color.
- Pretreat stains.

## 2. Load the laundry



- Turn on the washer using the "On / Off" button.



- Open the drum door by using the "Door" button.
- Load the laundry.
- Close the drum door.

Make sure clothes will not be caught by the door.

## 3. Select a program



- Select the desired program.

Refer to the "Program guide" to determine which program is most suitable for the load being washed.

## 4. Select wash options (if needed)

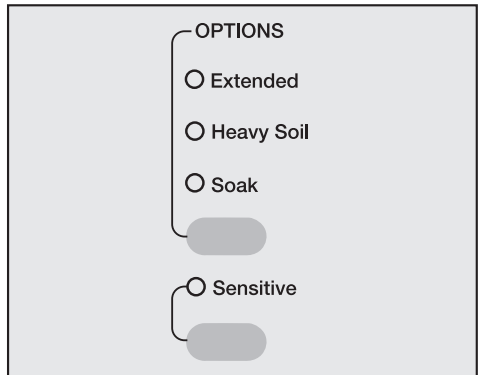

- Press the upper button until the indicator of the desired wash option lights.
- Press the lower button to select the "Sensitive" wash option.

## 5. Select the temperature and spin speed

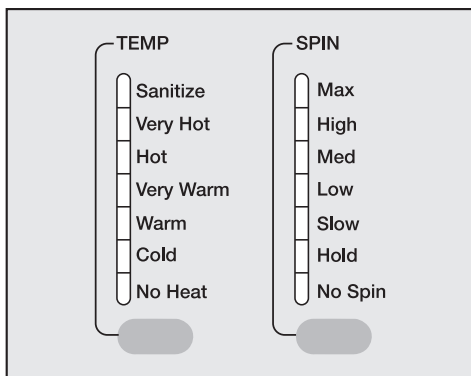

- Press the "TEMP" and "SPIN" buttons until the indicator of the desired value lights.

## 6. Add detergent

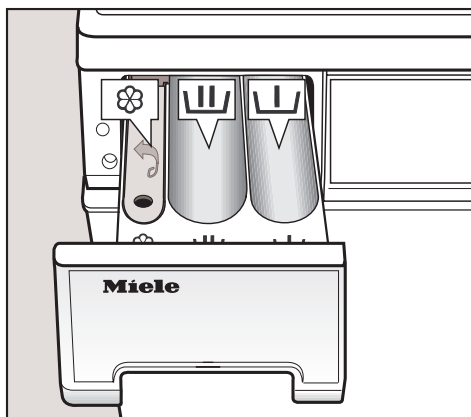

- Place the recommended amount of detergent into the main wash compartment . If "Heavy Soil" is selected, add  $\frac{1}{4}$  of the total amount of detergent to the compartment. Place fabric softener or liquid starch in compartment .

## 7. Select Delay Start (if needed)



- Press the "Delay Start" button.

## 8. Start the program



- Press the "Start / Stop button.

## 9. Activate the program lock (if necessary)

- Hold the "Start / Stop button until the "Child Lock" indicator lights up.

## 10. Unload the laundry



- Open the drum door using the "Door" button.
- Remove the laundry.



- Turn off the washer using the "On / Off" button.
- Close the drum door.

# Quick Guide

## Program guide

| Normal                                                               |
|----------------------------------------------------------------------|
| <b>Options:</b><br>Extended, Heavy Soil, Soak, Sensitive             |
| <b>Temperatures:</b><br>Hot  , Very Warm  , Warm  , Cold  , No Heat  |
| <b>Spin speeds:</b> Max, High                                        |
| <b>Items:</b><br>For a quick load of colorfast items.                |
| Wrinkle-free                                                         |
| <b>Options:</b><br>Extended, Heavy Soil, Soak, Sensitive             |
| <b>Temperatures:</b><br>Hot  , Very Warm  , Warm  , Cold  , No Heat  |
| <b>Spin speed:</b> Med                                               |
| <b>Items:</b><br>For clothing that tends to wrinkle easily.          |
| Sanitize                                                             |
| <b>Options:</b><br>Extended, Heavy Soil, Soak, Sensitive             |
| <b>Temperatures:</b><br>Sanitize  , Very Hot                         |
| <b>Spin speeds:</b> Max, High                                        |
| <b>Items:</b><br>For a load of whites with special hygienic demands. |
| Extra White                                                          |
| <b>Options:</b> Extended, Heavy Soil, Soak                           |
| <b>Temperatures:</b><br>Sanitize  , Very Hot  , Hot                  |
| <b>Spin speeds:</b> Max, High                                        |
| <b>Items:</b><br>For a quick load of white items.                    |
| Delicates                                                            |
| <b>Options:</b> Extended, Heavy Soil, Soak                           |
| <b>Temperatures:</b><br>Warm  , Cold  , No Heat                      |
| <b>Spin speed:</b> Low                                               |
| <b>Items:</b><br>For delicate clothing that wrinkles easily.         |

| Woolens                                                                                     |
|---------------------------------------------------------------------------------------------|
| <b>Options:</b> Sensitive                                                                   |
| <b>Temperatures:</b><br>Warm  , Cold  , No Heat                                             |
| <b>Spin speed:</b> High, Med                                                                |
| <b>Items:</b><br>For hand washable and machine washable wool.                               |
| Silk                                                                                        |
| <b>Options:</b> Sensitive                                                                   |
| <b>Temperatures:</b> Cold  , No Heat                                                        |
| <b>Spin speed:</b> Slow                                                                     |
| <b>Items:</b><br>For silk items.                                                            |
| Handwash                                                                                    |
| <b>Options:</b> Extended, Heavy soil, Sensitive                                             |
| <b>Temperatures:</b><br>Warm  , Cold  , No Heat                                             |
| <b>Spin speed:</b> Med                                                                      |
| <b>Items:</b><br>For hand washable items with no wool or silk content.                      |
| Sturdy                                                                                      |
| <b>Options:</b> None                                                                        |
| <b>Temperatures:</b><br>Warm  , Cold  , No Heat                                             |
| <b>Spin speeds:</b><br>Med, Low                                                             |
| <b>Items:</b><br>For a quick, mixed load of colorfast items.                                |
| Custom                                                                                      |
| <b>Options:</b><br>Extended, Heavy Soil, Soak, Sensitive                                    |
| <b>Temperatures:</b><br>Sanitize  , Very Hot  , Hot  , Very Warm  , Warm  , Cold  , No Heat |
| <b>Spin speeds:</b><br>Max, High, Med, Low, Slow, Hold, No Spin                             |
| <b>Items:</b><br>All options can be selected individually for colorfast or white items.     |

Once the flow of water stops:

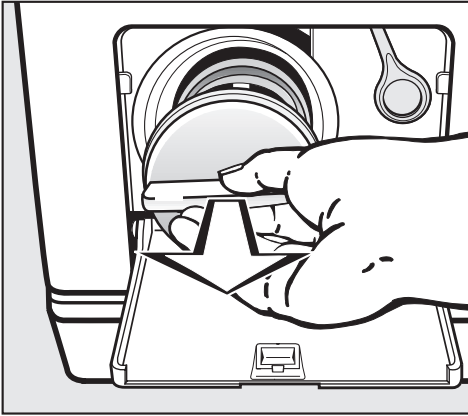

- Remove the lint trap lid.
- Remove any foreign objects or lint from the filter.

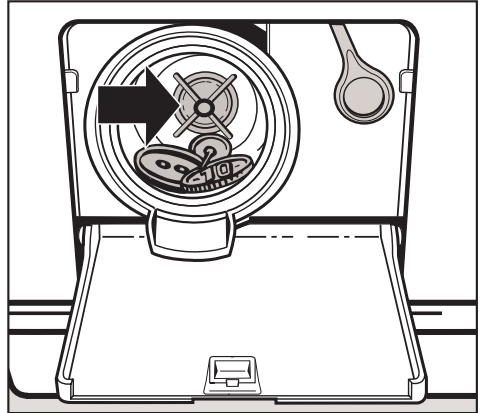

- Check that the impeller (in the back of the chamber) rotates freely by spinning it with your hand.
- Return the lint trap and tighten into place.

 If the lint trap lid is not tightened securely, water will leak out when the machine is used.

# Washer care

## Cleaning the water inlet filters

The washer has two water inlet filters to protect each inlet valve. These filters should be checked every 6 months and cleaned, if necessary. (This may need to be performed more frequently with some water supplies).

## Cleaning the inlet hose filter

- Turn off the water valve.

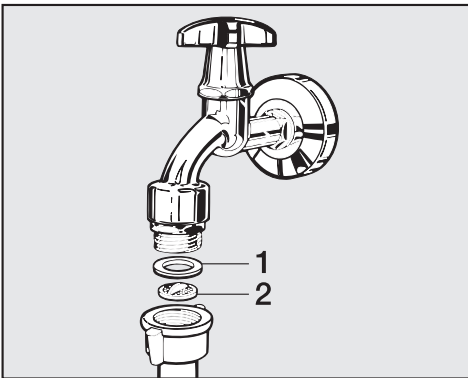

- Unscrew the inlet hose from the valve by turning the connector counterclockwise using a wrench if necessary.
- Remove the rubber seal, **1**, from the connector.
- Using needle nose pliers, grasp the plastic filter, **2**, and pull it out of the hose connector.
- Clean the filter under running water and carefully remove any large particles. Replace the filter, seal and reconnect the hose.
- Slowly turn on the valve and check for leaks.

⚠ Inspect the hose regularly. The hose must be in good condition to withstand high water pressure. The hose should be replaced if there are cracks in the surface, or if it has been otherwise damaged or cut.

## Cleaning the filter in the inlet valve

- Using a wrench, carefully loosen and remove the plastic hose connector on the inlet valve.
- Using needle nose pliers, remove the plastic filter (see illustration). Rinse under water and return parts.

Both filters **must** be put back in place after cleaning.



### Changing the light bulb

A burnt out light bulb will not affect the performance of the washer.

- Remove the tool from behind the detergent dispenser drawer.
- Turn the washer on and open the door.
- Disconnect the power supply to the work area by unplugging the unit, tripping the circuit breaker or removing the fuse.

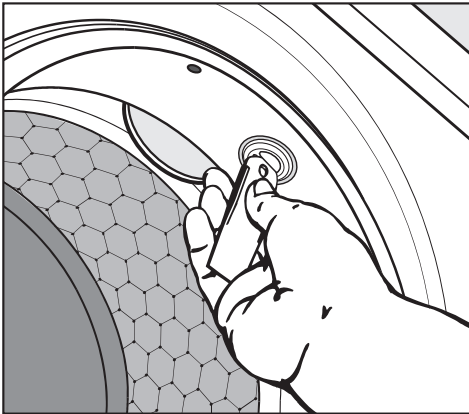

- Insert the tool into the slit of the light bulb, then turn counterclockwise until resistance is felt.
- Pull out the drum lighting.

A replacement bulb can be obtained by contacting Miele.

- Insert the new light bulb into the socket. Shift it back and forth until the bulb falls into place, then turn clockwise with the tool.

A fault will appear and the washer will not function if the light bulb is not inserted correctly. If this occurs reinsert the light bulb.

## Frequently asked questions

---

 Repairs to electrical appliances must only be carried out by a qualified and trained person in accordance with local and national safety regulations. Repairs and other work by unqualified persons could be dangerous. The manufacturer cannot be held responsible for unauthorized work.

The following section will help you avoid placing a service call by identifying issues you may encounter while operating the machine:

| <b>A wash program cannot be started</b>                                                                                                                    |                                            |                                                                                                  |
|------------------------------------------------------------------------------------------------------------------------------------------------------------|--------------------------------------------|--------------------------------------------------------------------------------------------------|
| <b>Issue</b>                                                                                                                                               | <b>Possible cause</b>                      | <b>Solution</b>                                                                                  |
| <b>The display stays blank and no indicator illuminates.</b>                                                                                               | The washer has no power.                   | Check to determine if:<br>– the washer is plugged in.<br>– the circuit breaker has been tripped. |
| <b>The "Child Lock" indicator flashes.</b>                                                                                                                 | The electronic lock function is activated. | Deactivate the lock function.                                                                    |
| <b>The program will not start after pressing the "Start/Stop  button.</b> | The door is not properly closed.           | Close the drum door.                                                                             |

## Frequently asked questions

### The program was interrupted and a fault message appears.

| Issue                                                                                                     | Possible cause                  | Solution*                                                                                                                                |
|-----------------------------------------------------------------------------------------------------------|---------------------------------|------------------------------------------------------------------------------------------------------------------------------------------|
| <b>The buzzer sounds, and the "Drain" indicator flashes. "- - -". appears in the display.</b>             | The drain is blocked.           | Clean the drain pump and lint trap. See "Washer care - Cleaning the drain pump and lint trap".                                           |
|                                                                                                           | The drain hose is too high.     | The maximum drain pump height should not exceed 4 ft. (1.2 m).                                                                           |
| <b>The buzzer sounds, and the "Intake" indicator flashes. "- - -". appears in the display.</b>            | The water intake is blocked.    | Check to determine if: <ul style="list-style-type: none"> <li>– the water valve is open.</li> <li>– the inlet hose is kinked.</li> </ul> |
|                                                                                                           | The inlet hose filter is dirty. | Clean the filter under running water and carefully remove any large particles.                                                           |
| <b>The buzzer sounds, and the "Intake" and "Drain" indicators flash. "- - -". appears in the display.</b> | There is a fault.               | Call the Miele Service Department.                                                                                                       |
| <b>The buzzer sounds and the "Soak" and "Rinse" indicators flash. "- - -". appears in the display.</b>    | There is a fault.               | Restart the program.<br>If the fault message appears again, call Miele's Technical Service Department.                                   |

\* To turn off the fault message: Turn off the washer using the "On / Off" button.

## Frequently asked questions

| <b>General issues with the washer</b>                                                                                                                                                                     |                                                                                            |                                                                                                                                                                                                |
|-----------------------------------------------------------------------------------------------------------------------------------------------------------------------------------------------------------|--------------------------------------------------------------------------------------------|------------------------------------------------------------------------------------------------------------------------------------------------------------------------------------------------|
| <b>Issue</b>                                                                                                                                                                                              | <b>Possible cause</b>                                                                      | <b>Solution</b>                                                                                                                                                                                |
| <b>The "Oversudsing" indicator lights.</b>                                                                                                                                                                | The machine has over sudsed.                                                               | Use less detergent in the next wash program.                                                                                                                                                   |
| <b>The "Main wash" indicator flashes.</b>                                                                                                                                                                 | There is a fault.                                                                          | Restart the program. If the fault message appears again, call Miele's Technical Service Department.                                                                                            |
| <b>The washer shakes during the spin cycle.</b>                                                                                                                                                           | The washer's four feet are not resting evenly on the floor.                                | Level the machine (see Installation Instructions).                                                                                                                                             |
| <b>There are unusual sounds coming from the drain pump.</b>                                                                                                                                               | There is no fault. Lapping sounds at the beginning and end of the pump process are normal. |                                                                                                                                                                                                |
| <b>A large amount of detergent residue remains in the dispenser drawer.</b>                                                                                                                               | The water pressure is too low.                                                             | <ul style="list-style-type: none"> <li>– Clean the water intake hose filter under running water and carefully remove any large particles.</li> <li>– Select the "Sensitive" button.</li> </ul> |
| <b>The fabric softener is not completely dispensed, or too much water remains in the fabric softener compartment .</b> | The siphon tube is incorrectly positioned or clogged.                                      | Clean the siphon tube (see "Cleaning and care-Cleaning the detergent dispenser drawer").                                                                                                       |

## Frequently asked questions

| <b>Poor wash results</b>                                   |                                                                                                                                        |                                                                                                                                                                                                                                    |
|------------------------------------------------------------|----------------------------------------------------------------------------------------------------------------------------------------|------------------------------------------------------------------------------------------------------------------------------------------------------------------------------------------------------------------------------------|
| <b>Issue</b>                                               | <b>Possible cause</b>                                                                                                                  | <b>Solution</b>                                                                                                                                                                                                                    |
| <b>The wash does not come clean with liquid detergent.</b> | Liquid detergents do not contain bleaching agents. Fruit, coffee and tea stains cannot be effectively removed.                         | <ul style="list-style-type: none"><li>– Use powdered bleach.</li><li>– Do not put liquid detergent and stain remover together in the same wash compartment.</li></ul>                                                              |
| <b>Laundry has a gray, sticky residue.</b>                 | An inadequate amount of detergent was used to dissolve greasy deposits in heavily soiled laundry (e.g. grease, oils or lotion stains). | <ul style="list-style-type: none"><li>– Add more detergent to the laundry or use a liquid detergent.</li><li>– Run a "Normal - Hot" program with liquid detergent to clean the washer before using it for laundry again.</li></ul> |
| <b>There is white detergent residue on dark laundry.</b>   | The detergent was not completely dissolved because of hard water.                                                                      | <ul style="list-style-type: none"><li>– After drying, remove white residue with a clothing brush.</li><li>– Add a water softener to the detergent for future loads.</li></ul>                                                      |

## Frequently asked questions

| <b>The door will not open when the "Door" button is pressed.</b>                                                    |                                                                                                          |
|---------------------------------------------------------------------------------------------------------------------|----------------------------------------------------------------------------------------------------------|
| <b>Possible cause</b>                                                                                               | <b>Solution</b>                                                                                          |
| <b>The washer has no power.</b>                                                                                     | Insert the plug into the outlet.                                                                         |
| <b>The washer is not turned on.</b>                                                                                 | Turn on the washer using the "On / Off" button.                                                          |
| <b>The program lock is activated.</b>                                                                               | Deactivate the program lock as described in "Locking the washer - Electronic program lock".              |
| <b>The Child Lock function is activated.</b>                                                                        | Deactivate the Child Safety Lock as described in "Locking the washer - Child Safety Lock".               |
| <b>Power failure</b>                                                                                                | To open the drum door, see "Frequently asked questions - Opening the drum door during a power failure."  |
| <b>The door was not properly closed.</b>                                                                            | Push on the drum door and at the same time, press the "Door" button.                                     |
| <b>There is still water in the drum and the washer cannot drain it away.</b>                                        | Clean the drain filter and the drain pump as described in "Cleaning and Care - Cleaning the drain pump". |
| As a safeguard against scalding, the drum door cannot be opened if the wash water temperature is over 130°F (55°C). |                                                                                                          |

### Opening the drum door during a power failure

- Open the detergent dispenser drawer.

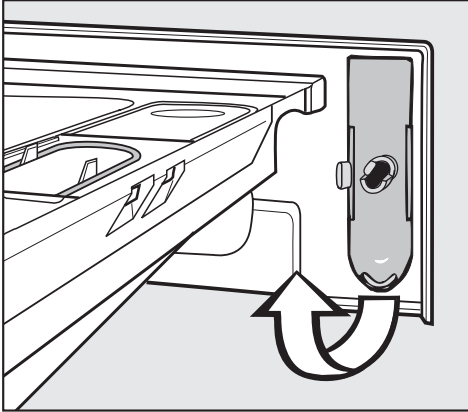

- Remove the tool.

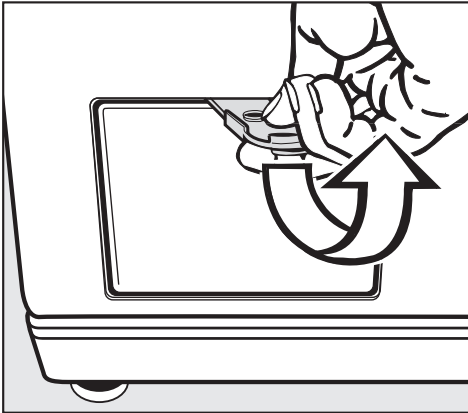

- Open the lint trap door.
- Drain the water from the washer as described in "Washer care / Cleaning the drain pump and lint trap".

 Make sure the machine is turned off and the drum has stopped turning. A moving drum is dangerous.

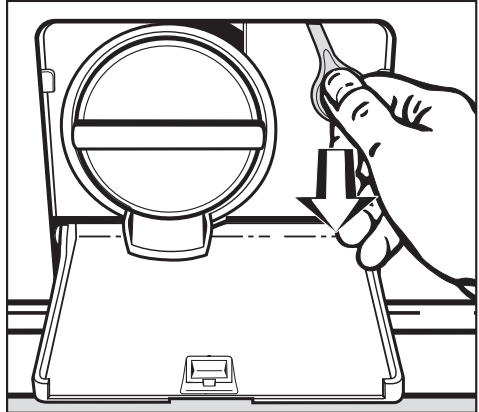

- To open the door, pull down on the ring in the upper right corner of the access area.

# Technical Service

---

## Repairs

In the event of a fault which you cannot fix yourself, please contact the service number on the back of this manual.

When contacting the Technical Service Department, please quote the model and serial number of your appliance. Both can be found on the data plate visible above the front glass on the inside of the door.

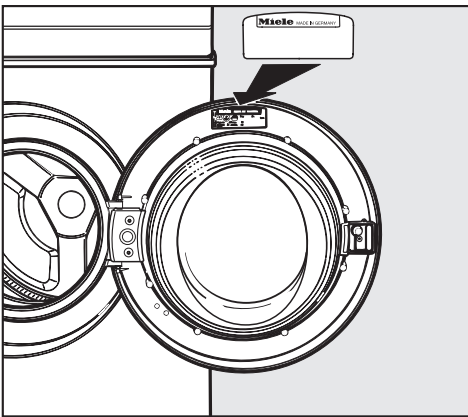

## PC Update

The indicator marked PC allows a technician to make use of new technology. When, for example, new programs are developed or new fabrics are introduced, a service technician will be able to modify existing program cycles accordingly.

Miele will provide information when such possibilities become available.

## Optional accessories

Optional accessories are available through your Miele dealer or Miele.

## MieleCare

(USA only)

**MieleCare**, our Extended Service Contract program; gives you the assurance of knowing that your appliance investment is covered by 5 years of worry free ownership.

**MieleCare** is the only Extended Service Contract in the industry that guarantees repairs by a Miele Authorized Service Provider using genuine Miele parts. Only genuine Miele parts installed by factory trained professionals can guarantee the safety, reliability and longevity of your Miele appliance.

Please note that unless expressly approved in writing by the Miele Service department, Extended Service Contracts offered by other providers for Miele products will not be recognized by Miele. Our goal is to prevent unauthorized (and untrained) service personnel from working on your Miele products, possibly doing further damage to them, you and/or your home.

To learn more about **MieleCare** Extended Service Contracts, please contact your appliance dealer or visit us online at:

[www.store.miele.com](http://www.store.miele.com)



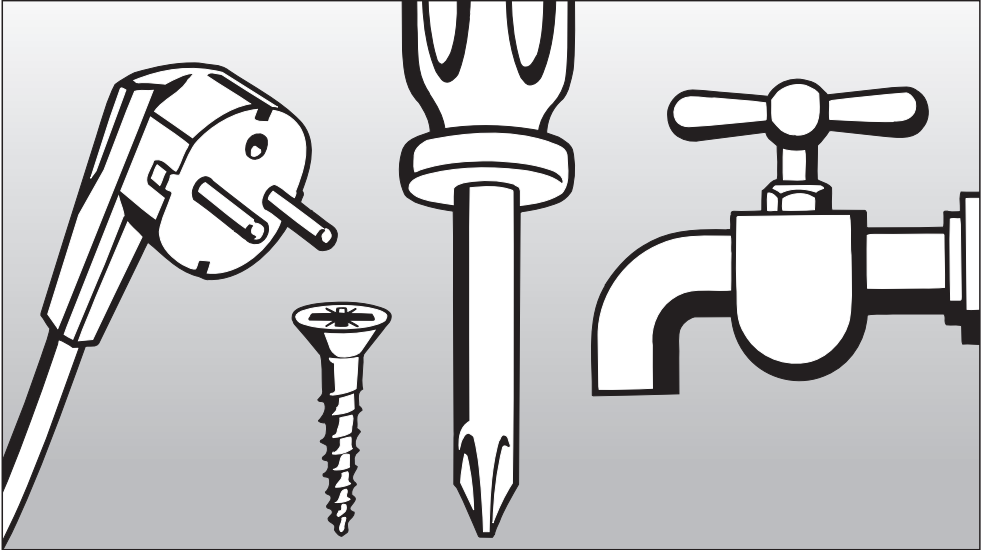

## Installation Instructions

To prevent accidents  
and machine damage  
read these instructions

**before**  
installation or use.

# Help protect our environment

---

## **Disposal of the packing material**

The cardboard box and packing materials protect the appliance during shipping. They have been designed to be biodegradable and recyclable.

Ensure that any plastic wrappings, bags, etc. are disposed of safely and kept out of the reach of children, as they pose a danger of suffocation.

## **Disposal of an appliance**

Old appliances may contain materials that can be recycled. Please contact your local recycling authority about the possibility of recycling these materials.

Ensure that the appliance presents no danger to children while being stored for disposal. Before discarding an appliance, unplug it from the outlet, cut off its power cord and remove any doors to prevent hazards.

## Front view

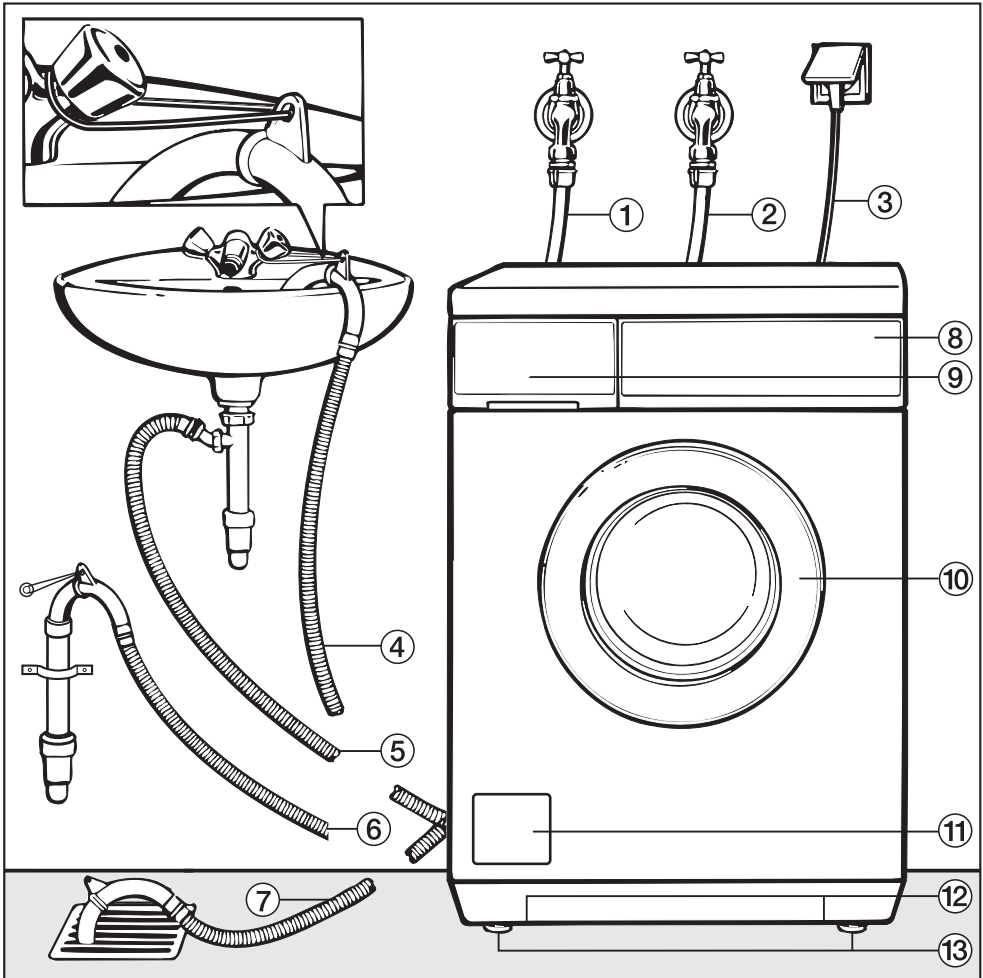

- ① Hot water intake hose
- ② Cold water intake hose
- ③ Power cord
- ④ - ⑦ Drain hose (drain options shown i.e adjustable and removable elbows).
- ⑧ Control panel
- ⑨ Detergent dispenser drawer
- ⑩ Drum door
- ⑪ Access panel to lint trap and drain pump
- ⑫ Recessed grip
- ⑬ Four height-adjustable feet

# Installation

## Back view

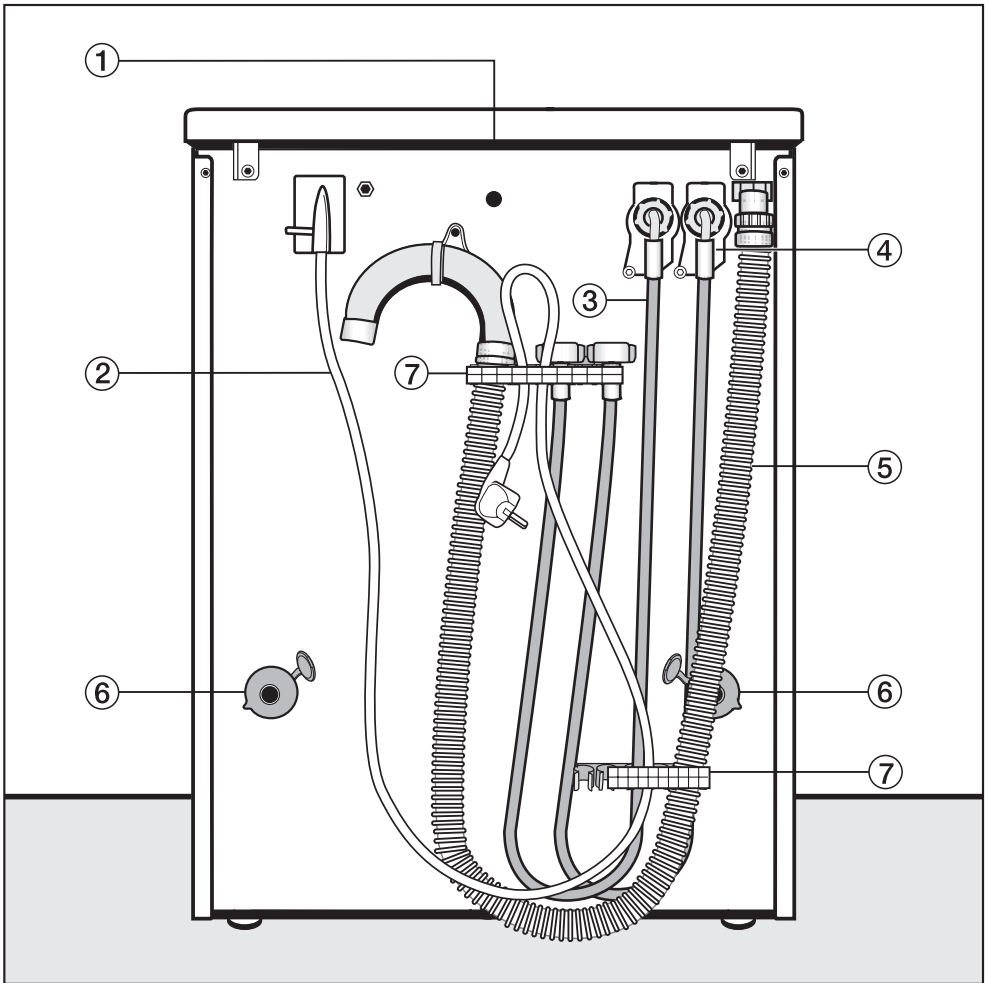

① Lid excess end with transport grips

② Power cord

③ Cold water intake hose

④ Hot water intake hose

⑤ Drain hose

⑥ Shipping struts with rotary protection

⑦ Mounting for:

– Water intake hose

– Drain hose

– Power cord

– Shipping struts

## Installation site

A concrete or reinforced floor is the most suitable surface for the washer. These types of floors are less prone to vibration during the spin cycle.

### Note:

- The machine must be leveled and securely positioned.
- To avoid vibration while spinning, the machine should not be installed on soft floor coverings.

If the installation must be performed on a wooden floor:

- Install the unit on a 2 ft. x 2 ft. x  $1\frac{3}{16}$ " (61 x 61 x 3 cm) plywood base. Ideally, the base should be large enough to span several joists, and should be anchored to the joists, not just the floor boards.

It is best to install the washer in the corner of a room, where the stability of the floor is at its greatest.

 If the machine is installed on a raised platform, it must be secured with retaining clips. These clips are available from your dealer or Miele. If installed on a masonry or concrete base, the base should have a  $\frac{1}{2}$ " to  $\frac{3}{4}$ " (12 - 20 mm) high rim. This is required to prevent the washer from vibrating off the stand during the spin cycle.

# Installation

## Installation

- Lift the machine from its shipping pallet and move it to the installation site.

**Do not lift the washer by the drum door!**

 Ensure that the machine's feet and the floor are dry to prevent slippage during the spin cycle.

## Remove the shipping struts

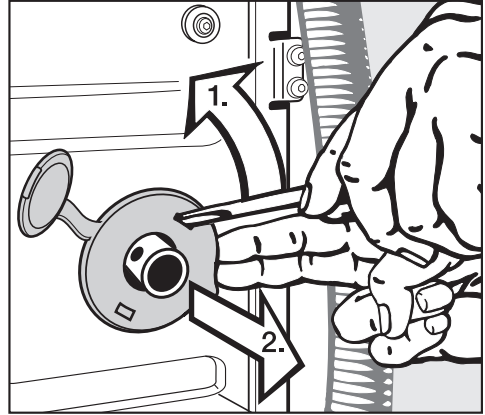

- Remove the left and right rotary protectors.
  - Unhook, **1**, the protectors with a screw driver and remove, **2**.

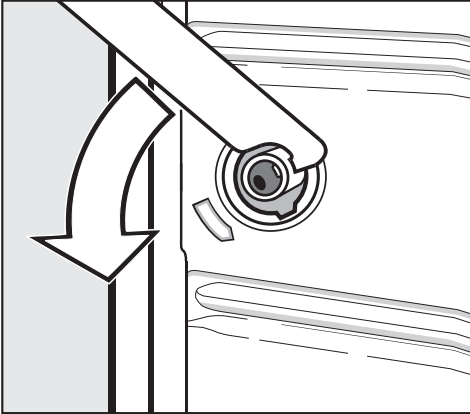

- Turn the left shipping strut counterclockwise 90° with the enclosed combination wrench.

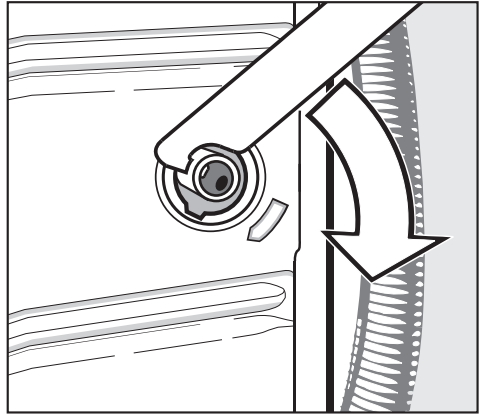

- Turn the right shipping strut clockwise 90° with the enclosed combination wrench.

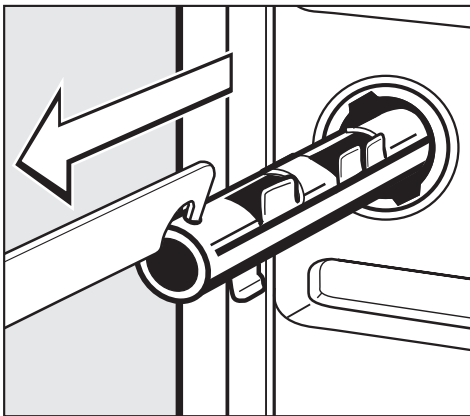

- Pull out the shipping strut.

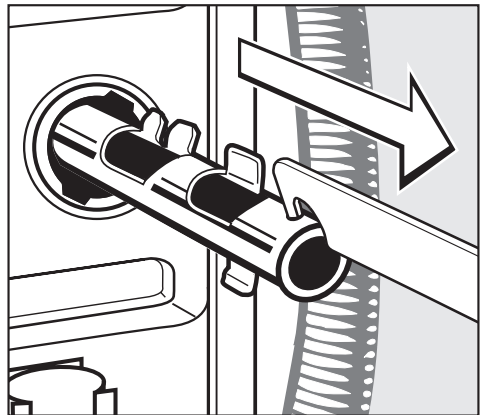

- Pull out the shipping strut.

# Installation

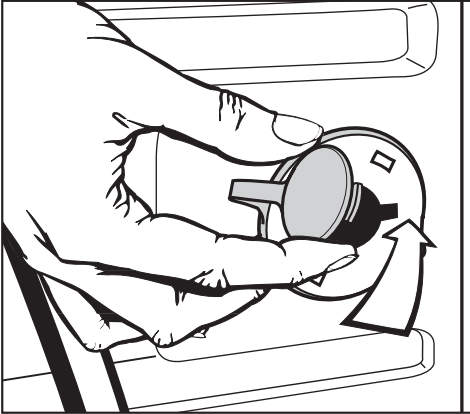

## Installing the shipping struts

Reinstall the struts by reversing the "Remove the shipping struts" procedure.

- Close the holes with the rotary protectors, making sure to close the caps.

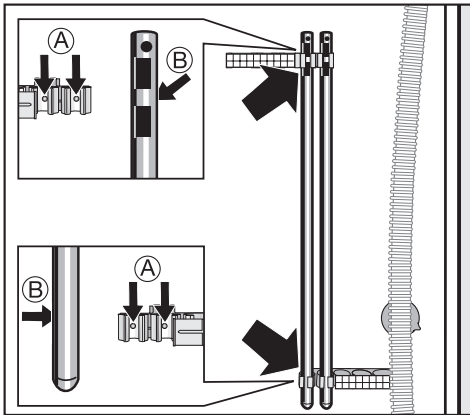

- Fasten the shipping struts to the rear of the washer. Take care to insert the drill holes correctly, **B**, into the clamps, **A**.

 Do not move the washer without the shipping struts in place.



## Level the washer

To ensure smooth operation, the washer must be level.

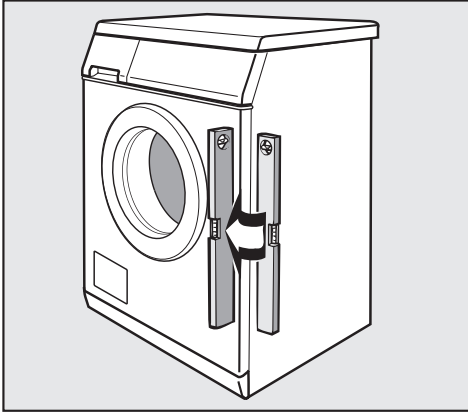

Failure to level the machine can result in increased water and energy consumption, loud noises during the spin cycle or "walking" across the floor during use.

## Adjust the four leveling feet

The washer is leveled by adjusting the four feet:

- Tip the machine slightly and place a support, such as a block of wood, underneath it.
- Unscrew each of the four feet as much as necessary by turning both the foot, **1**, as well as the locking ring, **2**, to the left using a screwdriver.

 **CAUTION:** The washer is extremely heavy. When tipping the machine be careful that it does not slip.

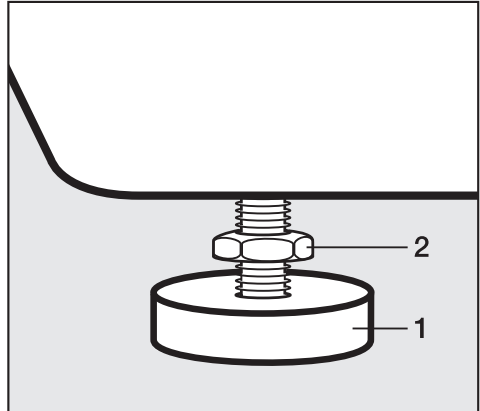

- Turn the locking ring, **2**, counterclockwise with the enclosed combination wrench. Unscrew each of the four feet as much as necessary by turning both the foot, **1**, as well as the locking ring, **2**, to the left.
- Check that the machine stands level.
- Once level, hold the foot, **1**, steady with a wrench. Turn the locking ring, **2**, with the combination wrench towards the machine.

 All four locking rings must be tight against the bottom of the machine. In addition, check to see that the feet were not inadvertently unscrewed while tightening the rings. Running a machine that is not level or whose feet are not tight may cause damage to both the machine and its surrounding area.

# Installation

---

## Installation beneath a counter

If a countertop is placed over the washer, at least a  $\frac{1}{4}$ " gap must be left between the top of the machine and bottom of the countertop; nothing should be within  $\frac{1}{2}$ " of any side of the washing machine.

- When the machine lid needs to be removed to reduce the height of the machine, a **countertop kit**\* is necessary. The cover plate in the countertop kit replaces the machine lid and ensures electrical safety.
- A filler frame\* is recommended at a countertop height of  $35 \frac{7}{16}$ " to  $35 \frac{13}{16}$ " (90 - 91 cm).
- Water intake, drain and electrical connections should be installed near the machine and be easily accessible.

An installation manual is supplied with the countertop kit.

(\* available from your Miele dealer or Miele.)

## Washer stand with drawer

A washer stand is available to raise the machine for convenience. It has a drawer to store cleaning essentials.

The stand can be purchased as an optional accessory.

## Washer / Dryer Stack

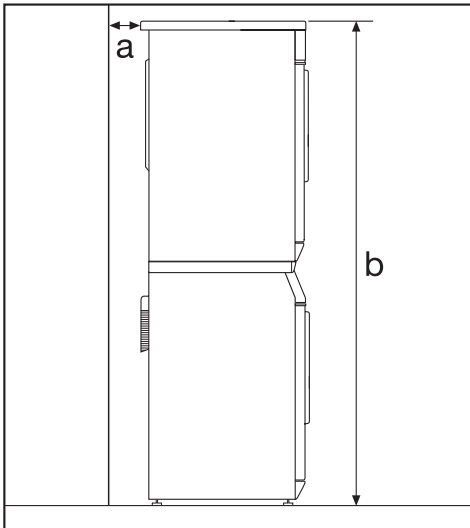

The Miele washing machine can be installed as part of a washer-dryer stack in combination with a Miele tumble dryer. An appropriate "stacking kit\*" is required.

(\* available from your Miele dealer or Miele.)

### Note:

- a** Safety distance to the wall:  
minimum  $1\frac{3}{16}$ " (2 cm)
- b** Height:  
Stacking kit with pull out shelf  
 $66\frac{15}{16}$ " (170 cm)

## Reinstallation of the machine lid

When reinstalling the machine lid, check the fit of the cover at the rear bracket to ensure safe transport.

# Plumbing

---

The washing machine can be connected to a portable water supply. A non-return valve is not needed unless required by building code.

The washing machine has  $\frac{1}{2}$ " (13 mm) pressure hoses with  $\frac{3}{4}$ " (19 mm) female hose thread connections. If there is no water hookup, contact a plumber to install a connection. Make sure that the sealing ring is seated properly on the hose connector.

Replace the hose only with a genuine Miele hose, or with a hose able to withstand up to 145 psi (10 bar) pressure. The water valve connector must also be able to withstand 145 psi (10 bar).

 The bolted connection is under water pressure. Open the water supply slowly to check for leaks. Adjust the rubber seal and the bolted connection if necessary.

To protect the inlet valve, the two filters (one at the pressure hose / valve connection and one at the inlet connection to the solenoid valve) must not be removed.

## **Hose extension (optional accessory)**

Hose extensions with a length of 8'  $2 \frac{7}{16}$ " to 13'  $1 \frac{1}{2}$ " (2.5 to 4 m) are available from your Miele dealer or Miele.

## Water connection

- Connect the cold water intake hose (blue mark) to the cold water valve and the hot water intake hose (red mark) to the hot water valve.

If the machine is being connected **only** to a cold water supply, both the hot and cold water intake hoses must be attached to the cold water valve through the use of a Y adapter (available at a hardware store). Both hoses **must** be connected to a water source or the machine will not function properly.

### **Do not connect the washer to hot water only.**

- Turn on the valve(s) and check for leaks. The water pressure must be within 15 -145 psi (1 -10 bar). If the water pressure is greater than 145 psi (10 bar) a pressure reducer must be installed. If the water pressure is below 15 psi (1 bar) there will not be enough water available for a complete fill.

The water intake hoses are equipped with screen filters. Do not remove these filters except for cleaning.

## Tips for a hot water connection

The hot water temperature from the hot water valve must not exceed 140°F (60°C); the ideal temperature is 130°F (55°C).

If there is no water pressure at the hot water inlet, the unit will automatically switch to cold water after several minutes.

# Plumbing

---

## Drainage

The 5 foot (1.5 m) drain hose may be connected as follows:

- 1. Directly into a sink:** hook the hose over the edge of the sink and secure it firmly (e.g. by tying the hose to the water faucet).
- 2. To a stand pipe:** place the drain hose into a 1 ½" (4 cm) stand pipe and secure it firmly.
- 3. To a floor drain:** The machine is equipped with an air gap / anti-siphoning system so that no minimum drain height is required.

- The machine drains using a pump with a maximum delivery height of 4 feet (1.2 m).
- Make sure there are no kinks in the drain hose.

If desired, the drain hose may be extended to run a maximum of 16 feet (4.9 m), as long as the 4 foot (1.2 m) height is not exceeded. Hose extensions are available from your dealer or Miele.

## GROUNDING INSTRUCTIONS

This appliance must be grounded. In the event of a malfunction or breakdown, grounding will reduce the risk of electric shock by providing a path of least resistance for electric current. This appliance is equipped with a cord having an equipment-grounding conductor and a grounding plug. The plug must be plugged into an appropriate outlet that is properly installed and grounded in accordance with all local codes and ordinances.

**WARNING** – Improper connection of the equipment-grounding conductor can result in a risk of electric shock. Check with a qualified electrician or service representative if you are in doubt as to whether the appliance is properly grounded.

Do not modify the plug provided with the appliance; if it will not fit the outlet, have a proper outlet installed by a qualified electrician.

## ELECTRICAL INSTRUCTIONS

This installation should be performed by an experienced and qualified technician, in accordance with local codes and regulations.

The washing machine is supplied with a 5' 3" (1.6 m) long, 4 wire cord, ending in a NEMA 14-30 P plug, ready for connection to a 120/208-240 V, 15 A, 60 Hz, AC power supply.

The proper outlet can be purchased from an electrical supply dealer or from Miele (request a NEMA 14-30 R receptacle).

## "EASY INSTALLATION KIT"

If a dedicated 4 wire, 120/208-240 V, 15 Amp line is not available for this appliance, an optional "Easy Installation Kit" will allow you to connect to a 240 V, 30 Amp line.

This dual receptacle, wall mounted connection box can **ONLY** be used for connecting a Miele clothes washer and a Miele clothes dryer to an existing 30 Amp outlet.

057B for on-site outlet NEMA 10-30 R  
060B for on-site outlet NEMA 14-30 R

For more information on the "Easy Installation Kit," or if you have questions concerning the electrical connection, please contact Miele's Technical Service.

When contacting the Technical Service,  
please quote the model and serial number  
of your appliance.

---



**Miele, Inc.** 

**National Headquarters**

9 Independence Way  
Princeton, NJ 08540  
Phone: 800-843-7231  
609-419-9898  
Fax: 609-419-4298  
[www.miele.com](http://www.miele.com)

**Technical Service & Support  
Nationwide**

Phone: 800-999-1360  
Fax: 888-586-8056

**Miele Limited** 

**Headquarters and Showroom**

161 Four Valley Drive  
Vaughan, ON L4K 4V8  
Phone: 800-643-5381  
905-660-9936  
Fax: 905-532-2290  
[www.miele.ca](http://www.miele.ca)  
[info@miele.ca](mailto:info@miele.ca) (general enquiries)  
[professional@miele.ca](mailto:professional@miele.ca) (commercial enquiries)

**MieleCare National Service**

Phone: 800-565-6435  
905-532-2272  
Fax: 905-532-2292  
[service@miele.ca](mailto:service@miele.ca) (technical enquiries)