



NEW 18"/24"/30"/36"W. INTEGRATED ALL FREEZER

FDFZIC

PROFESSIONAL FEATURES

- Uniform air circulation maintains consistent temperatures
 - Ensures food stored in different compartments gets equal treatment
 - Maintains temperature to within 1°F to keep food fresher longer
- Extremely quiet compressor system with electronic controls
- Compressor located on the bottom allows for full integration of the product
- Temperature Range: 9°F (-13°C) to -9°F (-23°C)
- Innovative touch control maintains consistent temperature in the compartments
- Easy user interface allows for personalization of settings
 - Special Modes include Max Freezer, Max Ice, Bottle Chiller, Sabbath, Vacation
- Side and top mounted energy-efficient LED lighting enhances visibility
- Dual size ice maker
 - Easily switch between medium and large ice cubes
 - Max Ice Mode temporarily increase ice cube production for 24 hours
 - Water filter provides pure water for ice production
- *Patented Easy Lift Shelf Position System* adds storage flexibility
- Two adjustable glass shelves, four storage drawers, two adjustable door bins



FDFZIC7360L
(shown with custom panel)

DESIGN FEATURES

- *Proprietary Fully Articulating Hinge* has three-dimensional adjustability for a perfect fit in integrated installations
- Hinge damper allows for smoothness when opening and closing door
- Unit is custom panel ready to accept matching cabinetry panels or the Viking Professional and RVL Door Panel Kits

MODEL NUMBERS

- FDFZIC7180L – 18"W. Integrated All Freezer, Custom Panel; Left Hinge
- FDFZIC7180R – 18"W. Integrated All Freezer, Custom Panel; Right Hinge
- FDFZIC7240L – 24"W. Integrated All Freezer, Custom Panel; Left Hinge
- FDFZIC7240R – 24"W. Integrated All Freezer, Custom Panel; Right Hinge
- FDFZIC7300L – 30"W. Integrated All Freezer, Custom Panel; Left Hinge
- FDFZIC7300R – 30"W. Integrated All Freezer, Custom Panel; Right Hinge
- FDFZIC7360L – 36"W. Integrated All Freezer, Custom Panel; Left Hinge
- FDFZIC7360R – 36"W. Integrated All Freezer, Custom Panel; Right Hinge

ACCESSORIES

- PHK528-SS – Professional Stainless Steel handle (1 piece/28")
- RWFIC – Replacement Water Filter

WARRANTY

- 2-year full covers complete unit
- 6-year full – sealed refrigeration system
- 90-day full – cosmetic parts such as glass, painted items, and decorative items
- 12-year limited – sealed refrigeration system



NEW 18"/24"/30"/36"W. INTEGRATED ALL FREEZER

FDFZIC

PROFESSIONAL DOOR PANEL KITS

- VI7184CDP* – 18"W. Integrated Column Door Panel Kit with Handle, Field Reversible
- VI7244CDP* – 24"W. Integrated Column Door Panel Kit with Handle, Field Reversible
- VI7304CDP* – 30"W. Integrated Column Door Panel Kit with Handle, Field Reversible
- VI7364CDP* – 36"W. Integrated Column Door Panel Kit with Handle, Field Reversible

DOOR PANEL COLOR FINISHES*

- Stainless Steel (SS)



- Available in 18 Exclusive Color Finishes: Antique Bronze (AN), Blush (BH), Cast Black (CS), Daffodil (DA), Damascus Gray (DG), Eucalyptus (EU), Golden Hour (GH), Ivy (IV), Martini (MA), Nantucket (NA), November Sky (NS), Onyx (ON), Pure White (PW), Slate Blue (SB), Spiced Cider (SC), Splash (SP), Squall (SQ), and Valentine (VA)



RVL DOOR PANEL KITS

- MVI6184CDP(R/L)** – 18"W. Column Door Panel Kit with Handle, Right or Left Hinge
- MVI6244CDP(R/L)** – 24"W. Column Door Panel Kit with Handle, Right or Left Hinge
- MVI6304CDP(R/L)** – 30"W. Column Door Panel Kit with Handle, Right or Left Hinge
- MVI6364CDP(R/L)** – 36"W. Column Door Panel Kit with Handle, Right or Left Hinge

RVL DOOR PANEL FINISHES**

- Black Glass (BG) and Stainless Steel (SS)



18"/24"/30"/36"W. INTEGRATED ALL FREEZER

DESCRIPTION	FDFZIC7180	FDFZIC7240	FDFZIC7300	FDFZIC7360
Overall Width	17-7/8 (45.5 cm)	23-7/8" (60.8 cm)	29-7/8" (76.0 cm)	35-7/8" (91.2 cm)
Overall Height (from Bottom)	83-1/2" (212.1 cm) min. to 84-1/2" (214.6 cm) max.			
Overall Depth from Rear	To front edge of side trim: 22" (56.0 cm) To front of top grille: 24" (61.0 cm)			
Cutout Width	18" (45.7 cm)	24" (61.0 cm)	30" (76.2 cm)	36" (91.4 cm)
Cutout Height	84" (213.4 cm) min. to 84-1/16" (213.5 cm) max.			
Cutout Depth	24" (61.0 cm) plus panel thickness			
Electrical Requirements	115 volt, 60 Hz, 15 amp dedicated circuit; 3-wire cord with grounded 9 ft. 3-prong plug attached to product			
Maximum Amp Usage	9.9 amps			
Inlet Water Requirements	1/4" copper tubing inlet waterline; minimum 20 psi; maximum 120 psi			
Overall Interior Capacity	7.9 cu. ft.	12.1 cu. ft. (223.7 L)	16.0 cu. ft. (453.1 L)	20.14 cu. ft. (570.3 L)
Maximum Panel Weight	75 lbs. (34 kg)			
Approximate Shipping Weight	326 lbs. (147.9 kg)	355 lbs. (152.0 kg)	386 lbs. (175.1 kg)	445 lbs. (201.8 kg)

Please do not prepare installation from brochure data only. See installation instructions for important clearance/installation information.



NEW 18"/24"/30"/36"W. INTEGRATED ALL FREEZER

FDFZIC

INSTALLATION CUTOUT FEATURES: PANEL-READY

A Minimum cutout height
84" (213.4 cm)

Cutout width

- 36" model: 36" (91.4 cm)
- 30" model: 30" (76.2 cm)
- 24" model: 24" (61.0 cm)
- 18" model: 18" (45.7 cm)

Minimum cutout depth

24" (61.0 cm) + panel thickness for flush installation

Area to be left clear for the anti-tipping brackets

5" (12.7 cm) for both right and left sides

B Appliance height
83-1/2" (212.0 cm) + 1" (2.5 cm)

A

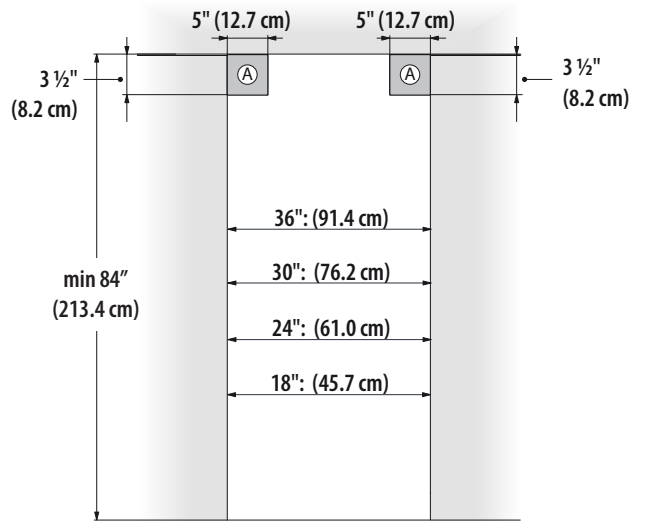

WIDTH OF APPLIANCE BODY

- 36" model: 34-7/8" (88.5 cm)
- 30" model: 28-7/8" (73.5 cm)
- 24" model: 23" (58.5 cm)
- 18" model: 17-1/8" (43.5 cm)

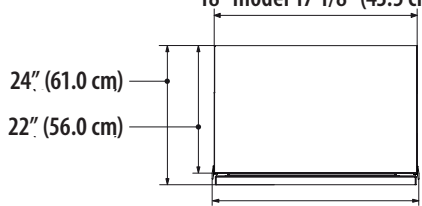

- 36" model: 35-7/8" (91.2 cm)
- 30" model: 29-7/8" (76.0 cm)
- 24" model: 23-7/8" (60.8 cm)
- 18" model: 17-7/8" (45.5 cm)

Width of appliance with mounting brackets installed (effective width)

B

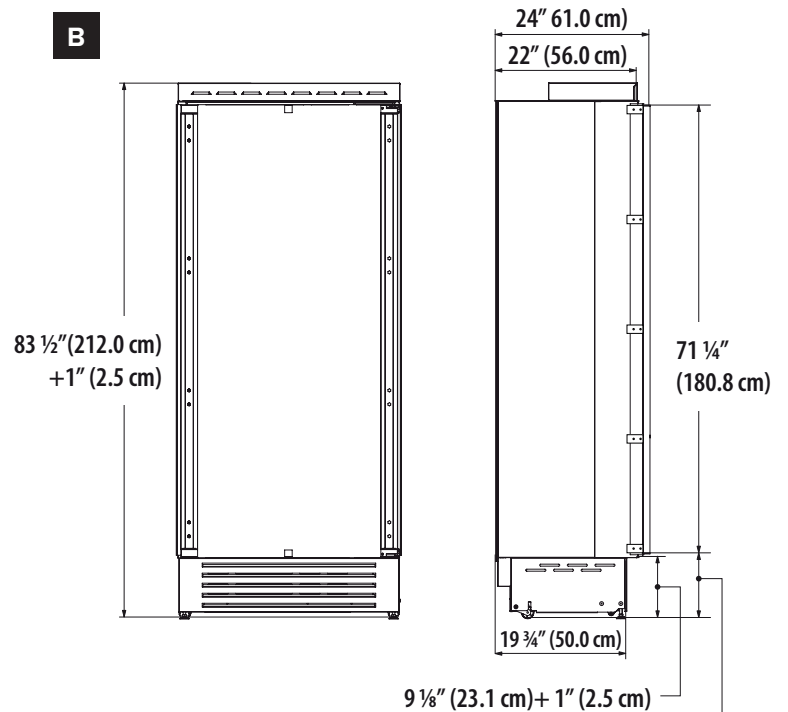



NEW 18"/24"/30"/36"W. INTEGRATED ALL FREEZER

FDFZIC

WIDTH	DOOR/DRAWER WIDTH A
36"	35-3/4" (90.8 cm)
30"	29-3/4" (75.6 cm)
24"	23-3/4" (60.4 cm)
18"	17-3/4" (45.1 cm)

Panels with thickness ranging between 3/4" (1.9 cm) and 1-1/8" (2.8 cm). Door panels with max weight of 75 lbs. (34 kg).

CUTOUT DIMENSIONS FOR COMBINED INSTALLATION

		A			
		18"	24"	30"	36"
B	18"	36" (91.4 cm)	42" (106.7 cm)	48" (122.0 cm)	54" (137.2 cm)
	24"	42" (106.7 cm)	48" (122.0 cm)	54" (137.2 cm)	60" (152.0 cm)
	30"	48" (122.0 cm)	54" (137.2 cm)	60" (152.0 cm)	66" (167.6 cm)
	36"	54" (137.2 cm)	60" (152.4 cm)	66" (167.6 cm)	72" (182.9 cm)

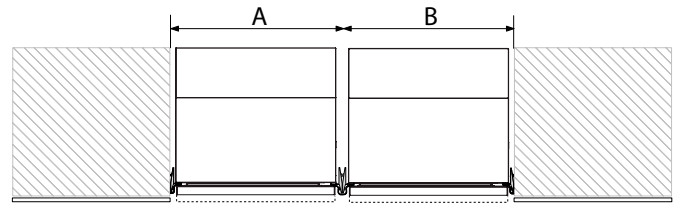
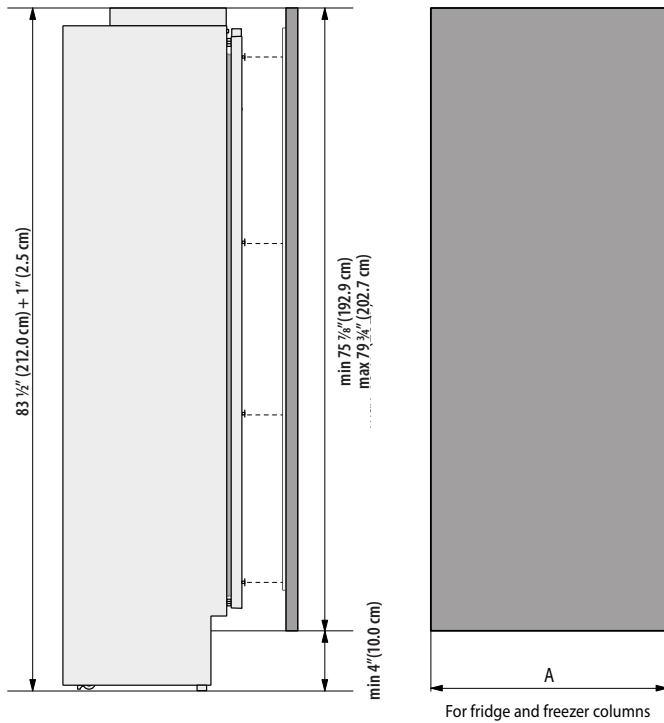

DOOR-SWING CLEARANCE

Door Swing Clearance

- 36" model: 58 5/8" (148.9 cm)
- 30" model: 52 5/8" (133.8 cm)
- 24" model: 46 3/4" (118.7 cm)
- 18" model: 40 3/4" (103.6 cm)

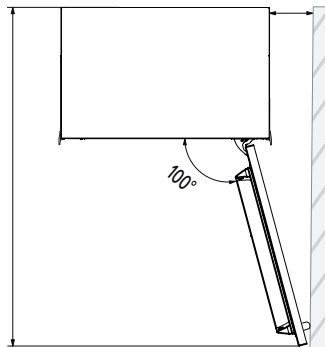

Minimum distance from the wall (hinge side)

- 36" model: 6 1/4" (15.9 cm)
- 30" model: 5 1/4" (13.2 cm)
- 24" model: 4 1/4" (10.8 cm)
- 18" model: 3 1/4" (8.2 cm)



VIKING RANGE, LLC 111 FRONT STREET GREENWOOD, MISSISSIPPI 38930 USA

For detailed product information, model numbers, or to request a quote call 1-888-845-4641 or visit vikingrange.com

© 2025 Viking Range, LLC All rights reserved. Specifications subject to change without notice.