

1000 CFM Inline Blower
VT11010W

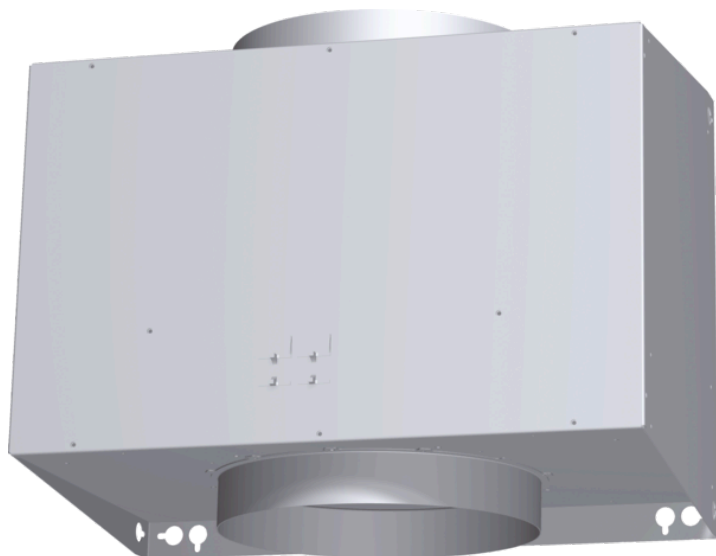

Product Features



Notes: Please refer to installation instructions. Installation instructions are available at www.thermador.com. Specifications are correct at the time of printing. Thermador reserves the right to change product specifications and design at any time, without notice.

1 800 735 4328 | WWW.THERMADOR.COM | 1901 Main Street, Suite 600 Irvine, CA 92614

©2018 BSH HOME APPLIANCES CORPORATION, ALL RIGHTS RESERVED LITHO DATE: 10/2018

1000 CFM Inline Blower
VTI1010W

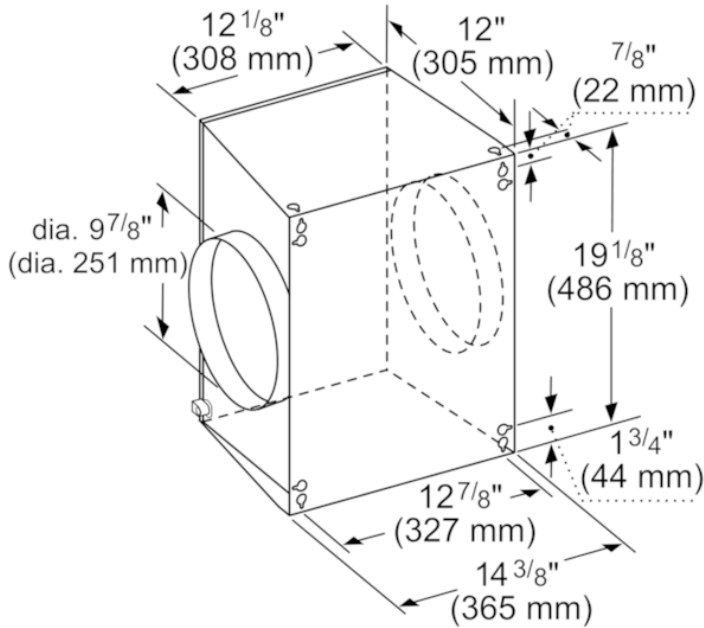

measurements in inches (mm)

Product Features

Product group	Accessory
Brand	Thermador
SKU	VTI1010W
Internal article number	VTI1010W
EAN code	825225941248
Product packaging dimensions (HxWxD) (in)	16 7/8" x 24 3/8" x 26 3/4"
Net weight (lbs)	31
Gross weight (lbs)	34
UPC code	825225941248
Name of product image	MCSA036808_VTI1010D_def.jpg

Technical Specification

Notes: Please refer to installation instructions. Installation instructions are available at www.thermador.com. Specifications are correct at the time of printing. Thermador reserves the right to change product specifications and design at any time, without notice.

1 800 735 4328 | WWW.THERMADOR.COM | 1901 Main Street, Suite 600 Irvine, CA 92614

©2018 BSH HOME APPLIANCES CORPORATION, ALL RIGHTS RESERVED LITHO DATE: 10/2018