

Viking Use & Care Manual

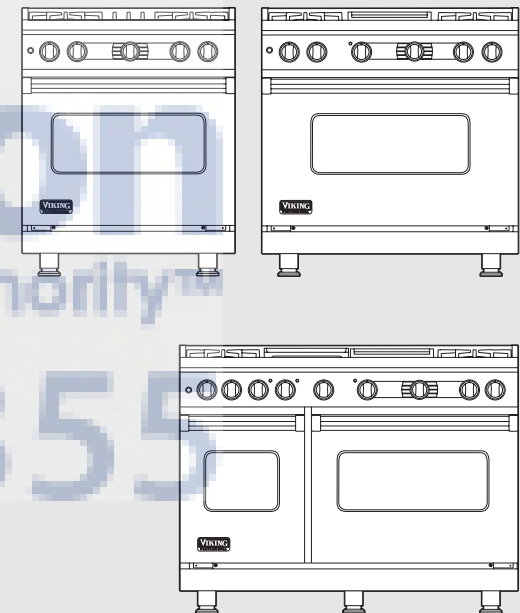

Viking Range Corporation
111 Front Street
Greenwood, Mississippi 38930 USA
(662) 455-1200

For product information,
call 1-888-VIKING1 (845-4641)
or visit the Viking Web site at
vikingrange.com



Professional Custom Freestanding Electronic Control Dual Fuel Ranges

Congratulations

Congratulations and welcome to the elite world of Viking ownership. We hope you will enjoy and appreciate the care and attention we have put into every detail of your new, state-of-the-art self-cleaning range.

Your Viking range is designed to offer years of reliable service. This Use and Care Manual will provide you with the information you need to become familiar with your range's care and operation.

Your complete satisfaction is our ultimate goal. If you have any questions or comments about this product, please contact the dealer from whom you purchased it, or contact our Consumer Support Center at 1-888-VIKING1 (845-4641).

We appreciate your choice of a Viking range and hope that you will again select our products for your other major appliance needs.

For more information about the complete and growing selection of Viking products, contact your dealer or visit us online at vikingrange.com.

Table of Contents

Getting Started

Warnings & Safety	4
Before Using Range	13

Product Controls

Range Features	14
Burner Configurations	16
Oven Features	17
Rack Positions	17

Operation

Surface Operation	18
Lighting Burners	18
Surface Burners/Automatic Re-Ignition	18
VariSimmer™	18
TruPower Plus™ Burner	18
Surface Heat Settings	19
Cooking Vessels	20
Griddle/Simmer Plate Operation	21
Griddle/Simmer Plate Clean Up & Care	21
Oven Functions and Settings	23
General Clock Display	25
Programming Clock	25
General Temp Display	26
Using the Oven	27
Set Oven Function and Temperature	27
Preheat	29
Timed Cook	30
Cook Time and Stop Time (Delay Cook)	31
Hold Mode	32
Timer Operation	33
Conventional and Convection Cooking	35
Baking	37
Roasting	42
Broiling	46
Convection Dehydrate/Defrost	50
Meat Probe	52

Product Care

Cleaning and Maintenance	54
Self-Clean Cycle	57
Replacing Oven Lights	59
Troubleshooting	60
Service Information	61
Warranty	62



Warnings & Safety

Warning and Important Safety Instructions appearing in this manual are not meant to cover all possible conditions and situations that may occur. Common sense, caution, and care must be exercised when installing, maintaining, or operating the appliance.

ALWAYS contact the manufacturer about problems or conditions you do not understand.

Recognize Safety Symbols, Words, Labels

⚠ DANGER
Hazards or unsafe practices which WILL result in severe personal injury or death
⚠ WARNING
Hazards or unsafe practices which COULD result in death or severe personal injury
⚠ CAUTION
Hazards or unsafe practices which COULD result in minor personal injury. All safety messages will identify the hazard, tell you how to reduce the chance of injury, and tell you what can happen if the instructions are not followed.

Read and follow all instructions before using this appliance to prevent the potential risk of fire, electric shock, personal injury or damage to the appliance as a result of improper usage of the appliance. Use appliance only for its intended purpose as described in this manual.

To ensure proper and safe operation: Appliance must be properly installed and grounded by a qualified technician. **DO NOT** attempt to adjust, repair, service, or replace any part of your appliance unless it is specifically recommended in this manual. All other servicing should be referred to a qualified servicer. Have the installer show you the location of the gas shutoff valve and how to shut it off in an emergency.

Warnings & Safety

⚠ WARNING

If the information in this manual is not followed exactly, a fire or explosion may result causing property damage, personal injury or death.

WHAT TO DO IF YOU SMELL GAS:

- **DO NOT** try to light any appliance.
- **DO NOT** touch any electrical switch.
- **DO NOT** use any phone in your building.
- Immediately call your gas supplier from a neighbor's phone. Follow the gas supplier's instructions.
- If you cannot reach your gas supplier, call the fire department.

Installation and service must be performed by a qualified installer, service agency or the gas supplier.

⚠ WARNING



TIPPING HAZARD

To reduce the risk of the appliance tipping, it must be secured by a properly installed anti-tip bracket(s). To make sure the bracket has been installed properly, look behind the range with a flashlight to verify proper installation engaged in the rear top left corner of the range.

- THIS RANGE CAN TIP
- INJURIES TO PERSONS CAN RESULT
- INSTALL ANTI-TIP DEVICE PACKED WITH RANGE
- SEE INSTALLATION INSTRUCTIONS

⚠ WARNING

DO NOT use commercial oven cleaners inside the oven. Use of these cleaners can produce hazardous fumes or can damage the porcelain finishes.

⚠ WARNING



To avoid risk of property damage, personal injury or death; follow information in this manual exactly to prevent a fire or explosion. **DO NOT** store or use gasoline or other flammable vapors and liquids in the vicinity of this or any appliance.

Warnings & Safety

To Prevent Fire or Smoke Damage

- Be sure all packing materials are removed from the appliance before operating it.
- Keep area around appliance clear and free from combustible materials, gasoline, and other flammable vapors and materials.
- If appliance is installed near a window, proper precautions should be taken to prevent curtains from blowing over burners.
- **NEVER** leave any items on the rangetop. The hot air from the vent may ignite flammable items and may increase pressure in closed containers which may cause them to burst.
- Many aerosol-type spray cans are **EXPLOSIVE** when exposed to heat and may be highly flammable. Avoid their use or storage near an appliance.
- Many plastics are vulnerable to heat. Keep plastics away from parts of the appliance that may become warm or hot. **DO NOT** leave plastic items on the rangetop as they may melt or soften if left too close to the vent or a lighted surface burner.
- Combustible items (paper, plastic, etc.) may ignite and metallic items may become hot and cause burns. **DO NOT** pour spirits over hot foods. **DO NOT** leave oven unsupervised when drying herbs, breads, mushrooms, etc; fire hazard.

In Case of Fire

Turn off appliance and ventilating hood to avoid spreading the flame. Extinguish flame, then turn on hood to remove smoke and odor.

- **Cooktop:** Smother fire or flame in a pan with a lid or cookie sheet.
- **NEVER** pick up or move a flaming pan.
- **Oven:** Smother fire or flame by closing the oven door.
DO NOT use water on grease fires. Use baking soda, a dry chemical or foam-type extinguisher to smother fire or flame.

Child Safety

- **NEVER** leave children alone or unsupervised near the appliance when it is in use or is still hot.
- **NEVER** allow children to sit or stand on any part of the appliance as they could be injured or burned.
- **DO NOT** store items of interest to children over the unit. Children climbing to reach items could be seriously injured.
- Children must be taught that the appliance and utensils in it can be hot. Let hot utensils cool in a safe place, out of reach of small children. Children should be taught that an appliance is not a toy. Children should not be allowed to play with controls or other parts of the appliance.

Warnings & Safety

Cooking Safety

- To eliminate the hazard of reaching over hot surface burners, cabinet storage should not be provided directly above a unit. If storage is provided, it should be limited to items which are used infrequently and which are safely stored in an area subjected to heat from an appliance. Temperatures may be unsafe for some items, such as volatile liquids, cleaners or aerosol sprays.
- **ALWAYS** place a pan on a surface burner before turning it on. Be sure you know which knob controls which surface burner. Make sure the correct burner is turned on and that the burner has ignited. When cooking is completed, turn burner off before removing pan to prevent exposure to burner flame.
- **ALWAYS** adjust surface burner flame so that it does not extend beyond the bottom edge of the pan. An excessive flame is hazardous, wastes energy and may damage the appliance, pan or cabinets above the appliance. This is based on safety considerations.
- **NEVER** leave a surface cooking operation unattended especially when using a high heat setting or when deep fat frying. Boilovers cause smoking and greasy spillovers may ignite. Clean up greasy spills as soon as possible. **DO NOT** use high heat for extended cooking operations.
- **NEVER** heat an unopened container on the surface burner or in the oven. Pressure build-up may cause container to burst resulting in serious personal injury or damage to the appliance.
- Use dry, sturdy pot-holders. Damp pot-holders may cause burns from steam. Dishtowels or other substitutes should **NEVER** be used as potholders because they can trail across hot surface burners and ignite or get caught on appliance parts.
- **ALWAYS** let quantities of hot fat used for deep fat frying cool before attempting to move or handle.
- **DO NOT** let cooking grease or other flammable materials accumulate in or near the appliance, hood or vent fan. Clean hood frequently to prevent grease from accumulating on hood or filter. When flaming foods under the hood, turn the fan off.
- **NEVER** wear garments made of flammable material or loose fitting or long-sleeved apparel while cooking. Clothing may ignite or catch utensil handles.
- **ALWAYS** place oven racks in the desired positions while oven is cool. Slide oven rack out to add or remove food, using dry, sturdy potholders. **ALWAYS** avoid reaching into the oven to add or remove food. If a rack must be moved while hot, use a dry potholder.
- **ALWAYS** turn the oven off at the end of cooking.
- Use care when opening the oven door. Let hot air or steam escape before moving or replacing food.

Warnings & Safety

Cooking Safety (cont.)

- **NEVER** use aluminum foil to cover oven racks or oven bottom. This could result in risk of electric shock, fire, or damage to the appliance. Use foil only as directed in this guide.
- **PREPARED FOOD WARNING:** Follow food manufacturer's instructions. If a plastic frozen food container and/or its cover distorts, warps, or is otherwise damaged during cooking, immediately discard the food and its container. The food could be contaminated.
- If you are "flaming" liquor or other spirits under an exhaust, **TURN THE FAN OFF.** The draft could cause the flames to spread out of control.
- Once the unit has been installed as outlined in the Installation Instructions, it is important that the fresh air supply is not obstructed. The use of a gas cooking appliance results in the production of heat and moisture in the room in which it is installed. Ensure that the kitchen is well-ventilated. Keep natural venting holes open or install a mechanical ventilation device. Prolonged or intensive use of the appliance may call for additional (such as opening a window) or more effective ventilation (such as increasing the level of a mechanical ventilation if present).

Utensil Safety

- Use pans with flat bottoms and handles that are easily grasped and stay cool. Avoid using unstable, warped, easily tipped or loose-handled pans. Also avoid using pans, especially small pans, with heavy handles as they could be unstable and easily tip. Pans that are heavy to move when filled with food may also be hazardous.
- Be sure utensil is large enough to properly contain food and avoid boilovers. Pan size is particularly important in deep fat frying. Be sure pan will accommodate the volume of food that is to be added as well as the bubble action of fat.
- To minimize burns, ignition of flammable materials and spillage due to unintentional contact with the utensil, **DO NOT** extend handles over adjacent surface burners. **ALWAYS** turn pan handles toward the side or back of the appliance, not out into the room where they are easily hit or reached by small children.
- **NEVER** let a pan boil dry as this could damage the utensil and the appliance.
- Follow the manufacturer's directions when using oven cooking bags.
- Only certain types of glass, glass/ceramic, ceramic or glazed utensils are suitable for rangetop surface or oven usage without breaking due to the sudden change in temperature. Follow manufacturer's instructions when using glass.

Warnings & Safety

Utensil Safety (cont.)

- This appliance has been tested for safe performance using conventional cookware. **DO NOT** use any devices or accessories that are not specifically recommended in this guide. **DO NOT** use eyelid covers for the surface units, stovetop grills, or add-on oven convection systems. The use of devices or accessories that are not expressly recommended in this manual can create serious safety hazards, result in performance problems, and reduce the life of the components of the appliance.
- The flame of the burner should be adjusted to just cover the bottom of the pan or pot. Excessive burner setting may cause scorching of adjacent counter-top surfaces, as well as the outside of the utensil. This is based on safety considerations.

Heating Elements

- **NEVER** touch oven heating elements, areas near elements, or interior surfaces of oven.
- Heating elements may be hot even though dark in color. Areas near elements and interior surfaces of an oven may become hot enough to cause burns.
- During and after use, **DO NOT** touch or let clothing or other flammable materials contact heating elements, areas near elements, or interior surfaces of oven until they have had sufficient time to cool.

Cleaning Safety

- Turn off all controls and wait for appliance parts to cool before touching or cleaning them. **DO NOT** touch the burner grates or surrounding areas until they have had sufficient time to cool.
- Clean appliance with caution. Use care to avoid steam burns if a wet sponge or cloth is used to wipe spills on a hot surface. Some cleaners can produce noxious fumes if applied to a hot surface.

Self-Clean Oven

- Clean only parts listed in this guide. **DO NOT** clean door gasket. The door gasket is essential for a good seal. Care should be taken not to rub, damage, or move the gasket. **DO NOT** use oven cleaners of any kind in or around any part of the self-clean oven.
- Before self-cleaning the oven, remove broiler pan, oven racks and other utensils and wipe up excessive spillovers to prevent excessive smoke, flare-ups or flaming.
- This range features a cooling fan which operates automatically during a clean cycle. If the fan does not turn on, cancel the clean operation and contact an authorized servicer.
- It is normal for the rangetop cooking surface of the range to become hot during a self-clean cycle. Therefore, touching the rangetop cooking surface during a clean cycle should be avoided.

Warnings & Safety

Important Safety Notice and Warning (State of California Proposition 65)

WARNING: This product contains one or more chemicals known to the State of California to cause cancer.

WARNING: This product contains one or more chemicals known to the State of California to cause birth defects or other reproductive harm. Users of this appliance are hereby warned that when the oven is engaged in the self-clean cycle, there may be some low-level exposure to some of the listed substances, including carbon monoxide. Exposure to these substances can be minimized by properly venting the oven to the outdoors by opening the windows and/or door in the room where the appliance is located during the self-clean cycle.

Important notice regarding pet birds:

NEVER keep pet birds in the kitchen or in rooms where the fumes from the kitchen could reach. Birds have a very sensitive respiratory system. Fumes released during an oven self-cleaning cycle may be harmful or fatal to birds. Fumes released due to overheated cooking oil, fat, margarine and overheated non-stick cookware may be equally harmful.

⚠ WARNING

NEVER use appliance as a space heater to heat or warm a room to prevent potential hazard to the user and damage to the appliance. Also, **DO NOT** use the rangetop or oven as a storage area for food or cooking utensils.

About Your Appliance

- For proper oven performance and operation, **DO NOT** block or obstruct the oven vent duct located on the right side of the air grille.
- Avoid touching oven vent area while oven is on and for several minutes after oven is turned off. When the oven is in use, the vent and surrounding area become hot enough to cause burns. After oven is turned off, **DO NOT** touch the oven vent or surrounding areas until they have had sufficient time to cool.
- Other potentially hot surfaces include rangetop, areas facing the rangetop, oven vent, surfaces near the vent opening, oven door, areas around the oven door and oven window.
- The misuse of oven doors (e.g. stepping, sitting, or leaning on them) can result in potential hazards and/or injuries.

KEEP THESE INSTRUCTIONS FOR FUTURE REFERENCE.

Warnings & Safety

⚠ WARNING



ELECTRICAL SHOCK HAZARD

DO NOT touch a hot oven light bulb with a damp cloth as the bulb could break. Should the bulb break, disconnect power to the appliance before removing bulb to avoid electrical shock.

⚠ WARNING



ELECTRICAL SHOCK HAZARD

Disconnect the electric power at the main fuse or circuit breaker before replacing bulb.

⚠ WARNING



BURN OR ELECTRICAL SHOCK HAZARD

Make sure all controls are "OFF" and oven is COOL before cleaning. Failure to do so can result in burns or electrical shock.

⚠ CAUTION

To avoid sickness and food waste, **DO NOT** allow defrosted food to remain in the oven for more than two hours.

⚠ NOTICE

DO NOT use the Oven Temperature Function during defrosting. Turning the convection fan on will accelerate the natural defrosting of the food without the heat.

⚠ CAUTION



BURN HAZARD

The oven door, especially the glass, can get hot. **Danger of burning: DO NOT touch the glass!**

Warnings & Safety

⚠ WARNING

This range features a self-cleaning cycle. During this cycle, the oven reaches elevated temperatures in order to burn off soil and deposits. A powder ash residue is left in the bottom of the oven after completion of the self-clean cycle.

Note: DO NOT use commercial oven cleaners inside the oven. Use of these cleaners can produce hazardous fumes or can damage the porcelain finishes. DO NOT line the oven with aluminum foil or other materials. These items can melt or burn during a self-clean cycle, causing permanent damage to the oven.

⚠ CAUTION



DO NOT touch the exterior portions of the oven after self-cleaning cycle has begun, since some parts become extremely hot to the touch!

During the first few times the self-cleaning feature is used, there may be some odor and smoking from the "curing" of the binder in the high-density insulation used in the oven. When the insulation is thoroughly cured, this odor will disappear. During subsequent self-cleaning cycles, you may sense an odor characteristic of high temperatures.

KEEP THE KITCHEN WELL-VENTED DURING THE SELF-CLEAN CYCLE.

⚠ CAUTION

You must carefully check the food during the dehydration process to ensure that it does not catch fire.

⚠ WARNING



BURN HAZARD

When self-cleaning, surfaces may get hotter than usual. Therefore, children should be kept away.

⚠ CAUTION

DO NOT store items of interest to children over the unit. Children climbing to reach items could be seriously injured.

Before Using Range

All products are wiped clean with solvents at the factory to remove any visible signs of dirt, oil, and grease which may have remained from the manufacturing process. Before starting to cook, clean the range thoroughly with hot, soapy water. There may be some burn off and odors on first use of the appliance—this is normal.

Oven

Important! Before first use, wipe interior with soapy water and dry thoroughly. Then set the oven selector to bake, the thermostat to 450°F, and operate for an hour.

All models include:

- A broad range of baking and broiling modes—up to eleven cooking modes in all—to make even your most challenging baking projects a success.
- Exclusive VSH™ Pro Sealed Burner System (VariSimmer™ to High)—combination of patented burner and top design provide cleanability plus superior performance at simmer and high.
- Exclusive one-piece tooled and porcelainized cooking surface contains spills for easy cleaning.
- Split baking and broiling elements—which reduces preheating time and provides greater control and more even heating.
- A reversing convection fan which is two times larger than most on the market—this allows you to cook foods more thoroughly and evenly—even when baking large quantities.
- Four convection modes offering greater air circulation to shorten cooking times and cook foods more evenly.
- Three broiling modes including a new low-broil mode for delicate broiling and top-browning.
- A profiled, concealed bake element for easier cleaning.
- This appliance is certified by Star-K to meet strict regulations in conjunction with specific instructions found on www.star-k.org

Range Features

Range Features

Product Controls

Product Controls

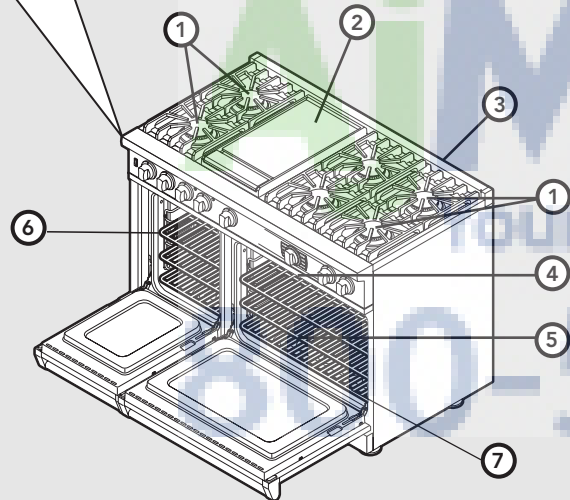
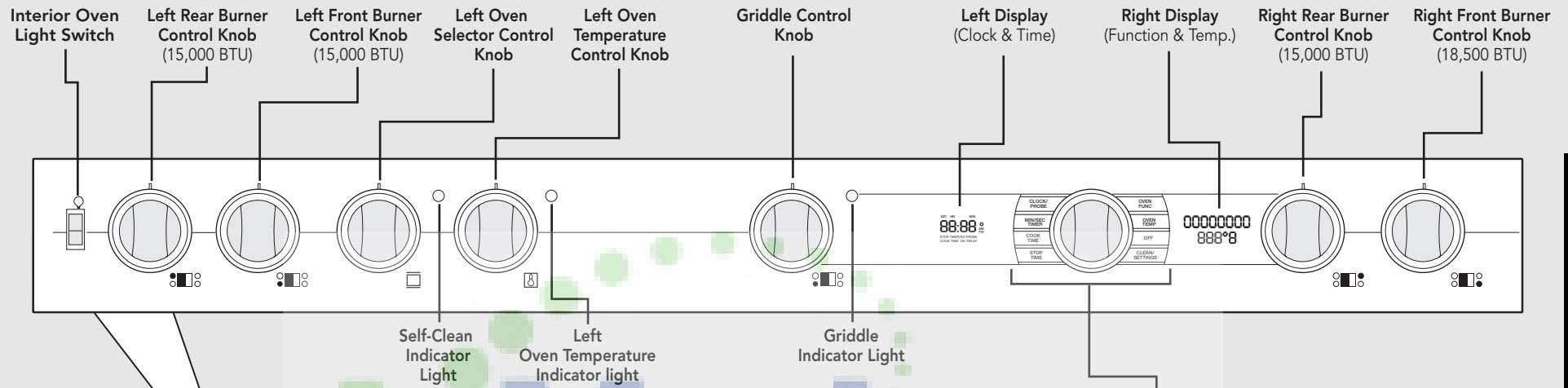

1. Six sealed burners with porcelain/ Cast iron caps and automatic ignition/Re-ignition
2. Griddle
3. Island trim
4. Identification plate
5. 30" Oven - Two TruGlide racks / One standard tilt-proof rack/six rack positions
6. 18" Oven - Three standard tilt-proof racks/six rack positions
7. Broiler pan-located inside oven

Note: VDSC548T6G model range shown here.

Right Selector Controls

Clock/Probe Button
Allows clock to be set to desired time. When probe is connected, use this button to set desired temperature.

Min/Sec Timer Button
Allows timer to be set to desired time.

Cook Time Button
Set a specific amount of time and a specific cooking function to be performed.

Stop Time Button
Set a delay bake time, giving an amount of time before baking begins and an amount of time for the duration of baking.

Oven Function Button
Set the appropriate oven function including: Bake, Convection Bake, TruConvex™, Broil, Convection Broil, Convection Roast, Auto Roast, Defrost, Dehydrate, Proof, and Self-Clean.

Oven Temp Button
Allows appropriate oven temperature to be set.

Off Button*
First press turns oven off. Second press turns off time display. Activates Control Lock if pressed in conjunction with Clear/Settings button.

Clear/Settings Button*
Press Clear to acknowledge an expired timer. Press Clear to cancel a function. When setting a function, time etc., press the Clear key to revert to previous setting.

***Note:** These keys have added importance.

Range Features

Burner Configurations

Denotes models which have a TruPower Plus™ 18,500 BTU Burner

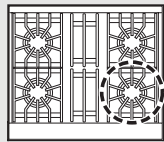

30" Four-Burner

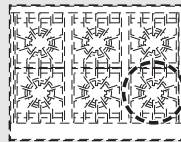

36" Six-Burner

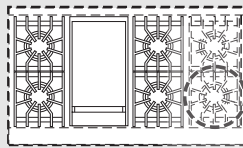

48" Six-Burner/Griddle

Product Controls

Oven Features

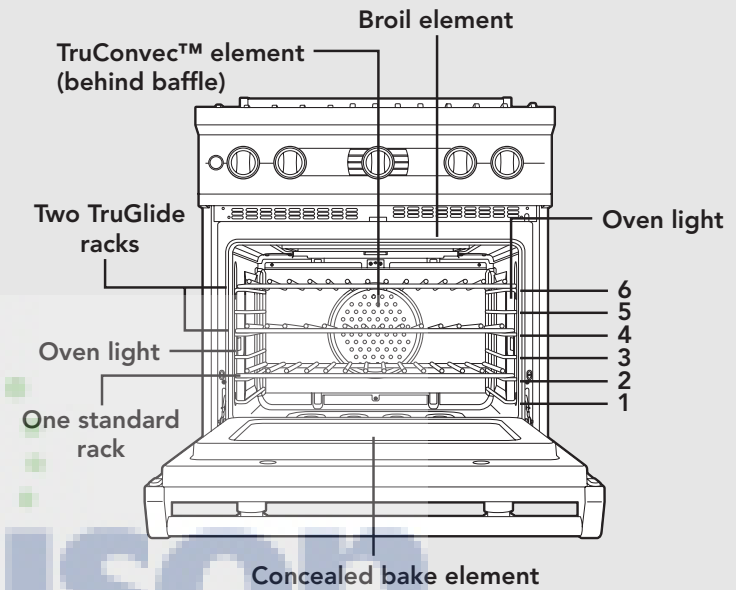

Product Controls

AjMadison
Your Appliance Specialist
800-570-5555

Rack Positions

Each 30" and 36" oven is equipped with two full extension glide racks and one standard rack. Each 18" oven is equipped with three standard tilt-proof racks. All ovens have six rack positions. Position 6 is the farthest from the oven bottom. Position 1 is the closest to the oven bottom. The racks can be easily removed and arranged at various levels. For best results with conventional baking, **DO NOT** use more than one rack at a time. It is also recommended, when using two racks, to bake with the racks in positions 2 and 4 or positions 3 and 5.

Surface Operation

Lighting Burners

All burners are ignited by electric ignition using the exclusive SureSpark™ Ignition system, offering consistent and reliable ignition every time. There are no open-flame, "standing" pilots.

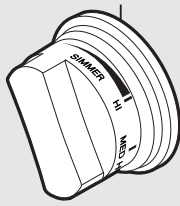

Surface Burners/Automatic Re-Ignition

To light the surface burners, push and turn the appropriate control knob counter clockwise to any position. This control is both a gas valve and an electric switch. Burners will ignite at any "ON" position with the automatic re-ignition system. If the flame goes out for any reason, the burners will automatically re-ignite if the gas is still flowing. When gas is permitted to flow to the burners, the electric igniters start sparking. On all surface igniters you should hear a "clicking" sound. If you do not, turn off the control and check that the unit is plugged in and that the fuse or circuit breaker is not blown or tripped.

Within a few moments, enough gas will have traveled to the burner to light. When the burner lights, turn the burner control to any position to adjust the flame size. Setting the proper flame height for the desired cooking process and selecting the correct cooking vessel will result in superior cooking performance, while also saving time and energy.

VariSimmer™

Simmering is a cooking technique in which foods are cooked in hot liquids kept at or just barely below the boiling point of water. Simmering ensures gentler treatment than boiling to prevent food from toughening and/or breaking up. The size of the pan and the volume of food can have a significant effect on how high or low a flame is needed for simmering. For this reason, Viking range and rangetop burners are engineered with a VariSimmer setting. The VariSimmer setting is not just one simmer setting, but provides a variable range of simmer settings. This variable range of simmer settings allows you to adjust the flame height to achieve the best simmer depending on the type and quantity of food being simmered. It is this ability that makes the VariSimmer setting the most accurate and trustworthy simmer on the market.

TruPower Plus™ Burner (where applicable)

Certain model ranges are equipped with a TruPower Plus 18,500 BTU burner in the front right burner position. This burner is designed to provide extra high heat output, especially when using large pans, and should be used for boiling large quantities or if you need to bring something to a boil quickly. While TruPower Plus burner has the extra power needed to bring large quantities of liquid to a boil rapidly, it is also able to be turned down low enough to provide a very low and delicate simmer making this burner the most versatile on the market.

Surface Operation

Surface Cooking Tips

- Use low or medium flame heights when cooking in vessels that are poor conductors of heat, such as glass, ceramic, and cast-iron. Reduce the flame height until it covers approximately 1/3 of the cooking vessel diameter. This will ensure more even heating within the cooking vessel and reduce the likelihood of burning or scorching the food.
- Reduce the flame if it is extending beyond the bottom of the cooking vessel. A flame that extends along the sides of the vessel is potentially dangerous, heats the utensil handle and kitchen instead of the food, and wastes energy.
- Reduce the flame height to the minimum level necessary to perform the desired cooking process. Remember that food cooks just as quickly at a gentle boil as it does at a rolling boil. Maintaining a higher boil than is necessary wastes energy, cooks away moisture, and causes a loss in food flavor and nutrient level.
- The minimum pot or pan (vessel) diameter recommended is 6" (15 cm). Use of pots or pans as small as 4" (10 cm) is possible but not recommended.

Surface Heat Settings*

Heat Setting	Use
Simmer	Melting small quantities Steaming rice Simmering sauces
Low	Melting large quantities
Med Low	Low-temperature frying (eggs, etc.) Simmering large quantities Heating milk, cream sauces, gravies, and puddings
Med	Sauteing and browning, braising, and pan-frying Maintaining slow boil on large quantities
Med High	High-temperature frying Pan broiling Maintaining fast boil on large quantities
High	Boiling water quickly Deep-fat frying in large utensil

***Note:** The above information is given as a guide only. You may need to vary the heat settings to suit your personal requirements.

Surface Operation

Cooking Vessels

Each cook has his or her own preference for the particular cooking vessels that are most appropriate for the type of cooking being done. Any and all cooking vessels are suitable for use in the range and it is not necessary to replace your present domestic vessels with commercial cookware. This is a matter of personal choice. As with any cookware, yours should be in good condition and free from excessive dents on the bottom to provide maximum performance and convenience.

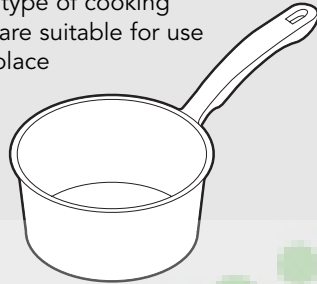

Note: When using big pots and/or high flames, it is recommended to use the front burners. There is more room in the front and potential cleanup at rear of appliance due to staining or discoloration will be minimized.

Griddle/Simmer Plate (on applicable models)

The optional 15,000 BTU griddle is constructed of machined steel with a blanchard finish and is uniquely designed to offer excellent cooking performance as well as easy clean up. The griddle is equipped with an electronic thermostat to maintain an even temperature across the griddle once the desired temperature has been set. The griddle has a power "ON" indicator light which glows when the griddle thermostat has been turned on. This will cycle on and off as needed to indicate the thermostat is maintaining the selected temperature. Before the griddle is used it is important to season the griddle. This seasoning process will change the appearance of the griddle plate. However, it will also prevent food from sticking and protect the surface from moisture.

Seasoning the Griddle Before the First Use

- Scrub the griddle plate with a mixture of one quart warm water and 1/4 cup white vinegar, using a blue Scotch-Brite™ pad. Dry thoroughly.
- Wash griddle with warm, soapy water. Rinse off and dry thoroughly.
- Season griddle by thinly coating the surface with approximately 1/2 to 1 teaspoon unsalted vegetable oil. Apply to entire griddle using a paper towel or clean cloth. Let oil sit on griddle for approximately 1 hour and then wipe with a clean cloth or paper towel to absorb any residual oil. The griddle is now ready to be used.

Surface Operation

Griddle/Simmer Plate Operation

- Turn the griddle control knob counterclockwise to the desired temperature setting. The power "ON" indicator light will glow indicating the griddle thermostat is on.
- The double griddle has two thermostat control knobs which control separate burners located beneath the griddle.
- When the griddle has reached the desired temperature, the power "ON" indicator light will turn off indicating the griddle is preheated to the selected temperature.
- Use liquid cooking oil or butter for eggs, pancakes, French toast, fish and sandwiches to prevent sticking.
- Routinely scrape loose food particles with a metal spatula during cooking to make the cleanup easier and to avoid the particles mixing with the food.
- To turn the griddle off, turn the thermostat knob clockwise to the "OFF" position.
- ALWAYS turn to the "OFF" position when not in use and lower the heat between cooking loads.

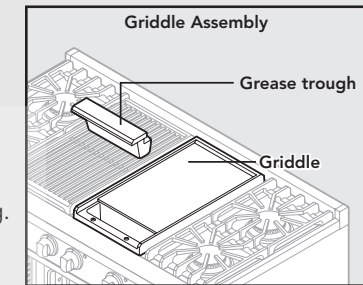

Griddle/Simmer Plate Clean Up & Care

- It is not necessary to wash the griddle after every use. When light cooking is performed and AFTER the griddle has cooled, simply wipe down the surface with a clean cloth or paper towel. The oils in the food which cooked on the griddle surface will naturally season the griddle providing a "natural" non-stick surface.
- After heavy cooking is completed and the griddle is still warm enough to create steam, pour a small amount of club soda at room temperature directly on the griddle. Using a metal spatula, pull oils and food particles toward the trough in front. Wipe entire surface with a paper towel. Follow with the seasoning process of applying oil.
- Keeping the griddle well seasoned will prevent the griddle from developing surface rust. If the griddle is not used for a period of time, it must be re-seasoned. The griddle must be re-seasoned each time after it is washed.
- Non-stick cooking spray is not recommended as it contains a high water content that has a tendency to burn quickly.
- Corn oil is not recommended as it has a high sugar level. It will caramelize and burn on the surface making it very difficult to remove.

Surface Operation

Griddle/Simmer Plate Clean Up & Care (cont.)

- After using the griddle, always remove the grease trough located in the front. Simply pull the trough towards you and lift out. Be sure to allow all surfaces to cool before removing the grease trough. The trough or tray trap needs to be cleaned after each use. A fire hazard may occur if grease is accumulated in the trough.
- Note - it is normal for the griddle to darken over time. This is the sign of a well seasoned griddle.
- Important: Never flood a hot griddle with cold water. This thermal shock promotes griddle warping and can cause the griddle to crack if continued over a period of time.
- For heavy duty cleaning, Viking offers a Griddle Cleaning Kit (model #GCK). This fast and effective commercial grade cleaning system will clean your griddle in a matter of minutes. To order, contact your local Viking dealer or order on the Viking website at vikingrange.com.

Griddle Cooking Chart

Food	Temp (°F)	Temp (°C)
Eggs	250-300	121-149
Bacon	300-325	149-163
Pancakes	375-400	191-205
French Toast	400	205
Fish Fillets	300	149
Hamburger	350	177
Steaks	350	177

Oven Functions and Settings

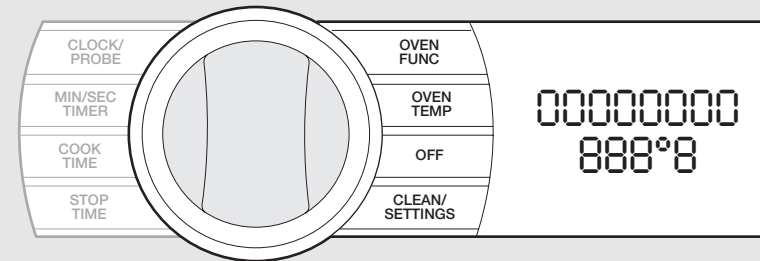

BAKE (Two-Element Bake)

Use this setting for baking, roasting, and casseroles.

BAKE

CONV BAKE (Convection Bake)

Use this setting to bake and roast foods at the same time with minimal taste transfer.

CONV BAKE

TRU CONV (TruConv™)

Use this bake setting for multi-rack baking for breads, cakes, cookies (up to 6 racks of cookies at once).

TRU CONV

CONV ROAST (Convection Roast)

Use this setting for roasting whole turkeys, whole chickens, hams, etc.

CONV ROAST

AUTO ROAST (Auto Roast)

Automatic searing of the outside of meats, simplifies roasting.

AUTO ROAST

CONV BROIL-HI (Convection Broil)

Use this setting to broil thick cuts of meat more quickly than conventional broil. Meats are seared on the outside retaining more juices and natural flavor with less shrinkage. Temperature is pre-set at 550°F (290°C).

CONV BRL HI

CONV BROIL-MED (Convection Broil)

Use this setting for searing seafood. Temperature is pre-set at 450°F (230°C).

CONV BRL MD

CONV BROIL-LO (Convection Broil)

Use this setting for garlic bread. It allows the butter to soak into the bread without burning. Temperature is pre-set at 350°F (180°C).

CONV BRL LO

Oven Functions and Settings

HI BROIL

Use this setting for broiling dark meats at 1" thickness or less where rare or medium doneness is desired. Temperature is pre-set at 550°F (290°C).

BROIL HI

MED BROIL

Use this setting for broiling white meats such as chicken or meats greater than 1" thick that would be over-browned in high broil. Temperature is pre-set at 450°F (230°C).

BROIL MED

LOW BROIL

Use this setting for delicate broiling such as meringue. Temperature is pre-set at 350°F (180°C).

BROIL LOW

TRU CONV DEHYDRATE (Convection Dehydrate)

Use this function to dehydrate fruits and vegetables. Temperature can be set between 90° and 110°F (32° to 44°C).

DEHYDRATE

TRU CONV DEFROST (Convection Defrost)

Use this function to defrost foods.

DEFROST

PROOF

Use this setting to allow yeast dough to rise. Temperature can be set between 90° and 110°F (32° to 44°C).

PROOF

SELF CLEAN

Use this function to clean oven.

SELF-CLEAN

Oven Functions and Settings

Clock Display (General)

When AC power is applied (including after a power loss), CLOCK display shows a flashing "12:00" and begins incremental time. Once set, clock is "ON" or "OFF" based on user's last setting.

Clock Display
SET HR MIN
12:00 ○ AM PM
STOP TIMER NO PROBE
COOK TIME ON DELAY

To turn "ON": If time is off, any key press will turn on TIME display. When range is turned "ON" following the selection of FUNCTION or TEMPERATURE, TIME display turns "ON".

To turn "OFF": Turn the range "OFF". If TIME is on display, a second press of "OFF" button will turn off TIME display.

Programming Clock

(Clock defaults to 12:00 and flashes when first powered up or if power is interrupted.)

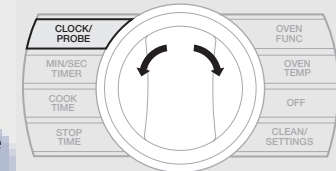

1. Press "CLOCK/PROBE" button. The clock display will flash.
2. Toggle "SELECTOR" right to increase or left to decrease to set desired time. Time will scroll in 1 minute increments per individual toggle. If "SELECTOR" is held in either right or left position, time will increase or decrease in 10 minute increments until desired time is reached. Clock automatically rolls from AM to PM.
3. Push in "SELECTOR" to accept time and start timer or after 5 seconds, time will auto-accept.
(When clock is set and needs to be changed, press "CLOCK/PROBE" button and follow the two steps above. CLOCK display will flash when activated.)

Oven Functions and Settings

Temp Display (General)

Temperature Setting: 5°F (2°C) increments

Temperature Display:

Actual Temp (PREHEAT ONLY)	1°F (1°C) increments
Meat Probe Actual Temp	1°F (1°C) increments
Set Temp (all other cycles)	5°F (2°C) increments

Note: PREHEAT and MEAT PROBE are the only cycles where actual temperature is displayed. Otherwise display shows only set temperature.

Function/Temp Display
00000000
888°8

Using the Oven

Set Oven Function and Temperature

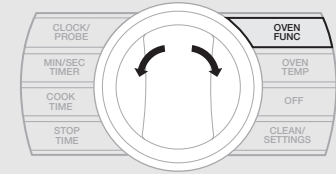

Set Oven Function:

1. Press "OVEN FUNCTION" button. (BAKE is set as default and flashes.)
2. Toggle "SELECTOR" left or right to desired oven function.
3. When desired oven function is flashing, push in "SELECTOR" to accept and advance to temperature settings. Exit with "OFF" button or auto exit after 5 seconds with no "SELECTOR" push.

Set Oven Temperature:

Once the oven function is selected, the FUNCTION display stops flashing and proceeds to temperature setting.

1. Toggle "SELECTOR" left to decrease or right to increase to desired oven temperature.
 - a. For BAKE and other functions with adjustable temperatures, default temperature (350°F) flashes. Turning "SELECTOR" will make adjustments in 5° increments. Turn and hold to increase or decrease in 5° and then 25° increments until desired temperature has been activated.
 - b. For CONVECTION BROIL and other functions with fixed temperature settings, default temperature is shown first. For example, CONVECTION BROIL 550°F. Toggle with "SELECTOR" to other available settings.
 - c. SELF CLEAN has no temperature adjustment.
2. When desired temperature is flashing, push in "SELECTOR" to accept desired oven temperature and start timer or after 5 seconds, temperature will auto accept (except SELF CLEAN). Once OVEN TEMPERATURE has been selected, it ceases to flash.
3. Display will intermittently display both set OVEN FUNCTION with set OVEN TEMPERATURE and PREHEAT and actual temperature until set temperature is reached at which point the set OVEN FUNCTION and set OVEN TEMPERATURE are locked in.
(Oven will not be activated until both OVEN FUNCTION and OVEN TEMPERATURE are set. Oven temperature can be changed at any time by pressing "OVEN TEMPERATURE" and repeating steps 1 and 2. Oven can be deactivated at any time by pressing "OFF" button.)

Using the Oven

Set Oven Function and Temperature (cont.)

Note: *OVEN TEMPERATURE* button does not need to be pushed as the program automatically moves to setting *OVEN TEMPERATURE* after *OVEN FUNCTION* is selected.

Note: *If an OVEN FUNCTION is not selected, control exits to comply with 2-step "ON" requirement.*

Note: *If no selection has been made in OVEN TEMPERATURE, oven auto-starts at default temperature.*

Temperature Range & Default

Function	Default Temperature	User Adjustment Range
Bake	350°F (180°C)	150° to 550°F (70° to 290°)
Convection Bake	325°F (160°C)	150° to 550°F (70° to 290°)
Tru Convection	325°F (160°C)	150° to 550°F (70° to 290°)
Convection Roast	325°F (160°C)	150° to 550°F (70° to 290°)
Convection Broil HI	550°F (290°C)	Fixed
Convection Broil MED	450°F (230°C)	Fixed
Convection Broil LOW	350°F (180°C)	Fixed
Broil HI	550°F (290°C)	Fixed
Broil MED	450°F (230°C)	Fixed
Broil LOW	350°F (180°C)	Fixed
Auto Roast	325°F (160°C)	150° to 550°F (70° to 290°)
Meat Probe	160°F (72°C)	120°F to 190°F (50° to 88°C)
Defrost	N/A	N/A Fan only
Dehydrate	90°F (32°C)	90° to 110° (32° to 44°C)
Proof	90°F (32°C)	90° to 110° (32° to 44°C)
Self Clean	Not displayed	Fixed

Note: *C° values are approximate.*

Note: *AUTO ROAST includes an automated SEARING function. Control operates at Set Point plus 100°F for the first 30 minutes, then reverts to set temperature. During the SEARING function, countdown timer does not count down.*

Note: *During SEARING function, display shows SEARING.*

Using the Oven

Preheat

For best results, it is extremely important that you preheat your oven to the desired cooking temperature before placing food items in the oven to begin cooking. In many cooking modes, partial power from the broiler is used to bring the oven to the preheat temperature. Therefore, placing food items in the oven during preheat mode is not recommended. The Viking Rapid Ready™ Preheat System is engineered so that the oven is brought to the desired set temperature in a manner which will provide the optimum cooking environment based on the selected cooking mode in the shortest possible time.

For instance, the preheat mode for TruConvec™ is designed to be brought up to the set point temperature in a different manner than the preheat mode for CONVENTIONAL BAKE. This is because TRUCONVEC is designed for multi-rack baking. So it is extremely critical that all rack positions have reached the desired cooking temperature. As a result, it is normal for oven to take slightly longer for the oven to preheat to 350°F (180°C) in TRUCONVEC mode when compared to the amount of time it takes to preheat to 350°F (180°C) in CONVENTIONAL BAKE mode.

Also, preheat time can vary based on some external factors such as room temperature and power supply. A significantly colder room temperature or a power supply less than 240 VAC can lengthen the time it takes for the oven to reach the desired set temperature.

Note: *While preheating, display will alternate between PREHEAT and FUNCTION and TEMPERATURE selected.*

Note: *PREHEAT is the only cycle where actual temperature is displayed, otherwise the display shows set temperature.*

Note: *Certain functions include a PREHEAT cycle. Once set temperature has been reached, the oven will automatically exit PREHEAT and follow NORMAL OPERATION mode.*

Using the Oven

Normal Operation

Once the FUNCTION and TEMPERATURE are set, and PREHEAT completes, oven will beep indicating set temperature has been reached and normal operation begins.

1. The display shows set temperature.
2. Oven temperature can be adjusted at any time by pressing "OVEN TEMPERATURE" button, then rotating "SELECTOR". Push in "SELECTOR" to accept or auto-accept after 5 seconds. If user wants to return to previous setting, press "CLEAR" key (as long as the SELECTOR has not been pushed in).
3. If oven is no longer at correct temperature due to opening oven door, control will revert to PREHEAT.

Timed Cook

During a TIMED COOK operation, the oven operates in conjunction with a count down timer.

1. Press "COOK TIME" button. (0:00 will display in clock display and COOK TIME will illuminate under display. HR will display above 0: and MIN will display above :00.)
2. Toggle "SELECTOR" right to increase or left to decrease to set desired time. Time will scroll in 1 minute increments per individual toggle. If "SELECTOR" is held in either right or left position, time will increase or decrease in 10 minute increments until desired time is reached.
3. Push in "SELECTOR" to accept time or after 5 seconds, time will auto-accept.
4. Set OVEN FUNCTION and OVEN TEMPERATURE as detailed in "Set Oven Function and Temperature" on page 23. (Timer will activate and count down once OVEN FUNCTION and OVEN TEMPERATURE have been activated. There will be an audible beep at 1 minute and 3 long beeps when time expires (0:00). Pressing "CLEAR" button will deactivate timer at any time.)

Note: Cook timer does not count down during PREHEAT mode.

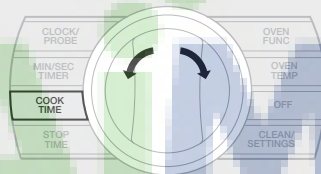

Clock Display

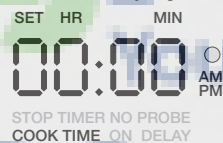

Madison
Appliance
800-570-5705

Using the Oven

Cook Time and Stop Time (Delay Cook)

With the Viking oven, you can choose what times you need to start and stop cooking your food. The COOK TIME and STOP TIME functions allow you to program your preferences.

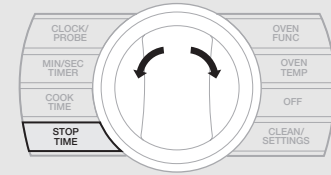

Here's how it works:

It is 2:00 PM and you would like to have your dinner ready at 6:00 PM. By programming your oven with a two-hour COOK TIME and 6:00 PM STOP TIME, your oven will delay cooking until 3:35 PM. It calculates START TIME by subtracting COOK TIME from STOP TIME. At 3:35, the oven will begin preheating. At 4:00 PM, the oven will begin its two-hour cook time.

Clock Display

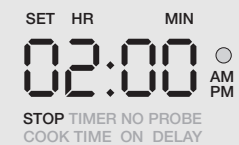

To Set Cook Time:

1. Press "STOP TIME" button. (Current time will flash and STOP will illuminate under display.)
2. Toggle "SELECTOR" right to increase or left to decrease to set desired time. Time will scroll in 1 minute increments per individual toggle. If "SELECTOR" is held in either right or left position, time will increase or decrease in 10 minute increments until desired time is reached.
3. Push in "SELECTOR" to accept time or after 5 seconds STOP TIME will auto-accept. Once accepted, the illuminated STOP TIME will go off and COOK TIME will illuminate under display. COOK TIME will display "0:00".
4. Set "COOK TIME" as detailed in "Timed Cook" on page 27.

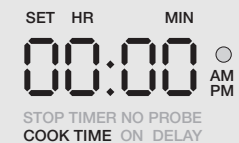

5. Set OVEN FUNCTION and TEMPERATURE FUNCTION as detailed in "Set Oven Function and Temperature" on page 23. (Once "OVEN FUNCTION" and OVEN TEMPERATURE have been selected and activated, their settings will be displayed during delay and through the cooking process. Timer will display programmed bake time. Below displayed bake time, "Delay"

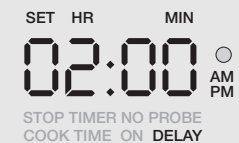

Using the Oven

Cook Time and Stop Time (Delay Cook) (cont.)

will be illuminated. Pressing "CLOCK/PROBE" button shows time while maintaining DELAY programming. There will be an audible beep at 1 minute and 3 long beeps when time expires (0:00). Pressing "CLEAR" button will deactivate timer at any time.)

Hold Mode

Automatically begins at end of TIMED COOK or DELAY COOK.

- Control sounds a short reminder beep, every 60 seconds and temperature is set at 150°.
- Display alternates between FUNCTION and HOLD. After 2 hours in HOLD mode, oven turns "OFF".

Using the Oven

Timer Operation

(Used to operate timer independently from oven)

- Press "MIN/SEC TIMER" button.
(0:00 will display. Timer will illuminate under display.)

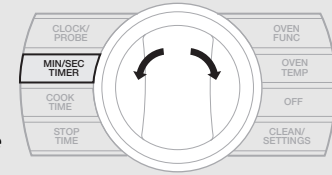

- Toggle "SELECTOR" right to increase or left to decrease to set the desired time. Time will scroll in 1 minute increments per individual toggle. If "SELECTOR" is held in either right or left position, time will increase or decrease in 10 minute increments until desired time is reached.

Clock Display

SET HR MIN
00:00 ○
AM PM
STOP TIMER NO PROBE
COOK TIME ON DELAY

- Push in "SELECTOR" to accept time or after 5 seconds "Stop Time" will auto-accept.
(Time will count down on display from programmed time. There will be an audible beep at 1 minute and three beeps when time expires (0:00). Pressing "CLEAR" button will deactivate timer at any time.)

Clear/Settings

This button has added features in addition from the button label.

- Press "CLEAR/SETTINGS" and hold 2 seconds to activate settings.
- Toggle "SELECTOR" right or left to desired custom setting. Setting selection will flash until accepted.
- Push in "SELECTOR" to accept desired setting or after 5 seconds, setting will auto-accept. Press "CLEAR/SETTINGS" to exit.

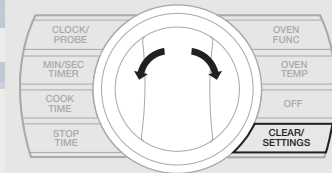

Custom Settings:

- F° or C° Select temperature format. Default is °F.
- 12/24hr Select time format. Default is 12hr.
- Sabbath Default is OFF.
- Brightness Select levels from 1-5 with 5 being the brightest. Default is 5.
- Showroom Disables heating elements.
- Exit Final step in user settings. From this step, exit from User Settings (press on "SELECTOR") or go to Advanced Settings

Note: See page 49 for additional details.

Using the Oven

Control Lock

This feature allows user to lock out control panel to prevent adjustments to the user settings.

1. To activate, press "OFF" and "CLEAR/SETTINGS" buttons simultaneously and hold for 5 seconds. There will be an audible "beep" and display panel will show LOCKED for 5 seconds, then all displays will be off.
2. To deactivate, press "OFF" and "CLEAR/SETTINGS" buttons simultaneously and hold for 5 seconds. There will be an audible "beep" and the control panel will be unlocked.

Note: Door lock will not work in conjunction with this function.

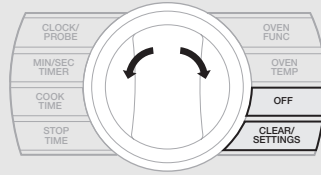

Using the Oven

Conventional and Convection Cooking

Because of variations in food density, surface texture and consistency, some foods may be prepared more successfully using the conventional bake setting. For this reason, conventional baking is recommended when preparing baked goods such as custard. The user may find other foods that are also prepared more consistently in conventional bake. This is perfectly normal. Convection cooking is a cooking technique which utilizes fan-forced air to circulate heat throughout the entire oven creating the optimum cooking environment. Cooking with convection is intended when performing multi-rack baking and for baking heavier foods. Below are tips which will allow you to get the best results out of your oven when cooking with convection.

- As a general rule, to convert conventional recipes to convection recipes, reduce the temperature by 25°F (-3.9°C) and the cooking time by approximately 10 to 15%.
- Cooking times for standard baking and convection baking will be the same. However, if using convection to cook a single item or smaller load, then it is possible to have 10-15% reduction in cooking time. (Remember convection cooking is designed for multi-rack baking or cooking large loads.)
- If cooking items which require longer than 45 minutes, then it is possible to see a 10-15% reduction in cooking time. This is especially true for large items cooked in the convection roast function.
- A major benefit of convection cooking is the ability to prepare foods in quantity. The uniform air circulation makes this possible. Foods that can be prepared on two of three racks at the same time include: pizza, cakes, cookies, biscuits, muffins, rolls, and frozen convenience foods.
- For three-rack baking, use any combination of rack positions 2, 3, 4, and 5. For two-rack baking, use rack positions 2 and 4 or positions 3 and 5. Remember that the racks are numbered from bottom to top. See "Oven Features" illustration on page 19.
- Items cooked in a convection function can be easily over-baked. This being the case, it is usually a good idea to pull items out of the oven just before they seem to be done. Items will continue to cook right after they are set out of the oven.

Using the Oven

Conventional and Convection Cooking (cont.)

- Some recipes, especially those that are homemade, may require adjustment and testing when converting from standard to convection modes. If unsure how to convert a recipe, begin by preparing the recipe in conventional bake. After achieving acceptable results, follow the convection guidelines listed for the similar food type. If the food is not prepared to your satisfaction during this first convection trial, adjust only one recipe variable at a time (cooking time, rack position, or temperature) and repeat the convection test. Continue adjusting one recipe variable at a time until satisfactory results are achieved.

Pan Placement Tips

- When using large (15" x 13") flat pans or trays that cover most of the rack, rack positions 2 or 3 produce the best results.
- When baking on more than one rack, it is recommended to use one of the convection modes and the 2nd and 4th position or the 3rd and 5th position for more even baking. When baking on three racks, use any combination of positions 2, 3, 4, and 5 for more consistent results.
- Stagger pans in opposite directions when two racks and several pans are used in conventional bake. If possible, no pan should be directly above another.
- Allow 1 to 2 inches of air space around all sides of each pan for even air circulation.

Single Rack Pan Placement

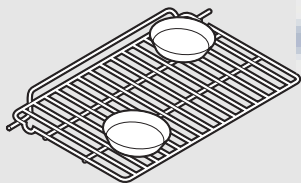

Multiple Rack Pan Placement

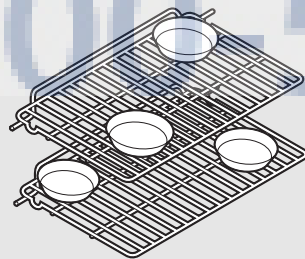

Baking

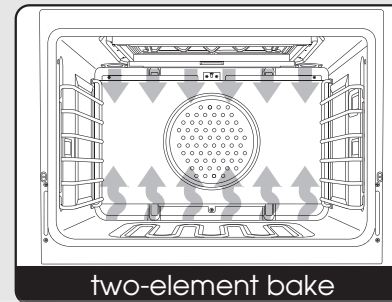

BAKE (Two-Element Bake)

Full power heat is radiated from the bake element in the bottom of the oven cavity and supplemental heat is radiated from the broil element. This function is recommended for single rack baking. Many cookbooks contain recipes to be cooked in the conventional manner. Conventional baking/

roasting is particularly suitable for dishes that require a high temperature. Use this setting for baking, roasting, and casseroles.



CONV BAKE (Convection Bake)

The bottom element operates at full power, and the top broil element operates at supplemental power. The heated air is circulated by the motorized fan in the rear of the oven providing a more even heat distribution. This even circulation of air equalizes the

temperature throughout the oven cavity and eliminates the hot and cold spots found in conventional ovens. A major benefit of convection baking is the ability to prepare food in quantity using multiple racks—a feature not possible in a standard oven.

When roasting using this setting, cool air is quickly replaced, searing meats on the outside and retaining more juices and natural flavor on the inside with less shrinkage. With this heating method, foods can be baked and roasted at the same time with minimal taste transfer, even when different dishes are involved, such as cakes, fish or meat. The hot air system is especially economical when thawing frozen food. Use this setting for baking and roasting.

Baking

TRU CONV (TruConvect™)

The rear element only operates at full power. There is no direct heat from the bottom or top elements. The motorized fan in the rear of the oven circulates air in the oven cavity for even heating. Use this setting for foods that require gentle cooking such as pastries, souffles, yeast breads, quick breads and cakes. Breads, cookies, and other baked goods come out evenly textured with golden crusts. No special bakeware is required. Use this function for single rack baking, multiple rack baking, roasting, and preparation of complete meals. This setting is also recommended when baking large quantities of baked goods at one time.

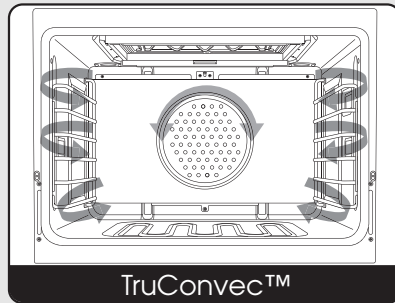

Baking Tips

- Make sure the oven racks are in the desired positions before you turn the oven on.
- **DO NOT** open the oven door frequently during baking. If you must open the door, the best time is during the last quarter of the baking time.
- Bake to shortest time suggested and check for doneness before adding more time. For baked goods, a stainless steel knife placed in the center of the product should come clean when done.
- Use the pan size and type recommended by the recipe to ensure best results. Cakes, quick breads, muffins, and cookies should be baked in shiny, reflective pans for light, golden crusts. Avoid the use of old, darkened pans. Warped, dented, stainless steel and tin-coated pans heat unevenly and will not give uniform baking results.

Proofing

This setting is designed for allowing yeast dough to rise to a temperature between 85°F (29°C) and 100°F (38°C). Yeast doughs rise or "proof" best when the temperature is between 85°F (29°C) and 100°F (38°C). To make sure the dough is warm enough, cover the bowl loosely with plastic wrap and/or cloth towel. Place the bowl on the center rack of the oven and close door. When you think the dough has doubled in size, lightly poke 2 fingers about 1/2" (1.3 cm) into the dough. If the indentation remains, the dough has risen enough.

Baking

Baking Chart

Food	Pan Size	Single Rack Position	Temp	Time (min)
Biscuits	Cookie sheet	3 or 4	400° F (204.4° C)	8 - 10
Yeast loaf	Loaf pan	3 or 4	375° F (190.6° C)	30 - 35
Yeast rolls	Cookie sheet	3 or 4	400° F (204.4° C)	12 - 15
Nut bread	Loaf pan	3 or 4	375° F (190.6° C)	30 - 35
Cornbread	8" x 8"	3 or 4	400° F (204.4° C)	20 - 25
Gingerbread	8" x 8"	3 or 4	350° F (176.7° C)	35 - 40
Muffins	Muffin tin	3 or 4	375° F (190.6° C)	15 - 20
Corn muffins	Muffin tin	3 or 4	375° F (190.6° C)	15 - 20
CAKES				
Angel food	Tube pan	3 or 4	375° F (190.6° C)	35 - 45
Bundt	Tube pan	3 or 4	350° F (176.7° C)	45 - 55
Cupcakes	Muffin pan	3 or 4	350° F (176.7° C)	16 - 20
Layer, sheet	13" x 9"	3 or 4	350° F (176.7° C)	40 - 50
Layer, two	9" round	3 or 4	350° F (176.7° C)	30 - 35
Pound	Loaf pan	3 or 4	350° F (176.7° C)	60 - 65
COOKIES				
Brownies	13" x 9"	3 or 4	350° F (176.7° C)	25 - 30
Choc. chip	Cookie sheet	3 or 4	375° F (190.6° C)	12 - 15
Sugar	Cookie sheet	3 or 4	350° F (176.7° C)	10 - 12
PASTRY				
Cream puffs	Cookie sheet	3 or 4	400° F (204.4° C)	30 - 35
PIES				
Crust, unfilled	9" round	3 or 4	425° F (218.3° C)	10 - 12
Crust, filled	9" round	3 or 4	375° F (190.6° C)	55 - 60
Lemon meringue	9" round	3 or 4	350° F (176.7° C)	12 - 15
Pumpkin	9" round	3 or 4	350° F (176.7° C)	40 - 45
Custard	6 - 4 oz cups	3 or 4	350° F (176.7° C)	35 - 40
ENTREES				
Egg rolls	Cookie sheet	3 or 4	400° F (204.4° C)	12 - 15
Fish sticks	Cookie sheet	3 or 4	425° F (218.3° C)	18 - 21
Lasagna, frz	Cookie sheet	3 or 4	375° F (190.6° C)	65 - 70
Pot pie	Cookie sheet	3 or 4	400° F (204.4° C)	35 - 40
Gr. peppers stuffed	13" x 9"	3 or 4	375° F (190.6° C)	65 - 70
Quiche	9" round	3 or 4	400° F (204.4° C)	25 - 30
Pizza, 12"	Cookie sheet	3 or 4	400° F (204.4° C)	15 - 20
Mac. & cheese, frz	Cookie sheet	3 or 4	375° F (190.6° C)	60 - 65
VEGETABLES				
Baked potatoes	On rack	3 or 4	375° F (190.6° C)	60 - 65
Spinach souffle	1 qt. casserole	3 or 4	350° F (176.7° C)	45 - 50
Squash	Cookie sheet	3 or 4	375° F (190.6° C)	50 - 55
French fries	Cookie sheet	3 or 4	425° F (218.3° C)	15 - 20

*Note: The above information is given as a guide only.

Baking

Convection Baking Chart

Food	Pan Size	Single Rack Position	Temp	Time (min)
BREADS				
Biscuits	Cookie sheet	2 & 4	375° F (190.6° C)	7 - 9
Yeast loaf	Loaf pan	2 & 4	350° F (176.7° C)	20 - 25
Yeast rolls	Cookie sheet	2 & 4	375° F (190.6° C)	11 - 13
Nut bread	Loaf pan	2 & 4	350° F (176.7° C)	20 - 25
Cornbread	8" x 8"	2 & 4	375° F (190.6° C)	15 - 20
Gingerbread	8" x 8"	2 & 4	325° F (162.8° C)	30 - 35
Muffins	Muffin tin	2 & 4	350° F (176.7° C)	12 - 15
Corn muffins	Muffin tin	2 & 4	350° F (176.7° C)	0 - 12
CAKES				
Angel food	tube pan	3 or 4	325° F (162.8° C)	30 - 35
Bundt	Tube pan	3 or 4	325° F (162.8° C)	35 - 40
Cupcakes	Muffin pan	2 & 4	325° F (162.8° C)	15 - 17
Layer, sheet	13" x 9"	2 & 4	325° F (162.8° C)	30 - 32
Layer, two	9" round	2 & 4	325° F (162.8° C)	25 - 30
Pound	Loaf pan	2 & 4	325° F (162.8° C)	5 - 50
COOKIES				
Brownies	13" x 9"	2 & 4	325° F (162.8° C)	20 - 25
Choc. chip	Cookie sheet	2,3,& 4	350° F (176.7° C)	7 - 10
Sugar	Cookie sheet	2,3,& 4	325° F (162.8° C)	9-10
PASTRY				
Cream puffs	Cookie sheet	2 & 4	375° F (190.6° C)	4 - 27
PIES				
Crust, untilled	9" round	2 & 4	400° F (204.4° C)	7 - 9
Crust, filled	9" round	2 & 4	350° F (176.7° C)	50 - 55
Lemon meringue	9" round	2 & 4	325° F (162.8° C)	4 - 5
Pumpkin	9" round	2 & 4	325° F (162.8° C)	35 - 45
Custard	6 - 4oz cups	2 & 4	325° F (162.8° C)	30 - 35
ENTREES				
Egg rolls	Cookie sheet	2 & 4	375° F (190.6° C)	8 - 10
Fish sticks	Cookie sheet	2 & 4	400° F (204.4° C)	13 - 16
Lasagna, frz	Cookie sheet	2 & 4	350° F (176.7° C)	60 - 65
Pot pie	Cookie sheet	2 & 4	375° F (190.6° C)	10 - 12
Gr. peppers stuffed	13" x 9"	2 & 4	350° F (176.7° C)	45 - 50
Quiche	9" round	2 & 4	375° F (190.6° C)	20 - 25
Pizza, 12"	Cookie sheet	2 & 4	375° F (190.6° C)	10 - 12
Mac. & cheese, frz	Cookie sheet	3 or 4	350° F (176.7° C)	45 - 50
VEGETABLES				
Baked potatoes	On rack	3 or 4	350° F (176.7° C)	45 - 50
Spinach souffle	1 qt. casserole	3 or 4	325° F (162.8° C)	35 - 40
Squash	Cookie sheet	3 or 4	350° F (176.7° C)	40 - 45
French fries	Cookie sheet	3 or 4	400° F (204.4° C)	10 - 15

***Note:** The above information is given as a guide only.

Solving Baking Problems

Baking problems can occur for many reasons. Check the chart below for the causes and remedies for the most common problems. It is important to remember that the temperature setting and cooking times you are accustomed to using with your previous oven may vary slightly from those required with this oven. If you find this to be true, it is necessary for you to adjust your recipes and cooking times accordingly.

Common Baking Problems/Remedies

Problems	Cause	Remedy
Cakes burned on the sides or not done in center	1. Oven was too hot 2. Wrong pan size 3. Too many pans	1. Reduce temperature 2. Use recom. pan size 3. Reduce no. of pans
Cakes crack on top	1. Batter too thick 2. Oven too hot 3. Wrong pan size	1. Follow recipe 2. Add liquid 3. Reduce temperature 4. Use recom. pan size
Cakes are not level	1. Batter uneven 2. Oven or rack not level 3. Pan was warped	1. Distribute batter even 2. Level oven or rack 3. Use proper pan
Food too brown on bottom	1. Oven door opened too often 2. Dark pans being used 3. Incorrect rack position 4. Wrong bake setting 5. Pan too large	1. Use door window to check food 2. Use shiny pans 3. Use recom. rack position 4. Adjust to conventional or convection setting as needed 5. Use proper pan
Food too brown on top	1. Rack position too high 2. Oven not preheated 3. Sides of pan too high	1. Use recom. rack position 2. Allow oven to preheat 3. Use proper pans
Cookies too flat	1. Hot cookie sheet	1. Allow sheet to cool between batches
Pies burned around edges	1. Oven too hot 2. Too many pans used 3. Oven not preheated	1. Reduce temperature 2. Reduce no. of pans 3. Allow oven to preheat
Pies too light on top	1. Oven not hot enough 2. Too many pans used 3. Oven not preheated	1. Increase temperature 2. Reduce no. of pans 3. Allow oven to preheat

Roasting

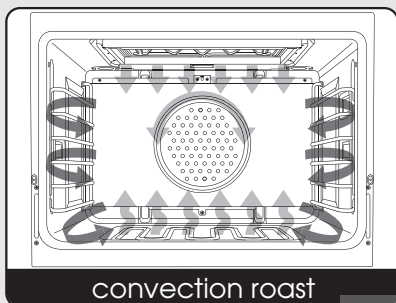

CONV ROAST* (Convection Roast)

The convection element runs in conjunction with the inner and outer broil elements. The reversible convection fan runs at a higher speed in each direction. This transfer of heat (mainly from the convection element) seals moisture inside of large roasts. A time savings is

gained over existing, single fan convection roast modes. Use this setting for whole turkeys, whole chickens, hams, etc.

***Note:** This function uses a high-speed convection fan for optimum cooking performance. Some noise may be noticed from this high fan speed. This is normal.

Note: You can also roast foods using bake settings. See the "Baking" section for additional information.

Roasting Tips

ALWAYS use the broiler pan and grid supplied with each oven. The hot air must be allowed to circulate around the item being roasted.

DO NOT cover what is being roasted. Convection roasting seals in juices quickly for a moist, tender product. Poultry will have a light, crispy skin and meats will be browned, not dry or burned. Cook meats and poultry directly from the refrigerator. There is no need for meat or poultry to stand at room temperature.

- As a general rule, to convert conventional recipes to convection recipes, reduce the temperature by 25°F (-3.9°C) and the cooking time by approximately 10 to 15%.
- **ALWAYS** roast meats fat side up in a shallow pan using a roasting rack. No basting is required when the fat side is up. **DO NOT** add water to the pan as this will cause a steamed effect. Roasting is a dry heat process.
- Poultry should be placed breast side up on a rack in a shallow pan. Brush poultry with melted butter, margarine, or oil before and during roasting.
- For convection roasting, **DO NOT** use pans with tall sides as this will interfere with the circulation of heated air over the food.
- If using a cooking bag, foil tent, or other cover, use the conventional bake setting rather than either convection setting.

Roasting

Roasting Tips (cont.)

- When using a meat thermometer, insert the probe halfway into the center of the thickest portion of the meat. (For poultry, insert the thermometer probe between the body and leg into the thickest part of the inner thigh.) The tip of the probe should not touch bone, fat, or gristle to ensure an accurate reading. Check the meat temperature halfway through the recommended roasting time. After reading the thermometer once, insert it ½ inch (1.3 cm) further into the meat, then take a second reading. If the second temperature registers below the first, continue cooking the meat.
- Roasting times **ALWAYS** vary according to the size, shape and quality of meats and poultry. Less tender cuts of meat are best prepared in the conventional bake setting and may require moist cooking techniques. Remove roasted meats from the oven when the thermometer registers 5°F (-15°C) to 10° F (-12°C) lower than the desired doneness. The meat will continue to cook after removal from the oven. Allow roasts to stand 15 to 20 minutes after roasting in order to make carving easier.

AUTO ROAST

Use this function to simplify roasting by automatically searing the outside of roasts.

1. See page 24 for instructions on accessing the Auto Roast function.

When Set Auto Roast Temperature is reached, one long beep will sound and the display will show "SEARING." The oven will remain at searing temperature (set temperature plus 100° F) for 30 minutes. If set, Cook Time timer will begin.

Roasting

Conventional Roasting Chart
(when using the Bake or Convection Bake setting)

Food	Weight	Temp	Time (min/lb)	Internal Temp
BEEF				
Rib roast				
Rare	4 - 6 lbs	325° F (162.8° C)	25	140° F (60.0° C)
Medium	4 - 6 lbs	325° F (162.8° C)	30	155° F (68.3° C)
Well done	4 - 6 lbs	325° F (162.8° C)	40	170° F (76.7° C)
Rump roast				
Medium	4 - 6 lbs	325° F (162.8° C)	25	155° F (68.3° C)
Well done	4 - 6 lbs	325° F (162.8° C)	30	170° F (76.7° C)
Tip roast				
Medium	3 - 4 lbs	325° F (162.8° C)	35	155° F (68.3° C)
Well done	3 - 4 lbs	325° F (162.8° C)	40	170° F (76.7° C)
LAMB				
Lamb leg	3 - 5 lbs	325° F (162.8° C)	30	180° F (82.2° C)
PORK				
Pork loin	3 - 5 lbs	325° F (162.8° C)	35	180° F (82.2° C)
Pork chops 1" thick	1 - 1 1/4 lbs	350° F (176.7° C)	55 - 60 total time	N/A
Ham, fully cooked	5 lbs	325° F (162.8° C)	18	130° F (54.4° C)
POULTRY				
Chicken, whole	3 - 4 lbs	375° F (190.6° C)	30	180° F (82.2° C)
Turkey, unstuffed	12 - 16 lbs	325° F (162.8° C)	16 - 20	180° F (82.2° C)
Turkey	20 - 24 lbs	325° F (162.8° C)	16 - 20	180° F (82.2° C)
Turkey, stuffed	12 - 16 lbs	325° F (162.8° C)	17 - 21	180° F (82.2° C)
Turkey, stuffed	20 - 24 lbs	325° F (162.8° C)	17 - 21	180° F (82.2° C)
Turkey breast	4 - 6 lbs	325° F (162.8° C)	20	180° F (82.2° C)

Note: The above information is given as a guide only.

Roasting

Convection Roasting Chart

Food	Weight	Temp	Time (min/lb)	Internal Temp
BEEF				
Rib roast				
Rare	4 - 6 lbs	325° F (162.8° C)	25	140° F (60.0° C)
Medium	4 - 6 lbs	325° F (162.8° C)	24	155° F (68.3° C)
Well done	4 - 6 lbs	325° F (162.8° C)	30	170° F (76.7° C)
Rump roast				
Medium	4 - 6 lbs	325° F (162.8° C)	20	155° F (68.3° C)
Well done	4 - 6 lbs	325° F (162.8° C)	24	170° F (76.7° C)
Tip roast				
Medium	3 - 4 lbs	325° F (162.8° C)	30	155° F (68.3° C)
Well done	3 - 4 lbs	325° F (162.8° C)	35	170° F (76.7° C)
LAMB				
Lamb leg	3 - 5 lbs	325° F (162.8° C)	30	180° F (82.2° C)
PORK				
Pork loin	3 - 5 lbs	325° F (162.8° C)	30	180° F (82.2° C)
Pork chops 1" thick	1 - 1 1/4 lbs	325° F (162.8° C)	45 - 50 total time	N/A
Ham, fully cooked	5 lbs	325° F (162.8° C)	15	130° F (54.4° C)
POULTRY				
Chicken, whole	3-4 lbs	350 (176.7° C)	25	180° F (82.2° C)
Turkey, unstuffed	12 - 16 lbs	325° F (162.8° C)	11	180° F (82.2° C)
Turkey	20 - 24 lbs	325° F (162.8° C)	11	180° F (82.2° C)
Turkey, stuffed	12 - 16 lbs	325° F (162.8° C)	9 - 10	180° F (82.2° C)
Turkey, stuffed	20 - 24 lbs	325° F (162.8° C)	9 - 10	180° F (82.2° C)
Turkey breast	4 - 6 lbs	325° F (162.8° C)	20	180° F (82.2° C)

Note: The above information is given as a guide only.

Broiling

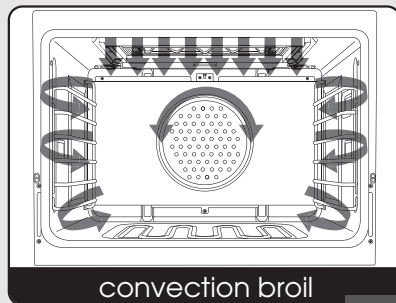

convection broil

CONV BROIL* (Convection Broil)

The top element operates at full power. This function is exactly the same as regular broiling with the additional benefit of air circulation by the motorized fan in the rear of the oven. Smoke is reduced since the airflow also reduces peak temperatures on the

food. Use this setting for broiling thick cuts of meats.

***Note:** This function uses a high-speed convection fan for optimum cooking performance. Some noise may be noticed from this high fan speed. This is normal.

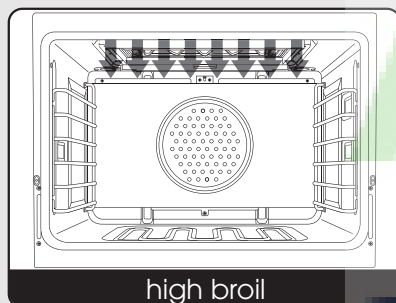

high broil

HI BROIL

Heat radiates from both broil elements, located in the top of the oven cavity, at full power. The distance between the foods and the broil elements determines broiling speed. For fast broiling, food may be as close as 2 inches (5 cm) to the broil element or on the top rack. Fast broiling is best for

meats where rare to medium doneness is desired. Use this setting for broiling small and average cuts of meat.

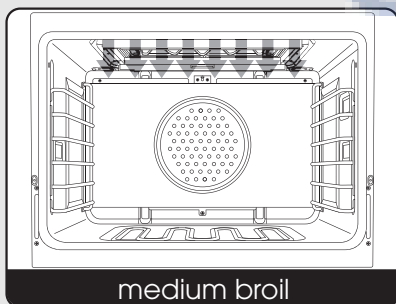

medium broil

MED BROIL

Inner and outer broil elements pulse on and off to produce less heat for slow broiling. Allow about 4 inches (10 cm) between the top surface of the food and the broil element. Slow broiling is best for chicken and ham in order to broil food without over-browning it. Use this setting for broiling small and average cuts of meat.

Broiling

LOW BROIL

This mode uses only a fraction of the available power to the inner broil element for delicate top-browning. The inner broil element is on for only part of the time. Use this setting to gently brown meringue on racks 3 or 4 in 3-4 minutes.

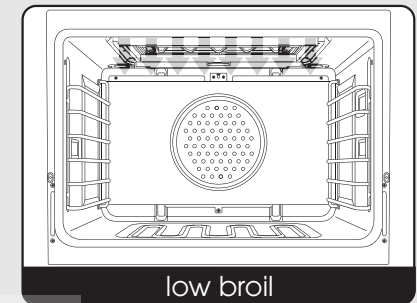

low broil

Broiling Instructions

Broiling is a dry-heat cooking method using direct or radiant heat. It is used for small, individualized cuts such as steaks, chops, and patties. Broiling speed is determined by the distance between the food and the broil element. Choose the rack position based on desired results.

Conventional broiling (LOW, MED or HI BROIL) is most successful for cuts of meat 1-2 inches thick and is also more suitable for flat pieces of meat. Convection broiling has the advantage of broiling food slightly quicker than conventional. Convection broiling of meats produces better results, especially for thick cuts. The meat sears on the outside and retains more juices and natural flavor inside with less shrinkage.

To Use Broil or Convection Broil

1. Arrange the oven rack in the desired position before turning broiler on.
2. Center the food on cold broiler pan and grid supplied with your oven. Place broiler pan in oven.
3. Set the oven function to desired broiling function. Temperature is pre-set to 550°F (290°C), 450°F (230°C), and 350°F (180°C).
4. Close the door. There is not a detent to hold the door in the open broil stop position. With open door broiling, the broil element does not cycle on and off. With closed door broiling, the broil element might cycle on and off if an extended broiling time is required. A built-in smoke "eliminator" in the top of the oven helps reduce smoke and odors.

Broiling

Broiling Tips

- **ALWAYS** use a broiler pan and grid for broiling. They are designed to provide drainage of excess liquid and fat away from the cooking surface to help prevent splatter, smoke, and fire.
- To keep meat from curling, slit fatty edge.
- Brush chicken and fish with butter several times as they broil to prevent drying out. To prevent sticking, lightly grease broiler tray.
- Broil on first side for slightly more than half the recommended time, season, and turn. Season second side just before removing.
- **ALWAYS** pull rack out to stop position before turning or removing food.
- Use tongs or a spatula to turn meats. **NEVER** pierce meat with a fork, as this allows the juices to escape.
- Remove the broiler pan from the oven when you remove the food. Drippings will bake onto the pan if it is left in the heated oven after broiling. While pan is hot, place damp paper towel over grid. Drizzle with liquid dishwashing detergent and pour water over grid. This will make cleaning of the pan easier, or the broiler pan can be lined with aluminum foil to make cleaning easier. Be sure the foil extends up the side of the pan. Although it is not recommended, the grid can also be covered with foil. Be sure to slit openings to conform with the openings in the grid so melted fat can drain through to prevent spattering, smoking, or the possibility of grease fire.

Rack Positions for Broiling

Note: Position 6 is the closest to the broiler and position 1 is the closest to the oven bottom.

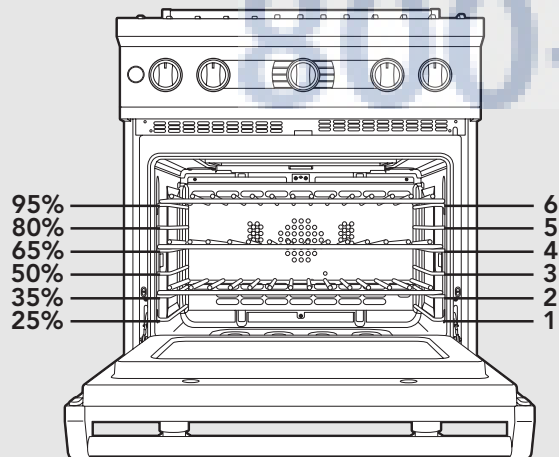

Broiling

Broiling Chart

Type and Cut of Meat	Weight	Setting	Rack	Time (min)
BEEF				
Sirloin, 1"				
Rare	12 oz	Conventional Broil	5	7
Medium	12 oz	Conventional Broil	5	9
Well done	12 oz	Conventional Broil	5	11
T-Bone, 3/4"				
Rare	10 oz	Conventional Broil	5	5
Medium	10 oz	Conventional Broil	5	7
Well done	10 oz	Conventional Broil	5	9
Hamburger, 1/2"				
Rare	1/4 lb.	Convection Broil	5	4
Medium	1/4 lb.	Convection Broil	5	7
Well done	1/4 lb.	Convection Broil	5	9
CHICKEN				
Bnls breast	1 lb.	Convection Broil	4	18
Bone-in breast	2 - 2 1/2 lb.	Conventional Broil	4	20
Chicken pieces	2 - 2 1/2 lb.	Convection Broil	4	18 (min/lb)
HAM				
Ham slice, 1"	1 lb.	Conventional Broil	4	22
LAMB				
Rib chops, 1"	12 oz.	Convection Broil	5	7
Shoulder	1 lb.	Convection Broil	5	6
PORK				
Loin chops, 3/4"	1 lb.	Convection Broil	4	14
Bacon		Conventional Broil	4	6
FISH				
Salmon steak	1 lb.	Convection Broil	5	7
Fillet	1 lb.	Convection Broil	5	6

Note: The above information is given as a guide only.

Convection Dehydrate/Defrost

Convection Dehydrate

This oven is designed not only to cook, but also to dehydrate fruits and vegetables by removing water through evaporation.

1. Prepare the food as recommended.
2. Arrange the food on drying racks (not included with the oven; contact a local store handling speciality cooking utensils).
3. Press "OVEN FUNCTION" button, toggle to TRU CONV DEHYDRATE setting, and push "SELECTOR" in to accept.

⚠ CAUTION

You must carefully check the food during the dehydration process to ensure that it does not catch fire.

Defrost

1. Place the frozen food on a baking sheet.
2. Press "OVEN FUNCTION" button, toggle to TRU CONV DEFROST setting, and push "SELECTOR" in to accept.

⚠ WARNING

To avoid sickness and food waste, **DO NOT** allow defrosted food to remain in the oven for more than two hours.

⚠ NOTICE

DO NOT use the Oven Temperature Function during defrosting. Turning the convection fan on will accelerate the natural defrosting of the food without the heat.

User Settings

To adjust settings:

1. Press "CLEAR" and hold 2 seconds to activate.
2. Toggle "SELECTOR" right or left to desired setting.
3. When desired setting is flashing, push "SELECTOR" to change value.
4. When done with adjustments, toggle to "EXIT". Push "SELECTOR" or choose "OFF" to exit.

Settings

- F° or C°
- 12/24hr
- Sabbath
- Brightness
- Showroom
- Exit

Options

Select temperature format. Default is °F.
 Select time format. Default is 12hr.
 Default is "OFF".
 Select levels from 1-5 with 5 being the brightest.
 Default is 5.
 Disables heating elements.
 Final step in user settings. From this step, exit from User Settings (press on "SELECTOR") or go to Advanced Settings

Sabbath Mode

This mode offers users belonging to religions with "no work" restrictions to program their ovens to comply with the Sabbath requirement. When oven door is opened in Sabbath mode, the oven light stays off while the convection fan and heating elements remain on.

Showroom Mode

This mode allows the oven to be hooked up to a 120 volt electrical supply for display or showroom mode purposes. In this mode, electronic display/controls and oven lights will function but heating elements and convection fan will **NOT** function.

Meat Probe

The meat probe takes the guesswork out of roasting by cooking foods to the ideal internal temperature. The probe setting is used to automatically turn the oven off when meat reaches its optimal internal temperature. Your Viking oven's built-in probe will help you prepare meats exactly as you want them.

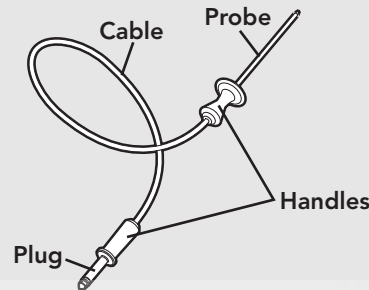

To Insert the Meat Probe:

After preparing the meat and placing it on the broiler pan, follow these steps for proper probe placement:

1. Plug meat probe into the receptacle in the oven cavity wall. *If probe is not plugged into the oven wall cavity, "CLOCK/PROBE" button will not function as a "Probe" activator.*
2. Lay the probe on the outside of the meat along the top or side and use your finger to mark where the edge of the meat meets the probe. The point where they meet should rest in the center of the thickest, meatiest part of the roast.
3. Insert the probe completely into the meat. It should not touch the bone, fat, or gristle.
 - For roasts with no bone, insert the probe into the meatiest part of the roast.
 - For bone-in ham or lamb, insert the probe into the center of the lowest large muscle or joint.
 - With a whole turkey, insert the probe into the meatiest part of the inner thigh from below and parallel to the leg.



4. Press "CLOCK/PROBE" button to activate. Right display will read Meat Probe Set Point. See "Temperature Range and Default" chart on page 25. "Probe" will illuminate under left display.

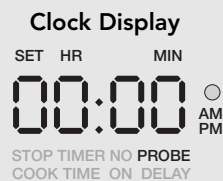

Meat Probe

To Insert the Meat Probe (cont.)

5. Toggle "SELECTOR" right to increase or left to decrease to desired temperature in 1°F increments.
6. Push in "SELECTOR" to accept time or after 5 seconds, probe time will auto-accept.
7. Set OVEN FUNCTION and TEMPERATURE as detailed in "Set Oven Function and Temperature" on page 23.

(Meat probe will display actual internal meat temperature as it cooks. When programmed "Probe Temperature" is achieved, there will be 3 long "beeps" and right display alternates between FUNCTION/Set Point and DONE/Meat Set Point. On left display, PROBE icon flashes. Oven will automatically turn off. The control emits a short reminder beep every 60 seconds until the "OFF" or CLEAR/SETTINGS button is pressed.)

Note: DELAY COOK cannot be performed in conjunction with a COOK BY PROBE operation as DELAY COOK has no Start Time programmed in.

Note: TIMED COOK can be performed along with a MEAT PROBE, but only when Meat Probe is used for monitoring only.

Meat Probe Use and Care

- Use of probes other than the one provided with your oven may result in damage to the probe.
- Use the handles of the probe and plug when inserting and removing them from the meat and outlet.
- To avoid damaging your probe, **NEVER** use tongs to pull on the cable when removing.
- To avoid breaking the probe, make sure food is completely defrosted before inserting.
- To prevent possible burns, **DO NOT** unplug the probe from the outlet until the oven has cooled.
- **NEVER** leave the probe inside the oven during a self-cleaning cycle.
- **NEVER** store the probe inside the oven.

Cleaning and Maintenance

Any piece of equipment works better and lasts longer when maintained properly and kept clean. Cooking equipment is no exception. Your range must be kept clean and maintained properly. Before cleaning, make sure all controls are in the "OFF" position. Disconnect power if you are going to clean thoroughly with water.

Surface Burners

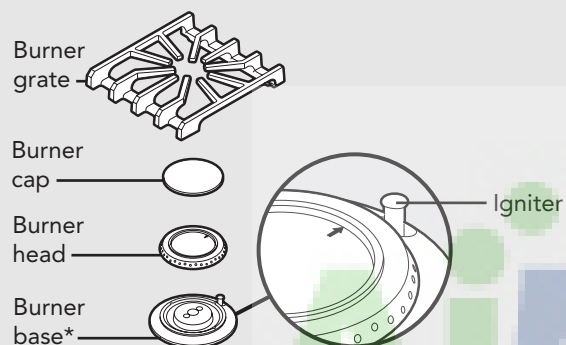

* **Note:** When replacing burner head, arrow must be pointing towards back of range.

Wipe up spill-overs as soon as possible after they occur and before they get a chance to burn in and cook solid. In the event of a spill-over, follow these steps:

- Allow the burner and grate to cool to a safe temperature level.
- Lift off the burner grate. Wash in warm soapy water.
- Remove the burner cap and burner head and clean.

Burner Caps

The surface burner caps should be routinely removed and cleaned. **ALWAYS** clean the burner caps after a spill-over. Keeping the burner caps clean will prevent improper ignition and uneven flames. To clean, pull burner cap straight up from the burner base. Wipe off surface burner caps with warm, soapy water and a soft cloth after each use. Use a non-abrasive cleanser such as Bon Ami™ and a soft brush or soft Scotch Brite™ pad for cooked-on foods. Dry thoroughly after cleaning. For best cleaning and to avoid possible rusting, **DO NOT** clean in dishwasher or self-cleaning oven.

Cleaning and Maintenance

Burner Head

If ports on burner head are clogged, clean with a straight pin. **DO NOT** enlarge or distort the ports. **DO NOT** use a toothpick to clean the ports. When replacing burner head, carefully align the 2 tabs underneath the burner head with the outside edge of burner base. Make sure the tabs are not aligned with the igniter and the burner cap is level.

Note: For stubborn stains, use a non abrasive cleanser such as Bon Ami™ and a soft brush or soft Scotch Brite™ pad.

Cleaning Tip: For difficult to clean burner caps and heads, place parts in a zip seal bag with ammonia.

Burner Base

The base should be wiped regularly with hot soapy water at the end of each cooling period. **DO NOT** use steel wool, abrasive cloths, cleanser, or powders. To remove encrusted materials, soak the area with a hot towel to loosen the material, then use a wooden nylon spatula. **DO NOT** use a metal knife, spatula, or any other metal tool to scrape the aluminum base.

- Wipe up any spills which remain on the sealed top surface.
- Replace burner cap, burner head, and grates after drying thoroughly.

Control Panel

DO NOT use any cleaners containing ammonia or abrasives. They could remove the graphics from the control panel. Use hot, soapy water and a soft clean cloth.

Oven Surfaces

Several different finishes have been used in your oven. Your oven features a self-clean cycle for the oven interior. See the "Self-Clean Cycle" section for complete instructions. **NEVER** USE AMMONIA, STEEL WOOL PADS OR ABRASIVE CLOTHS, CLEANSERS, OVEN CLEANERS, OR ABRASIVE POWDERS. THEY CAN PERMANENTLY DAMAGE YOUR OVEN.

Cleaning and Maintenance

Control Knobs

MAKE SURE ALL THE CONTROL KNOBS POINT TO THE OFF POSITION BEFORE REMOVING. Pull the knobs straight off. Wash in detergent and warm water. Dry completely and replace by pushing firmly onto stem.

Stainless Steel Parts

All stainless steel body parts should be wiped regularly with hot soapy water at the end of each cooling period and with a liquid cleaner designed for that material when soapy water will not do the job.

DO NOT use steel wool, abrasive cloths, cleansers, or powders. If necessary, scrape stainless steel to remove encrusted materials, soak the area with hot towels to loosen the material, then use a wooden or nylon spatula or scraper. **DO NOT** use a metal knife, spatula, or any other metal tool to scrape stainless steel. **DO NOT** permit citrus or tomato juice to remain on stainless steel surface, as citric acid will permanently discolor stainless steel. Wipe up any spills immediately.

Broiler Pan and Grid

Clean with detergent and hot water. For stubborn spots, use a soap-filled steel wool pad.

Oven Racks

Clean with detergent and hot water. Stubborn spots can be scoured with a soap-filled steel wool pad. **DO NOT** CLEAN THE OVEN RACKS USING THE SELF-CLEAN CYCLE. They could sustain damage due to the extreme heat of the Self-Clean cycle.

Power Failure

If power failure occurs, the electric igniters will not work. No attempt should be made to operate the appliance during a power failure. Make sure the oven control is in the "OFF" position.

Momentary power failure can occur unnoticed. The range is affected only when the power is interrupted. When it comes back on, the range will function properly without any adjustments. A "brown-out" may or may not affect range operation, depending on how severe the power loss is. If the range is in the self-clean cycle when the power failure occurs, wait until power is restored and allow door to unlock automatically. Turn all controls "OFF" and restart self-clean cycle again, according to instructions.

Cleaning and Maintenance

⚠ WARNING

POWER FAILURE WARNING

Due to safety considerations and the possibility of personal injury in attempting to light and extinguish the burner, the grill should, not under any circumstances, be used during a power failure. The grill burner control should always remain in the "OFF" position during a power failure.

Self-Clean Cycle

This oven features an automatic pyrolytic self-cleaning cycle. During this cycle, the oven reaches elevated temperatures in order to burn-off soil and deposits. An integral smoke eliminator helps reduce odors associated with the soil burn-off. A powder ash residue is left in the bottom of the oven after completion of the self-clean cycle. The door latch is automatically activated after selecting the self-clean setting. The latch ensures that the door cannot be opened while the oven interior is at clean temperatures.

Before starting the Self-Clean cycle:

1. Remove the oven racks, and any other items/utensils from the oven. The high heat generated during the cleaning cycle can discolor, warp, and damage these items. **DO NOT** use foil or liners in the oven. During the self-clean cycle, foil can burn or melt and damage the oven surface.
2. Wipe off any large spills from the oven bottom and sides. **NEVER** use oven cleaners inside a self-cleaning oven or on raised portions of the door.
3. Some areas of the oven must be cleaned by hand before the cycle begins. Soils in these areas will be baked on and very difficult to clean if not removed first. Clean the door up to the gasket, the door frame, and up to 2 inches inside the frame with detergent and hot water. Rinse thoroughly and dry.

Self-Clean Cycle

If Self-Clean is selected:

Note: A fan noise will be heard during the self-clean cycle and will continue to run for the 3-1/2 hour duration of the self-clean cycle.

1. The control initiates the door lock. During this period, the display shows "LOCKING".
2. Once the door is locked, the control displays SELF CLEAN and the time remaining on the display.
3. The control continues in SELF CLEAN mode for the required SELF CLEAN duration.
4. Once the SELF CLEAN cycle is complete, the control displays "COOLDOWN". The door remains locked.
5. When 500°F is reached, the control unlocks the door and "COOLDOWN" is no longer displayed.

⚠ WARNING

BURN OR ELECTRICAL SHOCK HAZARD

Make sure all controls are "OFF" and oven is COOL before cleaning. Failure to do so can result in burns or electrical shock.

⚠ CAUTION

DO NOT touch the exterior portions of the oven after self-cleaning cycle has begun, since some parts become extremely hot to the touch! During the first few times the self-cleaning feature is used, there may be some odor and smoking from the curing of the binder in the high-density insulation used in the oven. When the insulation is thoroughly cured, this odor will disappear. During subsequent self-cleaning cycles, you may sense an odor characteristic of high temperatures. Keep the kitchen well-vented during the self-cleaning cycle.

Replacing Oven Lights

⚠ WARNING



ELECTRICAL SHOCK HAZARD

Disconnect the electric power at the main fuse or circuit breaker before replacing bulb.

⚠ WARNING

DO NOT touch bulb with bare hands. Clean off any signs of oil from the bulb and handle with a soft cloth.

1. Unsnap glass light cover using a screwdriver in the access groove.
2. Firmly grasp light bulb and pull out.
3. Replace with halogen bulb using volt and wattage requirements listed on glass cover.
4. Replace the light cover by snapping glass cover onto metal box.
5. Reconnect power at the main fuse or circuit breaker.

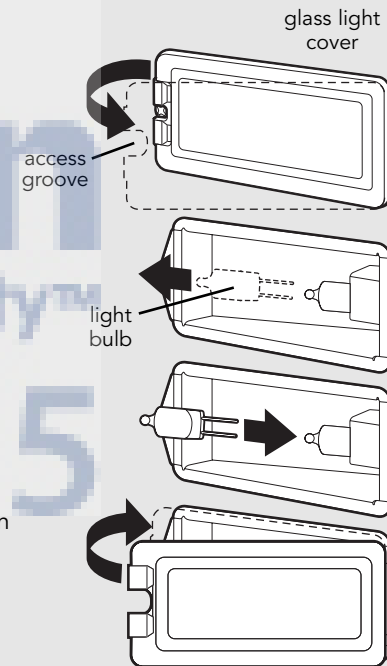

Troubleshooting

Problem	Possible Cause and/or Remedy
Range will not function.	Range is not connected to electrical power. Have electrician check power circuit breaker, wiring, and fuses. Range is in SHOWROOM mode.
Oven does not operate in self-clean.	Door is not shut tight enough for automatic door latch to lock.
Door will not open.	Oven is still in self-clean mode. If oven is hot, door latch will release when safe temperature is reached.
Oven light will not work.	Light bulb is burned out. Range is not connected to power.
Igniters will not work.	Circuit is tripped. Fuse is blown. Range is not connected to power.
Igniters sparking but no flame ignition.	Gas supply valve is in "OFF" position. Gas supply is interrupted.
Igniters sparking continuously after flame ignition.	Power supply is not grounded. Power supply polarity is reversed. Igniters are wet or dirty.
Burner ignites but flame is large, distorted, or yellow.	Burner ports are clogged. Unit is being operated on wrong type of gas. Air shutters not properly adjusted.

Note: This range is equipped with a feature that can detect and report any internal errors. If you see an error code on the display, please call Viking Customer Service at 1-888-VIKING1 (845-4641).

Service Information

If service is required, call your dealer or authorized service agency. The name of the authorized service agency can be obtained from the dealer or distributor in your area.

Have the following information readily available.

- Model number
- Serial number
- Date purchased
- Name of dealer from whom purchased

Clearly describe the problem that you are having. If you are unable to obtain the name of an authorized service agency, or if you continue to have service problems, contact Viking Range Corporation at 1-888-VIKING1 (845-4641), or write to:

**VIKING RANGE CORPORATION
PREFERRED SERVICE
1803 Hwy 82W
Greenwood, Mississippi 38930 USA**

Record the information indicated below. You will need it if service is ever required.

The model and serial number for your range can be found by opening door and looking under the control panel.

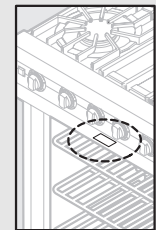

Model no. _____ Serial no. _____

Date of purchase _____ Date installed _____

Dealer's name _____

Address _____

If service requires installation of parts, use only authorized parts to insure protection under the warranty.

Keep this manual for future reference.

Warranty

PROFESSIONAL SERIES CUSTOM FREESTANDING ELECTRONIC CONTROL DUAL FUEL RANGES WARRANTY

THREE YEAR FULL WARRANTY

Freestanding electronic control dual fuel ranges and all of their component parts, **except as detailed below***†, are warranted to be free from defective materials or workmanship in normal residential use for a period of three (3) years from the date of original retail purchase or closing date for new construction, whichever period is longer. Viking Range Corporation, warrantor, agrees to repair or replace, at its option, any part which fails or is found to be defective during the warranty period.

***FULL NINETY (90) DAY COSMETIC WARRANTY:** Product is warranted to be free from cosmetic defects in materials or workmanship (such as scratches on stainless steel, paint/porcelain blemishes, etc.) for a period of ninety (90) days from the date of original retail purchase or closing date for new construction, whichever period is longer. Any defects must be reported to the selling dealer within ninety (90) days from date of original retail purchase. Viking Range Corporation uses high quality processes and materials available to produce all color finishes. However, slight color variation may be noticed because of the inherent differences in painted parts and porcelain parts as well as differences in kitchen lighting, product locations, and other factors. Therefore, this warranty does not apply to color variation attributable to such factors.

†FULL NINETY (90) DAY WARRANTY IN "RESIDENTIAL PLUS" APPLICATIONS: This full warranty applies to applications where use of the product extends beyond normal residential use, but the warranty period for products used in such applications is ninety (90) days. Examples of applications covered by this warranty are bed and breakfasts, fire stations, private clubs, churches, yachts, etc. Under this "Residential Plus" warranty, the product, its components and accessories are warranted to be free from defective material or workmanship for a period of ninety (90) days from the date of original retail purchase. This warranty excludes use of the product in all commercial locations such as restaurants, food service locations and institutional food service locations.

FIVE YEAR LIMITED WARRANTY ON BURNERS

Any surface burner, griddle burner, grill burner, or oven burner which fails due to defective materials or workmanship (excluding cosmetic failures) in normal household use during the fourth through fifth year from the date of original retail purchase will be repaired or replaced, free of charge for the part itself, with the owner paying all other costs, including labor. This does not include ignition systems, burner bases, etc.

TEN YEAR LIMITED WARRANTY ON PORCELAIN

Any porcelain oven or porcelain inner door panel which rusts through due to defective materials or workmanship in normal household use during the fourth through the tenth year from the date of original retail purchase will be repaired or replaced, free of charge for the part itself, with the owner paying all other costs, including labor.

TERMS AND CONDITIONS

This warranty extends to the original purchaser of the product warranted hereunder and to each transferee owner of the product during the term of the warranty and applies to products purchased and located in the United States and Canada. Products must be purchased in the country where service is requested. If the product or one of its component parts contains a defect or malfunction during the full warranty period after a reasonable number of attempts by the warrantor to remedy the defect or malfunction, the owner is entitled to either a refund or replacement of the product or its component part or parts. Replacement of a component part includes its free installation, except as specified under the limited warranty. Under the terms of this warranty, service must be performed by a factory authorized Viking Range Corporation service agent or representative. Service will be provided during normal business hours, and labor performed at overtime or premium rates shall not be covered by this warranty.

Owner shall be responsible for proper installation, providing reasonable and necessary maintenance, providing proof of purchase upon request, and making the appliance reasonably accessible for service. The return of the Owner Registration Card is not a condition of warranty coverage. You should, however, return the Owner Registration Card so that Viking Range Corporation can contact you should any question of safety arise which could affect you.

This warranty gives you specific legal rights, and you may also have other rights which may vary from jurisdiction to jurisdiction.

WHAT IS NOT COVERED BY THIS WARRANTY: This warranty shall not apply to damage resulting from abuse, failure to provide reasonable and necessary maintenance, accident, delivery, negligence, natural disaster, loss of electrical power to the product for any reason, alteration, outdoor use, improper installation, improper operation, or repair or service of the product by anyone other than an authorized Viking Range Corporation service agency or representative. This warranty does not apply to commercial usage.

Warranty (cont.)

LIMITATION OF REMEDIES AND DURATION OF IMPLIED WARRANTY
OWNER'S SOLE AND EXCLUSIVE REMEDY FOR A CLAIM OF ANY KIND WITH RESPECT TO THIS PRODUCT SHALL BE THE REMEDIES SET FORTH ABOVE. VIKING IS NOT RESPONSIBLE FOR CONSEQUENTIAL OR INCIDENTAL DAMAGE, INCLUDING BUT NOT LIMITED TO FOOD OR MEDICINE LOSS, DUE TO PRODUCT FAILURE, WHETHER ARISING OUT OF BREACH OF WARRANTY, BREACH OF CONTRACT OR OTHERWISE. Some jurisdictions do not allow the exclusion or limitation of incidental or consequential damages, so the above limitation or exclusions may not apply to you. **ANY IMPLIED WARRANTIES OF MERCHANTABILITY OR FITNESS FOR A PARTICULAR PURPOSE APPLICABLE TO THIS PRODUCT ARE LIMITED IN DURATION TO THE PERIOD OF COVERAGE OF THE APPLICABLE EXPRESS WRITTEN LIMITED WARRANTIES SET FORTH ABOVE.** Some states do not allow limitations on how long an implied warranty lasts, so the above limitation may not apply to you.

WARRANTY SERVICE

To obtain warranty service, contact an authorized Viking Range Corporation service agent, or Viking Range Corporation, 111 Front Street, Greenwood, Mississippi 38930, (888) 845-4641. Provide model and serial number and date of original purchase or closing date for a new construction. For the name of your nearest authorized Viking Range Corporation service agency, call Viking Range Corporation. **IMPORTANT:** Retain proof of original purchase to establish warranty period.

Specifications subject to change without notice.

