



2023 F.O.B. PRICE LIST

EFFECTIVE APRIL 1, 2023

These F.O.B. prices (in United States dollars) are effective April 1, 2023, and apply to the sale of any WEBER brand products by Weber to an authorized retailer ("Dealers") and supersede any previous F.O.B. prices. All F.O.B. prices are subject to change by Weber for any reason with thirty (30) days written notice. Weber reserves the right to refuse to sell any products or extend credit for any reason. Weber requires that Dealers resell WEBER products only to consumers at Dealer's retail location(s) within the United States. As a condition of sale, Weber (i) prohibits any sales by a Dealer of WEBER products on Internet auction sites, such as eBay® or Craigslist; (ii) prohibits trans-shipping of products between Dealers (or unauthorized retailers) or to locations outside of the 48 contiguous United States; and (iii) prohibits Dealer gas conversion of stock, floor or inventory units. Consumer inquiries regarding connection to bulk propane should be directed to the attention of Weber's Customer Service 1-800-446-1071. Any breach of these conditions of sale or the Weber Terms & Conditions may result in the termination of buying privileges and other remedies, for which Weber reserves all rights. See Weber's published policies relating to sale of Weber products on auction sites, trans-shipping and gas conversion for additional details.

Terms: The Terms and Conditions on Dealer's Credit Application apply to all of Dealer's purchases for Weber.

F.O.B. point: Any Weber warehouse (or at Dealer's request, Dealer's warehouse).

Note: Dealer is responsible for any transportation risks including the filing, if necessary, of any claims for loss or damage.

Minimum order value is \$500.00. Minimum order quantity is one master carton.

Although Weber may suggest retail prices, Dealers are free to determine the prices at which they will sell Weber products.

Note: WEBER gas grills sold to dealers in the United States have been tested and certified for use within the United States only; these grills have not been tested and certified for outside the United States. WEBER gas grills may not be exported to retailers and/or individuals living outside the United States. Gas mixtures, gas pressures, regulators, fittings and gas cylinders are different from country to country. Gas grills certified to U.S. standards may not be legal to operate outside of the United States. Use or shipment outside of the U.S. will void the limited-warranty covering any grill. If you become aware that a consumer is buying a WEBER gas grill with the intention of shipping it out of the United States, you should refuse the sale. Please direct any inquiries from consumers intending to use or ship a WEBER gas grill outside of the U.S., to Weber Customer Service 1-800-446-1071.

WARRANTY 01

GAS GRIDDLES

WEBER GRIDDLE 02

PELLET GRILLS

SMOKEFIRE 03

ELECTRIC GRILLS

LUMIN 05

Q 07

PULSE 08

GAS GRILLS

WEBER TRAVELER 09

Q 10

SPIRIT II AND SPIRIT 13

GENESIS 18

SUMMIT 30

PORTABLE GRILLS

SMOKEY JOE 34

GO-ANYWHERE 35

CHARCOAL GRILLS

ORIGINAL KETTLE 36

MASTER-TOUCH 39

PERFORMER 40

SUMMIT KAMADO 42

SMOKERS 43

RANCH KETTLE 43

ACCESSORIES

SMART ASSISTANTS 44

COOKING 46

PREP AND SERVE 62

CARE 67

MERCHANDISE 84

HOW WE MEASURE 88

WEBER REPRESENTATIVES 89

INDEX 91



WARRANTY



2022 GENESIS GAS GRILLS

- 12 years** Cookbox: no rust-through/burn-through (2 years on paint excluding fading or discoloration)
- 12 years** Lid assembly: no rust-through/burn-through (2 years on paint excluding fading or discoloration)
- 10 years** Stainless steel burner tubes: no rust-through/burn-through
- 10 years** Stainless steel cooking grates: no rust-through/burn-through
- 10 years** Stainless steel Flavorizer® bars: no rust-through/burn-through
- 10 years** Porcelain-enameled cast-iron cooking grates: no rust-through/burn-through
- 3 years** Electrical components (Weber Connect controller)
- 5 years** All remaining parts



SPIRIT II, GENESIS II*, AND SUMMIT GAS GRILLS

- 10 years** All components from the date of purchase when assembled and operated in accordance with the accompanying Owner's Manual, normal wear and tear excluded.
- *3 years** Electrical components (Weber Connect® controller)



SPIRIT GAS GRILL

- 10 years** Cookbox: no rust-through/burn-through (2 years on paint excluding fading or discoloration)
- 10 years** Lid assembly: no rust-through/burn-through (2 years on paint excluding fading or discoloration)
- 10 years** Stainless steel burner tubes: no rust-through/burn-through
- 5 years** Stainless steel cooking grates: no rust-through/burn-through
- 5 years** Stainless steel Flavorizer® bars: no rust-through/burn-through
- 5 years** Porcelain-enameled cast-iron cooking grates: no rust-through/burn-through
- 3 years** Electrical components (Weber Connect® controller)
- 2 years** All remaining parts

GO-ANYWHERE GAS GRILL

- 10 years** Cookbox: no rust-through/burn-through
- 10 years** Lid assembly: no rust-through/burn-through
- 5 years** Plastic components (excludes fading or discoloration)
- 2 years** All remaining parts

SUMMIT KAMADO

- 10 years** Bowl, lid, and center ring: no rust-through/burn-through
- 5 years** Stainless steel cooking grates: no rust-through/burn-through
- 5 years** One-Touch™ cleaning system: no rust-through/burn-through
- 5 years** Plastic components (excludes fading or discoloration)
- 2 years** All remaining parts

CHARCOAL GRILLS AND SMOKERS

- 10 years** Bowl, lid, and center ring: no rust-through/burn-through
- 5 years** One-Touch™ cleaning system: no rust-through/burn-through
- 5 years** Plastic components (excludes fading or discoloration)
- 2 years** All remaining parts



SMOKEFIRE WOOD FIRED PELLET GRILL

- 5 years** Cook box and all components not covered below
- 3 years** Electrical components (Weber Connect® controller, auger motor, fan, probes)
- 3 years** Cooking grates, pellet slide, burn pot, heat baffle, pellet grate, controller bezel

WEBER TRAVELER GAS GRILL

- 5 years** Cookbox: no rust-through/burn-through
- 5 years** Lid assembly: no rust-through/burn-through
- 3 years** Stainless steel burner tube: no rust-through/burn-through
- 3 years** Porcelain-enameled cast-iron cooking grates: no rust-through/burn-through
- 2 years** All remaining parts

WEBER LUMIN, LUMIN COMPACT ELECTRIC GRILLS AND WEBER Q SERIES: 1000, 2000, & 3000

- 5 years** Cookbox: no rust-through/burn-through (2 years on paint excluding fading or discoloration)
- 5 years** Lid assembly: no rust-through/burn-through (2 years on paint excluding fading or discoloration)
- 5 years** Stainless steel burner tubes: no rust-through/burn-through
- 5 years** Porcelain-enameled cast-iron cooking grates: no rust-through/burn-through
- 5 years** Plastic components (excluding fading or discoloration)
- 2 years** All remaining parts

WEBER GRIDDLE GAS GRILL

- 5 years** Cookbox: no rust-through/burn-through (2 years on paint excluding fading or discoloration)
- 5 years** Hard cover assembly: no rust-through/burn-through (2 years on paint excluding fading or discoloration)
- 5 years** Stainless steel burner tubes: no rust-through/burn-through
- 5 years** Carbon Steel Cooktop: (excluding rust)
- 5 years** All remaining parts: (excluding normal wear and tear)

GAS GRIDDLES

FOB

MAP

MSRP

WEBER GRIDDLE G28 GAS GRILL

43310201

\$299.25

\$449.00

\$549.00

WEBER GRIDDLE G28 GAS GRILL

BLACK

LP

MASTER CARTON: 1

H: 33.5 W: 25.35 D: 17.52 Wt: 111.95 Cu.Ft.: 8.6

DIMENSIONS - LID CLOSED

H: 37.79 W: 53.55 D: 23.56

DIMENSIONS - LID OPEN

H: 41.5 W: 53.5 D: 23.9



0 77924 19704 8

NEW



- Primary cooking area: 504 sq. in
- Three stainless steel burners
- 36,000 BTU-per-hour input burners
- **SNAP-JET** individual burner ignition system
- Hot-rolled steel cooktop
- Aluminized steel cookbox
- Side table area: 410 sq. in
- Four Tool hooks
- Front access, high capacity pull out grease tray
- Two large wheels
- Open cart design
- Hard cover with handle and two hanging hooks
- Liquid Propane (LP)

WEBER GRIDDLE G36 GAS GRILL

44310401

\$416.90

\$579.00

\$679.00

WEBER GRIDDLE G36 GAS GRILL

BLACK

LP

MASTER CARTON: 1

H: 40.55 W: 27.4 D: 17.32 Wt: 154 Cu.Ft.: 11.1

DIMENSIONS - LID CLOSED

H: 37.23 W: 61.04 D: 25.85

DIMENSIONS - LID OPEN

H: 47.66 W: 61.04 D: 28.4



0 77924 19924 0

NEW



- Primary cooking area: 756 sq. in
- Four stainless steel burners
- 60,000 BTU-per-hour input burners
- **SNAP-JET** individual burner ignition system
- Hot-rolled steel cooktop
- Aluminized steel cookbox
- Side table area: 488 sq. in
- Four Tool hooks
- Front access, high capacity pull out grease tray
- Two front locking casters/two back swivel casters
- Open cart design
- Hinged hard cover
- Liquid Propane (LP)

FOB

MAP

MSRP

SMOKEFIRE SEAR+ ELX4 PELLET GRILL

22722001 **\$979.30** \$1,399.00 \$1,599.00

SMOKEFIRE SEAR+ ELX4 PELLET GRILL BLACK

MASTER CARTON: 1

H: 31.25 **W:** 43.5 **D:** 30.25 **Wt:** 176.0 **Cu.Ft.:** 23.8

DIMENSIONS - LID CLOSED

H: 47.0 **W:** 43.5 **D:** 33.0

DIMENSIONS - LID OPEN

H: 64.4 **W:** 51.2 **D:** 32.7



0 77924 19705 5

NEW



- Dual grilling space = 771 sq in
- Bottom grate 432 sq in, Top grate 339 sq in
- 200°-600°F temperature range
- SmokeBoost
- **WEBER CONNECT** smart grilling technology:
 - Step-by-step grilling assistance
 - Flip & serve notifications
 - Remote Grill Control and Monitoring
 - Remote Grill Shut Down
 - Diagnostic Alerts
- LCD display
- **NIGHTVISION** surface lighting
- **WEBER CRAFTED** Outdoor Kitchen Collection frame
- **WEBER CRAFTED** Outdoor Kitchen Collection sear grate
- Extra-large folding top rack
- Illuminated control knob
- Top rack grate hooks
- Large black side table with tool hooks and grate hooks
- Includes two meat probes, four probe capacity
- Porcelain-enameled lid and cookbox
- Stainless steel **FLAVORIZER** bars
- High capacity hopper
- Low Fuel Sensor
- Plated steel cooking grates
- Large black side table with tool hooks
- Porcelain-enamel heat distribution plate
- Includes two glow plugs
- Heavy-duty steel cart frame
- Premium four swivel casters (2 locking, 2 non-locking)

SMOKEFIRE SEAR+ ELX6 PELLET GRILL

23722001 **\$1,119.30** \$1,599.00 \$1849.00

SMOKEFIRE SEAR+ ELX6 PELLET GRILL BLACK

MASTER CARTON: 1

H: 31.25 **W:** 55.5 **D:** 30.25 **Wt:** 204.0 **Cu.Ft.:** 30.4

DIMENSIONS - LID CLOSED

H: 47.0 **W:** 55.5 **D:** 33.0

DIMENSIONS - LID OPEN

H: 64.4 **W:** 63.2 **D:** 32.7



0 77924 19706 2

NEW



- Dual grilling space, main cooking area = 1,156 sq in
- Bottom grate 648 sq in, Top grate 508 sq in
- 200°-600°F temperature range
- SmokeBoost
- **WEBER CONNECT** smart grilling technology:
 - Step-by-step grilling assistance
 - Flip & serve notifications
 - Remote Grill Control and Monitoring
 - Remote Grill Shut Down
 - Diagnostic Alerts
- LCD display
- **NIGHTVISION** surface lighting
- **WEBER CRAFTED** Outdoor Kitchen Collection frame
- **WEBER CRAFTED** Outdoor Kitchen Collection sear grate
- Extra-large folding top rack
- Illuminated control knob
- Top rack grate hooks
- Large black side table with tool hooks and grate hooks
- Includes two meat probes, four probe capacity
- Porcelain-enameled lid and cookbox
- Stainless steel **FLAVORIZER** bars
- High capacity hopper
- Low Fuel Sensor
- Plated steel cooking grates
- Large black side table with tool hooks
- Porcelain-enamel heat distribution plate
- Includes two glow plugs
- Heavy-duty steel cart frame
- Premium four swivel casters (2 locking, 2 non-locking)

PELLET GRILLS

FOB

MAP

MSRP

SMOKEFIRE EX4 WOOD FIRED PELLET GRILL (2ND GEN)

22510201

\$769.84

\$1,099.00

\$1,299.00

SMOKEFIRE EX4 WOOD PELLET GRILL

BLACK

MASTER CARTON: 1

H: 31.3 W: 43.5 D: 30.3 Wt: 176.0 Cu.Ft.: 23.8

DIMENSIONS - LID CLOSED

H: 47.0 W: 43.0 D: 33.0

DIMENSIONS - LID OPEN

H: 62.0 W: 43.0 D: 33.0



- Dual grilling space = 672 sq in
- Bottom grate 432 sq in, Top grate 240 sq in
- 200°-600°F temperature range
- SmokeBoost
- **WEBER CONNECT** smart grilling technology:
 - Step-by-step grilling assistance
 - Flip & serve notifications
 - Remote Grill Control and Monitoring
 - Remote Grill Shut Down
 - Diagnostic Alerts
- LCD display
- Includes two meat probes, four probe capacity
- Porcelain-enameled lid and cookbox
- Stainless steel **FLAVORIZER** bars
- High capacity hopper
- Low Fuel Sensor
- Plated steel cooking grates
- Large stainless steel side table with tool hooks
- Porcelain-enamel heat distribution plate
- Includes two glow plugs
- Heavy-duty steel cart frame
- Four swivel casters (2 locking, 2 non-locking)

SMOKEFIRE EX6 WOOD FIRED PELLET GRILL (2ND GEN)

23510201

\$909.82

\$1,299.00

\$1,499.00

SMOKEFIRE EX6 WOOD PELLET GRILL

BLACK

MASTER CARTON: 1

H: 31.3 W: 55.5 D: 30.3 Wt: 204.0 Cu.Ft.: 30.4

DIMENSIONS - LID CLOSED

H: 47.0 W: 55.0 D: 33.0

DIMENSIONS - LID OPEN

H: 62.0 W: 55.0 D: 33.0



- Dual grilling space, main cooking area = 1,008 sq in
- Bottom grate 648 sq in, Top grate 360 sq in
- 200°-600°F temperature range
- SmokeBoost
- **WEBER CONNECT** smart grilling technology:
 - Step-by-step grilling assistance
 - Flip & serve notifications
 - Remote Grill Control and Monitoring
 - Remote Grill Shut Down
 - Diagnostic Alerts
- LCD display
- Includes two meat probes, four probe capacity
- Porcelain-enameled lid and cookbox
- Stainless steel **FLAVORIZER** bars
- High capacity hopper
- Low Fuel Sensor
- Plated steel cooking grates
- Large stainless steel side table with tool hooks
- Porcelain-enamel heat distribution plate
- Includes two glow plugs
- Heavy-duty steel cart frame
- Four swivel casters (2 locking, 2 non-locking)

FOB

MAP

MSRP

LUMIN COMPACT ELECTRIC GRILL

91010901 **\$282.11** \$429.00 \$529.00

LUMIN COMPACT ELECTRIC GRILL **BLACK**

MASTER CARTON: 1

H: 11.65 W: 16.6 D: 20.9 Wt: 35.75 Cu.Ft.: 2.3

DIMENSIONS - LID CLOSED

H: 11.0 W: 23.0 D: 16.5

DIMENSIONS - LID OPEN

H: 22.5 W: 23.0 D: 18.0



0 77924 19070 4

91300901 **\$301.84** \$459.00 \$559.00

LUMIN COMPACT ELECTRIC GRILL **DEEP OCEAN BLUE**

MASTER CARTON: 1

H: 11.65 W: 16.6 D: 20.9 Wt: 35.75 Cu.Ft.: 2.3

DIMENSIONS - LID CLOSED

H: 11.0 W: 23.0 D: 16.5

DIMENSIONS - LID OPEN

H: 22.5 W: 23.0 D: 18.0



0 77924 19619 5

91280901 **\$301.84** \$459.00 \$559.00

LUMIN COMPACT ELECTRIC GRILL **GOLDEN YELLOW**

MASTER CARTON: 1

H: 11.65 W: 16.6 D: 20.9 Wt: 35.75 Cu.Ft.: 2.3

DIMENSIONS - LID CLOSED

H: 11.0 W: 23.0 D: 16.5

DIMENSIONS - LID OPEN

H: 22.5 W: 23.0 D: 18.0



0 77924 19627 0

91070901 **\$301.84** \$459.00 \$559.00

LUMIN COMPACT ELECTRIC GRILL **SEAFOAM GREEN**

MASTER CARTON: 1

H: 11.65 W: 16.6 D: 20.9 Wt: 35.75 Cu.Ft.: 2.3

DIMENSIONS - LID CLOSED

H: 11.0 W: 23.0 D: 16.5

DIMENSIONS - LID OPEN

H: 22.5 W: 23.0 D: 18.0



0 77924 19623 2

91400901 **\$301.84** \$459.00 \$559.00

LUMIN COMPACT ELECTRIC GRILL **ICE BLUE**

MASTER CARTON: 1

H: 11.65 W: 16.6 D: 20.9 Wt: 35.75 Cu.Ft.: 2.3

DIMENSIONS - LID CLOSED

H: 11.0 W: 23.0 D: 16.5

DIMENSIONS - LID OPEN

H: 22.5 W: 23.0 D: 18.0



0 77924 19621 8

NEW



- Total cooking area = 178 square inches
- Reaches over 600°F (315°C)
- Sear, smoke, steam or boil
- Keep food warm for hours
- Thaw frozen food while preheating
- Available in a variety of colors: deep ocean blue, seafoam green, golden yellow, ice blue, and black
- Power = 120 V
- Porcelain-Enameled, Cast-Iron Cooking Grates
- Porcelain-Enameled lid
- Ceramic burners
- 6 ft power cord
- Reversible Steam Pan
- Steaming/Smoking Reservoir
- Temperature Controller
- Disposable Drip Tray
- Slide-Out Catch Pan
- Plastic Scraper

ELECTRIC GRILLS

FOB

MAP

MSRP

LUMIN ELECTRIC GRILL

92010901 **\$314.00** \$479.00 \$579.00

LUMIN ELECTRIC GRILL **BLACK**

MASTER CARTON: 1

H: 13.0 W: 19.65 D: 23.55 Wt: 46.65 Cu.Ft.: 3.5

DIMENSIONS - LID CLOSED

H: 12.0 W: 26.0 D: 19.0

DIMENSIONS - LID OPEN

H: 25.5 W: 25.5 D: 21.0



NEW



- Total cooking area = 237 square inches
- Reaches over 600°F (315°C)
- Sear, smoke, steam or boil
- Keep food warm for hours
- Thaw frozen food while preheating
- Available in a variety of colors: deep ocean blue, seafoam green, golden yellow, ice blue, and black
- Power = 120 V
- Porcelain-Enameled, Cast-Iron Cooking Grates
- Porcelain-Enameled lid
- Ceramic burners
- 6 ft power cord
- Reversible Steam Pan
- Steaming/Smoking Reservoir
- Temperature Controller
- Disposable Drip Tray
- Slide-Out Catch Pan
- Plastic Scraper

92300901 **\$340.22** \$519.00 \$619.00

LUMIN ELECTRIC GRILL **DEEP OCEAN BLUE**

MASTER CARTON: 1

H: 13.0 W: 19.65 D: 23.55 Wt: 46.65 Cu.Ft.: 3.5

DIMENSIONS - LID CLOSED

H: 12.0 W: 26.0 D: 19.0

DIMENSIONS - LID OPEN

H: 25.5 W: 25.5 D: 21.0



92280901 **\$340.22** \$519.00 \$619.00

LUMIN ELECTRIC GRILL **GOLDEN YELLOW**

MASTER CARTON: 1

H: 13.0 W: 19.65 D: 23.55 Wt: 46.65 Cu.Ft.: 3.5

DIMENSIONS - LID CLOSED

H: 12.0 W: 26.0 D: 19.0

DIMENSIONS - LID OPEN

H: 25.5 W: 25.5 D: 21.0



92070901 **\$340.22** \$519.00 \$619.00

LUMIN ELECTRIC GRILL **SEAFOAM GREEN**

MASTER CARTON: 1

H: 13.0 W: 19.65 D: 23.55 Wt: 46.65 Cu.Ft.: 3.5

DIMENSIONS - LID CLOSED

H: 12.0 W: 26.0 D: 19.0

DIMENSIONS - LID OPEN

H: 25.5 W: 25.5 D: 21.0



92400901 **\$340.22** \$519.00 \$619.00

LUMIN ELECTRIC GRILL **ICE BLUE**

MASTER CARTON: 1

H: 13.0 W: 19.65 D: 23.55 Wt: 46.65 Cu.Ft.: 3.5

DIMENSIONS - LID CLOSED

H: 12.0 W: 26.0 D: 19.0

DIMENSIONS - LID OPEN

H: 25.5 W: 25.5 D: 21.0



FOB

MAP

MSRP

WEBER Q 1400 ELECTRIC GRILL

52020001 **\$216.35** \$329.00 \$429.00

WEBER Q 1400 ELECTRIC GRILL DARK GRAY

MASTER CARTON: 1

H: 16.8 W: 28.3 D: 16.3 Wt: 28.0 Cu.Ft.: 4.4

DIMENSIONS - LID CLOSED

H: 14.5 W: 27.0 D: 16.5

DIMENSIONS - LID OPEN

H: 23.5 W: 27.0 D: 20.5



- Total cooking area = 189 square inches
- Porcelain-enameled, cast-iron cooking grates
- 1,560 watts - 120 volts
- Infinite heat control settings
- Aluminum heat retention liners
- Cast aluminum lid and body
- Glass-reinforced nylon frame
- Removable catch pan
- 6-foot grounded cord

WEBER Q 2400 ELECTRIC GRILL

55020001 **\$261.56** \$399.00 \$499.00

WEBER Q 2400 ELECTRIC GRILL DARK GRAY

MASTER CARTON: 1

H: 17.0 W: 32.5 D: 18.3 Wt: 43.0 Cu.Ft.: 6.0

DIMENSIONS - LID CLOSED

H: 14.5 W: 31.5 D: 19.5

DIMENSIONS - LID OPEN

H: 26.0 W: 31.5 D: 25.1



- Total cooking area = 280 square inches
- Porcelain-enameled, cast-iron cooking grates
- 1,560 watts - 120 volts
- Infinite heat control settings
- Aluminum heat retention liners
- Cast aluminum lid and body
- Glass-reinforced nylon frame
- Removable catch pan
- 6-foot grounded cord

ELECTRIC GRILLS

FOB

MAP

MSRP

PULSE 2000 ELECTRIC GRILL

5012001

\$544.92

\$849.00

\$999.00

PULSE 2000 ELECTRIC GRILL

BLACK

MASTER CARTON: 1

H: 17.44 W: 21.2 D: 30.85 Wt: 56.32 Cu.Ft.: 6.6

DIMENSIONS - LID CLOSED

H: 15.0 W: 28.0 D: 23.0

DIMENSIONS - LID OPEN

H: 30.0 W: 28.0 D: 23.0



- Total cooking area = 278 square inches
- **WEBER CONNECT** smart grilling technology:
 - Step-by-step grilling assistance
 - Flip & serve notifications
 - Remote Grill Control and Monitoring
 - Remote Grill Shut Down
 - Diagnostic Alerts
- Four temperature probe capacity (two included)
- Power = 120 V
- Porcelain-Enameled, Cast-Iron Cooking Grates
- Digital Precision Temperature Control
- Maximum temperature of 600° F
- Dual Zone Grilling
- Digital Thermometer
- Status Indicator Lights
- Grease Management System
- Removable Front Control Panel
- Tall Lid
- ON/OFF Push-Button with Built in GFCI

FOB

MAP

MSRP

WEBER TRAVELER GAS GRILL

9010001 **\$277.61** \$399.00 \$499.00

WEBER TRAVELER GAS GRILL BLACK LP

MASTER CARTON: 1

H: 14.7 W: 22.1 D: 42.7 Wt: 63.0 Cu.Ft.: 7.9

DIMENSIONS - LID CLOSED

H: 37.2 W: 43.6 D: 23.0

DIMENSIONS - LID OPEN

H: 50.0 W: 43.6 D: 26.0



9013001 **NEW** **\$312.40** \$449.00 \$549.00

WEBER TRAVELER GAS GRILL STEALTH LP

MASTER CARTON: 1

H: 14.7 W: 22.1 D: 42.7 Wt: 63.0 Cu.Ft.: 7.9

DIMENSIONS - LID CLOSED

H: 37.2 W: 43.6 D: 23.0

DIMENSIONS - LID OPEN

H: 50.0 W: 43.6 D: 26.0



- Total cooking area = 320 square inches
- One stainless steel burner
- 13,000 BTU-per-hour input main burner
- Porcelain-enameled, cast-iron cooking grates
- Push button ignition
- Infinite control burner valve
- Porcelain enameled steel lid and cookbox
- Integrated steel folding cart
- One hand set-up and fold with automatic lid lock
- Rigid, large side table
- Built-in lid thermometer
- Two rubberized outer wheels
- Removable catch pan
- Uses disposable 16 oz. LP cylinder (sold separately)
- Available in a variety of colors: deep ocean blue, red, stealth, and black

9020001 **NEW** **\$312.40** \$449.00 \$549.00

WEBER TRAVELER GAS GRILL DEEP OCEAN BLUE LP

MASTER CARTON: 1

H: 14.7 W: 22.1 D: 42.7 Wt: 63.0 Cu.Ft.: 7.9

DIMENSIONS - LID CLOSED

H: 37.2 W: 43.6 D: 23.0

DIMENSIONS - LID OPEN

H: 50.0 W: 43.6 D: 26.0



9030001 **NEW** **\$312.40** \$449.00 \$549.00

WEBER TRAVELER GAS GRILL RED LP

MASTER CARTON: 1

H: 14.7 W: 22.1 D: 42.7 Wt: 63.0 Cu.Ft.: 7.9

DIMENSIONS - LID CLOSED

H: 37.2 W: 43.6 D: 23.0

DIMENSIONS - LID OPEN

H: 50.0 W: 43.6 D: 26.0



GAS GRILLS

FOB

MAP

MSRP

WEBER Q 1000 GAS GRILL

50060001

\$148.45

\$229.00

\$279.00

WEBER Q 1000 GAS GRILL

TITANIUM

LP

MASTER CARTON: 1

H: 16.8 W: 28.3 D: 16.3 Wt: 28.0 Cu.Ft.: 4.4

DIMENSIONS - LID CLOSED

H: 14.5 W: 27.0 D: 16.5

DIMENSIONS - LID OPEN

H: 23.5 W: 27.0 D: 20.5



- Total cooking area = 189 square inches
- Stainless steel burner
- 8,500 BTU-per-hour input main burner
- Porcelain-enameled, cast-iron cooking grates
- Push button ignition
- Infinite control burner valve
- Cast aluminum lid and body
- Glass-reinforced nylon frame
- Removable catch pan
- Uses disposable 14.1 or 16.4 oz. LP cylinder (sold separately)

WEBER Q 1200 GAS GRILL

51060001

\$166.88

\$259.00

\$309.00

WEBER Q 1200 GAS GRILL

TITANIUM

LP

MASTER CARTON: 1

H: 17.0 W: 28.0 D: 16.0 Wt: 30.0 Cu.Ft.: 4.6

DIMENSIONS - LID CLOSED AND TABLES OUT

H: 15.5 W: 40.9 D: 16.5

DIMENSIONS - LID OPEN AND TABLES OUT

H: 24.6 W: 40.9 D: 20.5



- Total cooking area = 189 square inches
- Stainless steel burner
- 8,500 BTU-per-hour input main burner
- Porcelain-enameled, cast-iron cooking grates
- Electronic ignition
- Infinite control burner valve
- Cast aluminum lid and body
- Glass-reinforced nylon frame
- Two folding work tables
- Removable catch pan
- Built-in lid thermometer
- Uses disposable 14.1 or 16.4 oz. LP cylinder (sold separately)

51010001

BLACK LP



51080001

BLUE LP



51190001

ORANGE LP



51040001

RED LP



51070001

GREEN LP



FOB

MAP

MSRP

WEBER Q 2000 GAS GRILL

53060001 **\$192.50** \$299.00 \$349.00

WEBER Q 2000 GAS GRILL TITANIUM LP

MASTER CARTON: 1

H: 17.0 W: 32.5 D: 18.3 Wt: 43.0 Cu.Ft.: 5.7

DIMENSIONS - LID CLOSED AND TABLES OUT

H: 14.5 W: 51.4 D: 19.5

DIMENSIONS - LID OPEN

H: 26.0 W: 51.4 D: 24.3



- Total cooking area = 280 square inches
- Stainless steel burner
- 12,000 BTU-per-hour input main burner
- Porcelain-enameled, cast-iron cooking grates
- Push button ignition
- Infinite control burner valve
- Cast aluminum lid and body
- Glass-reinforced nylon frame
- Two folding work tables
- Removable catch pan
- Uses disposable 14.1 or 16.4 oz. LP cylinder (sold separately)

WEBER Q 2200 GAS GRILL

54060001 **\$213.43** \$329.00 \$429.00

WEBER Q 2200 GAS GRILL TITANIUM LP

MASTER CARTON: 1

H: 17.0 W: 32.5 D: 18.3 Wt: 45.0 Cu.Ft.: 6.0

DIMENSIONS - LID CLOSED AND TABLES OUT

H: 15.5 W: 51.4 D: 19.5

DIMENSIONS - LID OPEN AND TABLES OUT

H: 26.0 W: 51.4 D: 25.1



- Total cooking area = 280 square inches
- Stainless steel burner
- 12,000 BTU-per-hour input main burner
- Porcelain-enameled, cast-iron cooking grates
- Electronic ignition
- Infinite control burner valve
- Cast aluminum lid and body
- Glass-reinforced nylon frame
- Two folding work tables
- Removable catch pan
- Built-in lid thermometer
- Uses disposable 14.1 or 16.4 oz. LP cylinder (sold separately)

GAS GRILLS

FOB

MAP

MSRP

WEBER Q 3200 GAS GRILL

57060001

\$359.43

\$519.00

\$619.00

WEBER Q 3200 GAS GRILL

TITANIUM

LP

MASTER CARTON: 1

H: 21.0 W: 39.0 D: 29.3 Wt: 88.0 Cu.Ft.: 13.6

DIMENSIONS - LID CLOSED AND TABLES OUT

H: 43.5 W: 50.2 D: 21.0

DIMENSIONS - LID OPEN AND TABLES OUT

H: 55.5 W: 50.2 D: 30.0



57067001

\$374.32

\$539.00

\$639.00

WEBER Q 3200 GAS GRILL

TITANIUM

NG

MASTER CARTON: 1

H: 21.0 W: 39.0 D: 29.3 Wt: 88.0 Cu.Ft.: 13.6

DIMENSIONS - LID CLOSED AND TABLES OUT

H: 43.5 W: 50.2 D: 21.0

DIMENSIONS - LID OPEN AND TABLES OUT

H: 55.5 W: 50.2 D: 30.0



- Primary cooking area = 393 square inches
- Warming rack = 75 square inches
- Total cooking area = 468 square inches
- Two stainless steel burners
- 21,700 BTU-per-hour input main burners
- Porcelain-enameled, cast-iron cooking grates
- Electronic ignition
- Infinite control burner valves
- Cast aluminum lid and body
- Glass-reinforced nylon frame
- Removable folding work tables
- Built-in lid thermometer
- One handle light
- Bolts onto heavy-duty cart that includes three integrated tool hooks
- Tank holder (LP only) and storage area for tools and accessories
- Two durable all-weather wheels with full wheel hubs
- Removable catch pan
- LP gas grill includes a hose and regulator that connects to a 20 lb. LP tank (tank sold separately)
- Natural gas grill includes a 10-foot flexible hose

FOB

MAP

MSRP

SPIRIT II E-210 GAS GRILL

44010001 **\$348.55** \$449.00 \$549.00

SPIRIT II E-210 GAS GRILL BLACK LP

MASTER CARTON: 1

H: 20.5 W: 28.8 D: 27.3 Wt: 101.0 Cu.Ft.: 9.3

DIMENSIONS - LID CLOSED

H: 44.6 W: 48.3 D: 27.8 W (table down): 38.0

DIMENSIONS - LID OPEN

H: 57.1 W: 48.3 D: 27.8 W (table down): 38.0



- Infinity ignition
- Porcelain-enameled **FLAVORIZER** bars
- Grease management system
- Porcelain-enameled, cast-iron cooking grates
- Primary cooking area = 360 square inches
- Warming rack area = 90 square inches
- Total cooking area = 450 square inches
- Two stainless steel burners
- 26,500 BTU-per-hour input main burners
- Stainless steel heat deflector
- Porcelain-enameled lid with thermometer
- Fold down left side table
- Open cart design
- Fuel gauge - LP models only (tank not included)
- Six tool hooks
- Two large wheels

SPIRIT II E-310 GAS GRILL

45010001 **\$429.65** \$569.00 \$669.00

SPIRIT II E-310 GAS GRILL BLACK LP

MASTER CARTON: 1

H: 20.75 W: 31 D: 28.8 Wt: 116.0 Cu.Ft.: 10.7

DIMENSIONS - LID CLOSED

H: 44.6 W: 51.8 D: 27.8 W (table down): 42.0

DIMENSIONS - LID OPEN

H: 57.1 W: 51.8 D: 27.8 W (table down): 42.0



- Infinity ignition
- Porcelain-enameled **FLAVORIZER** bars
- Grease management system
- Porcelain-enameled, cast-iron cooking grates
- Primary cooking area = 424 square inches
- Warming rack area = 105 square inches
- Total cooking area = 529 square inches
- Three stainless steel burners
- 30,000 BTU-per-hour input main burners
- Stainless steel heat deflector
- Porcelain-enameled lid with thermometer
- Fold down left side table
- Open cart design
- Fuel gauge - LP models only (tank not included)
- Six tool hooks
- Two large wheels
- Natural gas grill includes 10-foot flexible hose

49010001 **\$429.65** \$569.00 \$669.00

SPIRIT II E-310 GAS GRILL BLACK NG

MASTER CARTON: 1

H: 20.75 W: 31 D: 28.8 Wt: 116.0 Cu.Ft.: 10.7

DIMENSIONS - LID CLOSED

H: 44.6 W: 51.8 D: 27.8 W (table down): 42.0

DIMENSIONS - LID OPEN

H: 57.1 W: 51.8 D: 27.8 W (table down): 42.0



GAS GRILLS

FOB

MAP

MSRP

SPIRIT E-210 GAS GRILL

46110001

\$380.54

\$499.00

\$599.00

SPIRIT E-210 GAS GRILL

BLACK

LP

MASTER CARTON: 1

H: 25.3 W: 32.0 D: 23.0 Wt: 117.0 Cu.Ft.: 10.8

DIMENSIONS - LID CLOSED

H: 45.8 W: 47.9 D: 25.8

DIMENSIONS - LID OPEN

H: 62.5 W: 47.9 D: 31.8



- Primary cooking area = 360 square inches
- Warming rack area = 90 square inches
- Total cooking area = 450 square inches
- Two stainless steel burners
- 26,500 BTU-per-hour input main burners
- Porcelain-enameled, cast-iron cooking grates
- Porcelain-enameled **FLAVORIZER** bars
- Electronic **CROSSOVER** ignition system
- Porcelain-enameled lid with center-mounted thermometer and painted aluminum end caps
- Two stainless steel fold-down tables
- Painted enclosed steel cabinet with painted steel door
- Front access, porcelain-enameled grease tray with catch pan
- Fuel gauge (tank not included)
- Six tool hooks
- Two heavy-duty front locking swivel casters
- Two heavy-duty back swivel casters

SPIRIT E-310 GAS GRILL

46510001

\$455.47

\$619.00

\$769.00

SPIRIT E-310 GAS GRILL

BLACK

LP

MASTER CARTON: 1

H: 25.3 W: 32.0 D: 25.5 Wt: 125.0 Cu.Ft.: 11.9

DIMENSIONS - LID CLOSED

H: 48.5 W: 51.6 D: 25.8

DIMENSIONS - LID OPEN

H: 62.5 W: 51.6 D: 31.8



- Primary cooking area = 424 square inches
- Warming rack area = 105 square inches
- Total cooking area = 529 square inches
- Three stainless steel burners
- 32,000 BTU-per-hour input main burners
- Porcelain-enameled, cast-iron cooking grates
- Porcelain-enameled **FLAVORIZER** bars
- Electronic **CROSSOVER** ignition system
- Porcelain-enameled lid with center-mounted thermometer and painted aluminum end caps
- Painted enclosed steel cabinet with painted steel door
- Front access, porcelain-enameled grease tray with catch pan
- Fuel gauge - LP models only (tank not included)
- Six tool hooks
- Two heavy-duty front locking swivel casters
- Two heavy-duty back swivel casters
- Natural gas grill includes a 10-foot flexible hose

47510001

\$455.47

\$619.00

\$769.00

SPIRIT E-310 GAS GRILL

BLACK

NG

MASTER CARTON: 1

H: 25.3 W: 32.0 D: 25.5 Wt: 125.0 Cu.Ft.: 11.9

DIMENSIONS - LID CLOSED

H: 48.5 W: 51.6 D: 25.8

DIMENSIONS - LID OPEN

H: 62.5 W: 51.6 D: 31.8



FOB

MAP

MSRP

SPIRIT E-330 GAS GRILL

46810001 **\$536.16** \$729.00 \$879.00

SPIRIT E-330 GAS GRILL BLACK LP

MASTER CARTON: 1

H: 25.3 W: 32.0 D: 25.5 Wt: 133.0 Cu.Ft.: 11.9

DIMENSIONS - LID CLOSED

H: 48.5 W: 51.6 D: 25.8

DIMENSIONS - LID OPEN

H: 62.5 W: 51.6 D: 31.8



- Primary cooking area = 424 square inches
- Warming rack area = 105 square inches
- Total cooking area = 529 square inches
- Three stainless steel burners
- 32,000 BTU-per-hour input main burners
- 10,000 BTU-per-hour input side burner
- 7,500 BTU-per-hour input **SEAR STATION** burner
- Porcelain-enameled, cast-iron cooking grates
- Porcelain-enameled **FLAVORIZER** bars
- Electronic **CROSSOVER** ignition system
- Porcelain-enameled lid with center-mounted thermometer and painted aluminum end caps
- Painted enclosed steel cabinet with painted steel door
- Front access, porcelain-enameled grease tray with catch pan
- Fuel gauge - LP models only (tank not included)
- Six tool hooks
- Two heavy-duty front locking swivel casters
- Two heavy-duty back swivel casters
- Not available in natural gas

SPIRIT S-315 GAS GRILL

46502001 **\$503.51** \$709.00 \$859.00

SPIRIT S-315 GAS GRILL STAINLESS STEEL LP

MASTER CARTON: 1

H: 25.2 W: 31.9 D: 25.4 Wt: 124.7 Cu.Ft.: 11.8

DIMENSIONS - LID CLOSED

H: 45.8 W: 49.4 D: 25.8

DIMENSIONS - LID OPEN

H: 62.5 W: 49.4 D: 31.8



- Primary cooking area = 424 square inches
- Warming rack area = 105 square inches
- Total cooking area = 529 square inches
- Three stainless steel burners
- 32,000 BTU-per-hour input main burners
- Porcelain-enameled, cast-iron cooking grates
- Stainless steel **FLAVORIZER** bars
- Electronic **CROSSOVER** ignition system
- Stainless Steel lid with center-mounted thermometer and painted aluminum end caps
- Enclosed steel cabinet with stainless steel door
- Front access, porcelain-enameled grease tray with catch pan
- Fuel gauge - LP models only (tank not included)
- 2 Chrome tool hooks
- Two heavy-duty front locking swivel casters
- Two heavy-duty back swivel casters
- Natural gas grill includes a 10-foot flexible hose

47502001 **\$503.51** \$709.00 \$859.00

SPIRIT S-315 GAS GRILL STAINLESS STEEL NG

MASTER CARTON: 1

H: 25.2 W: 31.9 D: 25.4 Wt: 124.7 Cu.Ft.: 11.8

DIMENSIONS - LID CLOSED

H: 45.8 W: 49.4 D: 25.8

DIMENSIONS - LID OPEN

H: 62.5 W: 49.4 D: 31.8



GAS GRILLS

FOB

MAP

MSRP

SPIRIT SMART GRILL EX-315

46512401 **\$604.46** \$769.00 \$919.00

SPIRIT EX-315 SMART GAS GRILL BLACK LP

MASTER CARTON: 1

H: 26.0 W: 32.5 D: 26.0 Wt: 122.7 Cu.Ft.: 12.6

DIMENSIONS - LID CLOSED

H: 45.8 W: 50.1 D: 25.8

DIMENSIONS - LID OPEN

H: 62.5 W: 50.1 D: 31.8



- Integrated **WEBER CONNECT** smart grilling technology:
 - Step-by-step grilling assistance
 - Real time food temperature monitoring
 - WiFi connected for remote grill access
 - Low fuel indications on your phone
 - Integrated ambient thermometer to measure temp of the grill
- Digital LED display
- Includes one meat probe, two probe capacity
- Primary cooking area = 424 square inches
- Warming rack area = 105 square inches
- Total cooking area = 529 square inches
- Three stainless steel burners
- 32,000 BTU-per-hour input main burners
- Porcelain-enameled, cast-iron cooking grates
- Stainless steel **FLAVORIZER** bars
- Electronic **CROSSOVER** ignition system
- Porcelain-enameled lid
- Painted enclosed steel cabinet with painted steel door
- Front access, porcelain-enameled grease tray with catch pan
- Fuel gauge - LP models only (tank not included)
- 2 Chrome tool hooks
- Two heavy-duty front locking swivel casters
- Two heavy-duty back swivel casters
- Natural gas grill includes a 10-foot flexible hose

47512401 **\$604.46** \$769.00 \$919.00

SPIRIT EX-315 SMART GAS GRILL BLACK NG

MASTER CARTON: 1

H: 26.0 W: 32.5 D: 26.0 Wt: 122.7 Cu.Ft.: 12.6

DIMENSIONS - LID CLOSED

H: 45.8 W: 50.1 D: 25.8

DIMENSIONS - LID OPEN

H: 62.5 W: 50.1 D: 31.8



SPIRIT SMART GRILL EX-325s

46912401 **\$649.89** \$869.00 \$1,019.00

SPIRIT EX-325s SMART GAS GRILL BLACK LP

MASTER CARTON: 1

H: 26.0 W: 32.5 D: 26.0 Wt: 125.2 Cu.Ft.: 12.6

DIMENSIONS - LID CLOSED

H: 45.8 W: 50.1 D: 25.8

DIMENSIONS - LID OPEN

H: 62.5 W: 50.1 D: 31.8



- Integrated **WEBER CONNECT** smart grilling technology:
 - Step-by-step grilling assistance
 - Real time food temperature monitoring
 - WiFi connected for remote grill access
 - Low fuel indications on your phone
 - Integrated ambient thermometer to measure temp of the grill
- Digital LED display
- Includes one meat probe, two probe capacity
- Primary cooking area = 424 square inches
- Warming rack area = 105 square inches
- Total cooking area = 529 square inches
- Three stainless steel burners
- 32,000 BTU-per-hour input main burners
- 7,500 BTU-per-hour input Sear Zone burner
- Porcelain-enameled, cast-iron cooking grates
- Stainless steel **FLAVORIZER** bars
- Electronic **CROSSOVER** ignition system
- Porcelain-enameled lid
- Painted enclosed steel cabinet with painted steel door
- Front access, porcelain-enameled grease tray with catch pan
- Fuel gauge - LP models only (tank not included)
- 2 Chrome tool hooks
- Two heavy-duty front locking swivel casters
- Two heavy-duty back swivel casters
- Natural gas grill includes a 10-foot flexible hose

47912401 **\$649.89** \$869.00 \$1,019.00

SPIRIT EX-325s SMART GAS GRILL BLACK NG

MASTER CARTON: 1

H: 26.0 W: 32.5 D: 26.0 Wt: 125.2 Cu.Ft.: 12.6

DIMENSIONS - LID CLOSED

H: 45.8 W: 50.1 D: 25.8

DIMENSIONS - LID OPEN

H: 62.5 W: 50.1 D: 31.8



FOB

MAP

MSRP

SPIRIT SMART GRILL SX-315

46502401 **\$686.89** \$869.00 \$1,019.00

SPIRIT SX-315 GAS GRILL STAINLESS STEEL LP

MASTER CARTON: 1

H: 26.0 W: 32.4 D: 25.8 Wt: 122.7 Cu.Ft.: 12.6

DIMENSIONS - LID CLOSED

H: 45.8 W: 50.1 D: 25.8

DIMENSIONS - LID OPEN

H: 62.5 W: 50.1 D: 31.8



- Integrated **WEBER CONNECT** smart grilling technology:
 - Step-by-step grilling assistance
 - Real time food temperature monitoring
 - WiFi connected for remote grill access
 - Low fuel indications on your phone
 - Integrated ambient thermometer to measure temp of the grill
- Digital LED display
- Includes one meat probe, two probe capacity
- Primary cooking area = 424 square inches
- Warming rack area = 105 square inches
- Total cooking area = 529 square inches
- Three stainless steel burners
- 32,000 BTU-per-hour input main burners
- Porcelain-enameled, cast-iron cooking grates
- Stainless steel **FLAVORIZER** bars
- Electronic **CROSSOVER** ignition system
- Stainless Steel lid
- Enclosed steel cabinet with stainless steel door
- Front access, porcelain-enameled grease tray with catch pan
- Fuel gauge - LP models only (tank not included)
- 2 Chrome tool hooks
- Two heavy-duty front locking swivel casters
- Two heavy-duty back swivel casters
- Natural gas grill includes a 10-foot flexible hose

47502401 **\$686.89** \$869.00 \$1,019.00

SPIRIT SX-315 GAS GRILL STAINLESS STEEL NG

MASTER CARTON: 1

H: 26.0 W: 32.4 D: 25.8 Wt: 122.7 Cu.Ft.: 12.6

DIMENSIONS - LID CLOSED

H: 45.8 W: 50.1 D: 25.8

DIMENSIONS - LID OPEN

H: 62.5 W: 50.1 D: 31.8



GAS GRILLS

FOB

MAP

MSRP

GENESIS E-325s GAS GRILL

35310001 **\$717.65** \$999.00 \$1,149.00

GENESIS E-325s GAS GRILL **BLACK** **LP**

MASTER CARTON: 1

H: 25.98 **W:** 30.32 **D:** 36.06 **Wt:** 188.0 **Cu.Ft.:** 16.4

DIMENSIONS - LID CLOSED

H: 48.1 **W:** 61.5 **D:** 27.0

DIMENSIONS - LID OPEN

H: 62.1 **W:** 61.5 **D:** 30.6



- Primary cooking area = 513 square inches
- Expandable cooking grate area = 274 square inches
- Total cooking area = 787 square inches
- Three stainless steel burners
- 39,000 BTU-per-hour input main burners
- 13,000 BTU-per-hour input **SEAR ZONE** burner
- **WEBER CRAFTED** porcelain-enameled, cast-iron cooking grates
- Stainless steel **FLAVORIZER** bars
- Flush electronic push button ignition system, 1 AA battery included
- Porcelain-enameled lid with thermometer
- Extra large prep & serve table
- Painted enclosed steel cabinet with painted steel door
- Pull & clean grease management system
- One grease scraper included
- Visible front tanks scale
- Fuel gauge - LP models only (tank not included)
- Six tool hooks
- Two front locking castors / Two back swivel casters
- Propane tank inside the cabinet
- Natural gas grill includes a 10-foot flexible hose

37310001 **\$717.65** \$999.00 \$1,149.00

GENESIS E-325s GAS GRILL **BLACK** **NG**

MASTER CARTON: 1

H: 25.98 **W:** 30.32 **D:** 36.06 **Wt:** 188.0 **Cu.Ft.:** 16.4

DIMENSIONS - LID CLOSED

H: 48.1 **W:** 61.5 **D:** 27.0

DIMENSIONS - LID OPEN

H: 62.1 **W:** 61.5 **D:** 30.6



35320001 **\$717.65** \$999.00 \$1,149.00

GENESIS E-325s GAS GRILL **COPPER** **LP**

MASTER CARTON: 1

H: 32.13 **W:** 30.9 **D:** 35.75 **Wt:** 188.0 **Cu.Ft.:** 20.5

DIMENSIONS - LID CLOSED

H: 48.1 **W:** 61.5 **D:** 27.0

DIMENSIONS - LID OPEN

H: 62.1 **W:** 61.5 **D:** 30.6



37320001 **\$717.65** \$999.00 \$1,149.00

GENESIS E-325s GAS GRILL **COPPER** **NG**

MASTER CARTON: 1

H: 32.13 **W:** 30.9 **D:** 35.75 **Wt:** 188.0 **Cu.Ft.:** 20.5

DIMENSIONS - LID CLOSED

H: 48.1 **W:** 61.5 **D:** 27.0

DIMENSIONS - LID OPEN

H: 62.1 **W:** 61.5 **D:** 30.6



FOB

MAP

MSRP

GENESIS E-325s GAS GRILL with WEBER CRAFTED GRIDDLE

35913401 **\$815.07** \$1,159.00 \$1,359.00

GENESIS E-325s GAS GRILL with WEBER CRAFTED GRIDDLE BLACK LP

MASTER CARTON: 1

H: 32.13 W: 30.9 D: 35.75 Wt: 210.0 Cu.Ft.: 20.5

DIMENSIONS - LID CLOSED

H: 48.1 W: 61.5 D: 27.0

DIMENSIONS - LID OPEN

H: 62.1 W: 61.5 D: 30.6



37913401 **\$815.07** \$1,159.00 \$1,359.00

GENESIS E-325s GAS GRILL with WEBER CRAFTED GRIDDLE BLACK NG

MASTER CARTON: 1

H: 32.13 W: 30.9 D: 35.75 Wt: 210.0 Cu.Ft.: 20.5

DIMENSIONS - LID CLOSED

H: 48.1 W: 61.5 D: 27.0

DIMENSIONS - LID OPEN

H: 62.1 W: 61.5 D: 30.6



- Primary cooking area = 513 square inches
- Expandable cooking grate area = 274 square inches
- Total cooking area = 787 square inches
- Three stainless steel burners
- 39,000 BTU-per-hour input main burners
- 13,000 BTU-per-hour input **SEAR ZONE** burner
- **WEBER CRAFTED** porcelain-enameled, cast-iron cooking grates
- **WEBER CRAFTED** Flattop Griddle included
- **WEBER CRAFTED** Frame Kit - **GENESIS** included
- Stainless steel **FLAVORIZER** bars
- Flush electronic push button ignition system, 1 AA battery included
- Porcelain-enameled lid with thermometer
- Extra large prep & serve table
- Painted enclosed steel cabinet with painted steel door
- Pull & clean grease management system
- One grease scraper included
- Visible front tanks scale
- Fuel gauge - LP models only (tank not included)
- Six tool hooks
- Two front locking castors / Two back swivel casters
- Propane tank inside the cabinet
- Natural gas grill includes a 10-foot flexible hose

GAS GRILLS

FOB

MAP

MSRP

GENESIS S-325s GAS GRILL

35300001

\$791.32

\$1,129.00

\$1,329.00

GENESIS S-325s GAS GRILL

STAINLESS STEEL

LP

MASTER CARTON: 1

H: 32.13 W: 30.9 D: 35.75 Wt: 179.0 Cu.Ft.: 20.5

DIMENSIONS - LID CLOSED

H: 48.1 W: 61.5 D: 27.0

DIMENSIONS - LID OPEN

H: 62.1 W: 61.5 D: 30.6



- Primary cooking area = 513 square inches
- Expandable cooking grate area = 274 square inches
- Total cooking area = 787 square inches
- Three stainless steel burners
- 39,000 BTU-per-hour input main burners
- 13,000 BTU-per-hour input **SEAR ZONE** burner
- **WEBER CRAFTED** 7mm stainless steel cooking grates
- Stainless steel **FLAVORIZER** bars
- Flush electronic push button ignition system, 1 AA battery included
- Stainless steel lid with thermometer
- Extra large prep & serve table
- Painted enclosed steel cabinet with painted steel door
- Pull & clean grease management system
- One grease scraper included
- Visible front tanks scale
- Fuel gauge - LP models only (tank not included)
- Six tool hooks
- Two front locking castors / Two back swivel casters
- Propane tank inside the cabinet
- Natural gas grill includes a 10-foot flexible hose

37300001

\$791.32

\$1,129.00

\$1,329.00

GENESIS S-325s GAS GRILL

STAINLESS STEEL

NG

MASTER CARTON: 1

H: 32.13 W: 30.9 D: 35.75 Wt: 180.0 Cu.Ft.: 20.5

DIMENSIONS - LID CLOSED

H: 48.1 W: 61.5 D: 27.0

DIMENSIONS - LID OPEN

H: 62.1 W: 61.5 D: 30.6



FOB

MAP

MSRP

GENESIS E-335 GAS GRILL

35410001	\$953.58	\$1,319.00	\$1,519.00
GENESIS E-335 GAS GRILL	BLACK	LP	
MASTER CARTON: 1			
H: 25.98	W: 30.32	D: 42.72	Wt: 210.0 Cu.Ft.: 19.5
DIMENSIONS - LID CLOSED			
H: 48.1	W: 61.5	D: 27.0	
DIMENSIONS - LID OPEN			
H: 62.1	W: 61.5	D: 30.6	



- Primary cooking area = 513 square inches
- Expandable cooking grate area = 274 square inches
- Total cooking area = 787 square inches
- Three stainless steel burners
- 39,000 BTU-per-hour input main burners
- 13,000 BTU-per-hour input **SEAR ZONE** burner
- 12,000 BTU-per-hour input side burner
- Porcelain-enameled, cast-iron cooking grates
- **WEBER CRAFTED** cooking grates & frame
- Stainless steel **FLAVORIZER** bars
- Flush electronic push button ignition system, 1 AA battery included
- Porcelain-enameled lid with thermometer
- Extra large prep & serve table
- Painted enclosed steel cabinet with painted steel door
- Grill locker
- Pull & clean grease management system
- One grease scraper included
- Visible front tanks scale
- Fuel gauge - LP models only (tank not included)
- Six tool hooks
- Two front locking castors / Two back swivel casters
- Propane tank inside the cabinet
- Natural gas grill includes a 10-foot flexible hose

37410001	\$953.58	\$1,319.00	\$1,519.00
GENESIS E-335 GAS GRILL	BLACK	NG	
MASTER CARTON: 1			
H: 25.98	W: 30.32	D: 42.72	Wt: 210.0 Cu.Ft.: 19.5
DIMENSIONS - LID CLOSED			
H: 48.1	W: 61.5	D: 27.0	
DIMENSIONS - LID OPEN			
H: 62.1	W: 61.5	D: 30.6	



35480001	\$953.58	\$1,319.00	\$1,519.00
GENESIS E-335 GAS GRILL	DEEP OCEAN BLUE	LP	
MASTER CARTON: 1			
H: 32.13	W: 30.88	D: 35.75	Wt: 210.0 Cu.Ft.: 20.5
DIMENSIONS - LID CLOSED			
H: 48.1	W: 61.5	D: 27.0	
DIMENSIONS - LID OPEN			
H: 62.1	W: 61.5	D: 30.6	



37480001	\$953.58	\$1,319.00	\$1,519.00
GENESIS E-335 GAS GRILL	DEEP OCEAN BLUE	NG	
MASTER CARTON: 1			
H: 32.13	W: 30.88	D: 35.75	Wt: 210.0 Cu.Ft.: 20.5
DIMENSIONS - LID CLOSED			
H: 48.1	W: 61.5	D: 27.0	
DIMENSIONS - LID OPEN			
H: 62.1	W: 61.5	D: 30.6	



GAS GRILLS

FOB

MAP

MSRP

GENESIS S-335 GAS GRILL

35400001

\$1,024.57

\$1,429.00

\$1,629.00

GENESIS S-335 GAS GRILL

STAINLESS STEEL

LP

MASTER CARTON: 1

H: 32.13 W: 30.88 D: 35.75 Wt: 212.6 Cu.Ft.: 20.5

DIMENSIONS - LID CLOSED

H: 48.1 W: 61.5 D: 27.0

DIMENSIONS - LID OPEN

H: 62.1 W: 61.5 D: 30.6



- Primary cooking area = 513 square inches
- Expandable cooking grate area = 274 square inches
- Total cooking area = 787 square inches
- Three stainless steel burners
- 39,000 BTU-per-hour input main burners
- 13,000 BTU-per-hour input **SEAR ZONE** burner
- 12,000 BTU-per-hour input side burner
- 7mm stainless steel cooking grates
- **WEBER CRAFTED** cooking grates & frame
- Stainless steel **FLAVORIZER** bars
- Flush electronic push button ignition system, 1 AA battery included
- Stainless steel lid with thermometer
- Extra large prep & serve table
- Stainless steel cabinet with painted steel door
- Grill locker
- Pull & clean grease management system
- One grease scraper included
- Visible front tanks scale
- Fuel gauge - LP models only (tank not included)
- Six tool hooks
- Two front locking castors / Two back swivel casters
- Propane tank inside the cabinet
- Natural gas grill includes a 10-foot flexible hose

37400001

\$1,024.57

\$1,429.00

\$1,629.00

GENESIS S-335 GAS GRILL

STAINLESS STEEL

NG

MASTER CARTON: 1

H: 32.13 W: 30.88 D: 35.75 Wt: 207.0 Cu.Ft.: 20.5

DIMENSIONS - LID CLOSED

H: 48.1 W: 61.5 D: 27.0

DIMENSIONS - LID OPEN

H: 62.1 W: 61.5 D: 30.6



FOB

MAP

MSRP

GENESIS E-435 GAS GRILL

36410001	\$1,193.82	\$1,649.00	\$1,899.00
GENESIS E-435 GAS GRILL	BLACK	LP	
MASTER CARTON: 1			
H: 25.98	W: 35.43	D: 45.3	Wt: 220.0 Cu.Ft.: 24.1
DIMENSIONS - LID CLOSED			
H: 48.1	W: 68.5	D: 27.0	
DIMENSIONS - LID OPEN			
H: 62.1	W: 68.5	D: 30.6	



- Primary cooking area = 646 square inches
- Expandable cooking grate area = 348 square inches
- Total cooking area = 994 square inches
- Four stainless steel burners
- 48,000 BTU-per-hour input main burners
- 12,000 BTU-per-hour input **SEAR ZONE** burner
- 12,000 BTU-per-hour input side burner
- Porcelain-enameled, cast-iron cooking grates
- **WEBER CRAFTED** cooking grates & frame
- Stainless steel **FLAVORIZER** bars
- Flush electronic push button ignition system, 1 AA battery included
- Porcelain-enameled lid with thermometer
- Extra large prep & serve table
- Painted enclosed steel cabinet with painted steel door
- Grill locker
- Pull & clean grease management system
- One grease scraper included
- Visible front tanks scale
- Fuel gauge - LP models only (tank not included)
- Six tool hooks
- Two front locking castors / Two back swivel casters
- Propane tank inside the cabinet
- Natural gas grill includes a 10-foot flexible hose

38410001	\$1,193.82	\$1,649.00	\$1,899.00
GENESIS E-435 GAS GRILL	BLACK	NG	
MASTER CARTON: 1			
H: 25.98	W: 35.43	D: 45.3	Wt: 220.0 Cu.Ft.: 24.1
DIMENSIONS - LID CLOSED			
H: 48.1	W: 68.5	D: 27.0	
DIMENSIONS - LID OPEN			
H: 62.1	W: 68.5	D: 30.6	



GENESIS S-435 GAS GRILL

36400001	\$1,250.51	\$1,749.00	\$1,999.00
GENESIS S-435 GAS GRILL	STAINLESS STEEL	LP	
MASTER CARTON: 1			
H: 32.38	W: 36.0	D: 38.19	Wt: 237.0 Cu.Ft.: 25.8
DIMENSIONS - LID CLOSED			
H: 48.1	W: 68.5	D: 27.0	
DIMENSIONS - LID OPEN			
H: 62.1	W: 68.5	D: 30.6	



- Primary cooking area = 646 square inches
- Expandable cooking grate area = 348 square inches
- Total cooking area = 994 square inches
- Four stainless steel burners
- 48,000 BTU-per-hour input main burners
- 12,000 BTU-per-hour input **SEAR ZONE** burner
- 12,000 BTU-per-hour input side burner
- 7mm stainless steel cooking grates
- **WEBER CRAFTED** cooking grates & frame
- Stainless steel **FLAVORIZER** bars
- Flush electronic push button ignition system, 1 AA battery included
- Stainless steel lid with thermometer
- Extra large prep & serve table
- Stainless steel cabinet with painted steel door
- Grill locker
- Pull & clean grease management system
- One grease scraper included
- Visible front tanks scale
- Fuel gauge - LP models only (tank not included)
- Six tool hooks
- Two front locking castors / Two back swivel casters
- Propane tank inside the cabinet
- Natural gas grill includes a 10-foot flexible hose

38400001	\$1,250.51	\$1,749.00	\$1,999.00
GENESIS S-435 GAS GRILL	STAINLESS STEEL	NG	
MASTER CARTON: 1			
H: 32.38	W: 36.0	D: 38.19	Wt: 240.0 Cu.Ft.: 25.8
DIMENSIONS - LID CLOSED			
H: 48.1	W: 68.5	D: 27.0	
DIMENSIONS - LID OPEN			
H: 62.1	W: 68.5	D: 30.6	



GAS GRILLS

FOB

MAP

MSRP

GENESIS EX-325s SMART GAS GRILL

35510001

\$847.15

\$1,179.00

\$1,379.00

GENESIS EX-325s GAS GRILL

BLACK

LP

MASTER CARTON: 1

H: 32.13 W: 30.9 D: 35.75 Wt: 188.0 Cu.Ft.: 20.5

DIMENSIONS - LID CLOSED

H: 48.1 W: 61.5 D: 27.0

DIMENSIONS - LID OPEN

H: 62.1 W: 61.5 D: 30.6



37510001

\$847.15

\$1,179.00

\$1,379.00

GENESIS EX-325s GAS GRILL

BLACK

NG

MASTER CARTON: 1

H: 32.13 W: 30.9 D: 35.75 Wt: 188.0 Cu.Ft.: 20.5

DIMENSIONS - LID CLOSED

H: 48.1 W: 61.5 D: 27.0

DIMENSIONS - LID OPEN

H: 62.1 W: 61.5 D: 30.6



- Integrated **WEBER CONNECT** smart grilling technology:
 - Step-by-step grilling assistance
 - Real time food temperature monitoring
 - WiFi connected for remote grill access
 - Low fuel indications on your phone
 - Integrated ambient thermometer to measure temp of the grill
- Digital LED display
- Includes one meat probe, two probe capacity
- Primary cooking area = 513 square inches
- Expandable cooking grate area = 274 square inches
- Total cooking area = 787 square inches
- Three stainless steel burners
- 39,000 BTU-per-hour input main burners
- 13,000 BTU-per-hour input **SEAR ZONE** burner
- Porcelain-enameled, cast-iron cooking grates
- Stainless steel **FLAVORIZER** bars
- Flush electronic push button ignition system, 1 AA battery included
- Porcelain-enameled lid
- Extra large prep & serve table
- Painted enclosed steel cabinet with painted steel door
- Pull & clean grease management system
- One grease scraper included
- Visible front tanks scale
- Fuel gauge - LP models only (tank not included)
- Six tool hooks
- Two front locking castors / Two back swivel casters
- Propane tank inside the cabinet
- Natural gas grill includes a 10-foot flexible hose

FOB

MAP

MSRP

GENESIS SX-325s SMART GAS GRILL

35500001 **\$925.24** \$1,319.00 \$1,519.00

GENESIS SX-325s GAS GRILL STAINLESS STEEL LP

MASTER CARTON: 1

H: 32.13 W: 30.9 D: 35.75 Wt: 183.5 Cu.Ft.: 20.5

DIMENSIONS - LID CLOSED

H: 48.1 W: 61.5 D: 27.0

DIMENSIONS - LID OPEN

H: 62.1 W: 61.5 D: 30.6



- Integrated **WEBER CONNECT** smart grilling technology:
 - Step-by-step grilling assistance
 - Real time food temperature monitoring
 - WiFi connected for remote grill access
 - Low fuel indications on your phone
 - Integrated ambient thermometer to measure temp of the grill
- Digital LED display
- Includes one meat probe, two probe capacity
- Primary cooking area = 513 square inches
- Expandable cooking grate area = 274 square inches
- Total cooking area = 787 square inches
- Three stainless steel burners
- 39,000 BTU-per-hour input main burners
- 13,000 BTU-per-hour input **SEAR ZONE** burner
- 7mm stainless steel cooking grates
- Stainless steel **FLAVORIZER** bars
- Flush electronic push button ignition system, 1 AA battery included
- Stainless steel lid
- Extra large prep & serve table
- Stainless steel cabinet with painted steel door
- Pull & clean grease management system
- One grease scraper included
- Visible front tanks scale
- Fuel gauge - LP models only (tank not included)
- Six tool hooks
- Two front locking castors / Two back swivel casters
- Propane tank inside the cabinet
- Natural gas grill includes a 10-foot flexible hose

37500001 **\$925.24** \$1,319.00 \$1,519.00

GENESIS SX-325s GAS GRILL STAINLESS STEEL NG

MASTER CARTON: 1

H: 32.13 W: 30.9 D: 35.75 Wt: 183.5 Cu.Ft.: 20.5

DIMENSIONS - LID CLOSED

H: 48.1 W: 61.5 D: 27.0

DIMENSIONS - LID OPEN

H: 62.1 W: 61.5 D: 30.6



GAS GRILLS

FOB

MAP

MSRP

GENESIS EX-335 SMART GAS GRILL

35610001 **\$1,088.20** \$1,479.00 \$1,679.00

GENESIS EX-335 GAS GRILL BLACK LP

MASTER CARTON: 1

H: 32.13 W: 30.88 D: 35.75 Wt: 212.6 Cu.Ft.: 20.5

DIMENSIONS - LID CLOSED

H: 48.1 W: 61.5 D: 27.0

DIMENSIONS - LID OPEN

H: 62.1 W: 61.5 D: 30.6



- Integrated **WEBER CONNECT** smart grilling technology:
 - Step-by-step grilling assistance
 - Real time food temperature monitoring
 - WiFi connected for remote grill access
 - Low fuel indications on your phone
 - Integrated ambient thermometer to measure temp of the grill

37610001 **\$1,088.20** \$1,479.00 \$1,679.00

GENESIS EX-335 GAS GRILL BLACK NG

MASTER CARTON: 1

H: 32.13 W: 30.88 D: 35.75 Wt: 210.0 Cu.Ft.: 20.5

DIMENSIONS - LID CLOSED

H: 48.1 W: 61.5 D: 27.0

DIMENSIONS - LID OPEN

H: 62.1 W: 61.5 D: 30.6



- Digital LED display
- Includes one meat probe, two probe capacity
- Primary cooking area = 513 square inches
- Expandable cooking grate area = 274 square inches
- Total cooking area = 787 square inches
- Three stainless steel burners
- 39,000 BTU-per-hour input main burners
- 13,000 BTU-per-hour input **SEAR ZONE** burner
- 12,000 BTU-per-hour input side burner
- Porcelain-enameled, cast-iron cooking grates
- **WEBER CRAFTED** cooking grates & frame
- Stainless steel **FLAVORIZER** bars
- Flush electronic push button ignition system, 1 AA battery included
- Porcelain-enameled lid
- Extra large prep & serve table
- Painted enclosed steel cabinet with painted steel door
- Grill locker
- Pull & clean grease management system
- One grease scraper included
- Visible front tanks scale
- Fuel gauge - LP models only (tank not included)
- Six tool hooks
- Two front locking castors / Two back swivel casters
- Propane tank inside the cabinet
- Natural gas grill includes a 10-foot flexible hose

FOB

MAP

MSRP

GENESIS SX-335 SMART GAS GRILL

35600001 **\$1,153.66** \$1,599.00 \$1,849.00

GENESIS SX-335 GAS GRILL **STAINLESS STEEL** **LP**

MASTER CARTON: 1

H: 32.13 W: 30.88 D: 35.75 Wt: 245.6 Cu.Ft.: 20.5

DIMENSIONS - LID CLOSED

H: 48.1 W: 61.5 D: 27.0

DIMENSIONS - LID OPEN

H: 62.1 W: 61.5 D: 30.6



- Integrated **WEBER CONNECT** smart grilling technology:
 - Step-by-step grilling assistance
 - Real time food temperature monitoring
 - WiFi connected for remote grill access
 - Low fuel indications on your phone
 - Integrated ambient thermometer to measure temp of the grill

37600001 **\$1,153.66** \$1,599.00 \$1,849.00

GENESIS SX-335 GAS GRILL **STAINLESS STEEL** **NG**

MASTER CARTON: 1

H: 32.13 W: 30.88 D: 35.75 Wt: 245.6 Cu.Ft.: 20.5

DIMENSIONS - LID CLOSED

H: 48.1 W: 61.5 D: 27.0

DIMENSIONS - LID OPEN

H: 62.1 W: 61.5 D: 30.6



- Digital LED display
- Includes one meat probe, two probe capacity
- Primary cooking area = 513 square inches
- Expandable cooking grate area = 274 square inches
- Total cooking area = 787 square inches
- Three stainless steel burners
- 39,000 BTU-per-hour input main burners
- 13,000 BTU-per-hour input **SEAR ZONE** burner
- 12,000 BTU-per-hour input side burner
- 7mm stainless steel cooking grates
- **WEBER CRAFTED** cooking grates & frame
- Stainless steel **FLAVORIZER** bars
- Flush electronic push button ignition system, 1 AA battery included
- Stainless steel lid
- Extra large prep & serve table
- Stainless steel cabinet with painted steel door
- Grill locker
- Pull & clean grease management system
- One grease scraper included
- Visible front tanks scale
- Fuel gauge - LP models only (tank not included)
- Six tool hooks
- Two front locking castors / Two back swivel casters
- Propane tank inside the cabinet
- Natural gas grill includes a 10-foot flexible hose

GAS GRILLS

FOB

MAP

MSRP

GENESIS EPX-335 SMART GAS GRILL

35810001 **\$1,226.49** \$1,699.00 \$1,949.00

GENESIS EPX-335 GAS GRILL BLACK LP

MASTER CARTON: 1

H: 32.13 W: 30.88 D: 35.75 Wt: 210.0 Cu.Ft.: 20.5

DIMENSIONS - LID CLOSED

H: 48.1 W: 61.5 D: 27.0

DIMENSIONS - LID OPEN

H: 62.1 W: 61.5 D: 30.6



- Integrated **WEBER CONNECT** smart grilling technology:
 - Step-by-step grilling assistance
 - Real time food temperature monitoring
 - WiFi connected for remote grill access
 - Low fuel indications on your phone
 - Integrated ambient thermometer to measure temp of the grill
- Digital LED display
- Includes one meat probe, two probe capacity
- Primary cooking area = 513 square inches
- Expandable cooking grate area = 274 square inches
- Total cooking area = 787 square inches
- Three stainless steel burners
- 39,000 BTU-per-hour input main burners
- 13,000 BTU-per-hour input **SEAR ZONE** burner
- 12,000 BTU-per-hour input side burner
- Porcelain-enameled, cast-iron cooking grates
- **WEBER CRAFTED** cooking grates & frame
- Stainless steel **FLAVORIZER** bars
- Flush electronic push button ignition system, 1 AA battery included
- Porcelain-enameled lid
- Remote Control Knob Lighting
- **NIGHTVISION** LED grill lighting, 3 C-cell batteries included
- Extra large prep & serve table
- Painted enclosed steel cabinet with painted steel door
- Grill locker
- Pull & clean grease management system
- One grease scraper included
- Visible front tanks scale
- Fuel gauge - LP models only (tank not included)
- Six tool hooks
- Two front locking castors / Two back swivel casters
- Propane tank inside the cabinet
- Natural gas grill includes a 10-foot flexible hose

37810001 **\$1,226.49** \$1,699.00 \$1,949.00

GENESIS EPX-335 GAS GRILL BLACK NG

MASTER CARTON: 1

H: 32.13 W: 30.88 D: 35.75 Wt: 210.0 Cu.Ft.: 20.5

DIMENSIONS - LID CLOSED

H: 48.1 W: 61.5 D: 27.0

DIMENSIONS - LID OPEN

H: 62.1 W: 61.5 D: 30.6



FOB

MAP

MSRP

GENESIS SPX-435 SMART GAS GRILL

36800001 **\$1,501.90** \$2,099.00 \$2,399.00

GENESIS SPX-435 GAS GRILL **STAINLESS STEEL** **LP**

MASTER CARTON: 1

H: 32.38 W: 36.0 D: 38.19 Wt: 248.0 Cu.Ft.: 25.8

DIMENSIONS - LID CLOSED

H: 48.1 W: 68.5 D: 27.0

DIMENSIONS - LID OPEN

H: 62.1 W: 68.5 D: 30.6



- Integrated **WEBER CONNECT** smart grilling technology:
 - Step-by-step grilling assistance
 - Real time food temperature monitoring
 - WiFi connected for remote grill access
 - Low fuel indications on your phone
 - Integrated ambient thermometer to measure temp of the grill

38800001 **\$1,501.90** \$2,099.00 \$2,399.00

GENESIS SPX-435 GAS GRILL **STAINLESS STEEL** **NG**

MASTER CARTON: 1

H: 32.38 W: 36.0 D: 38.19 Wt: 248.0 Cu.Ft.: 25.8

DIMENSIONS - LID CLOSED

H: 48.1 W: 68.5 D: 27.0

DIMENSIONS - LID OPEN

H: 62.1 W: 68.5 D: 30.6



- Digital LED display
- Includes one meat probe, two probe capacity
- Primary cooking area = 646 square inches
- Expandable cooking grate area = 348 square inches
- Total cooking area = 994 square inches
- Four stainless steel burners
- 48,000 BTU-per-hour input main burners
- 12,000 BTU-per-hour input **SEAR ZONE** burner
- 12,000 BTU-per-hour input side burner
- 7mm stainless steel cooking grates
- **WEBER CRAFTED** cooking grates & frame
- Stainless steel **FLAVORIZER** bars
- Flush electronic push button ignition system, 1 AA battery included
- Stainless steel lid
- Remote Control Knob Lighting
- **NIGHTVISION** LED grill lighting, 3 C-cell batteries included
- Extra large prep & serve table
- Stainless steel cabinet with painted steel door
- Grill locker
- Pull & clean grease management system
- One grease scraper included
- Visible front tanks scale
- Fuel gauge - LP models only (tank not included)
- Six tool hooks
- Two front locking castors / Two back swivel casters
- Propane tank inside the cabinet
- Natural gas grill includes a 10-foot flexible hose

GAS GRILLS

FOB

MAP

MSRP

SUMMIT E-470 GAS GRILL

7171001 **\$1,832.61** \$2,649.00 \$2,949.00

SUMMIT E-470 GAS GRILL BLACK LP

MASTER CARTON: 1

H: 52.0 W: 38.0 D: 31.0 Wt: 245.0 Cu.Ft.: 35.4

DIMENSIONS - LID CLOSED

H: 51.0 W: 66.0 D: 27.0

DIMENSIONS - LID OPEN

H: 57.0 W: 66.0 D: 30.0



- Primary cooking area = 468 square inches
- Warming rack area = 112 square inches
- Total cooking area = 580 square inches
- Four stainless steel burners
- 48,800 BTU-per-hour input main burners
- 12,000 BTU-per-hour input, flush-mounted side burner
- 10,600 BTU-per-hour input **SEAR STATION** burner
- 6,800 BTU-per-hour input smoker burner and stainless steel smoker box
- 10,600 BTU-per-hour input, rear-mounted, infrared rotisserie burner
- Tuck-Away rotisserie system with flip-up motor and separate spit and fork storage in the enclosed cart
- 9 mm diameter stainless steel rod cooking grates
- Stainless steel **FLAVORIZER** bars
- **SNAP-JET** individual burner ignition system
- Porcelain-enameled lid with thermometer, polished handle, and painted aluminum end caps
- Enclosed cabinet with painted steel doors and chrome-plated aluminum handles
- Front access, stainless steel grease tray with catch pan
- Lighted control knobs
- LED tank scale display and fuel gauge - LP models only (tank not included)
- One **GRILL 'N GO** handle light
- Six tool hooks
- Two front locking swivel casters and two back swivel casters
- Natural gas grill includes a 10-foot flexible hose

7271001 **\$1,816.22** \$2,649.00 \$2,949.00

SUMMIT E-470 GAS GRILL BLACK NG

MASTER CARTON: 1

H: 52.0 W: 38.0 D: 31.0 Wt: 245.0 Cu.Ft.: 35.4

DIMENSIONS - LID CLOSED

H: 21.0 W: 66.0 D: 27.0

DIMENSIONS - LID OPEN

H: 57.0 W: 66.0 D: 30.0



SUMMIT S-470 GAS GRILL

7170001 **\$1,900.01** \$2,749.00 \$3,049.00

SUMMIT S-470 GAS GRILL STAINLESS STEEL LP

MASTER CARTON: 1

H: 52 W: 38 D: 31 Wt: 245 Cu.Ft.: 35.4

DIMENSIONS - LID CLOSED

H: 51 W: 66 D: 27

DIMENSIONS - LID OPEN

H: 57 W: 66 D: 30



- Primary cooking area = 468 square inches
- Warming rack area = 112 square inches
- Total cooking area = 580 square inches
- Four stainless steel burners
- 48,800 BTU-per-hour input main burners
- 12,000 BTU-per-hour input, flush-mounted side burner
- 10,600 BTU-per-hour input **SEAR STATION** burner
- 6,800 BTU-per-hour input smoker burner and stainless steel smoker box
- 10,600 BTU-per-hour input, rear-mounted, infrared rotisserie burner
- Tuck-Away rotisserie system with flip-up motor and separate spit and fork storage in the enclosed cart
- 9 mm diameter stainless steel rod cooking grates
- Stainless steel **FLAVORIZER** bars
- **SNAP-JET** individual burner ignition system
- Stainless steel lid with thermometer, polished handle, and painted aluminum end caps
- Enclosed cabinets with stainless steel doors and chrome-plated aluminum handles
- Front access, stainless steel grease tray with catch pan
- Lighted control knobs
- LED tank scale display and fuel gauge - LP models only (tank not included)
- One **GRILL 'N GO** handle light
- Six tool hooks
- Two front locking swivel casters and two back swivel casters
- Natural gas grill includes a 10-foot flexible hose

7270001 **\$1,885.10** \$2,749.00 \$3,049.00

SUMMIT S-470 GAS GRILL STAINLESS STEEL NG

MASTER CARTON: 1

H: 52.0 W: 38.0 D: 31.0 Wt: 245.0 Cu.Ft.: 35.4

DIMENSIONS - LID CLOSED

H: 51.0 W: 66.0 D: 27.0

DIMENSIONS - LID OPEN

H: 57.0 W: 66.0 D: 30.0



FOB

MAP

MSRP

SUMMIT E-670 GAS GRILL

7371001	\$2,157.32	\$3,549.00	\$3,849.00
SUMMIT E-670 GAS GRILL	BLACK	LP	
MASTER CARTON: 1			
H: 52.0	W: 46.0	D: 31.0	Wt: 281.0 Cu.Ft.: 43.1
DIMENSIONS - LID CLOSED			
H: 51.0	W: 74.0	D: 27.0	
DIMENSIONS - LID OPEN			
H: 57.0	W: 74.0	D: 30.0	



- Primary cooking area = 624 square inches
- Warming rack area = 145 square inches
- Total cooking area = 769 square inches
- Six stainless steel burners
- 60,000 BTU-per-hour input main burners
- 12,000 BTU-per-hour input, flush-mounted side burner
- 10,600 BTU-per-hour input **SEAR STATION** burner
- 6,800 BTU-per-hour input smoker burner and stainless steel smoker box
- 10,600 BTU-per-hour input, rear-mounted, infrared rotisserie burner
- Tuck-Away rotisserie system with flip-up motor and separate spit and fork storage in the enclosed cart
- 9 mm diameter stainless steel rod cooking grates
- Stainless steel **FLAVORIZER** bars
- **SNAP-JET** individual burner ignition system
- Porcelain-enameled lid with thermometer, polished handle, and painted aluminum end caps
- Enclosed cabinet with painted steel doors and chrome-plated aluminum handles
- Front access, stainless steel grease tray with catch pan
- Lighted control knobs
- LED tank scale display and fuel gauge - LP models only (tank not included)
- Two **GRILL 'N GO** handle light
- Six tool hooks
- Two front locking swivel casters and two back swivel casters
- Natural gas grill includes a 10-foot flexible hose

7471001	\$2,148.24	\$3,549.00	\$3,849.00
SUMMIT E-670 GAS GRILL	BLACK	NG	
MASTER CARTON: 1			
H: 52.0	W: 46.0	D: 31.0	Wt: 281.0 Cu.Ft.: 43.1
DIMENSIONS - LID CLOSED			
H: 51.0	W: 74.0	D: 27.0	
DIMENSIONS - LID OPEN			
H: 57.0	W: 74.0	D: 30.0	



SUMMIT S-670 GAS GRILL

7370001	\$2,221.53	\$3,649.00	\$3,949.00
SUMMIT S-670 GAS GRILL	STAINLESS STEEL	LP	
MASTER CARTON: 1			
H: 52.0	W: 46.0	D: 31.0	Wt: 281.0 Cu.Ft.: 43.1
DIMENSIONS - LID CLOSED			
H: 51.0	W: 74.0	D: 27.0	
DIMENSIONS - LID OPEN			
H: 57.0	W: 74.0	D: 30.0	



- Primary cooking area = 624 square inches
- Warming rack area = 145 square inches
- Total cooking area = 769 square inches
- Six stainless steel burners
- 60,000 BTU-per-hour input main burners
- 12,000 BTU-per-hour input, flush-mounted side burner
- 10,600 BTU-per-hour input **SEAR STATION** burner
- 6,800 BTU-per-hour input smoker burner and stainless steel smoker box
- 10,600 BTU-per-hour input, rear-mounted, infrared rotisserie burner
- Tuck-Away rotisserie system with flip-up motor and separate spit and fork storage in the enclosed cart
- 9 mm diameter stainless steel rod cooking grates
- Stainless steel **FLAVORIZER** bars
- **SNAP-JET** individual burner ignition system
- Stainless steel lid with thermometer, polished handle, and painted aluminum end caps
- Enclosed cabinets with stainless steel doors and chrome-plated aluminum handles
- Front access, stainless steel grease tray with catch pan
- Lighted control knobs
- LED tank scale display and fuel gauge - LP models only (tank not included)
- Two **GRILL 'N GO** handle light
- Six tool hooks
- Two front locking swivel casters and two back swivel casters
- Natural gas grill includes a 10-foot flexible hose

7470001	\$2,207.55	\$3,649.00	\$3,949.00
SUMMIT S-670 GAS GRILL	STAINLESS STEEL	NG	
MASTER CARTON: 1			
H: 52.0	W: 46.0	D: 31.0	Wt: 281.0 Cu.Ft.: 43.1
DIMENSIONS - LID CLOSED			
H: 51.0	W: 74.0	D: 27.0	
DIMENSIONS - LID OPEN			
H: 57.0	W: 74.0	D: 30.0	



GAS GRILLS

FOB

MAP

MSRP

SUMMIT GRILL CENTER

291101 **\$2,882.03** \$4,399.00 \$4,699.00

SUMMIT GRILL CENTER BLACK LP

MASTER CARTON (BOX 1): 1

H: 54.0 W: 30.0 D: 46.0 Wt: 310.0 Cu.Ft.: 42.7

MASTER CARTON (BOX 2): 1

H: 28.0 W: 22.0 D: 36.0 Wt: 108.0 Cu.Ft.: 12.9

DIMENSIONS - LID CLOSED

H: 52.0 W: 91.0 D: 27.0

DIMENSIONS - LID OPEN

H: 59.0 W: 91.0 D: 30.0



292101 **\$2,882.03** \$4,399.00 \$4,699.00

SUMMIT GRILL CENTER BLACK NG

MASTER CARTON (BOX 1): 1

H: 54.0 W: 30.0 D: 46.0 Wt: 310.0 Cu.Ft.: 42.7

MASTER CARTON (BOX 2): 1

H: 28.0 W: 22.0 D: 36.0 Wt: 108.0 Cu.Ft.: 12.9

DIMENSIONS - LID CLOSED

H: 52.0 W: 91.0 D: 27.0

DIMENSIONS - LID OPEN

H: 59.0 W: 91.0 D: 30.0



291001 **\$2,945.97** \$4,499.00 \$4,799.00

SUMMIT GRILL CENTER STAINLESS STEEL LP

MASTER CARTON (BOX 1): 1

H: 54.0 W: 30.0 D: 46.0 Wt: 310.0 Cu.Ft.: 42.7

MASTER CARTON (BOX 2): 1

H: 28.0 W: 22.0 D: 36.0 Wt: 108.0 Cu.Ft.: 12.9

DIMENSIONS - LID CLOSED

H: 52.0 W: 91.0 D: 27.0

DIMENSIONS - LID OPEN

H: 59.0 W: 91.0 D: 30.0



- Primary cooking area = 624 square inches
- Warming rack area = 145 square inches
- Total cooking area = 769 square inches
- Six stainless steel burners
- 60,000 BTU-per-hour input main burners
- 27,000 BTU-per-hour input, dual ring, flush-mounted side burner
- 10,600 BTU-per-hour input **SEAR STATION** burner
- 6,800 BTU-per-hour input smoker burner and stainless steel smoker box
- 10,600 BTU-per-hour input, rear-mounted, infrared rotisserie burner
- Tuck-Away rotisserie system with flip-up motor and separate spit and fork storage
- 9 mm diameter stainless steel rod cooking grates
- Stainless steel **FLAVORIZER** bars
- **SNAP-JET** individual burner ignition system
- Two extra large stainless steel work surfaces
- Stainless steel control panel with cast aluminum end caps
- Enclosed tank storage area
- Four adjustable stainless steel wire shelves
- Stainless steel paper towel holder
- Eight adjustable steel legs
- Front access, stainless steel grease tray with catch pan
- Lighted control knobs
- LED tank scale display and fuel gauge (LP models only)
- Two **GRILL 'N GO** handle light
- Six tool hooks
- Natural gas grill includes a 10-foot flexible hose
- Tank not included with LP models

BLACK

- Porcelain-enameled lid with thermometer, polished handle, and painted aluminum end caps
- Two enclosed cabinets with painted steel doors and chrome-plated aluminum handles

STAINLESS

- Stainless steel lid with thermometer, polished handle, and painted aluminum end caps
- Two enclosed storage areas with stainless steel doors and chrome-plated aluminum handles

292001 **\$2,945.97** \$4,499.00 \$4,799.00

SUMMIT GRILL CENTER STAINLESS STEEL NG

MASTER CARTON (BOX 1): 1

H: 54.0 W: 30.0 D: 46.0 Wt: 310.0 Cu.Ft.: 42.7

MASTER CARTON (BOX 2): 1

H: 28.0 W: 22.0 D: 36.0 Wt: 108.0 Cu.Ft.: 12.9

DIMENSIONS - LID CLOSED

H: 52.0 W: 91.0 D: 27.0

DIMENSIONS - LID OPEN

H: 59.0 W: 91.0 D: 30.0



FOB

MAP

MSRP

SUMMIT S-460 BUILT-IN GAS GRILL

7160001 **\$2,042.21** \$2,999.00 \$3,299.00

SUMMIT S-460 BUILT-IN GAS GRILL STAINLESS STEEL LP

MASTER CARTON: 1

H: 52.0 W: 39.0 D: 31.0 Wt: 245.0 Cu.Ft.: 35.4

DIMENSIONS - LID CLOSED

H: 51.0 W: 34.0 D: 31.0

DIMENSIONS - LID OPEN

H: 58.0 W: 34.0 D: 31.0



- Primary cooking area = 468 square inches
- Warming rack area = 112 square inches
- Total cooking area = 580 square inches
- Four stainless steel burners
- 48,800 BTU-per-hour input main burners
- 10,600 BTU-per-hour input, rear-mounted, infrared rotisserie burner
- 10,600 BTU-per-hour input **SEAR STATION** burner
- 6,800 BTU-per-hour input smoker burner and stainless steel smoker box
- 9 mm diameter stainless steel rod cooking grates
- Stainless steel **FLAVORIZER** bars
- **SNAP-JET** individual burner ignition system
- Stainless steel lid with thermometer, polished handle, and painted aluminum end caps
- Enclosed cabinet with stainless steel doors
- Front access, stainless steel grease tray with catch pan
- SlideFrame design
- Two swivel casters and two locking casters provide easy installation and serviceability; a stainless steel panel discreetly hides them until they are needed
- Lighted control knobs
- Premium cover included
- One **GRILL 'N GO** handle light

Island not included

7260001 **\$2,042.21** \$2,999.00 \$3,299.00

SUMMIT S-460 BUILT-IN GAS GRILL STAINLESS STEEL NG

MASTER CARTON: 1

H: 52.0 W: 39.0 D: 31.0 Wt: 245.0 Cu.Ft.: 35.4

DIMENSIONS - LID CLOSED

H: 51.0 W: 34.0 D: 31.0

DIMENSIONS - LID OPEN

H: 58.0 W: 34.0 D: 31.0



SUMMIT S-660 BUILT-IN GAS GRILL

7360001 **\$2,247.34** \$3,749.00 \$4,049.00

SUMMIT S-660 BUILT-IN GAS GRILL STAINLESS STEEL LP

MASTER CARTON: 1

H: 52.0 W: 46.0 D: 31.0 Wt: 289.0 Cu.Ft.: 43.1

DIMENSIONS - LID CLOSED

H: 51.0 W: 42.0 D: 31.0

DIMENSIONS - LID OPEN

H: 58.0 W: 42.0 D: 31.0



- Primary cooking area = 624 square inches
- Warming rack area = 145 square inches
- Total cooking area = 769 square inches
- Six stainless steel burners
- 60,000 BTU-per-hour input main burners
- 10,600 BTU-per-hour input, rear-mounted, infrared rotisserie burner
- 10,600 BTU-per-hour input **SEAR STATION** burner
- 6,800 BTU-per-hour input smoker burner and stainless steel smoker box
- 9 mm diameter stainless steel rod cooking grates
- Stainless steel **FLAVORIZER** bars
- **SNAP-JET** individual burner ignition system
- Stainless steel lid with thermometer, polished handle, and painted aluminum end caps
- Enclosed cabinet with stainless steel doors
- Front access, stainless steel grease tray with catch pan
- SlideFrame design
- Two swivel casters and two locking casters provide easy installation and serviceability; a stainless steel panel discreetly hides them until they are needed
- Lighted control knobs
- Premium cover included
- Two **GRILL 'N GO** handle light

Island not included

7460001 **\$2,247.34** \$3,749.00 \$4,049.00

SUMMIT S-660 BUILT-IN GAS GRILL STAINLESS STEEL NG

MASTER CARTON: 1

H: 52.0 W: 46.0 D: 31.0 Wt: 289.0 Cu.Ft.: 43.1

DIMENSIONS - LID CLOSED

H: 51.0 W: 42.0 D: 31.0

DIMENSIONS - LID OPEN

H: 58.0 W: 42.0 D: 31.0



PORTABLE GRILLS

FOB

MAP

MSRP

SMOKEY JOE CHARCOAL GRILL

10020 **\$35.82** \$45.99 \$50.99

SMOKEY JOE CHARCOAL GRILL 14 INCH BLACK

MASTER CARTON: 4

H: 18.1 W: 15.4 D: 32.8 Wt: 37.7 Cu.Ft.: 5.3

DIMENSIONS

H: 17.0 W: 14.2 D: 14.5



- Cooking area = 147 square inches
- Plated steel cooking grate
- Porcelain-enameled bowl and lid
- Rust-resistant aluminum damper
- One glass-reinforced nylon handle
- Aluminum ash catcher

SMOKEY JOE PREMIUM CHARCOAL GRILL

40020 **\$42.21** \$57.00 \$67.00

SMOKEY JOE PREMIUM CHARCOAL GRILL 14 INCH BLACK

MASTER CARTON: 4

H: 18.1 W: 16.9 D: 16.2 Wt: 39.3 Cu.Ft.: 5.3

DIMENSIONS

H: 17.0 W: 14.2 D: 16.5



- Cooking area = 147 square inches
- Plated steel cooking grate
- Porcelain-enameled bowl and lid
- Rust-resistant aluminum damper
- One glass-reinforced nylon handle
- **TUCK-N-CARRY** lid lock doubles as a carry handle and lid holder

1126801 **\$49.66** \$67.00 \$77.00

SMOKEY JOE PREMIUM CHARCOAL GRILL 14 INCH SLATE BLUE

MASTER CARTON: 4

H: 18.1 W: 16.9 D: 16.2 Wt: 39.3 Cu.Ft.: 5.3

DIMENSIONS

H: 17.0 W: 14.2 D: 16.5



- Cooking area = 240 square inches
- Plated steel cooking grate
- Porcelain-enameled bowl and lid
- Rust-resistant aluminum dampers
- Rust-resistant aluminum ash catcher
- Lid handle with heat shield
- **TUCK-N-CARRY** lid lock doubles as a carry handle and lid holder

JUMBO JOE CHARCOAL GRILL

1211001 **\$62.49** \$89.00 \$99.00

JUMBO JOE CHARCOAL GRILL 18 INCH BLACK

MASTER CARTON: 1

H: 8.8 W: 19.5 D: 19.5 Wt: 18.0 Cu.Ft.: 2.0

DIMENSIONS

H: 19.7 W: 20.5 D: 19.7



- Cooking area = 240 square inches
- Plated steel cooking grate
- Porcelain-enameled bowl and lid
- Rust-resistant aluminum dampers
- Rust-resistant aluminum ash catcher
- Lid handle with heat shield
- **TUCK-N-CARRY** lid lock doubles as a carry handle and lid holder

FOB

MAP

MSRP

GO-ANYWHERE CHARCOAL GRILL

121020 **\$52.10** \$71.00 \$81.00

GO-ANYWHERE CHARCOAL GRILL

BLACK

MASTER CARTON: 4

H: 14.5 W: 21.0 D: 12.2 Wt: 56.9 Cu.Ft.: 5.9

DIMENSIONS

H: 15.0 W: 19.5 D: 11.5



- Cooking area = 160 square inches
- Plated steel cooking grate
- Porcelain-enameled base and lid
- Rust-resistant aluminum dampers
- Three glass-reinforced nylon handles
- Plated steel legs pivot to lock lid in place for carrying

GO-ANYWHERE GAS GRILL

1141001 **\$65.74** \$89.00 \$99.00

GO-ANYWHERE GAS GRILL

BLACK

MASTER CARTON: 4

H: 14.5 W: 21.0 D: 12.2 Wt: 56.9 Cu.Ft.: 5.9

DIMENSIONS

H: 15.0 W: 19.5 D: 11.5



- Cooking area = 160 square inches
- One stainless steel burner
- 6,500 BTU-per-hour input main burner
- Porcelain-enameled cooking grate
- Porcelain-enameled base and lid
- Three glass-reinforced nylon handles
- Plated steel legs pivot to lock lid in place for carrying
- Push-button igniter
- Uses disposable 14.1 oz. LP cylinders (not included)

CHARCOAL GRILLS

FOB

MAP

MSRP

ORIGINAL KETTLE CHARCOAL GRILL

441001

\$79.69

\$119.00

\$129.00

ORIGINAL KETTLE CHARCOAL GRILL

18 INCH BLACK

MASTER CARTON: 1

H: 14.8 W: 20.5 D: 20.5 Wt: 21.0 Cu.Ft.: 3.5

DIMENSIONS

H: 36.0 W: 23.0 D: 18.5



741001

\$97.40

\$139.00

\$149.00

ORIGINAL KETTLE CHARCOAL GRILL

22 INCH BLACK

MASTER CARTON: 1

H: 15.0 W: 24.5 D: 24.5 Wt: 37.0 Cu.Ft.: 5.1

DIMENSIONS

H: 39.5 W: 25.0 D: 22.5



- 18 inch cooking area = 240 square inches
- 22 inch cooking area = 363 square inches
- Plated steel cooking grate
- Porcelain-enameled bowl and lid
- Aluminized steel **ONE-TOUCH** cleaning system
- Rust-resistant ash catcher
- Rust-resistant aluminum damper
- Glass-reinforced nylon bowl handle
- Glass-reinforced nylon lid handle with heat shield
- Spring clip/push pin leg assembly
- Durable all-weather wheels
- Angled lid hook inside grill lid

FOB

MAP

MSRP

ORIGINAL KETTLE PREMIUM CHARCOAL GRILL

14401001	\$148.42	\$219.00	\$269.00
ORIGINAL KETTLE PREMIUM CHARCOAL GRILL 22 INCH BLACK			
MASTER CARTON: 1			
H: 15.0	W: 24.5	D: 24.5	Wt: 37.0 Cu.Ft.: 5.1
DIMENSIONS			
H: 39.5	W: 27.0	D: 22.5	



- Cooking area = 363 square inches
- Plated steel, hinged cooking grate
- Porcelain-enameled bowl and lid
- Aluminized steel **ONE-TOUCH** cleaning system
- Removable, high-capacity, aluminum ash catcher
- Rust-resistant aluminum damper
- Glass-reinforced nylon bowl handles with tool hooks
- Glass-reinforced nylon lid handle with heat shield
- Spring clip/push pin leg assembly
- Durable all-weather wheels
- Angled lid hook inside grill lid
- Built-in lid thermometer

COLORS	\$161.84	\$239.00	\$289.00
---------------	-----------------	----------	----------

14402001
COPPER

14407001
GREEN

CHARCOAL GRILLS

FOB

MAP

MSRP

ORIGINAL KETTLE PREMIUM CHARCOAL GRILL

16401001

\$326.44

\$429.00

\$529.00

ORIGINAL KETTLE PREMIUM CHARCOAL GRILL

26 INCH

BLACK

MASTER CARTON: 1

H: 19.0 W: 30.0 D: 30.0 Wt: 63.0 Cu.Ft.: 9.9

DIMENSIONS

H: 42.3 W: 32.0 D: 24.4



- Cooking area = 508 square inches
- Stainless steel hinged cooking grate
- Porcelain-enameled bowl and lid
- Stainless steel **ONE-TOUCH** cleaning system
- Removable, high-capacity, aluminum ash catcher
- Rust-resistant aluminum damper
- Glass-reinforced nylon bowl handle with tool hooks
- Glass-reinforced nylon lid handle with heat shield
- Spring clip/push pin leg assembly
- Durable all-weather 8 inch rubber molded wheels
- **TUCK-AWAY** lid holder
- Two **CHAR-BASKET** charcoal fuel holders
- Built-in lid thermometer

CHARCOAL GRILLS

FOB

MAP

MSRP

MASTER-TOUCH CHARCOAL GRILL

14501001 **\$183.95** \$275.00 \$325.00

MASTER-TOUCH CHARCOAL GRILL 22 INCH BLACK

MASTER CARTON: 1

H: 15.0 W: 24.5 D: 24.5 Wt: 47.0 Cu.Ft.: 5.1

DIMENSIONS - LID CLOSED

H: 42.0 W: 24.0 D: 29.5



COLORS **\$199.94** \$299.00 \$349.00

14516001

DEEP OCEAN BLUE



14505601

IVORY



14510601

SMOKE



14511601

SPRING GREEN



14513601

SLATE



- Primary cooking area = 363 square inches
- Warming rack area = 80 square inches
- Total cooking area = 443 square inches
- **GOURMET BBQ SYSTEM** hinged cooking grate
- Porcelain-enameled bowl and lid
- Aluminized steel **ONE-TOUCH** cleaning system
- Removable, high-capacity, aluminum ash catcher
- Rust-resistant aluminum damper
- Glass-reinforced nylon bowl handle with tool hooks
- Glass-reinforced nylon lid handle with heat shield
- Spring clip/push pin leg assembly
- Durable all-weather 8 inch rubber molded wheels
- **TUCK-AWAY** lid holder
- Two **CHAR-BASKET** charcoal fuel holders
- Built-in lid thermometer

CHARCOAL GRILLS

FOB

MAP

MSRP

PERFORMER CHARCOAL GRILL

15301001

\$247.07

\$349.00

\$449.00

PERFORMER CHARCOAL GRILL

22 INCH BLACK

MASTER CARTON: 1

H: 17.5 W: 32.3 D: 27.0 Wt: 70.0 Cu.Ft.: 8.7

DIMENSIONS - LID CLOSED

H: 43.5 W: 42.0 D: 29.0



- Cooking area = 363 square inches
- **GOURMET BBQ SYSTEM** hinged cooking grate
- Porcelain-enameled bowl and lid
- Aluminized steel **ONE-TOUCH** cleaning system
- Removable, high-capacity, aluminum ash catcher
- **TUCK-AWAY** lid holder
- Rust-resistant aluminum damper
- Lid handle with heat shield
- Painted, metal fold-down table
- Heavy-duty steel cart frame
- Three tool hooks
- Built-in lid thermometer
- Wire bottom shelf
- Two durable all-weather wheels with full wheel hubs
- Two locking casters

PERFORMER PREMIUM CHARCOAL GRILL

15401001

\$327.62

\$499.00

\$599.00

PERFORMER PREMIUM CHARCOAL GRILL

22 INCH BLACK

MASTER CARTON: 1

H: 20.3 W: 38.8 D: 27.3 Wt: 95.0 Cu.Ft.: 12.3

DIMENSIONS - LID CLOSED

H: 44.1 W: 48.0 D: 30.0



- Cooking area = 363 square inches
- **GOURMET BBQ SYSTEM** hinged cooking grate
- Porcelain-enameled bowl and lid
- Aluminized steel **ONE-TOUCH** cleaning system
- Removable, high-capacity, aluminum ash catcher
- **TUCK-AWAY** lid holder
- Rust-resistant aluminum damper
- Lid handle with heat shield
- Removable backlit LCD cook timer
- Two **CHAR-BASKET** charcoal fuel holders
- Painted, metal work table
- Heavy-duty steel cart frame
- Three tool hooks
- Built-in lid thermometer
- Weather-protected **CHARBIN** storage container
- Wire bottom shelf
- Two durable all-weather 8 inch rubber molded wheels
- Two locking casters

FOB

MAP

MSRP

PERFORMER DELUXE CHARCOAL GRILL

15501001 **\$369.31** \$549.00 \$649.00

PERFORMER DELUXE CHARCOAL GRILL 22 INCH BLACK

MASTER CARTON: 1

H: 20.3 W: 38.8 D: 27.3 Wt: 99.0 Cu.Ft.: 12.3

DIMENSIONS - LID CLOSED

H: 44.1 W: 48.0 D: 30.0



15502001 **\$389.50** \$579.00 \$679.00

PERFORMER DELUXE CHARCOAL GRILL 22 INCH COPPER

MASTER CARTON: 1

H: 20.3 W: 38.8 D: 27.3 Wt: 99.0 Cu.Ft.: 12.3

DIMENSIONS - LID CLOSED

H: 44.1 W: 48.0 D: 30.0



15507001 **\$389.50** \$579.00 \$679.00

PERFORMER DELUXE CHARCOAL GRILL 22 INCH GREEN

MASTER CARTON: 1

H: 20.3 W: 38.8 D: 27.3 Wt: 99.0 Cu.Ft.: 12.3

DIMENSIONS - LID CLOSED

H: 44.1 W: 48.0 D: 30.0



- Cooking area = 363 square inches
- **GOURMET BBQ SYSTEM** hinged cooking grate
- Electronic **TOUCH-N-GO** gas ignition system
- Porcelain-enameled bowl and lid
- Aluminized steel **ONE-TOUCH** cleaning system
- Removable, high-capacity, aluminum ash catcher
- **TUCK-AWAY** lid holder
- Rust-resistant aluminum damper
- Lid handle with heat shield
- Removable backlit LCD cook timer
- Two **CHAR-BASKET** charcoal fuel holders
- Painted, metal work table
- Heavy-duty steel cart frame
- Three tool hooks
- Built-in lid thermometer
- Weather-protected **CHARBIN** storage container
- Wire bottom shelf
- Two durable all-weather 8 inch rubber molded wheels
- Two locking casters
- Uses disposable 14.1 or 16.4 oz. LP cylinders (sold separately)

CHARCOAL GRILLS

FOB

MAP

MSRP

SUMMIT KAMADO E6 GRILL

18201001

\$802.17

\$1,249.00

\$1,449.00

SUMMIT KAMADO E6 CHARCOAL GRILL

24 INCH BLACK

MASTER CARTON: 1

H: 29.3 W: 36.8 D: 30.6 Wt: 142.0 Cu.Ft.: 18.7

DIMENSIONS - LID CLOSED

H: 44.9 W: 34.8 D: 35.8

DIMENSIONS - LID OPEN

H: 59.4 W: 34.8 D: 35.8



- Cooking area = 452 square inches
- **GOURMET BBQ SYSTEM** stainless steel hinged cooking grate
- Stainless steel diffuser plate
- Two position fuel grate
- Air-insulated double-walled porcelain-enameled lid and bowl
- **RAPIDFIRE** lid damper
- Lid thermometer
- Easy open lid hinge
- Stainless steel **ONE-TOUCH** cleaning system
- Removable, high-capacity, aluminum ash catcher
- Smoke/low and slow vent setting
- Two **CHAR-BASKET** charcoal fuel holders
- Two tool hooks
- Bottom wire rack & diffuser plate storage area
- Two swivel casters
- One locking caster

SUMMIT KAMADO S6 GRILL CENTER GRILL

18501101

\$1,372.40

\$2,149.00

\$2,449.00

SUMMIT KAMADO S6 CHARCOAL GRILL

24 INCH BLACK

MASTER CARTON: 1

H: 35.0 W: 57.0 D: 30.5 Wt: 238.0 Cu.Ft.: 32.4

DIMENSIONS - LID CLOSED

H: 47.7 W: 56.6 D: 35.0

DIMENSIONS - LID OPEN

H: 62.2 W: 56.6 D: 35.0



- Cooking area = 452 square inches
- **GOURMET BBQ SYSTEM** stainless steel hinged cooking grate
- Stainless steel diffuser plate
- Two position fuel grate
- **SNAP-JET** gas ignition system
- Air-insulated double-walled porcelain-enameled lid and bowl
- **RAPIDFIRE** lid damper
- Lid thermometer
- Easy open lid hinge
- Stainless steel **ONE-TOUCH** cleaning system
- Removable, high-capacity, aluminum ash catcher
- Smoke/low and slow vent setting
- Two **CHAR-BASKET** charcoal fuel holders
- Stainless steel tabletop
- Stainless steel wire basket
- Three stainless steel tool hooks
- Fuel Bag included
- Bottom wire rack
- Diffuser plate storage area
- Two durable all-weather 8 inch rubber molded wheels
- Two locking casters
- Uses disposable 14.1 or 16.4 oz. LP cylinders (sold separately)

FOB

MAP

MSRP

SMOKEY MOUNTAIN COOKER SMOKER

711001	\$194.58	\$279.00	\$329.00
SMOKEY MOUNTAIN COOKER SMOKER		14 INCH BLACK	
MASTER CARTON: 1			
H: 23.5	W: 18.0	D: 17.8	Wt: 29.0 Cu.Ft.: 4.5
DIMENSIONS			
H: 31.4	W: 14.7	D: 14.7	



721001	\$266.07	\$419.00	\$519.00
SMOKEY MOUNTAIN COOKER SMOKER		18 INCH BLACK	
MASTER CARTON: 1			
H: 29.5	W: 21.8	D: 21.5	Wt: 51.0 Cu.Ft.: 8.2
DIMENSIONS			
H: 41.7	W: 19.7	D: 19.7	



731001	\$334.99	\$549.00	\$649.00
SMOKEY MOUNTAIN COOKER SMOKER		22 INCH BLACK	
MASTER CARTON: 1			
H: 35.0	W: 27.0	D: 26.5	Wt: 78.0 Cu.Ft.: 13.8
DIMENSIONS			
H: 48.5	W: 23.0	D: 24.0	



- 14 inch cooking area = 286 square inches
- 18 inch cooking area = 481 square inches
- 22 inch cooking area = 726 square inches
- Two plated steel cooking grates
- Porcelain-enameled bowl, lid, center section, and water pan
- Charcoal chamber
- Built-in lid thermometer
- Silicone temperature grommet
- Four rust-resistant aluminum dampers
- Rust-resistant aluminum fuel door
- Glass-reinforced nylon handle(s)
- Rust-resistant aluminum heat shield
- Cover included

RANCH KETTLE

60020	\$1,078.63	\$1,849.00	\$2,099.00
RANCH KETTLE		37 INCH BLACK	
MASTER CARTON: 1			
H: 19.0	W: 42.3	D: 42.0	Wt: 152.0 Cu.Ft.: 19.9
DIMENSIONS			
H: 42.0	W: 37.7	D: 44.7	



- Cooking area = 1,104 square inches
- Stainless steel hinged cooking grate
- Porcelain-enameled bowl and lid
- **TUCK-AWAY** lid holder
- Rust-resistant aluminum dampers
- Removable ash catcher
- Heavy-duty steel cart
- Two glass-reinforced nylon handles
- Two locking casters
- Two durable all-weather wheels with full wheel hubs











ACCESSORIES

FOB

MAP

MSRP

COOKING: SMART GRILLING



<p>3201 WEBER CONNECT SMART GRILLING HUB</p> 	<ul style="list-style-type: none"> Compatible with any grill One meat probe, one ambient probe included Four probe capacity USB rechargeable battery WiFi and Bluetooth® enabled Free iOS & Android app 9 Segmented LED Display Embedded magnet 	<p>\$91.94 \$139.99 \$149.99</p> <p>MASTER CARTON: 4</p> <p>H: 6.38 W: 6.0 D: 12.8 Wt: 4.0 Cu.Ft.: 0.28</p> <p>INDIVIDUAL CARTON:</p> <p>H: 5.52 W: 5.52 D: 2.8 Wt: 1.0</p> <p>OUT OF CARTON:</p> <p>H: 3.9 W: 2.9 D: 1.4</p>	
<p>3250 WEBER CONNECT STORAGE AND TRAVEL CASE</p> 	<ul style="list-style-type: none"> Stores WEBER CONNECT Hub and accessories Shockproof EVA foam interior provides secure fit and protection Durable exterior material is stain resistant and dust proof 	<p>\$23.51 \$40.49 \$45.49</p> <p>MASTER CARTON: 4</p> <p>H: 10.25 W: 9.06 D: 12.2 Wt: 4.03 Cu.Ft.: 0.65</p> <p>INDIVIDUAL CARTON:</p> <p>H: 8.9 W: 8.46 D: 2.95 Wt: 0.84</p> <p>OUT OF CARTON:</p> <p>H: 8.8 W: 9.0 D: 2.8</p>	
<p>3254 WEBER CONNECT 6-PIECE MOUNTING KIT</p> 	<ul style="list-style-type: none"> Attachment kit for mounting WEBER CONNECT Hub to charcoal, smokers and gas grills Keep WEBER CONNECT Hub close-by while grilling Includes bag for convenient storage 	<p>\$23.51 \$40.49 \$45.49</p> <p>MASTER CARTON: 4</p> <p>H: 6.3 W: 5.63 D: 8.27 Wt: 2.45 Cu.Ft.: 0.16</p> <p>INDIVIDUAL CARTON:</p> <p>H: 5.58 W: 5.24 D: 1.97 Wt: 0.73</p> <p>OUT OF CARTON:</p> <p>H: 6.75 W: 6.25 D: 1.5</p>	
<p>7202 iGRILL MINI</p> 	<ul style="list-style-type: none"> App-connected thermometer Bluetooth® smart connection Single probe capability (one Meat Probe included) Smart LED 150-hour battery life (battery included) Hand wash only 	<p>\$39.37 \$54.99</p> <p>MASTER CARTON: 5</p> <p>H: 8.23 W: 4.37 D: 13.51 Wt: 3.0 Cu.Ft.: 0.28</p> <p>INDIVIDUAL CARTON:</p> <p>H: 7.4 W: 3.86 D: 2.56 Wt: 0.45</p> <p>OUT OF CARTON:</p> <p>H: 2 W: 1.6 D: 1.5</p>	
<p>7203 iGRILL 2</p> 	<ul style="list-style-type: none"> App-connected thermometer Bluetooth® smart connection Four probe capability (two Meat Probes included) LED temperature read out 200-hour battery life (batteries included) Hand wash only 	<p>\$84.74 \$109.99</p> <p>MASTER CARTON: 5</p> <p>H: 9.65 W: 7.75 D: 14.4 Wt: 6.0 Cu.Ft.: 0.62</p> <p>INDIVIDUAL CARTON:</p> <p>H: 7.19 W: 8.86 D: 2.75 Wt: 1.0</p> <p>OUT OF CARTON:</p> <p>H: 2.2 W: 3.2 D: 2.2</p>	



FOB

MAP



MSRP

COOKING: SMART GRILLING

7211	MEAT TEMPERATURE PROBE	\$12.79		\$16.49			
 <ul style="list-style-type: none"> • Monitors the internal temperature of your food as it grills • One meat temperature probe included • Four color-coded sleeves included • Hand wash only • Stainless steel • Compatible with iGRILL and WEBER CONNECT devices 	MASTER CARTON: 5	H: 8.0	W: 5.38	D: 5.57		Wt: 1.35	Cu.Ft.: 0.14
	INDIVIDUAL CARTON:	H: 7.32	W: 4.57	D: 0.82		Wt: 0.18	
	OUT OF CARTON:	H: 2.6	W: 0.5	D: 5.0			

7212	AMBIENT TEMPERATURE PROBE	\$12.79		\$16.49			
 <ul style="list-style-type: none"> • Monitors the ambient temperature of the inside of your grill • One ambient temperature probe included • Four color-coded sleeves included • Probe clip included • Hand wash only • Stainless steel • Compatible with iGRILL and WEBER CONNECT devices 	MASTER CARTON: 5	H: 8.0	W: 5.38	D: 5.88		Wt: 1.35	Cu.Ft.: 0.14
	INDIVIDUAL CARTON:	H: 7.32	W: 4.57	D: 0.82		Wt: 0.18	
	OUT OF CARTON:	H: 2.6	W: 0.5	D: 4.3			

COOKING: THERMOMETERS

6750	INSTANT READ THERMOMETER	\$10.78	\$16.99	\$19.99			
 <ul style="list-style-type: none"> • Fast, accurate readings in Fahrenheit or Celsius 	MASTER CARTON: 6	H: 9.88	W: 3.46	D: 9.8		Wt: 1.2	Cu.Ft.: 0.19
	INDIVIDUAL CARTON:	H: 8.75	W: 2.94	D: 1.47		Wt: 0.14	
	OUT OF CARTON:	H: 8.0	W: 1.3	D: 0.3			













ACCESSORIES

FOB

MAP

MSRP

COOKING: GRILLING TOOLS







6320	GRILLING SKEWER SET	\$6.16	\$10.49	\$13.49	
 <ul style="list-style-type: none"> • Set of 8 skewers • Dual-pronged design to prevent food from turning • Easily pierces food without damage • Hand wash only 		MASTER CARTON: 6 H: 13.88 W: 5.57 D: 4.32 Wt: 3.17 Cu.Ft.: 0.19 INDIVIDUAL CARTON: H: 13.1 W: 2.5 D: 1.3 Wt: 0.5 OUT OF CARTON: H: 13.0 W: 1.25 D: 1.0			
6768	PRECISION GRILL TONGS	\$11.53	\$21.49	\$24.49	
 <ul style="list-style-type: none"> • Flat, front edge design for precision control and better handling of food • Durable, stainless steel construction • Soft-touch handle for non-slip grip • Hands-free locking mechanism for ease of use and compact storage • Dishwasher safe for easy cleaning • Metal loop allows hanging storage • 2-year warranty 		MASTER CARTON: 4 H: 24.53 W: 5.04 D: 10.24 Wt: 5.55 Cu.Ft.: 0.73 INDIVIDUAL CARTON: H: 22.84 W: 4.26 D: 1.78 Wt: 0.94 OUT OF CARTON: H: 18.0 W: 1.73 D: 2.0			
6769	PRECISION GRILL SPATULA	\$10.69	\$19.99	\$22.99	
 <ul style="list-style-type: none"> • 3-sided beveled edge design for easy approach and precision flip • Durable, stainless steel construction • Soft-touch handle designed for non-slip grip • Dishwasher safe for easy cleaning • Metal loop allows hanging storage • 2-year warranty 		MASTER CARTON: 4 H: 20.68 W: 6.19 D: 12.09 Wt: 5.71 Cu.Ft.: 0.9 INDIVIDUAL CARTON: H: 19.69 W: 5.82 D: 2.17 Wt: 0.96 OUT OF CARTON: H: 18.0 W: 4.25 D: 2.13			
6770	PRECISION WIDE GRILL SPATULA	\$15.18	\$26.99	\$31.99	
 <ul style="list-style-type: none"> • 3-sided beveled edge design for easy approach and precision flip • Durable, stainless steel construction • Soft-touch handle designed for non-slip grip • Dishwasher safe for easy cleaning • Metal loop allows hanging storage • 2-year warranty 		MASTER CARTON: 4 H: 20.99 W: 8.04 D: 12.41 Wt: 6.99 Cu.Ft.: 1.21 INDIVIDUAL CARTON: H: 19.69 W: 7.29 D: 2.17 Wt: 1.04 OUT OF CARTON: H: 18.0 W: 6.5 D: 2.3			
6771	PRECISION GRILL TONGS & SPATULA SET	\$21.42	\$40.49	\$45.49	
 <ul style="list-style-type: none"> • Includes Precision Grill Tongs and Spatula • Designed for precision control and better handling of food • 3-sided beveled edge design for easy approach and precision flip • Hands-free locking tongs for ease of use and compact storage • Durable, stainless steel construction • Soft-touch handle designed for non-slip grip • Dishwasher safe for easy cleaning • Metal loop allows hanging storage • 2-year warranty 		MASTER CARTON: 4 H: 24.53 W: 8.86 D: 12.21 Wt: 10.07 Cu.Ft.: 1.54 INDIVIDUAL CARTON: H: 22.84 W: 8.23 D: 2.17 Wt: 1.85 OUT OF CARTON: (Spatula) H: W: D: (Tongs) H: W: D:			
6772	PRECISION 3-PIECE GRILL TOOL SET	\$26.33	\$46.99	\$51.99	
 <ul style="list-style-type: none"> • Includes Precision Grill Tongs, Spatula and Basting Brush • Designed for precision control and better handling of food • 3-sided beveled edge design for easy approach and precision flip • Hands-free locking tongs for ease of use and compact storage • Full-size silicone basting brush • Soft-touch handle designed for non-slip grip • Dishwasher safe for easy cleaning • Metal loop allows hanging storage • 2-year warrant 		MASTER CARTON: 4 H: 24.53 W: 11.42 D: 12.21 Wt: 11.85 Cu.Ft.: 1.98 INDIVIDUAL CARTON: H: 22.84 W: 10.64 D: 2.17 Wt: 2.28 OUT OF CARTON: Spatula: Tongs: Brush:			

FOB





MAP

MSRP

COOKING: GRILLING TOOLS

6645 PREMIUM TOOL SET	 <ul style="list-style-type: none"> • Compact size is perfect for camping, picnics, and urban dwellers • Set includes spatula and locking tongs • Stainless steel 	<table border="1"> <tr> <td>\$19.55</td> <td>\$33.49</td> <td>\$38.49</td> </tr> <tr> <td colspan="3">MASTER CARTON: 4</td> </tr> <tr> <td>H: 12.25</td> <td>W: 6.63</td> <td>D: 18.19</td> </tr> <tr> <td>Wt: 7.6</td> <td colspan="2">Cu.Ft.: 0.85</td> </tr> <tr> <td colspan="3">INDIVIDUAL CARTON:</td> </tr> <tr> <td>H: 17.75</td> <td>W: 5.9</td> <td>D: 2.75</td> </tr> <tr> <td>Wt: 1.89</td> <td colspan="2"></td> </tr> <tr> <td colspan="3">OUT OF CARTON:</td> </tr> <tr> <td>(Spatula) H: 14</td> <td>W: 3.3</td> <td>D: 1.2</td> </tr> <tr> <td>(Tongs) H: 15</td> <td>W: 3</td> <td>D: 1.6</td> </tr> </table>	\$19.55	\$33.49	\$38.49	MASTER CARTON: 4			H: 12.25	W: 6.63	D: 18.19	Wt: 7.6	Cu.Ft.: 0.85		INDIVIDUAL CARTON:			H: 17.75	W: 5.9	D: 2.75	Wt: 1.89			OUT OF CARTON:			(Spatula) H: 14	W: 3.3	D: 1.2	(Tongs) H: 15	W: 3	D: 1.6	 <p>0 77924 01119 1</p>
\$19.55	\$33.49	\$38.49																															
MASTER CARTON: 4																																	
H: 12.25	W: 6.63	D: 18.19																															
Wt: 7.6	Cu.Ft.: 0.85																																
INDIVIDUAL CARTON:																																	
H: 17.75	W: 5.9	D: 2.75																															
Wt: 1.89																																	
OUT OF CARTON:																																	
(Spatula) H: 14	W: 3.3	D: 1.2																															
(Tongs) H: 15	W: 3	D: 1.6																															
6707 DELUXE TOOL SET	 <ul style="list-style-type: none"> • Ergonomic design and soft-touch grip provide excellent control • Hands-free locking tongs • Set includes spatula and tongs • Stainless steel 	<table border="1"> <tr> <td>\$25.74</td> <td>\$47.99</td> <td>\$52.99</td> </tr> <tr> <td colspan="3">MASTER CARTON: 4</td> </tr> <tr> <td>H: 21.5</td> <td>W: 6.63</td> <td>D: 11.19</td> </tr> <tr> <td>Wt: 10.16</td> <td colspan="2">Cu.Ft.: 0.92</td> </tr> <tr> <td colspan="3">INDIVIDUAL CARTON:</td> </tr> <tr> <td>H: 21.1</td> <td>W: 6.1</td> <td>D: 2.6</td> </tr> <tr> <td>Wt: 2.54</td> <td colspan="2"></td> </tr> <tr> <td colspan="3">OUT OF CARTON:</td> </tr> <tr> <td>(Spatula) H: 18</td> <td>W: 3.5</td> <td>D: 4.5</td> </tr> <tr> <td>(Tongs) H: 17</td> <td>W: 1.2</td> <td>D: 1.6</td> </tr> </table>	\$25.74	\$47.99	\$52.99	MASTER CARTON: 4			H: 21.5	W: 6.63	D: 11.19	Wt: 10.16	Cu.Ft.: 0.92		INDIVIDUAL CARTON:			H: 21.1	W: 6.1	D: 2.6	Wt: 2.54			OUT OF CARTON:			(Spatula) H: 18	W: 3.5	D: 4.5	(Tongs) H: 17	W: 1.2	D: 1.6	 <p>0 77924 02149 7</p>
\$25.74	\$47.99	\$52.99																															
MASTER CARTON: 4																																	
H: 21.5	W: 6.63	D: 11.19																															
Wt: 10.16	Cu.Ft.: 0.92																																
INDIVIDUAL CARTON:																																	
H: 21.1	W: 6.1	D: 2.6																															
Wt: 2.54																																	
OUT OF CARTON:																																	
(Spatula) H: 18	W: 3.5	D: 4.5																															
(Tongs) H: 17	W: 1.2	D: 1.6																															
6608 BAMBOO SKEWERS	 <ul style="list-style-type: none"> • Disposable bamboo skewers • Set of 25 	<table border="1"> <tr> <td>\$2.95</td> <td>\$5.49</td> <td>\$6.49</td> </tr> <tr> <td colspan="3">MASTER CARTON: 12</td> </tr> <tr> <td>H: 14.19</td> <td>W: 4.07</td> <td>D: 9.19</td> </tr> <tr> <td>Wt: 2.83</td> <td colspan="2">Cu.Ft.: 0.3</td> </tr> <tr> <td colspan="3">INDIVIDUAL CARTON:</td> </tr> <tr> <td>H: 13.5</td> <td>W: 3.0</td> <td>D: 0.63</td> </tr> <tr> <td>Wt: 0.19</td> <td colspan="2"></td> </tr> <tr> <td colspan="3">OUT OF CARTON:</td> </tr> <tr> <td>H: 9.8</td> <td>W: 0.4</td> <td>D: 0.1</td> </tr> </table>	\$2.95	\$5.49	\$6.49	MASTER CARTON: 12			H: 14.19	W: 4.07	D: 9.19	Wt: 2.83	Cu.Ft.: 0.3		INDIVIDUAL CARTON:			H: 13.5	W: 3.0	D: 0.63	Wt: 0.19			OUT OF CARTON:			H: 9.8	W: 0.4	D: 0.1	 <p>0 77924 02194 7</p>			
\$2.95	\$5.49	\$6.49																															
MASTER CARTON: 12																																	
H: 14.19	W: 4.07	D: 9.19																															
Wt: 2.83	Cu.Ft.: 0.3																																
INDIVIDUAL CARTON:																																	
H: 13.5	W: 3.0	D: 0.63																															
Wt: 0.19																																	
OUT OF CARTON:																																	
H: 9.8	W: 0.4	D: 0.1																															

COOKING: GRIDDLE TOOLS NEW

6776 GRIDDLE ESSENTIAL SET	 <ul style="list-style-type: none"> • Griddle Spatula flips and moves heavier food with ease (1) • Griddle Scraper effectively removes grease and grime (1) • Flexible Griddle Spatula easily slides under delicate foods, like seafood and veggies (1) • Griddle Squeeze Bottles (2) 	<table border="1"> <tr> <td>\$33.96</td> <td>\$59.99</td> <td>\$69.99</td> </tr> <tr> <td colspan="3">MASTER CARTON: 2</td> </tr> <tr> <td>H: 17.72</td> <td>W: 12.6</td> <td>D: 8.47</td> </tr> <tr> <td>Wt: 7.17</td> <td colspan="2">Cu.Ft.: 1.09</td> </tr> <tr> <td colspan="3">INDIVIDUAL CARTON:</td> </tr> <tr> <td>H: 17.13</td> <td>W: 12.21</td> <td>D: 3.86</td> </tr> <tr> <td>Wt: 3.0</td> <td colspan="2"></td> </tr> <tr> <td colspan="3">OUT OF CARTON: HxWxD</td> </tr> <tr> <td colspan="3">Spatula: 16.4 x 4.0 x 4.3 Scraper: 12.4 x 5.5 x 1.1 Flexible Spatula: 15.5 x 3.8 x 3.2 Bottle: 7.7 x 2.8 x 2.8</td> </tr> </table>	\$33.96	\$59.99	\$69.99	MASTER CARTON: 2			H: 17.72	W: 12.6	D: 8.47	Wt: 7.17	Cu.Ft.: 1.09		INDIVIDUAL CARTON:			H: 17.13	W: 12.21	D: 3.86	Wt: 3.0			OUT OF CARTON: HxWxD			Spatula: 16.4 x 4.0 x 4.3 Scraper: 12.4 x 5.5 x 1.1 Flexible Spatula: 15.5 x 3.8 x 3.2 Bottle: 7.7 x 2.8 x 2.8			 <p>0 77924 19353 8</p>
\$33.96	\$59.99	\$69.99																												
MASTER CARTON: 2																														
H: 17.72	W: 12.6	D: 8.47																												
Wt: 7.17	Cu.Ft.: 1.09																													
INDIVIDUAL CARTON:																														
H: 17.13	W: 12.21	D: 3.86																												
Wt: 3.0																														
OUT OF CARTON: HxWxD																														
Spatula: 16.4 x 4.0 x 4.3 Scraper: 12.4 x 5.5 x 1.1 Flexible Spatula: 15.5 x 3.8 x 3.2 Bottle: 7.7 x 2.8 x 2.8																														
6777 GRIDDLE STARTER SET	 <ul style="list-style-type: none"> • Griddle Spatula flips and moves heavier food with ease (1) • Griddle Scraper effectively removes grease and grime (1) • Griddle Squeeze Bottle (1) • Dishwasher safe and BPA Free 	<table border="1"> <tr> <td>\$23.20</td> <td>\$40.99</td> <td>\$45.99</td> </tr> <tr> <td colspan="3">MASTER CARTON: 2</td> </tr> <tr> <td>H: 17.72</td> <td>W: 9.45</td> <td>D: 8.47</td> </tr> <tr> <td>Wt: 5.52</td> <td colspan="2">Cu.Ft.: 0.82</td> </tr> <tr> <td colspan="3">INDIVIDUAL CARTON:</td> </tr> <tr> <td>H: 17.13</td> <td>W: 8.86</td> <td>D: 3.86</td> </tr> <tr> <td>Wt: 2.5</td> <td colspan="2"></td> </tr> <tr> <td colspan="3">OUT OF CARTON: HxWxD</td> </tr> <tr> <td colspan="3">Spatula: 16.4 x 4.0 x 4.3 Scraper: 12.4 x 5.5 x 1.1 Bottle: 7.7 x 2.8 x 2.8</td> </tr> </table>	\$23.20	\$40.99	\$45.99	MASTER CARTON: 2			H: 17.72	W: 9.45	D: 8.47	Wt: 5.52	Cu.Ft.: 0.82		INDIVIDUAL CARTON:			H: 17.13	W: 8.86	D: 3.86	Wt: 2.5			OUT OF CARTON: HxWxD			Spatula: 16.4 x 4.0 x 4.3 Scraper: 12.4 x 5.5 x 1.1 Bottle: 7.7 x 2.8 x 2.8			 <p>0 77924 19354 5</p>
\$23.20	\$40.99	\$45.99																												
MASTER CARTON: 2																														
H: 17.72	W: 9.45	D: 8.47																												
Wt: 5.52	Cu.Ft.: 0.82																													
INDIVIDUAL CARTON:																														
H: 17.13	W: 8.86	D: 3.86																												
Wt: 2.5																														
OUT OF CARTON: HxWxD																														
Spatula: 16.4 x 4.0 x 4.3 Scraper: 12.4 x 5.5 x 1.1 Bottle: 7.7 x 2.8 x 2.8																														



ACCESSORIES



FOB



MAP



MSRP



COOKING: GRIDDLE TOOLS NEW



6778	GRIDDLE BREAKFAST SET	\$16.98	\$29.99	\$44.99	 0 77924 19355 2
 <ul style="list-style-type: none"> • Egg Rings (2) are stackable and easy to store • Batter Dispenser (1) holds up to 27 oz. of batter, marinades and more • Dishwasher safe and BPA Free 		MASTER CARTON: 2			
		H: 12.01 W: 9.06 D: 4.73 Wt: 1.61 Cu.Ft.: 0.3			
		INDIVIDUAL CARTON:			
		H: 11.25 W: 4.38 D: 4.38 Wt: 0.6			
		OUT OF CARTON: HxWxD			
		Egg Rings: 1.2 x W x 4.1 Batter Dispenser: 10.5 x W x 2.8			

6779	GRIDDLE SPATULA	\$12.45	\$21.99	\$24.99	 0 77924 19356 9
 <ul style="list-style-type: none"> • Beveled edge easily slides under food from any direction. • No-slip handle is elevated to avoid resting on messy surfaces. • Dishwasher safe. 		MASTER CARTON: 6			
		H: 17.33 W: 4.73 D: 13 Wt: 6.95 Cu.Ft.: 0.62			
		INDIVIDUAL CARTON:			
		H: 16.54 W: 3.94 D: 1.97 Wt: 0.07			
		OUT OF CARTON:			
		H: 16.4 W: 4.0 D: 4.3			

6780	GRIDDLE FLEXIBLE SPATULA	\$10.75	\$18.99	\$21.99	 0 77924 19357 6
 <ul style="list-style-type: none"> • Beveled edge easily slides under delicate foods. • Slotted for no-stick release. • Angled to easily fold, flip and turn. • Dishwasher safe. 		MASTER CARTON: 6			
		H: 16.15 W: 4.33 D: 11.42 Wt: 3.31 Cu.Ft.: 0.46			
		INDIVIDUAL CARTON:			
		H: 15.36 W: 3.74 D: 1.78 Wt: 0.5			
		OUT OF CARTON:			
		H: 15.5 W: 3.8 D: 3.2			

6781	GRIDDLE SCRAPER	\$10.75	\$18.99	\$21.99	 0 77924 19358 3
 <ul style="list-style-type: none"> • Scrapes away grease and grime. • No-slip, easy grip handle. • Dishwasher safe. 		MASTER CARTON: 6			
		H: 13.39 W: 6.3 D: 10.24 Wt: 4.85 Cu.Ft.: 0.5			
		INDIVIDUAL CARTON:			
		H: 12.5 W: 5.71 D: 1.58 Wt: 0.9			
		OUT OF CARTON:			
		H: 12.4 W: 5.5 D: 1.1			

6782	GRIDDLE SQUEEZE BOTTLES	\$7.35	\$12.99	\$15.99	 0 77924 19359 0
 <ul style="list-style-type: none"> • 2 easy-to-dispense, 16 oz. bottles with twist-close cap to prevent spills. • Dishwasher safe and BPA free. 		MASTER CARTON: 4			
		H: 8.4 W: 6.69 D: 13.11 Wt: 6.66 Cu.Ft.: 0.42			
		INDIVIDUAL CARTON:			
		H: 8.27 W: 6.73 D: 12.99 Wt: 1.66			
		OUT OF CARTON:			
		H: 7.7 W: 2.8 D: 2.8			



6783	GRIDDLE BASTING DOME	\$24.40	\$39.99	\$44.99	 0 77924 19361 3
 <ul style="list-style-type: none"> • Melts cheese and steams veggies, rice and more • Covers up to 4 standard 4" burgers at once • T-shaped handle for ease of use • Dishwasher safe 		MASTER CARTON: 4			
		H: 11.62 W: 12.41 D: 18.9 Wt: 7.94 Cu.Ft.: 1.58			
		INDIVIDUAL CARTON:			
		H: 10.44 W: 10.44 D: 3.55 Wt: 1.13			
		OUT OF CARTON:			
		H: 10.2 W: 10.2 D: 4.9			



FOB



MAP

MSRP

COOKING: GRIDDLE TOOLS NEW



6784	GRIDDLE KEEP WARM RACK	\$19.89	\$31.99	\$36.99			
	<ul style="list-style-type: none"> • Highly durable construction • Raised back edge to lift food with ease • Collapsible legs for easy storage 	MASTER CARTON: 4					
		H: 8.67	W: 17.33	D: 9.45		Wt: 9.92	Cu.Ft.: 0.82
		INDIVIDUAL CARTON:					
H: 7.48	W: 15.75	D: 1.19	Wt: 1.5				
OUT OF CARTON:							
H: 2.6	W: 16.5	D: 7.8					

6785	GRIDDLE PRESS	\$20.13	\$32.99	\$37.99			
	<ul style="list-style-type: none"> • Presses burgers and paninis, and up to 4 strips of bacon without curling. • Textured design keeps food from sticking. 	MASTER CARTON: 4					
		H: 4.33	W: 10.63	D: 18.7		Wt: 19.4	Cu.Ft.: 0.5
		INDIVIDUAL CARTON:					
H: 2.92	W: 8.86	D: 6.0	Wt: 3.75				
OUT OF CARTON:							
H: 2.9	W: 9.0	D: 6.0					

6786	CROSSBACK APRON	\$26.30	\$39.99	\$54.99			
	<ul style="list-style-type: none"> • 7 easy-access pockets, durable clothing protection and crossback straps for a comfortable fit. 	MASTER CARTON: 6					
		H: 7.48	W: 8.67	D: 12.21		Wt: 6.62	Cu.Ft.: 0.46
		INDIVIDUAL CARTON:					
H: 6.79	W: 4.06	D: 3.86	Wt: 1.02				
OUT OF CARTON:							
H: 35.5	W: 26.5	D: 0.1					

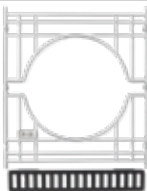
WEBER CRAFTED: FRAME KITS

7677	WEBER CRAFTED FRAME KIT	\$33.59			\$49.99		
	<ul style="list-style-type: none"> • Frame Kit is required to use WEBER CRAFTED grillware • Sits under the right-side cooking grate when not in use • Fits GENESIS (2022), GENESIS II 300 and 400 series gas grills 	MASTER CARTON: 4					
		H: 10.0	W: 19	D: 21.1	Wt: 31.9		Cu.Ft.: 2.3
		INDIVIDUAL CARTON:					
H: 2.1	W: 18.3	D: 20.2	Wt: 7.1				
OUT OF CARTON:							
H: 1.0	W: 16.8	D: 18.9					

7678	WEBER CRAFTED FRAME KIT	\$33.59			\$49.99		
	<ul style="list-style-type: none"> • Frame Kit is required to use WEBER CRAFTED grillware • Sits under the right-side cooking grate when not in use • Fits SPIRIT 200 and 300 series, SPIRIT II 200 and 300 series, and SMOKEFIRE EX4 wood pellet grills 	MASTER CARTON: 4					
		H: 10.0	W: 19	D: 19.7	Wt: 25.4		Cu.Ft.: 2.2
		INDIVIDUAL CARTON:					
H: 2.1	W: 18.3	D: 18.9	Wt: 5.6				
OUT OF CARTON:							
H: 1.0	W: 16.8	D: 17.5					











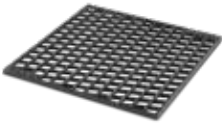

ACCESSORIES

FOB

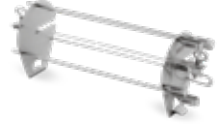





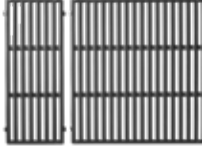

MAP

MSRP

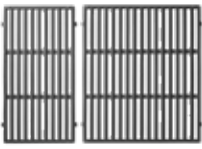
WEBER CRAFTED: GRILLWARE (WEBER CRAFTED frame and grates required.)

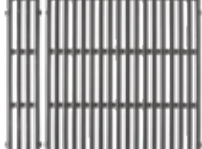
<p>7670</p> 	<p>WEBER CRAFTED DUAL SIDED SEAR GRATE</p> <ul style="list-style-type: none"> Creates restaurant-quality sear marks Designed to grill meat on one side, delicate food on the reverse Porcelain enamel helps make flipping and lifting food easy Extra large surface for searing multiple steaks at once 	<p>\$63.83 \$109.99 \$119.99</p> <p>MASTER CARTON: 1 H: 1.9 W: 18.7 D: 20.1 Wt: 11.4 Cu.Ft.: 0.4</p> <p>INDIVIDUAL CARTON: H: 1.5 W: 18.3 D: 19.2 Wt: 10.3</p> <p>OUT OF CARTON: H: 0.3 W: 16.0 D: 16.3</p>	 <p>0 77924 17439 1</p>
<p>7671</p> 	<p>WEBER CRAFTED GLAZED BAKING STONE</p> <ul style="list-style-type: none"> Designed to create perfectly crispy pizza crust Glazed finish helps keep food from sticking and cleanup easy Stone designed to efficiently absorb, retain, and distribute heat 	<p>\$63.83 \$109.99 \$119.99</p> <p>MASTER CARTON: 1 H: 3.7 W: 21.5 D: 20.9 Wt: 11.2 Cu.Ft.: 1.0</p> <p>INDIVIDUAL CARTON: H: 3.0 W: 20.1 D: 19.9 Wt: 10.2</p> <p>OUT OF CARTON: H: 0.5 W: 16.0 D: 16.3</p>	 <p>0 77924 17437 7</p>
<p>7672</p> 	<p>WEBER CRAFTED FLAT TOP</p> <ul style="list-style-type: none"> Make pancakes & eggs to fajitas on the large, flat surface Heats quickly and evenly with warp-resistant carbon steel Rimmed edge helps keeps oil, and seasonings in place 	<p>\$63.83 \$109.99 \$119.99</p> <p>MASTER CARTON: 1 H: 2.8 W: 19.8 D: 20.3 Wt: 16.1 Cu.Ft.: 0.7</p> <p>INDIVIDUAL CARTON: H: 2.3 W: 19.3 D: 19.8 Wt: 15.3</p> <p>OUT OF CARTON: H: 1.0 W: 15.8 D: 16.3</p>	 <p>0 77924 17435 3</p>
<p>7675</p> 	<p>WEBER CRAFTED ROTISSERIE SKEWERS</p> <ul style="list-style-type: none"> 16-in. skewers slowly rotate for even cooking Simply slides onto the rotisserie spit Dishwasher safe, stainless-steel construction Grill rotisserie unit required for use 	<p>\$42.16 \$72.99 \$82.99</p> <p>MASTER CARTON: 2 H: 6.5 W: 6.1 D: 18.3 Wt: 5.2 Cu.Ft.: 0.4</p> <p>INDIVIDUAL CARTON: H: 2.8 W: 6.0 D: 17.2 Wt: 2.3</p> <p>OUT OF CARTON: H: 5.3 W: 17.7 D: 6.6</p>	 <p>0 77924 17429 2</p>
<p>7673</p> 	<p>WEBER CRAFTED ROASTING BASKET</p> <ul style="list-style-type: none"> Roast small, delicate food without it falling through the grate WEBER CRAFTED frame and grates required Helps with heat circulation for perfectly roasted veggies Dishwasher safe, stainless-steel construction 	<p>\$63.83 \$109.99 \$119.99</p> <p>MASTER CARTON: 1 H: 2.7 W: 17.6 D: 17.6 Wt: 4.5 Cu.Ft.: 0.5</p> <p>INDIVIDUAL CARTON: H: 2.0 W: 16.3 D: 17.2 Wt: 3.1</p> <p>OUT OF CARTON: H: 2.0 W: 17.2 D: 16.3</p>	 <p>0 77924 17433 9</p>
<p>7676</p> 	<p>WEBER CRAFTED CRISPING BASKET</p> <ul style="list-style-type: none"> Circulates heat evenly for quick, crispy results. Quickly connects to your rotisserie spit. Crisp a variety of food all at once with the removable divider (included). 	<p>\$51.98 \$89.49 \$99.49</p> <p>MASTER CARTON: 1 H: 10.25 W: 18.3 D: 21.5 Wt: 10.6 Cu.Ft.: 2.3</p> <p>INDIVIDUAL CARTON: H: 9.0 W: 9.85 D: 20.75 Wt: 5.2</p> <p>OUT OF CARTON: H: 7.55 W: 19.11 D: 7.91</p>	 <p>0 77924 17427 8</p>

WEBER CRAFTED: COOKING GRATES

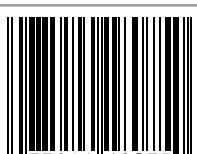
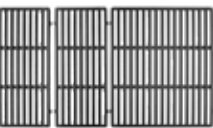
7856	WEBER CRAFTED PECI COOKING GRATES	\$69.79 \$117.59 \$127.59	 0 77924 18078 1
 <ul data-bbox="418 346 787 493" style="list-style-type: none"> • Fits SPIRIT 300 series 2016+ and SMOKEFIRE EX4 grills • Required to use most WEBER CRAFTED grillware • Superior heat retention and distribution • Set of 2 		MASTER CARTON: 1 H: 3.1 W: 19.9 D: 22.9 Wt: 15.4 Cu.Ft.: 0.8 INDIVIDUAL CARTON: H: 2.3 W: 19.0 D: 20.4 Wt: 12.9 OUT OF CARTON: H: 0.4 W: 23.6 D: 17.5	
7853	WEBER CRAFTED PECI COOKING GRATE	\$87.33 \$147.83 \$155.99	 0 77924 18074 3
 <ul data-bbox="418 634 787 760" style="list-style-type: none"> • Fits GENESIS 300 series grills 2016+ • Required to use most WEBER CRAFTED grillware • Superior heat retention and distribution • Set of 2 		MASTER CARTON: 1 H: 3.1 W: 19.9 D: 23.7 Wt: 17.5 Cu.Ft.: 0.8 INDIVIDUAL CARTON: H: 2.3 W: 19.0 D: 21.9 Wt: 15.0 OUT OF CARTON: H: 0.4 W: 26.8 D: 18.9	
7849	WEBER CRAFTED PECI COOKING GRATES	\$60.15 \$105.27 \$114.99	 0 77924 18070 5
 <ul data-bbox="418 921 787 1047" style="list-style-type: none"> • Fits SPIRIT 200 series 2016+ • Required to use most WEBER CRAFTED grillware • Superior heat retention and distribution • Set of 2 		MASTER CARTON: 1 H: 3.1 W: 19.9 D: 22.9 Wt: 13.5 Cu.Ft.: 0.8 INDIVIDUAL CARTON: H: 2.3 W: 19 D: 20.4 Wt: 10.9 OUT OF CARTON: H: 0.4 W: 20.3 D: 17.5	
7860	WEBER CRAFTED STAINLESS STEEL COOKING GRATES	\$76.65 \$135.51 \$145.49	 0 77924 18082 8
 <ul data-bbox="418 1209 787 1377" style="list-style-type: none"> • Fits SPIRIT 300 series 2016+ and SMOKEFIRE EX4 • Required to use most WEBER CRAFTED grillware • Highly durable 7mm stainless steel rods clean easily • Set of 2 		MASTER CARTON: 1 H: 3.6 W: 22.1 D: 23.5 Wt: 12.6 Cu.Ft.: 1.1 INDIVIDUAL CARTON: H: 2.3 W: 19.0 D: 21.9 Wt: 10.1 OUT OF CARTON: H: 0.6 W: 23.5 D: 17.3	
7852	WEBER CRAFTED STAINLESS STEEL COOKING GRATE	\$115.63 \$201.59 \$219.99	 0 77924 18073 6
 <ul data-bbox="418 1497 787 1644" style="list-style-type: none"> • Fits GENESIS 300 series grills 2016+ • Required to use most WEBER CRAFTED grillware • Highly durable 7mm stainless steel rods clean easily • Set of 2 		MASTER CARTON: 1 H: 3.6 W: 22.1 D: 23.5 Wt: 12.6 Cu.Ft.: 1.1 INDIVIDUAL CARTON: H: 2.3 W: 19.0 D: 21.9 Wt: 10.1 OUT OF CARTON: H: 0.6 W: 26.6 D: 18.9	
7854	WEBER CRAFTED PECI COOKING GRATES	\$105.72 \$179.19 \$199.99	 0 77924 18075 0
 <ul data-bbox="418 1785 787 1911" style="list-style-type: none"> • Fits GENESIS 400 series grills 2016+ • Required to use most WEBER CRAFTED grillware • Superior heat retention and distribution • Set of 3 		MASTER CARTON: 1 H: 4.1 W: 20.2 D: 25.9 Wt: 16.5 Cu.Ft.: 1.2 INDIVIDUAL CARTON: H: 3.3 W: 19.3 D: 23.5 Wt: 14.0 OUT OF CARTON: H: 0.4 W: 33.7 D: 18.9	

ACCESSORIES



FOB



MAP

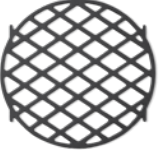

MSRP



GBS: INSERTS



8834	SEAR GRATE		\$32.03	\$59.49	\$69.49	 0 77924 00435 3	
 <ul style="list-style-type: none"> • Porcelain-enameled, cast-iron sear grate prevents food from sticking and creates professional cross-hatch sear marks • Fits into the GOURMET BBQ SYSTEM cooking grate so that it stays in place while grilling 	MASTER CARTON: 1	H: 2.63	W: 15.88	D: 15.3	Wt: 6.61		Cu.Ft.: 0.37
	INDIVIDUAL CARTON:						
	H: 15.38	W: 15.88	D: 2.63	Wt: 6.61			
	OUT OF CARTON:						
H: 11.9	W: 11.9	D: 0.5					

7421	GRIDDLE		\$32.03	\$59.49	\$69.49	 0 77924 00412 4	
 <ul style="list-style-type: none"> • Porcelain-enameled, cast-iron griddle provides exceptional heat retention and distribution ensuring evenly cooked food • Fits into the GOURMET BBQ SYSTEM cooking grate so that it stays in place while grilling 	MASTER CARTON: 1	H: 2.63	W: 15.88	D: 15.38	Wt: 8.5		Cu.Ft.: 0.37
	INDIVIDUAL CARTON:						
	H: 15.38	W: 15.88	D: 2.63	Wt: 8.5			
	OUT OF CARTON:						
H: 15.2	W: 12.0	D: 2.0					

8836	PIZZA STONE		\$32.03	\$59.49	\$69.49	 0 77924 01328 7	
 <ul style="list-style-type: none"> • Cordierite stone absorbs moisture for light and crispy thin crust pizza • Carry rack makes transporting the pizza quick and easy • Fits into the GOURMET BBQ SYSTEM cooking grate so that it stays in place while grilling 	MASTER CARTON: 1	H: 4.44	W: 15.88	D: 16.38	Wt: 6.5		Cu.Ft.: 0.66
	INDIVIDUAL CARTON:						
	H: 16.38	W: 15.88	D: 4.44	Wt: 6.5			
	OUT OF CARTON:						
H: 16.7	W: 13.2	D: 2.0					

8838	POULTRY ROASTER		\$42.58	\$72.99	\$82.99	 0 77924 01903 6	
 <ul style="list-style-type: none"> • Stainless steel • Roast a whole chicken using the liquid infusion cup • Remove cup and use basket alone for roasting vegetables or other small food items • Fits into the GOURMET BBQ SYSTEM cooking grate so that it stays in place while grilling 	MASTER CARTON: 1	H: 3.69	W: 16.69	D: 17.0	Wt: 3.94		Cu.Ft.: 0.6
	INDIVIDUAL CARTON:						
	H: 17.0	W: 16.69	D: 3.69	Wt: 3.94			
	OUT OF CARTON:						
H: 15.9	W: 13	D: 3.6					

8859	DUTCH OVEN DUO		\$99.31	\$167.99	\$187.99	 0 77924 16218 3	
 <ul style="list-style-type: none"> • Multi-purpose cooker with a flat top lid that can be used as a griddle • Pieces can be used together or separately • Designed for compact storage • Easy to clean, porcelain-enameled, cast iron • Fits into the GOURMET BBQ SYSTEM cooking grate so that it stays in place while grilling 	MASTER CARTON: 1	H: 6.7	W: 16.93	D: 17.72	Wt: 24.24		Cu.Ft.: 1.16
	INDIVIDUAL CARTON:						
	H: 16.14	W: 16.54	D: 5.71	Wt: 22.47			
	OUT OF CARTON:						
H: 4.83	W: 16.68	D: 13.19					

8860	GRILL & GRIDDLE STATION		\$58.39	\$106.49	\$116.49	 0 77924 16219 0	
 <ul style="list-style-type: none"> • Grills and sears various foods at the same time, maximizing space • Easy to clean, porcelain-enameled, cast iron • Stacks for compact storage • Fits into the GOURMET BBQ SYSTEM cooking grate so that it stays in place while grilling 	MASTER CARTON: 1	H: 3.67	W: 11.03	D: 19.18	Wt: 14.6		Cu.Ft.: 0.44
	INDIVIDUAL CARTON:						
	H: 10.25	W: 17.91	D: 3.15	Wt: 13.14			
	OUT OF CARTON:						
H: 14.29	W: 14.1	D: 1.13					

FOB

MAP

MSRP

GBS: GRATES

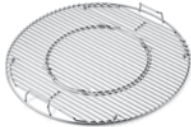
8835	COOKING GRATES		\$34.22	\$59.49	\$69.49	 0 77924 00490 2	
 <ul style="list-style-type: none"> • Hinged cooking grate for adding charcoal without removing the grate • For use with GOURMET BBQ SYSTEM inserts • Includes a 12 inch plated grate insert for traditional grilling • Fits 22 inch WEBER charcoal grills 	MASTER CARTON: 5	H: 3.38	W: 22.88	D: 22.88	Wt: 42.75		Cu.Ft.: 1.02
	INDIVIDUAL CARTON:	H: 21.5	W: 21.5	D: 1.75	Wt: 8.22		
	OUT OF CARTON:	H: 21.5	W: 21.5	D: 1.5			

COOKING: BASKETS AND PANS

8829	GRILLING STONE		\$51.51	\$79.49	\$89.49	 0 77924 06340 4	
<ul style="list-style-type: none"> • Stone distributes heat quickly and evenly • Specially formulated glaze promotes crispy, restaurant-quality crusts • Durable finish resists fading, cracking and chipping • Versatile stone is ideal for baking pizzas, cookies, breads and pastries • Integrated handles make the stone easy to lift and move • Safe for use with gas, charcoal and electric grills 	MASTER CARTON: 1	H: 5.04	W: 19.06	D: 20.63	Wt: 10.0		Cu.Ft.: 1.14
	INDIVIDUAL CARTON:	H: 19.06	W: 20.63	D: 5.04	Wt: 10.0		
	OUT OF CARTON:	H: 18.5	W: 16.5	D: 1.0			

6481	DELUXE GRILLING BASKET		\$13.65	\$24.49	\$29.49	 0 77924 01112 2	
<ul style="list-style-type: none"> • Ideal for vegetables and smaller pieces of meat • Stainless steel • Fits all WEBER charcoal, gas, and electric grills 	MASTER CARTON: 6	H: 3.82	W: 8.75	D: 10.57	Wt: 6.81		Cu.Ft.: 0.2
	INDIVIDUAL CARTON:	H: 9.4	W: 7.5	D: 2.5	Wt: 1.02		
	OUT OF CARTON:	H: 9.4	W: 7.5	D: 2.5			

6434	DELUXE GRILLING BASKET		\$18.77	\$30.99	\$35.99	 0 77924 07488 2	
<ul style="list-style-type: none"> • Ideal for vegetables and smaller pieces of meat • Stainless steel • Fits all WEBER Q 300/3000 and larger gas grills, and 18 inch and larger charcoal grills 	MASTER CARTON: 4	H: 3.12	W: 13.0	D: 15.25	Wt: 9.15		Cu.Ft.: 0.35
	INDIVIDUAL CARTON:	H: 13.8	W: 11.8	D: 2.5	Wt: 2.02		
	OUT OF CARTON:	H: 13.8	W: 11.8	D: 2.5			

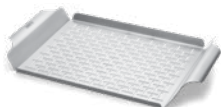
6435	DELUXE GRILLING PAN		\$18.77	\$30.99	\$35.99	 0 77924 07489 9	
<ul style="list-style-type: none"> • Ideal for fish fillets or other delicate items that may fall between the grates • Fits WEBER Q 300/3000 and larger gas grills, 22 inch and larger charcoal grills 	MASTER CARTON: 6	H: 2.88	W: 13.0	D: 18.63	Wt: 14.2		Cu.Ft.: 0.4
	INDIVIDUAL CARTON:	H: 17.57	W: 11.88	D: 1.38	Wt: 2.14		
	OUT OF CARTON:	H: 17.4	W: 11.8	D: 1.4			



ACCESSORIES



FOB



MAP



MSRP



COOKING: RACKS AND ROASTERS



6482	POULTRY ROASTER	\$14.76	\$24.49	\$29.49			
 <ul style="list-style-type: none"> Makes transporting your roasted chicken to and from the grill quick and easy Center ring holds 12 oz. beverage to infuse poultry with flavor 	MASTER CARTON: 6	H: 12.32	W: 7.57	D: 10.07		Wt: 6.41	Cu.Ft.: 0.54
	INDIVIDUAL CARTON:	H: 5.13	W: 9.32	D: 6.63		Wt: 0.88	
	OUT OF CARTON:	H: 6.5	W: 9.3	D: 5.0			
						0 77924 01196 2	

6731	DELUXE POULTRY ROASTER	\$27.41	\$47.99	\$52.99			
 <ul style="list-style-type: none"> Integrated cup holds juices, wine, beer and spices, infusing extra flavor into your poultry Easy to clean, non-stick coating 	MASTER CARTON: 2	H: 9.13	W: 9.25	D: 10.38		Wt: 4.89	Cu.Ft.: 0.5
	INDIVIDUAL CARTON:	H: 8.38	W: 9.88	D: 4.38		Wt: 2.2	
	OUT OF CARTON:	H: 15.5	W: 12.3	D: 3.5			
						0 77924 01814 5	

6469	PREMIUM BARBECUE RACK	\$17.71	\$29.49	\$34.49			
 <ul style="list-style-type: none"> 2-in-1 design for roasting large cuts of meat or grilling up to five racks of ribs Fits WEBER Q 300/3000 and larger gas grills, and 22 inch and larger charcoal grills 	MASTER CARTON: 4	H: 10.38	W: 11.32	D: 17.63		Wt: 8.31	Cu.Ft.: 1.2
	INDIVIDUAL CARTON:	H: 16.8	W: 10.6	D: 4.4		Wt: 2.1	
	OUT OF CARTON:	H: 17.1	W: 10.5	D: 4.4			
						0 77924 01083 5	

6605	RIB RACK	\$12.57	\$21.49	\$24.49			
 <ul style="list-style-type: none"> Holds up to five racks of ribs, increasing grill capacity Fits WEBER Q 200/2000 and larger gas grills, and 18 inch and larger charcoal grills 	MASTER CARTON: 6	H: 11.2	W: 8.68	D: 13.81		Wt: 7.75	Cu.Ft.: 0.77
	INDIVIDUAL CARTON:	H: 13.22	W: 8.16	D: 3.5		Wt: 1.13	
	OUT OF CARTON:	H: 13.2	W: 8.0	D: 3.5			
						0 77924 02188 6	

7647	EXPANSION GRILLING RACK	\$33.73	\$59.49	\$69.49			
 <ul style="list-style-type: none"> Adds grilling space for cooking larger meals Stainless steel Fits SUMMIT charcoal grills, 26 inch WEBER charcoal grills, 22 inch SMOKEY MOUNTAIN COOKER smoker, GENESIS and SUMMIT gas grills (with warming rack removed) 	MASTER CARTON: 2	H: 4.94	W: 13.07	D: 20.25		Wt: 7.9	Cu.Ft.: 0.75
	INDIVIDUAL CARTON:	H: 19.5	W: 12.0	D: 1.5		Wt: 3.2	
	OUT OF CARTON:	H: 22.0	W: 12.1	D: 5.1			
						0 77924 04181 5	



6470	GRILLING BASKET	\$21.67	\$40.49	\$45.49			
 <ul style="list-style-type: none"> Flexible wire accommodates a variety of food sizes and shapes Stainless steel Fits WEBER Q 100/1000 and larger gas grills, SMOKEY JOE and larger charcoal grills 	MASTER CARTON: 4	H: 9.44	W: 11.32	D: 12.07		Wt: 5.3	Cu.Ft.: 0.74
	INDIVIDUAL CARTON:	H: 8.19	W: 11.03	D: 2.07		Wt: 0.99	
	OUT OF CARTON:	H: 11.0	W: 8.1	D: 2.2			
						0 77924 01113 9	

FOB



MAP



MSRP



COOKING: RACKS AND ROASTERS



6471	GRILLING BASKET		\$26.75	\$47.99	\$52.99	 0 77924 01084 2	
 <ul style="list-style-type: none"> Flexible wire accommodates a variety of food sizes and shapes Stainless steel Fits WEBER Q 300/3000 and larger gas grills and 18 inch and larger charcoal grills 	MASTER CARTON: 4	H: 12.5	W: 11.32	D: 19.07	Wt: 8.55		Cu.Ft.: 1.56
	INDIVIDUAL CARTON:	H: 11.18	W: 18.11	D: 2.1	Wt: 1.7		
	OUT OF CARTON:						
	H: 18.1	W: 1.1	D: 2.2				

COOKING: ROTISSERIES

7659	ROTISSERIE		\$78.39	\$134.49	\$144.49	 0 77924 05882 0	
 <ul style="list-style-type: none"> Forks designed to hold both large and small cuts of meat Includes stainless steel shaft, forks, handle, and hardware Fits SPIRIT and SPIRIT II 200/300 series gas grills 	MASTER CARTON: 1	H: 4.5	W: 20.63	D: 5.94	Wt: 5.73		Cu.Ft.: 0.31
	INDIVIDUAL CARTON:	H: 5.94	W: 20.63	D: 4.5	Wt: 5.73		
	OUT OF CARTON:	H: 33.4	W: 5.5	D: 5.2			

7652	ROTISSERIE		\$83.37	\$145.49	\$155.49	 0 77924 05204 0	
 <ul style="list-style-type: none"> Forks designed to hold both large and small cuts of meat Includes stainless steel shaft, forks, handle, and hardware Fits GENESIS II 200/300 series gas grills GENESIS 300 series gas grills (2016+) 	MASTER CARTON: 1	H: 3.44	W: 29.69	D: 5.5	Wt: 6.28		Cu.Ft.: 0.32
	INDIVIDUAL CARTON:	H: 5.5	W: 29.69	D: 3.44	Wt: 6.28		
	OUT OF CARTON:	H: 42.1	W: 4.4	D: 5.6			

7653	ROTISSERIE		\$96.45	\$156.99	\$176.99	 0 77924 05206 4	
 <ul style="list-style-type: none"> Forks designed to hold both large and small cuts of meat Includes stainless steel shaft, forks, handle, and hardware Fits GENESIS II 400/600 series gas grills GENESIS 400 series gas grills (2016+) 	MASTER CARTON: 1	H: 3.44	W: 43.75	D: 5.5	Wt: 8.75		Cu.Ft.: 0.47
	INDIVIDUAL CARTON:	H: 5.5	W: 43.75	D: 3.44	Wt: 8.75		
	OUT OF CARTON:	H: 55.7	W: 4.4	D: 5.6			

2290	KETTLE ROTISSERIE		\$162.49	\$234.99	\$284.99	 0 77924 02290 6	
 <ul style="list-style-type: none"> Porcelain-enameled ring elevates the rotisserie to optimize grilling space Includes a motor, 2 spit forks, and a shaft This item provided in non-retail, plain brown packaging Fits 22 inch WEBER charcoal grills 	MASTER CARTON: 1	H: 7.44	W: 24.19	D: 30.75	Wt: 16.44		Cu.Ft.: 3.2
	INDIVIDUAL CARTON:	H: 30.75	W: 24.19	D: 7.44	Wt: 16.44		
	OUT OF CARTON:	H: 36.0	W: 23.4	D: 6.3			













ACCESSORIES

FOB













MAP

MSRP

COOKING: GRIDDLES AND GRATES

6787	SPIRIT FULL-SIZE GRIDDLE	\$129.35	\$199.00	\$219.00	
 <p>NEW</p>	<ul style="list-style-type: none"> Converts SPIRIT 300 series gas grills* to a full-size griddle for best-of-both-worlds versatility *2016 and newer Compatible grease management prevents spills and effectively captures grease Durable carbon steel delivers even heat to easily sauté, brown or sear 	MASTER CARTON: 1 H: 20.3 W: 26.0 D: 3.15 Wt: 22.0 Cu.Ft.: 0.96 INDIVIDUAL CARTON: H: 20.3 W: 26.0 D: 3.15 Wt: 22.0 OUT OF CARTON: H: 1.19 W: 22.67 D: 17.29			0 77924 19374 3
6788	GENESIS FULL-SIZE GRIDDLE	\$161.85	\$249.00	\$299.00	
 <p>NEW</p>	<ul style="list-style-type: none"> Converts GENESIS 300 series gas grills* to a full-size griddle for best-of-both-worlds versatility *2016 and newer Compatible grease management prevents spills and effectively captures grease Durable carbon steel delivers even heat to easily sauté, brown or sear 	MASTER CARTON: 1 H: 21.65 W: 29.0 D: 3.15 Wt: 26.3 Cu.Ft.: 1.14 INDIVIDUAL CARTON: H: 21.65 W: 29.0 D: 3.15 Wt: 26.3 OUT OF CARTON: H: 1.19 W: 25.67 D: 18.67			0 77924 19375 0
6789	GENESIS FULL-SIZE GRIDDLE	\$194.35	\$299.00	\$349.00	
 <p>NEW</p>	<ul style="list-style-type: none"> Converts GENESIS 400 series gas grills* to a full-size griddle for best-of-both-worlds versatility *2016 and newer Compatible grease management prevents spills and effectively captures grease Durable carbon steel delivers even heat to easily sauté, brown or sear 	MASTER CARTON: 1 H: 21.65 W: 36.0 D: 3.15 Wt: 33.2 Cu.Ft.: 1.42 INDIVIDUAL CARTON: H: 21.65 W: 36.0 D: 3.15 Wt: 33.2 OUT OF CARTON: H: 1.19 W: 32.67 D: 18.67			0 77924 19376 7
7034	TRAVELER GRIDDLE	\$64.99	\$99.99	\$109.99	
 <p>NEW</p>	<ul style="list-style-type: none"> Porcelain-enameled cast-iron material retains heat and requires no seasoning Surface prevents sticking Cleans easily with soap and water Fits WEBER TRAVELER grills Cleans easily with soap and water 	MASTER CARTON: 1 H: 17.95 W: 16.45 D: 1.15 Wt: 9.25 Cu.Ft.: 0.2 INDIVIDUAL CARTON: H: 17.95 W: 16.45 D: 1.15 Wt: 9.25 OUT OF CARTON: H: 0.5 W: 12.6 D: 13.5			0 77924 19405 4
6611	LUMIN COMPACT GRIDDLE	\$52.33	\$89.99	\$99.99	
 <p>NEW</p>	<ul style="list-style-type: none"> Make a variety of foods—from eggs and pancakes to fish, vegetables and fruit Save time—porcelain enamel coating doesn't require seasoning and prevents food from sticking Designed to replace a grate in a LUMIN COMPACT electric grill 	MASTER CARTON: 1 H: 12.5 W: 15.6 D: 1.25 Wt: 9.5 Cu.Ft.: 0.14 INDIVIDUAL CARTON: H: 12.5 W: 15.6 D: 1.25 Wt: 9.5 OUT OF CARTON: H: 0.5 W: 15.5 D: 11.5			0 77924 19420 7
6612	LUMIN GRIDDLE	\$59.40	\$99.99	\$109.99	
 <p>NEW</p>	<ul style="list-style-type: none"> Make a variety of foods—from eggs and pancakes to fish, vegetables and fruit Save time—porcelain enamel coating doesn't require seasoning and prevents food from sticking Designed to replace a grate in a LUMIN electric grill 	MASTER CARTON: 1 H: 13.7 W: 17.5 D: 1.25 Wt: 12.1 Cu.Ft.: 0.17 INDIVIDUAL CARTON: H: 13.7 W: 17.95 D: 1.25 Wt: 12.1 OUT OF CARTON: H: 0.5 W: 18.25 D: 13.0			0 77924 19421 4

COOKING: GRIDDLES AND GRATES

6558	WEBER Q GRIDDLE	 <ul style="list-style-type: none"> • Porcelain-enameled, cast-iron griddle provides exceptional heat retention and distribution ensuring evenly cooked food • Designed to replace a cooking grate • Fits WEBER Q 100/1000 series gas grills 	<p>\$37.79 \$64.99 \$74.99</p> <p>MASTER CARTON: 1 H: 0.94 W: 15.94 D: 12.0 Wt: 5.79 Cu.Ft.: 0.1</p> <p>INDIVIDUAL CARTON: H: 10.0 W: 15.94 D: 10.94 Wt: 5.79</p> <p>OUT OF CARTON: H: 12.6 W: 8.6 D: 0.5</p>	 <p>0 77924 02164 0</p>
6559	WEBER Q GRIDDLE	 <ul style="list-style-type: none"> • Porcelain-enameled, cast-iron griddle provides exceptional heat retention and distribution ensuring evenly cooked food • Designed to replace a cooking grate • Fits WEBER Q 200/2000 series gas grills 	<p>\$43.36 \$72.99 \$82.99</p> <p>MASTER CARTON: 1 H: 0.82 W: 18.57 D: 14.713 Wt: 8.43 Cu.Ft.: 0.12</p> <p>INDIVIDUAL CARTON: H: 14.13 W: 18.57 D: 0.82 Wt: 8.43</p> <p>OUT OF CARTON: H: 15.3 W: 10.8 D: 0.5</p>	 <p>0 77924 02163 3</p>
6506	WEBER Q GRIDDLE	 <ul style="list-style-type: none"> • Porcelain-enameled, cast-iron griddle provides exceptional heat retention and distribution ensuring evenly cooked food • Designed to replace a cooking grate • Fits WEBER Q 300/3000 series gas grills 	<p>\$48.43 \$79.49 \$89.49</p> <p>MASTER CARTON: 1 H: 2.04 W: 18.67 D: 13.9 Wt: 12.0 Cu.Ft.: 0.3</p> <p>INDIVIDUAL CARTON: H: 13.9 W: 18.67 D: 2.04 Wt: 12.0</p> <p>OUT OF CARTON: H: 17.7 W: 12.9 D: 1.1</p>	 <p>0 77924 07506 3</p>
7598	PORCELAIN-ENAMELED CAST IRON GRIDDLE	 <ul style="list-style-type: none"> • 2-sided, porcelain-enameled, cast-iron griddle • Textured side is ideal for paninis • Flat surface for delicate items such as scallops and shrimp • Fits SMOKEFIRE EX4 and EX6 Wood Pellet Grills, and SPIRIT 300 series gas grills 	<p>\$64.15 \$118.99 \$128.99</p> <p>MASTER CARTON: 1 H: 1.32 W: 21.07 D: 14.32 Wt: 16.08 Cu.Ft.: 0.23</p> <p>INDIVIDUAL CARTON: H: 14.32 W: 21.07 D: 1.32 Wt: 16.08</p> <p>OUT OF CARTON: H: 0.5 W: 12.1 D: 17.4</p>	 <p>0 77924 01914 2</p>
7599	GRIDDLE	 <ul style="list-style-type: none"> • Porcelain-enameled, cast-iron griddle provides exceptional heat retention and distribution ensuring evenly cooked food • Easy to clean semi-gloss enameled surface • Sloped cooking surface helps drain drippings away from food • Fits GENESIS II 300, 400, and 600 series gas grills 	<p>\$64.49 \$118.99 \$128.99</p> <p>MASTER CARTON: 1 H: 2.82 W: 21.63 D: 16.07 Wt: 17.50 Cu.Ft.: 0.56</p> <p>INDIVIDUAL CARTON: H: 16.07 W: 21.63 D: 2.82 Wt: 17.50</p> <p>OUT OF CARTON: H: 18.9 W: 13.2 D: 1.5</p>	 <p>0 77924 05197 5</p>
7404	GRIDDLE	 <ul style="list-style-type: none"> • 2-sided, porcelain-enameled, cast-iron griddle • Textured side is ideal for paninis • Flat surface for delicate items such as scallops and shrimp • Fits SUMMIT 400/600 series (2007 and newer), SUMMIT Silver C/D, SUMMIT Gold A/B/D, SUMMIT Gold A6/B6/C4/D4/D6, and SUMMIT Platinum A6/B6 	<p>\$59.47 \$106.49 \$116.49</p> <p>MASTER CARTON: 1 H: 1.57 W: 23.25 D: 15.07 Wt: 17.44 Cu.Ft.: 0.31</p> <p>INDIVIDUAL CARTON: H: 15.07 W: 23.25 D: 1.57 Wt: 17.44</p> <p>OUT OF CARTON: H: 19.2 W: 11.3 D: 0.9</p>	 <p>0 77924 08349 5</p>













ACCESSORIES

FOB

MAP

MSRP

COOKING: FUEL ACCESSORIES





7666	CHARCOAL HEAT CONTROLLER	\$51.99	\$99.99	\$109.99	 0 77924 19194 7
 <ul style="list-style-type: none"> Up to 7 hours of low-and-slow temp (225°F-275°F) before refueling Diffuser ring maximizes entire 22" grate for indirect low-and-slow Extreme direct high heat for searing; convection heat for crispy wings 	<ul style="list-style-type: none"> Up to 7 hours of low-and-slow temp (225°F-275°F) before refueling Diffuser ring maximizes entire 22" grate for indirect low-and-slow Extreme direct high heat for searing; convection heat for crispy wings 	MASTER CARTON: 3			
		H: 13.5 W: 13.07 D: 20.69 Wt: 21.71 Cu.Ft.: 2.11			
		INDIVIDUAL CARTON:			
		H: 12.25 W: 12.25 D: 6.63 Wt: 6.3			
OUT OF CARTON:					
H: 4.5 W: 18.3 D: 18.3					
7007	FUEL STORAGE BAG	\$20.81	\$33.49	\$38.49	 0 77924 15309 9
 <ul style="list-style-type: none"> Weather resistant material designed to keep fuel dry & BBQ ready Holds up to 20 lbs of wood pellets or charcoal Designed with a window for labeling different fuel Bag folds flat when not in use Unique bottom handle allows best grip for easy pouring 	<ul style="list-style-type: none"> Weather resistant material designed to keep fuel dry & BBQ ready Holds up to 20 lbs of wood pellets or charcoal Designed with a window for labeling different fuel Bag folds flat when not in use Unique bottom handle allows best grip for easy pouring 	MASTER CARTON: 4			
		H: 10.44 W: 6.7 D: 11.62 Wt: 4.84 Cu.Ft.: 0.47			
		INDIVIDUAL CARTON:			
		H: 9.62 W: 6.02 D: 2.32 Wt: 1.04			
OUT OF CARTON:					
H: 18.8 W: 11.8 D: 11.8					
7480	RAPIDFIRE FIRE STARTERS 12PC	\$3.35	\$6.59	\$7.59	 0 77924 12258 3
 <ul style="list-style-type: none"> Convenient single usage packs for grilling, camping, and fire pits Lights easily when wet Ignites charcoal and wood 	<ul style="list-style-type: none"> Convenient single usage packs for grilling, camping, and fire pits Lights easily when wet Ignites charcoal and wood 	MASTER CARTON: 12			
		H: 6.62 W: 9.65 D: 11.93 Wt: 7.91 Cu.Ft.: 0.44			
		INDIVIDUAL CARTON (12):			
		H: 5.8 W: 4.37 D: 1.81 Wt: 0.58			
OUT OF CARTON:					
H: 2.25 W: 1.0 D: 0.5					
7481	RAPIDFIRE FIRE STARTERS 2PC	\$1.25	\$1.99	\$2.49	 0 77924 12260 6
 <ul style="list-style-type: none"> Convenient, grab-n-grill or grab-n-light for immediate use Lights easily when wet Ignites charcoal and wood 	<ul style="list-style-type: none"> Convenient, grab-n-grill or grab-n-light for immediate use Lights easily when wet Ignites charcoal and wood 	MASTER CARTON: 24: 2 CLIP STRIPS WITH 12 EACH			
		H: 2.68 W: 4.14 D: 40.44 Wt: 2.75 Cu.Ft.: 0.25			
		INDIVIDUAL CARTON (2):			
		H: 4.25 W: 3.13 D: 0.79 Wt: 0.09			
OUT OF CARTON:					
H: 2.25 W: 1.0 D: 0.5					
7417	LIGHTER CUBES	\$2.67	\$5.49	\$6.49	 0 77924 07394 6
 <ul style="list-style-type: none"> Light easily, even when wet Use for lighting charcoal grills, smokers, fireplaces, or campfires Box of 24 cubes 	<ul style="list-style-type: none"> Light easily, even when wet Use for lighting charcoal grills, smokers, fireplaces, or campfires Box of 24 cubes 	MASTER CARTON: 12			
		H: 7.94 W: 8.88 D: 13.07 Wt: 10.0 Cu.Ft.: 0.56			
		INDIVIDUAL CARTON:			
		H: 8.5 W: 6.25 D: 1.25 Wt: 0.66			
OUT OF CARTON:					
H: 1.1 W: 1.1 D: 0.8					
7416	RAPIDFIRE CHIMNEY STARTER	\$13.86	\$25.99	\$30.99	 0 77924 07393 9
 <ul style="list-style-type: none"> Convenient and quick way to light charcoal Two handle design provides more control when pouring lit charcoal Works best with WEBER Lighter Cubes and Lighter Packs 	<ul style="list-style-type: none"> Convenient and quick way to light charcoal Two handle design provides more control when pouring lit charcoal Works best with WEBER Lighter Cubes and Lighter Packs 	MASTER CARTON: 4			
		H: 12.76 W: 15.75 D: 21.54 Wt: 14.68 Cu.Ft.: 2.5			
		INDIVIDUAL CARTON:			
		H: 12.0 W: 7.5 D: 12.75 Wt: 3.45			
OUT OF CARTON:					
H: 12.7 W: 8.1 D: 12.5					

FOB



MAP

MSRP

COOKING: FUEL ACCESSORIES

7447	RAPIDFIRE COMPACT CHIMNEY STARTER	\$11.69 \$18.99 \$21.99	 0 77924 01949 4
 <ul style="list-style-type: none"> • Convenient and quick way to light charcoal • Compact design makes it ideal for smaller grills or shorter grilling sessions • Works best with WEBER Lighter Cubes and Lighter Packs 	MASTER CARTON: 4 H: 8.69 W: 12.44 D: 17.38 Wt: 10.88 Cu.Ft.: 1.08		
	INDIVIDUAL CARTON: H: 8.0 W: 5.75 D: 10.25 Wt: 2.5		
	OUT OF CARTON: H: 8.0 W: 5.8 D: 9.6		
	7649	CHARCOAL RAKE	\$12.88 \$24.49 \$29.49
 <ul style="list-style-type: none"> • Designed to safely and conveniently arrange lit charcoal • Stainless steel 	MASTER CARTON: 4 H: 4.69 W: 21.82 D: 9.5 Wt: 3.94 Cu.Ft.: 0.56		
	INDIVIDUAL CARTON: H: 4.0 W: 21.0 D: 1.88 Wt: 0.67		
	OUT OF CARTON: H: 21 W: 3.9 D: 1.9		
	7403	CHAR-BASKETS	\$12.58 \$25.99 \$30.99
 <ul style="list-style-type: none"> • Fill the CHAR-BASKETS with coal to easily and evenly set up for direct or indirect grilling • Set of two baskets • Fits 18 inch WEBER charcoal grills, 22 inch WEBER charcoal grills, and 26 inch WEBER charcoal grills 	MASTER CARTON: 4 H: 17.44 W: 11.07 D: 11.57 Wt: 9.28 Cu.Ft.: 1.29		
	INDIVIDUAL CARTON: H: 16.82 W: 5.38 D: 5.07 Wt: 2.2		
	OUT OF CARTON: H: 14.2 W: 3.6 D: 3.1		

COOKING: ELECTRIC ACCESSORIES

6613	VERSATILITY EXPANSION KIT – LUMIN COMPACT ELECTRIC GRILL	\$44.79 \$69.99 \$79.99	 0 77924 19651 5
 <ul style="list-style-type: none"> • Electric smoker conversion for low-and-slow-cooked favorites like ribs and pork shoulder • Two warming dishes to keep food warm and ready for buffet-style serving • Steam expansion enables use of entire grilling surface to steam seafood and veggies • Includes: Steaming/Smoking Reservoir, Reversible Steam Pan and Warming Dishes (2) 	MASTER CARTON: 1 H: 11.0 W: 12.4 D: 3.55 Wt: 4.3 Cu.Ft.: 0.28		
	INDIVIDUAL CARTON: H: 11.0 W: 12.4 D: 3.55 Wt: 4.3		
	OUT OF CARTON: H: 2.58 W: 8.48 D: 11.12		
	6614	VERSATILITY EXPANSION KIT – LUMIN ELECTRIC GRILL	\$51.19 \$79.99 \$89.99
 <ul style="list-style-type: none"> • Electric smoker conversion for low-and-slow-cooked favorites like ribs and pork shoulder • Two warming dishes to keep food warm and ready for buffet-style serving • Steam expansion enables use of entire grilling surface to steam seafood and veggies • Includes: Steaming/Smoking Reservoir, Reversible Steam Pan and Warming Dishes (2) 	MASTER CARTON: 1 H: 12.2 W: 14.4 D: 3.55 Wt: 5.5 Cu.Ft.: 0.36		
	INDIVIDUAL CARTON: H: 12.2 W: 14.4 D: 3.55 Wt: 5.5		
	OUT OF CARTON: H: 3.79 W: 9.72 D: 13.05		

ACCESSORIES

FOB

MAP

MSRP

COOKING: PELLET ACCESSORIES









190001	WEBER PELLETS - GRILLMASTER BLEND	\$11.48	\$18.99	\$21.99	
	<ul style="list-style-type: none"> • 20 lb bag • All natural hardwood pellets • Moderate flavor: balance and savory with a mild sweet finish 	50 BAGS PER PALLET H: 28.0 W: 40.0 D: 48.0 Wt: 1,075.0 Cu.Ft.: 31.11 INDIVIDUAL CARTON: H: 22.5 W: 16.5 D: 3.0 Wt: 20.0 lbs OUT OF CARTON: H: 22.5 W: 16.5 D: 3.0			
190002	WEBER PELLETS - HICKORY	\$11.48	\$18.99	\$21.99	
	<ul style="list-style-type: none"> • 20 lb bag • All natural hardwood pellets • Moderate flavor: bold, bacon-like flavor 	50 BAGS PER PALLET H: 28.0 W: 40.0 D: 48.0 Wt: 1,075.0 Cu.Ft.: 31.11 INDIVIDUAL CARTON: H: 22.5 W: 16.5 D: 3.0 Wt: 20.0 lbs OUT OF CARTON: H: 22.5 W: 16.5 D: 3.0			
190003	WEBER PELLETS - MESQUITE	\$11.48	\$18.99	\$21.99	
	<ul style="list-style-type: none"> • 20 lb bag • All natural hardwood pellets • Strong flavor: full bodied, big and rich 	50 BAGS PER PALLET H: 28.0 W: 40.0 D: 48.0 Wt: 1,075.0 Cu.Ft.: 31.11 INDIVIDUAL CARTON: H: 22.5 W: 16.5 D: 3.0 Wt: 20.0 lbs OUT OF CARTON: H: 22.5 W: 16.5 D: 3.0			
190004	WEBER PELLETS - APPLE	\$11.48	\$18.99	\$21.99	
	<ul style="list-style-type: none"> • 20 lb bag • All natural hardwood pellets • Mild flavor: aromatic, sweet 	50 BAGS PER PALLET H: 28.0 W: 40.0 D: 48.0 Wt: 1,075.0 Cu.Ft.: 31.11 INDIVIDUAL CARTON: H: 22.5 W: 16.5 D: 3.0 Wt: 20.0 lbs OUT OF CARTON: H: 22.5 W: 16.5 D: 3.0			
190005	WEBER PELLETS - CHERRY	\$11.48	\$18.99	\$21.99	
	<ul style="list-style-type: none"> • 20 lb bag • All natural hardwood pellets • Mild flavor: subtle, fruity, sweet 	50 BAGS PER PALLET H: 28.0 W: 40.0 D: 48.0 Wt: 1,075.0 Cu.Ft.: 31.11 INDIVIDUAL CARTON: H: 22.5 W: 16.5 D: 3.0 Wt: 20.0 lbs OUT OF CARTON: H: 22.5 W: 16.5 D: 3.0			
7004	SMOKEFIRE WET SMOKE KIT	\$14.63	\$24.99	\$29.49	
	<ul style="list-style-type: none"> • Adds moisture to the heat for enhanced wood fired flavor • Creates an indirect cooking space for grilling low-and-slow • Dual purpose design also supports grease management & cleanup • Sits beneath the cooking grate for maximum grilling space • Includes 1 metal rack and 4 foil pans; additional pans sold separately #6416 	MASTER CARTON: 4 H: 14.45 W: 10.24 D: 13.19 Wt: 6.94 Cu.Ft.: 1.12 INDIVIDUAL CARTON: H: 13.59 W: 9.65 D: 3.15 Wt: 1.47 OUT OF CARTON: H: 1.3 W: 7.6 D: 19.3			

FOB

MAP

MSRP

COOKING: PELLET ACCESSORIES

<p>7001</p> 	<p>SMOKEFIRE FOLDING SIDE TABLE</p> <ul style="list-style-type: none"> • Built-in bottle opener • Adds 200 square inches of work space and holds up to 40 lbs of food • Fits with the SMOKEFIRE Premium cover (sold separately) when table is folded up or down • Easily folds down when not in use and can be used for storing the WEBER cutting board (sold separately) • Attaches to left side of grill 	<p>\$51.64 \$85.99 \$95.99</p> <p>MASTER CARTON: 1 H: 3.82 W: 22.05 D: 13.75 Wt: 7.0 Cu.Ft.: 0.7</p> <p>INDIVIDUAL CARTON: H: 13.75 W: 22.05 D: 5.71 Wt: 7.0</p> <p>OUT OF CARTON: H: 3.2 W: 12.3 D: 19.2</p>	 <p>0 77924 15310 5</p>
<p>7002</p> 	<p>SMOKEFIRE EX4 FOLDING FRONT SHELF</p> <ul style="list-style-type: none"> • Attaches to the front of SMOKEFIRE grill, adding 250+ square inches of work space and holds up to 20 lbs of food • Provides extra space for tools, platters, and cutting boards and folds down when not in use • Fits with the SMOKEFIRE Premium cover (sold separately) when table is folded up or down • Also designed to store the upper SMOKEFIRE grill cooking rack 	<p>\$51.64 \$85.99 \$95.99</p> <p>MASTER CARTON: 1 H: 4.00 W: 28.44 D: 10.0 Wt: 7.62 Cu.Ft.: 0.72</p> <p>INDIVIDUAL CARTON: H: 10.0 W: 28.44 D: 4.0 Wt: 7.62</p> <p>OUT OF CARTON: H: 2.5 W: 26.5 D: 10.3</p>	 <p>0 77924 15311 2</p>
<p>7003</p> 	<p>SMOKEFIRE EX6 FOLDING FRONT SHELF</p> <ul style="list-style-type: none"> • Attaches to the front of SMOKEFIRE grill, adding 350+ square inches of work space and holds up to 20 lbs of food per shelf • Provides extra space for tools, platters, and cutting boards and folds down when not in use • Fits with the SMOKEFIRE Premium cover (sold separately) when table is folded up or down • Also designed to store the upper SMOKEFIRE grill cooking rack 	<p>\$95.95 \$147.99 \$157.99</p> <p>MASTER CARTON: 1 H: 6.25 W: 21.0 D: 10.25 Wt: 13.5 Cu.Ft.: 0.8</p> <p>INDIVIDUAL CARTON: H: 6.42 W: 21.0 D: 10.25 Wt: 13.5</p> <p>OUT OF CARTON: H: 2.5 W: 38.9 D: 10.3</p>	 <p>0 77924 15312 9</p>
<p>7009</p> 	<p>SMOKEFIRE GLOW PLUG (1 PCS)</p> <ul style="list-style-type: none"> • Fits SMOKEFIRE EX4 and EX6 Wood Pellet Grills 	<p>\$14.68 \$24.49 \$29.49</p> <p>MASTER CARTON: 12 H: 5.19 W: 6.82 D: 11.57 Wt: 1.28 Cu.Ft.: 0.23</p> <p>INDIVIDUAL CARTON: H: 6.25 W: 2.75 D: 1.38 Wt: 1.0</p> <p>OUT OF CARTON: H: 3.72 W: 0.47 D: 0.47</p>	 <p>0 77924 16180 3</p>



ACCESSORIES

FOB



MAP



MSRP

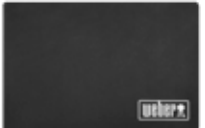

PREP AND SERVE: SPECIALTY ACCESSORIES



7017	SILICONE GRILLING GLOVES	\$15.19	\$24.49	\$29.49			
	<ul style="list-style-type: none"> • Reusable • Food-grade and FDA compliant silicone • Easy-to-clean with soap and water, hand wash only • One size fits most • Heat resistant up to 400° Fahrenheit 	MASTER CARTON: 6					
		H: 11.19	W: 8.0	D: 5.71		Wt: 3.82	Cu.Ft.: 0.0
		INDIVIDUAL CARTON:					
		H: 10.2	W: 7.3	D: 0.8	Wt: 0.6		
		OUT OF CARTON:					
		H: 10.83	W: 7.68	D: N/A			

7696	FLOOR PROTECTION MAT	\$26.68	\$48.99	\$53.99			
	<ul style="list-style-type: none"> • Large surface area protects and covers the surface beneath your grill • Heat resistant and weather resistant • Anti-bacterial and quick drying • Smooth surface makes rolling up and storage easy • Compatible with a variety of grill sizes from an 18" kettle to a 4-burner gas grill 	MASTER CARTON: 6					
		H: 31.7	W: 6.8	D: 10.2		Wt: 3.3	Cu.Ft.: 1.3
		INDIVIDUAL CARTON:					
		H: 31.5	W: 3.2	D: 3.2	Wt: 0.6		
		OUT OF CARTON:					
		H: 0.1	W: 31.5	D: 47.2			

7031	WEBER TRAVELER REVERSIBLE PREP & SERVE	\$23.43	\$37.99	\$42.99			
	<ul style="list-style-type: none"> • Form-fitted to the WEBER TRAVELER grill side table • Reversible for prep and serve options • Non-slip grips keep board in place during use • Knife-friendly surface • Juice groove to collect juices from foods 	MASTER CARTON: 6					
		H: 24.53	W: 8.86	D: 12.21		Wt: 10.07	Cu.Ft.: 1.54
		INDIVIDUAL CARTON:					
		H: 9.3	W: 13.6	D: 0.4	Wt: 0.5		
		OUT OF CARTON:					
		H: 0.52	W: 13.75	D: 9.48			

7032	CUTTING BOARD WITH CATCH BIN	\$22.20	\$36.99	\$41.99			
	<ul style="list-style-type: none"> • Perfect size for prepping on grill side tables • Removable silicone catch bin collects chopped food or waste • Juice groove collects liquids and prevents spills • Silicone catch bin collapses for easy storage • Hand wash recommended 	MASTER CARTON: 6					
		H: 12.8	W: 8.5	D: 14.8		Wt: 11.9	Cu.Ft.: 1.0
		INDIVIDUAL CARTON:					
		H: 0.6	W: 13.6	D: 11.8	Wt: 1.8		
		OUT OF CARTON:					
		H: 0.6	W: 13.6	D: 11.8			

7005	CUTTING BOARD	\$24.54	\$40.49	\$45.49			
	<ul style="list-style-type: none"> • Grooved edges catch meat juices for mess-free carving • Perfect size for prepping & serving on your WEBER grill side table • Knife-friendly and dishwasher safe for easy cleanup • Fits and stores in the SMOKEFIRE Folding Side Table accessory 	MASTER CARTON: 6					
		H: 11.42	W: 18.5	D: 6.5		Wt: 15.33	Cu.Ft.: 0.79
		INDIVIDUAL CARTON:					
		H: 10.75	W: 17.72	D: 0.28	Wt: 2.34		
		OUT OF CARTON:					
		H: 0.3	W: 17.6	D: 10.7			



7008	BUTCHER PAPER	\$31.28	\$53.99	\$63.99			
	<ul style="list-style-type: none"> • Use when smoking meats low-and-slow to retain moisture. • Food-grade butcher paper with food-grade ink, safe to be used on food • Unwaxed, uncoated, unbleached for food safety • 18 inches x 150 feet 	MASTER CARTON: 1					
		H: 4.0	W: 19.13	D: 3.82		Wt: 3.5	Cu.Ft.: 0.17
		INDIVIDUAL CARTON:					
		H: 4.0	W: 19.13	D: 3.82	Wt: 3.5		
		OUT OF CARTON:					
		H: 3.13	W: 18.0	D: 3.13			



FOB

MAP



MSRP



PREP AND SERVE: SPECIALTY ACCESSORIES



6691	PIZZA PADDLE		\$28.04	\$47.99	\$52.99		
 <ul style="list-style-type: none"> • Stainless steel paddle lifts and transports pizzas to and from the grill • Handle rotates for compact storage 	MASTER CARTON: 4	H: 7.75	W: 13.13	D: 16.07	Wt: 8.0		Cu.Ft.: 0.94
	INDIVIDUAL CARTON:	H: 15.0	W: 12.38	D: 1.75	Wt: 1.74		
	OUT OF CARTON:	H: 12.4	W: 24.8	D: 3.1			

6483	BURGER PRESS		\$8.85	\$15.49	\$18.49		
 <ul style="list-style-type: none"> • Designed to make a dimple in patties for flat, uniform burgers • Press designed to make both 1/2 and 1/4 pound patties • Removable handle for easy storage 	MASTER CARTON: 6	H: 12.82	W: 6.07	D: 12.32	Wt: 3.4		Cu.Ft.: 0.55
	INDIVIDUAL CARTON:	H: 5.41	W: 5.11	D: 3.43	Wt: 0.48		
	OUT OF CARTON:	H: 5.5	W: 4.5	D: 3.0			

PREP AND SERVE: MITTS, GLOVES, AND APRONS

6489	CORN HOLDER SET		\$9.01	\$16.99	\$19.99		
 <ul style="list-style-type: none"> • Nylon grip with thumb groove for secure and comfortable handling • Picks interlock for optimized storage in case • Stainless steel • Includes eight corn picks 	MASTER CARTON: 4	H: 8.38	W: 5.25	D: 5.25	Wt: 1.62		Cu.Ft.: 0.13
	INDIVIDUAL CARTON:	H: 5.57	W: 4.19	D: 1.04	Wt: 0.3		
	OUT OF CARTON:	H: 3.8	W: 0.6	D: 0.2			

6488	POTATO NAILS		\$9.50	\$16.99	\$19.99		
 <ul style="list-style-type: none"> • Heat conducted through stainless steel nail provides quick and even cooking of potato • Includes tool for easy removal of nail from potato • Plastic case for easy storage • Set of six 	MASTER CARTON: 4	H: 7.5	W: 6.26	D: 4.07	Wt: 1.42		Cu.Ft.: 0.11
	INDIVIDUAL CARTON:	H: 4.72	W: 5.34	D: 0.84	Wt: 0.27		
	OUT OF CARTON:	H: 4.7	W: 0.6	D: 0.6			

6532	BARBECUE MITT		\$7.76	\$13.49	\$16.49		
 <ul style="list-style-type: none"> • Black mitt with red kettle embroidery • Foldable cuff adjusts length for fit • 100% cotton with heat-resistant liner 	MASTER CARTON: 6	H: 6.44	W: 7.69	D: 16.38	Wt: 3.68		Cu.Ft.: 0.46
	INDIVIDUAL CARTON:	H: 15.62	W: 2.75	D: 1.0	Wt: 0.42		
	OUT OF CARTON:	H: 15.8	W: 8.9	D: 0.8			



ACCESSORIES



FOB



MAP

MSRP



PREP AND SERVE: MITTS, GLOVES, AND APRONS

6533	APRON		\$11.02	\$16.99	\$19.99	
	<ul style="list-style-type: none"> • Black apron, red kettle • Adjustable neckband for a customized fit • Deep front pocket for holding grilling tools • Front towel loop • Machine washable • One size fits most 	MASTER CARTON: 6				
		H: 11.13 W: 7.0 D: 8.0 Wt: 5.0 Cu.Ft.: 0.36				
		INDIVIDUAL CARTON:				
		H: 10.5 W: 6.57 D: 1.38 Wt: 0.56				
		OUT OF CARTON:				
		H: 46.5 W: 25.4 D: 0.2				

6534	APRON		\$11.02	\$16.99	\$19.99	
	<ul style="list-style-type: none"> • Red apron, black kettle • Adjustable neckband for a customized fit • Deep front pocket for holding grilling tools • Front towel loop • Machine washable • One size fits most 	MASTER CARTON: 6				
		H: 11.13 W: 7.0 D: 8.0 Wt: 5.0 Cu.Ft.: 0.36				
		INDIVIDUAL CARTON:				
		H: 10.5 W: 6.57 D: 1.38 Wt: 0.56				
		OUT OF CARTON:				
		H: 46.5 W: 25.4 D: 0.2				

6535	PREMIUM GLOVES		\$27.54	\$48.99	\$53.99	
	<ul style="list-style-type: none"> • Silicone palm for gripping grilling tools • Flexible, heat resistant material for easy handling of grilling tools and grill lid • Size: L/XL 	MASTER CARTON: 6				
		H: 8.94 W: 6.19 D: 14.94 Wt: 3.62 Cu.Ft.: 0.47				
		INDIVIDUAL CARTON:				
		H: 7.88 W: 5.25 D: 2.19 Wt: 0.49				
		OUT OF CARTON:				
		H: 13.5 W: 6.7 D: 0.3				

PREP AND SERVE: SMOKING ACCESSORIES

7576	SMOKER BOX		\$19.72	\$33.49	\$38.49	
	<ul style="list-style-type: none"> • Universal design for smoking on top of the cooking grates • Stainless steel • Fits WEBER Q 200/2000 series and larger gas grills 	MASTER CARTON: 4				
		H: 11.0 W: 5.63 D: 11.38 Wt: 6.76 Cu.Ft.: 0.4				
		INDIVIDUAL CARTON:				
		H: 9.82 W: 4.76 D: 2.44 Wt: 1.46				
		OUT OF CARTON:				
		H: 9.7 W: 4.7 D: 2.0				

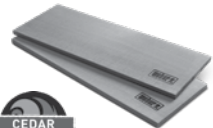

17302	FIRESPICE CEDAR PLANKS		\$5.75	\$10.99	\$13.99	
	<ul style="list-style-type: none"> • Subtle woody flavor • Large planks fit full salmon fillets • Two planks per pack 	MASTER CARTON: 6				
		H: 15.38 W: 6.5 D: 5.32 Wt: 5.85 Cu.Ft.: 0.3				
		INDIVIDUAL CARTON:				
		H: 5.75 W: 0.79 D: 0.4 Wt: 0.9				
		OUT OF CARTON:				
		H: 15.0 W: 5.5 D: 0.3				

FOB

MAP

MSRP

PREP AND SERVE: SMOKING ACCESSORIES

17136	FIRESPICE PECAN WOOD CHIPS	\$2.31	\$4.49	\$5.49	
	Rich sweet flavor 192 cu. in. (0.003 m ³)	MASTER CARTON: 12			
	H: 7.0 W: 19.0 D: 21.0 Wt: 24.0 Cu.Ft.: 1.62	INDIVIDUAL BAG:			
	H: 12.5 W: 8.0 D: 2.5 Wt: 2.0				
17137	FIRESPICE PECAN WOOD CHUNKS	\$3.90	\$7.69	\$8.69	
	Rich sweet flavor 350 cu. in. (0.006 m ³)	MASTER CARTON: 6			
	H: 8.5 W: 15.0 D: 23.0 Wt: 24.0 Cu.Ft.: 1.69	INDIVIDUAL BAG:			
	H: 16.0 W: 10.5 D: 4.0 Wt: 4.0				
17138	FIRESPICE APPLE WOOD CHIPS	\$2.48	\$4.49	\$5.49	
	Subtle sweet flavor 192 cu. in. (0.003 m ³)	MASTER CARTON: 12			
	H: 7.0 W: 19.0 D: 21.0 Wt: 24.0 Cu.Ft.: 1.62	INDIVIDUAL BAG:			
	H: 12.5 W: 8.0 D: 2.5 Wt: 2.0				
17139	FIRESPICE APPLE WOOD CHUNKS	\$4.58	\$7.69	\$8.69	
	Subtle sweet flavor 350 cu. in. (0.006 m ³)	MASTER CARTON: 6			
	H: 8.5 W: 15.0 D: 23.0 Wt: 24.0 Cu.Ft.: 1.69	INDIVIDUAL BAG:			
	H: 16.0 W: 10.5 D: 4.0 Wt: 4.0				
17140	FIRESPICE CHERRY WOOD CHIPS	\$2.48	\$4.49	\$5.49	
	Subtle fruity flavor 192 cu. in. (0.003 m ³)	MASTER CARTON: 12			
	H: 7.0 W: 19.0 D: 21.0 Wt: 24.0 Cu.Ft.: 1.62	INDIVIDUAL BAG:			
	H: 12.5 W: 8.0 D: 2.5 Wt: 2.0				
17142	FIRESPICE CHERRY WOOD CHUNKS	\$4.58	\$7.69	\$8.69	
	Subtle fruity flavor 350 cu. in. (0.006 m ³)	MASTER CARTON: 6			
	H: 8.5 W: 15.0 D: 23.00 Wt: 24.0 Cu.Ft.: 1.69	INDIVIDUAL BAG:			
	H: 16.0 W: 10.5 D: 4.0 Wt: 4.0				













ACCESSORIES

FOB

MAP

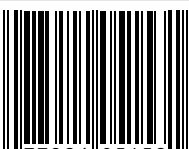
MSRP

PREP AND SERVE: SMOKING ACCESSORIES











<p>17143 FIRESPICE HICKORY WOOD CHIPS</p>  	<p>Rich subtly sweet flavor 192 cu. in. (0.003 m³)</p>	<p>\$2.31 \$4.49 \$5.49</p> <p>MASTER CARTON: 12 H: 7.0 W: 19.0 D: 21.0 Wt: 24.0 Cu.Ft.: 1.62</p> <p>INDIVIDUAL BAG: H: 12.5 W: 8.0 D: 2.5 Wt: 2.0</p>	 0 77924 05151 7
<p>17148 FIRESPICE HICKORY WOOD CHUNKS</p>  	<p>Rich subtly sweet flavor 350 cu. in. (0.006 m³)</p>	<p>\$3.90 \$7.69 \$8.69</p> <p>MASTER CARTON: 6 H: 8.5 W: 15.0 D: 23.0 Wt: 24.0 Cu.Ft.: 1.69</p> <p>INDIVIDUAL BAG: H: 16.0 W: 10.5 D: 4.0 Wt: 4.0</p>	 0 77924 05152 4
<p>17149 FIRESPICE MESQUITE WOOD CHIPS</p>  	<p>Big bold flavor 192 cu. in. (0.003 m³)</p>	<p>\$2.31 \$4.49 \$5.49</p> <p>MASTER CARTON: 12 H: 7.0 W: 19.0 D: 21.0 Wt: 24.0 Cu.Ft.: 1.62</p> <p>INDIVIDUAL BAG: H: 12.5 W: 8.0 D: 2.5 Wt: 2.0</p>	 0 77924 05153 1
<p>17150 FIRESPICE MESQUITE WOOD CHUNKS</p>  	<p>Big bold flavor 350 cu. in. (0.006 m³)</p>	<p>\$3.90 \$7.69 \$8.69</p> <p>MASTER CARTON: 6 H: 8.5 W: 15.0 D: 23.0 Wt: 24.0 Cu.Ft.: 1.69</p> <p>INDIVIDUAL BAG: H: 16.0 W: 10.5 D: 4.0 Wt: 4.0</p>	 0 77924 05155 5

FOB

MAP

MSRP

CARE: CLEANING PRODUCTS

8025	STUBBORN STAIN REMOVER 6OZ	\$7.13 \$13.49 \$16.49	 0 77924 16351 7
	<ul style="list-style-type: none"> Removes stubborn stains on grill associated with grease, varnishing, and carbonization Safe on painted steel and porcelain-enamel Includes scratch-free applicator 	MASTER CARTON: 6 H: 8 W: 5.5 D: 7.5 Wt: 4.0 Cu.Ft.: 0.19	
		INDIVIDUAL CARTON: H: 7.25 W: 2.0 D: 2.0 Wt: 0.7	
8026	GRILL GRATE SCRUBBER	\$5.40 \$10.49 \$13.49	 0 77924 16352 4
	<ul style="list-style-type: none"> Designed for heavy-duty grill cleaning Contoured handle offers a firm, comfortable grip Includes 3 pads for quick and easy replacement 	MASTER CARTON: 6 H: 7.00 W: 5.40 D: 13.25 Wt: 2.0 Cu.Ft.: 0.29	
		INDIVIDUAL CARTON: H: 6.0 W: 3.0 D: 4.0 Wt: 0.25	
8027	GRATE GRILL CLEANER 16OZ	\$5.40 \$10.49 \$13.49	 0 77924 16353 1
	<ul style="list-style-type: none"> Safe for your cooking grate surfaces Formula that is non-toxic and safe on skin Non-flammable, non-corrosive, biodegradable, and phosphate free Works on grills, smokers, ovens, microwaves, and more 	MASTER CARTON: 6 H: 11.5 W: 6.25 D: 8.25 Wt: 8.0 Cu.Ft.: 0.34	
		INDIVIDUAL CARTON: H: 10.85 W: 3.75 D: 2.0 Wt: 1.3	
8028	EXTERIOR GRILL CLEANER 16OZ	\$5.40 \$10.49 \$13.49	 0 77924 16354 8
	<ul style="list-style-type: none"> Streak-free formula cleans exterior grill surfaces Removes water spots, grease, and grime Works great on painted steel, stainless steel, and porcelain-enamel surfaces Use with sponge, towel or high-quality paper towel 	MASTER CARTON: 6 H: 11.5 W: 6.25 D: 8.25 Wt: 8.0 Cu.Ft.: 0.34	
		INDIVIDUAL CARTON: H: 10.85 W: 3.75 D: 2.0 Wt: 1.3	
8029	STAINLESS STEEL POLISH 12OZ	\$9.57 \$18.49 \$21.49	 0 77924 16355 5
	<ul style="list-style-type: none"> Cleans, polishes, and protects grill elements in one step Removes fingerprints, dirt, and water marks Works on indoor stainless-steel appliances Fresh and clean citrus fragrance 	MASTER CARTON: 6 H: 11.5 W: 6.25 D: 8.25 Wt: 5.8 Cu.Ft.: 0.34	
		INDIVIDUAL CARTON: H: 10.85 W: 3.75 D: 2.0 Wt: 0.9	







ACCESSORIES

FOB

MAP

MSRP

CARE: BRUSHES AND TOOLS







6275	12" BAMBOO GRILL BRUSH	\$8.42	\$14.49	\$17.49	
 <ul style="list-style-type: none"> • Designed to easily and efficiently brush away residue • Angled bristle head increase distance from heat for safety • 12 in. long to reach all areas of the grate • Loop to hang brush for easy storage • Compliant to CSA Standards • 2-year warranty 		MASTER CARTON: 12 H: 12.4 W: 5.9 D: 10.4 Wt: 6.6 Cu.Ft.: 0.4 INDIVIDUAL CARTON: H: 11.7 W: 2.4 D: 0.5 Wt: 0.5 OUT OF CARTON: H: 12.0 W: 2.25 D: 2.12			
6276	18" BAMBOO GRILL BRUSH	\$10.22	\$17.99	\$20.99	
 <ul style="list-style-type: none"> • Designed to easily and efficiently brush away residue • Angled bristle head increase distance from heat for safety • 18 in. long to reach all areas of the grate • Loop to hang brush for easy storage • Compliant to CSA Standards • 2-year warrant 		MASTER CARTON: 12 H: 18.7 W: 5.9 D: 10.4 Wt: 7.6 Cu.Ft.: 0.7 INDIVIDUAL CARTON: H: 17.7 W: 2.4 D: 2.1 Wt: 0.6 OUT OF CARTON: H: 17.5 W: 2.25 D: 2.12			
6277	12" THREE-SIDED GRILL BRUSH	\$9.01	\$15.49	\$18.49	
 <ul style="list-style-type: none"> • 3-sided bristle brush design easily cleans larger areas quickly • Shorter sides clean edges and dislodge debris between grates • Comfort-hold handle for leverage when cleaning stuck on food • 12 in. long to reach all areas of the grate • Loop to hang brush for easy storage • 2-year warranty 		MASTER CARTON: 12 H: 13.6 W: 7.7 D: 17.6 Wt: 5.7 Cu.Ft.: 1.1 INDIVIDUAL CARTON: H: 12.3 W: 6.7 D: 1.4 Wt: 0.5 OUT OF CARTON: H: 12.0 W: 7.0 D: 1.0			
6278	18" THREE-SIDED GRILL BRUSH	\$10.10	\$18.99	\$21.99	
 <ul style="list-style-type: none"> • 3-sided bristle brush design easily cleans larger areas quickly • Shorter sides clean edges and dislodge debris between grates • Comfort-hold handle for leverage when cleaning stuck on food • 18 in. long to reach all areas of the grate • Loop to hang brush for easy storage • 2-year warranty 		MASTER CARTON: 12 H: 19.0 W: 7.7 D: 17.6 Wt: 8.2 Cu.Ft.: 1.5 INDIVIDUAL CARTON: H: 17.9 W: 6.6 D: 1.4 Wt: 0.6 OUT OF CARTON: H: 18.0 W: 7.0 D: 1.0			
6279	18" DETAIL BRUSH	\$9.38	\$17.99	\$20.99	
 <ul style="list-style-type: none"> • 18 in. handle helps reach and clean all areas of the grill • Comfort-hold handle for leverage when cleaning stuck on food • Loop to hang brush for easy storage • 2-year warranty 		MASTER CARTON: 12 H: 18.8 W: 5.2 D: 9.4 Wt 7.1 Cu.Ft.: 0.5 INDIVIDUAL CARTON: H: 17.4 W: 2.2 D: 1.5 Wt: 0.5 OUT OF CARTON: H: 17.5 W: 2.25 D: 1.0			
7459	WOOD GRILL SCRAPER	\$20.34	\$33.49	\$38.49	
 <ul style="list-style-type: none"> • Conforms to grates for efficient removal of buildup and residue • Specially designed for easy handling • Made of durable hardwood • Thick, heavy-duty scraper edge for long-lasting use • Fits different grate types 		MASTER CARTON: 6 H: 7.68 W: 6.93 D: 19.61 Wt: 6.06 Cu.Ft.: 0.6 INDIVIDUAL CARTON: H: 17.83 W: 5.59 D: 0.79 Wt: 1.23 OUT OF CARTON: H: 17.83 W: 5.59 D: 0.79			

FOB

MAP

MSRP

CARE: DRIP PANS

6415 DRIP PANS	 <ul style="list-style-type: none"> • Foil liners for grease catch pan • 10 pans per pack • Fits WEBER Q grills, WEBER TRAVELER, SPIRIT gas grills, SPIRIT II gas grills, GENESIS gas grills, GENESIS II 200 & 300 series gas grills, and PULSE electric grills 	<table border="1"> <tr> <td>\$5.40</td> <td>\$10.49</td> <td>\$13.49</td> </tr> <tr> <td colspan="3">MASTER CARTON: 10</td> </tr> <tr> <td>H: 9.57</td> <td>W: 12.69</td> <td>D: 9.69</td> </tr> <tr> <td>Wt: 4.0</td> <td colspan="2">Cu.Ft.: 0.68</td> </tr> <tr> <td colspan="3">INDIVIDUAL CARTON:</td> </tr> <tr> <td>H: 10.0</td> <td>W: 6.0</td> <td>D: 2.5</td> </tr> <tr> <td>Wt: 0.32</td> <td colspan="2"></td> </tr> <tr> <td colspan="3">OUT OF CARTON:</td> </tr> <tr> <td>H: 8.6</td> <td>W: 6.0</td> <td>D: 1.3</td> </tr> </table>	\$5.40	\$10.49	\$13.49	MASTER CARTON: 10			H: 9.57	W: 12.69	D: 9.69	Wt: 4.0	Cu.Ft.: 0.68		INDIVIDUAL CARTON:			H: 10.0	W: 6.0	D: 2.5	Wt: 0.32			OUT OF CARTON:			H: 8.6	W: 6.0	D: 1.3	 <p>0 77924 07475 2</p>
\$5.40	\$10.49	\$13.49																												
MASTER CARTON: 10																														
H: 9.57	W: 12.69	D: 9.69																												
Wt: 4.0	Cu.Ft.: 0.68																													
INDIVIDUAL CARTON:																														
H: 10.0	W: 6.0	D: 2.5																												
Wt: 0.32																														
OUT OF CARTON:																														
H: 8.6	W: 6.0	D: 1.3																												
6498 DRIP PANS	 <ul style="list-style-type: none"> • Foil liners for grease catch pan • 10 pans per pack • Fits SMOKEFIRE EX4 and EX6, GENESIS II 400 and 600 series gas grills, SUMMIT 400/600 series, and SUMMIT Gold/Platinum 6-burner models 	<table border="1"> <tr> <td>\$10.23</td> <td>\$15.49</td> <td>\$18.49</td> </tr> <tr> <td colspan="3">MASTER CARTON: 4</td> </tr> <tr> <td>H: 11.82</td> <td>W: 5.57</td> <td>D: 11.94</td> </tr> <tr> <td>Wt: 4.06</td> <td colspan="2">Cu.Ft.: 0.45</td> </tr> <tr> <td colspan="3">INDIVIDUAL CARTON:</td> </tr> <tr> <td>H: 11.38</td> <td>W: 4.75</td> <td>D: 2.86</td> </tr> <tr> <td>Wt: 1.02</td> <td colspan="2"></td> </tr> <tr> <td colspan="3">OUT OF CARTON:</td> </tr> <tr> <td>H: 11.0</td> <td>W: 5.0</td> <td>D: 2.5</td> </tr> </table>	\$10.23	\$15.49	\$18.49	MASTER CARTON: 4			H: 11.82	W: 5.57	D: 11.94	Wt: 4.06	Cu.Ft.: 0.45		INDIVIDUAL CARTON:			H: 11.38	W: 4.75	D: 2.86	Wt: 1.02			OUT OF CARTON:			H: 11.0	W: 5.0	D: 2.5	 <p>0 77924 12981 0</p>
\$10.23	\$15.49	\$18.49																												
MASTER CARTON: 4																														
H: 11.82	W: 5.57	D: 11.94																												
Wt: 4.06	Cu.Ft.: 0.45																													
INDIVIDUAL CARTON:																														
H: 11.38	W: 4.75	D: 2.86																												
Wt: 1.02																														
OUT OF CARTON:																														
H: 11.0	W: 5.0	D: 2.5																												
6416 FOIL PANS	 <ul style="list-style-type: none"> • Disposable pans for transporting food to and from the grill • Use with rotisseries, roast racks, or between CHAR-BASKETS for indirect cooking • Fits SMOKEFIRE Wet Smoke Kit • 10 pans per pack 	<table border="1"> <tr> <td>\$8.28</td> <td>\$13.49</td> <td>\$16.49</td> </tr> <tr> <td colspan="3">MASTER CARTON: 6</td> </tr> <tr> <td>H: 14.07</td> <td>W: 9.94</td> <td>D: 13.69</td> </tr> <tr> <td>Wt: 6.0</td> <td colspan="2">Cu.Ft.: 1.1</td> </tr> <tr> <td colspan="3">INDIVIDUAL CARTON:</td> </tr> <tr> <td>H: 13.19</td> <td>W: 9.32</td> <td>D: 3.5</td> </tr> <tr> <td>Wt: 0.8</td> <td colspan="2"></td> </tr> <tr> <td colspan="3">OUT OF CARTON:</td> </tr> <tr> <td>H: 13.1</td> <td>W: 9.1</td> <td>D: 2.0</td> </tr> </table>	\$8.28	\$13.49	\$16.49	MASTER CARTON: 6			H: 14.07	W: 9.94	D: 13.69	Wt: 6.0	Cu.Ft.: 1.1		INDIVIDUAL CARTON:			H: 13.19	W: 9.32	D: 3.5	Wt: 0.8			OUT OF CARTON:			H: 13.1	W: 9.1	D: 2.0	 <p>0 77924 07476 9</p>
\$8.28	\$13.49	\$16.49																												
MASTER CARTON: 6																														
H: 14.07	W: 9.94	D: 13.69																												
Wt: 6.0	Cu.Ft.: 1.1																													
INDIVIDUAL CARTON:																														
H: 13.19	W: 9.32	D: 3.5																												
Wt: 0.8																														
OUT OF CARTON:																														
H: 13.1	W: 9.1	D: 2.0																												



ACCESSORIES



FOB



MAP

MSRP



CARE: COVERS - ELECTRIC



7181	PREMIUM COVER	\$46.22	\$83.99	\$93.99			
 <ul style="list-style-type: none"> • UV inhibitors in fabric resist fading • Breathable and water resistant to help protect grill from the elements • Fastening straps keep the cover in place • Fits PULSE 2000 grill with cart 	MASTER CARTON: 4	H: 10.6	W: 8.1	D: 11.7		Wt: 6.4	Cu.Ft.: 0.6
	INDIVIDUAL CARTON:	H: 10.1	W: 2.6	D: 7.3		Wt: 1.3	
	OUT OF CARTON:	H: 36.6	W: 20.3	D: 45.2			

7197	PREMIUM GRILL COVER	\$21.85	\$39.99	\$44.99			
 <ul style="list-style-type: none"> • Fits LUMIN/LUMIN COMPACT electric grill without stand • Resists fading with UV-inhibiting fabric • Shields grill from rain and snow with weather-resistant fabric • Secures in place with 2 drawstring pulls 	MASTER CARTON: 4	H: 4.65	W: 10.95	D: 9.5		Wt: 2.65	Cu.Ft.: 0.28
	INDIVIDUAL CARTON:	H: 7.5	W: 3.95	D: 2.5		Wt: 0.45	
	OUT OF CARTON:	H: 10.5	W: 20.3	D: 18.5			

7196	PREMIUM GRILL COVER	\$38.29	\$74.99	\$84.99			
 <ul style="list-style-type: none"> • Fits LUMIN/LUMIN COMPACT electric grill on the stand • Resists fading with UV-inhibiting fabric • Shields grill from rain and snow with weather-resistant fabric • Secures in place with 4 fastening straps that connect to stand 	MASTER CARTON: 5	H: 13.5	W: 7.5	D: 9.8		Wt: 9.8	Cu.Ft.: 0.57
	INDIVIDUAL CARTON:	H: 10.5	W: 6.65	D: 2.45		Wt: 1.95	
	OUT OF CARTON:	H: 30.5	W: 23.5	D: 23.5			

CARE: COVERS - TRAVELER

7770	PREMIUM GRILL COVER	\$35.74	\$54.99	\$64.99			
 <p>NEW</p> <ul style="list-style-type: none"> • Weather-resistant fabric shields your grill from rain and snow • Made from durable, polyester material • Lightweight design makes covering and uncovering easy • Compatible with WEBER TRAVELER grill • Fastening straps keep the cover secure once in place 	MASTER CARTON: 4	H: 11.7	W: 10.65	D: 8.15		Wt: 7.9	Cu.Ft.: 0.59
	INDIVIDUAL CARTON:	H: 11.2	W: 7.35	D: 2.7		Wt: 1.65	
	OUT OF CARTON:	H: 39.3	W: 22.0	D: 56.6			





7030	CARGO PROTECTOR	\$36.51	\$61.49	\$71.49			
 <ul style="list-style-type: none"> • Form-fitted to the WEBER TRAVELER grill for optimal grease and grime containment • Grease-resistant fabric protects trunk interior or cargo space • Integrated storage pockets for grilling tools • Folds flat and small for compact storage 	MASTER CARTON: 4	H: 20.99	W: 8.04	D: 12.41		Wt: 6.99	Cu.Ft.: 1.21
	INDIVIDUAL CARTON:	H: 10.0	W: 7.3	D: 2.7		Wt: 1.6	
	OUT OF CARTON:	H: 13.81	W: 40.55	D: 23.0			

FOB



MAP

MSRP

CARE: COVERS - GRIDDLES

7035	GRIDDLE STORAGE BAG 3B	\$32.49 \$49.99 \$59.99	 0 77924 19938 7
 <ul style="list-style-type: none"> • Weather-resistant fabric shields your full-size griddle from the elements • Made from durable material • Lightweight design and double zipper make inserting and removing the full-size griddle easy • Compatible with the SPIRIT or GENESIS Full-Size Griddle – 300 Series 	MASTER CARTON: 4	H: 10.65 W: 8.15 D: 11.7 Wt: 5.3 Cu.Ft.: 0.58	
	INDIVIDUAL CARTON:	H: 10.1 W: 7.25 D: 2.65 Wt: 1.32	
	OUT OF CARTON:	H: 19.0 W: 27.0 D: 2.0	
	7036	GRIDDLE STORAGE BAG 4B	\$38.99 \$59.99 \$69.99
 <ul style="list-style-type: none"> • Weather-resistant fabric shields your full-size griddle from the elements • Made from durable material • Lightweight design and double zipper make inserting and removing the full-size griddle easy • Compatible with the SPIRIT or GENESIS Full-Size Griddle – 400 Series 	MASTER CARTON: 4	H: 10.65 W: 8.15 D: 11.7 Wt: 5.3 Cu.Ft.: 0.58	
	INDIVIDUAL CARTON:	H: 10.1 W: 7.25 D: 2.65 Wt: 1.32	
	OUT OF CARTON:	H: 19.0 W: 34.0 D: 2.0	
	7771	PREMIUM GRIDDLE COVER	\$52.00 \$99.99 \$109.99
 <ul style="list-style-type: none"> • Weather-resistant fabric shields your grill from the elements. • Made from durable material • Lightweight design makes covering and uncovering easy • Compatible with the WEBER GRIDDLE 28" • Fastening straps keep the cover secure once in place 	MASTER CARTON: 3	H: 10.65 W: 8.15 D: 11.7 Wt: 5.3 Cu.Ft.: 0.59	
	INDIVIDUAL CARTON:	H: 11.2 W: 7.35 D: 2.7 Wt: 1.0	
	OUT OF CARTON:	H: 43.4 W: 63.0 D: 25.6	

CARE: COVERS - PELLET

7190	PREMIUM GRILL COVER	\$43.69 \$72.99 \$82.99	 0 77924 12965 0
 <ul style="list-style-type: none"> • UV inhibitors in fabric resist fading • Breathable and water resistant to help protect grill from the elements • Fastening straps keep the cover in place • Fits SMOKEFIRE EX4 Wood Pellet grill 	MASTER CARTON: 3	H: 10.63 W: 8.23 D: 11.62 Wt: 8.21 Cu.Ft.: 0.58	
	INDIVIDUAL CARTON:	H: 9.63 W: 7.26 D: 3.55 Wt: 2.5	
	OUT OF CARTON:	H: 43.3 W: 58.3 D: 32.1	
	7191	PREMIUM GRILL COVER	\$56.90 \$94.99 \$104.99
 <ul style="list-style-type: none"> • UV inhibitors in fabric resist fading • Breathable and water resistant to help protect grill from the elements • Fastening straps keep the cover in place • Fits SMOKEFIRE EX6 Wood Pellet grill 	MASTER CARTON: 2	H: 10.44 W: 7.94 D: 8.81 Wt: 6.38 Cu.Ft.: 0.42	
	INDIVIDUAL CARTON:	H: 10.25 W: 4.0 D: 7.3 Wt: 2.8	
	OUT OF CARTON:	H: 41.8 W: 69.2 D: 32.1	







ACCESSORIES

FOB

MAP

MSRP

CARE: COVERS - GAS











7110	GRILL COVER	<ul style="list-style-type: none"> • UV inhibitors in fabric resist fading • Breathable and water resistant to help protect grill from the elements • Drawstring keeps the cover in place • Fits WEBER Q 100/1000 series grills 	<p>\$12.92 \$21.99 \$24.99</p> <p>MASTER CARTON: 4 H: 4.63 W: 10.94 D: 9.5 Wt: 2.43 Cu.Ft.: 0.27</p> <p>INDIVIDUAL CARTON: H: 7.5 W: 3.94 D: 2.5 Wt: 0.45</p> <p>OUT OF CARTON: H: 12.4 W: 26.3 D: 17.3</p>	 <p>0 77924 03545 6</p>
7111	GRILL COVER	<ul style="list-style-type: none"> • UV inhibitors in fabric resist fading • Breathable and water resistant to help protect grill from the elements • Drawstring keeps the cover in place • Fits WEBER Q 200/2000 series grills 	<p>\$15.29 \$27.99 \$32.99</p> <p>MASTER CARTON: 4 H: 4.63 W: 10.94 D: 9.5 Wt: 2.62 Cu.Ft.: 0.27</p> <p>INDIVIDUAL CARTON: H: 7.5 W: 3.94 D: 2.5 Wt: 0.52</p> <p>OUT OF CARTON: H: 12.6 W: 32.3 D: 18.9</p>	 <p>0 77924 03546 3</p>
7112	PREMIUM GRILL COVER	<ul style="list-style-type: none"> • UV inhibitors in fabric resist fading • Breathable and water resistant to help protect grill from the elements • Fastening straps keep the cover in place • Fits WEBER Q 2000 series grills with Q cart and WEBER Q 3000 series grills 	<p>\$28.59 \$55.99 \$65.99</p> <p>MASTER CARTON: 4 H: 10.63 W: 8.13 D: 11.69 Wt: 5.0 Cu.Ft.: 0.58</p> <p>INDIVIDUAL CARTON: H: 11.19 W: 7.32 D: 2.69 Wt: 1.95</p> <p>OUT OF CARTON: H: 56.6 W: 39.3 D: 22.0</p>	 <p>0 77924 03547 0</p>
7113	PREMIUM GRILL COVER	<ul style="list-style-type: none"> • UV inhibitors in fabric resist fading • Breathable and water resistant to help protect grill from the elements • Fastening straps keep the cover in place • Fits WEBER Q 100/1000 and WEBER Q 200/2000 grills with the Q portable cart 	<p>\$23.74 \$44.99 \$49.99</p> <p>MASTER CARTON: 4 H: 10.63 W: 8.13 D: 11.69 Wt: 6.74 Cu.Ft.: 0.58</p> <p>INDIVIDUAL CARTON: H: 11.19 W: 7.32 D: 2.69 Wt: 1.31</p> <p>OUT OF CARTON: H: 32.2 W: 35.0 D: 17.3</p>	 <p>0 77924 03548 7</p>
7137	TANK COVER	<ul style="list-style-type: none"> • UV inhibitors in fabric resists fading • Breathable, weather resistant fabric • Protects cylinder from the elements • Drawstring keeps the cover in place • Fits standard size 20 lb. LP tank (tank sold separately) 	<p>\$8.47 \$14.49 \$17.49</p> <p>MASTER CARTON: 4 H: 9.5 W: 10.9 D: 4.6 Wt: 2.25 Cu.Ft.: 0.3</p> <p>INDIVIDUAL CARTON: H: 8.75 W: 4.0 D: 2.5 Wt: 0.4</p> <p>OUT OF CARTON: H: 16.5 W: 13.9 D: 13.9</p>	 <p>0 77924 05199 9</p>
7138	PREMIUM GRILL COVER	<ul style="list-style-type: none"> • UV inhibitors in fabric resist fading • Breathable and water resistant to help protect grill from the elements • Fastening straps keep the cover in place • Fits SPIRIT 200 and SPIRIT II 200 series gas grills 	<p>\$43.68 \$78.49 \$88.49</p> <p>MASTER CARTON: 3 H: 10.63 W: 8.13 D: 13.13 Wt: 6.83 Cu.Ft.: 0.65</p> <p>INDIVIDUAL CARTON: H: 11.25 W: 7.25 D: 4.0 Wt: 2.18</p> <p>OUT OF CARTON: H: 42.0 W: 48.0 D: 27.0</p>	 <p>0 77924 05874 5</p>

FOB

MAP

MSRP

CARE: COVERS - GAS GRILL

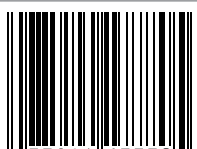
<p>7139 PREMIUM GRILL COVER</p> 	<ul style="list-style-type: none"> • UV inhibitors in fabric resist fading • Breathable and water resistant to help protect grill from the elements • Fastening straps keep the cover in place • Fits SPIRIT 300 and SPIRIT II 300 series gas grills 	<p>\$47.73 \$89.49 \$99.49</p> <p>MASTER CARTON: 3</p> <p>H: 10.63 W: 8.07 D: 13.13 Wt: 9.09 Cu.Ft.: 0.65</p> <p>INDIVIDUAL CARTON:</p> <p>H: 11.25 W: 7.25 D: 4.0 Wt: 2.3</p> <p>OUT OF CARTON:</p> <p>H: 42.0 W: 52.0 D: 27.0</p>	 <p>0 77924 05875 2</p>
<p>207138 PREMIUM GRILL COVER - 8 PACK</p> 	<ul style="list-style-type: none"> • UV inhibitors in fabric resist fading • Breathable and water resistant to help protect grill from the elements • Fastening straps keep the cover in place • Fits SPIRIT 200 and SPIRIT II 200 series gas grills 	<p>\$43.68 \$78.49 \$88.49</p> <p>MASTER CARTON: 8</p> <p>H: 27.5 W: 8.13 D: 17.3 Wt: 22.0 Cu.Ft.: 2.2</p> <p>INDIVIDUAL CARTON:</p> <p>H: 11.25 W: 7.25 D: 4.0 Wt: 2.18</p> <p>OUT OF CARTON:</p> <p>H: 42.0 W: 48.0 D: 27.0</p>	 <p>0 77924 05877 6</p>
<p>207139 PREMIUM GRILL COVER - 8 PACK</p> 	<ul style="list-style-type: none"> • UV inhibitors in fabric resist fading • Breathable and water resistant to help protect grill from the elements • Fastening straps keep the cover in place • Fits SPIRIT 300 and SPIRIT II 300 series gas grills 	<p>\$47.73 \$89.49 \$99.49</p> <p>MASTER CARTON: 8</p> <p>H: 27.5 W: 8.1 D: 17.3 Wt: 22.6 Cu.Ft.: 2.2</p> <p>INDIVIDUAL CARTON:</p> <p>H: 11.25 W: 7.25 D: 4.0 Wt: 2.3</p> <p>OUT OF CARTON:</p> <p>H: 42.0 W: 52.0 D: 27.0</p>	 <p>0 77924 05878 3</p>
<p>7754 PREMIUM GRILL COVER - 8 PACK</p> 	<ul style="list-style-type: none"> • UV inhibitors in fabric resist fading • Breathable and water resistant to help protect grill from the elements • Fastening straps keep the cover in place • Fits GENESIS 300 series gas grills, and GENESIS II 300 series gas grills 	<p>\$54.78 \$100.99 \$110.99</p> <p>MASTER CARTON: 8</p> <p>H: 8.3 W: 17.3 D: 27.5 Wt: 26.7 Cu.Ft.: 2.3</p> <p>INDIVIDUAL CARTON:</p> <p>H: 10.1 W: 7.3 D: 4.0 Wt: 2.9</p> <p>OUT OF CARTON:</p> <p>H: 43.4 W: 63 D: 25.6</p>	 <p>0 77924 17767 5</p>
<p>7755 PREMIUM GRILL COVER - 8 PACK</p> 	<ul style="list-style-type: none"> • UV inhibitors in fabric resist fading • Breathable and water resistant to help protect grill from the elements • Fastening straps keep the cover in place • Fits GENESIS II 400 series gas grills, and GENESIS 400 series gas grills 	<p>\$58.48 \$106.49 \$116.49</p> <p>MASTER CARTON: 8</p> <p>H: 17.3 W: 28.8 D: 28.8 Wt: 28.8 Cu.Ft.: 2.4</p> <p>INDIVIDUAL CARTON:</p> <p>H: 10.1 W: 7.3 D: 4.0 Wt: 3.2</p> <p>OUT OF CARTON:</p> <p>H: 43.4 W: 70.8 D: 25.6</p>	 <p>0 77924 17768 2</p>
<p>7757 PREMIUM GRILL COVER</p> 	<ul style="list-style-type: none"> • UV inhibitors in fabric resist fading • Breathable and water resistant to help protect grill from the elements • Fastening straps keep the cover in place • Fits GENESIS 300 series gas grills, and GENESIS II 300 series gas grills 	<p>\$54.78 \$100.99 \$110.99</p> <p>MASTER CARTON: 2</p> <p>H: 10.6 W: 8.1 D: 9.0 Wt: 6.5 Cu.Ft.: 0.5</p> <p>INDIVIDUAL CARTON:</p> <p>H: 10.1 W: 7.3 D: 4.0 Wt: 2.9</p> <p>OUT OF CARTON:</p> <p>H: 43.4 W: 63 D: 25.6</p>	 <p>0 77924 17770 5</p>









ACCESSORIES

FOB

MAP

MSRP

CARE: COVERS - GAS GRILL

7758	PREMIUM GRILL COVER	\$58.48	\$106.49	\$116.49	 0 77924 17771 2
 <ul data-bbox="300 346 657 493" style="list-style-type: none"> • UV inhibitors in fabric resist fading • Breathable and water resistant to help protect grill from the elements • Fastening straps keep the cover in place • Fits GENESIS II 400 series gas grills, and GENESIS 400 series gas grills 	MASTER CARTON: 2 H: 10.6 W: 8.1 D: 9.0 Wt: 7.1 Cu.Ft.: 0.5				
	INDIVIDUAL CARTON: H: 10.1 W: 7.3 D: 4.0 Wt: 3.2				
	OUT OF CARTON: H: 43.4 W: 70.8 D: 25.6				
7108	PREMIUM GRILL COVER	\$62.25	\$111.99	\$121.99	 0 77924 03288 2
 <ul data-bbox="300 640 657 766" style="list-style-type: none"> • UV inhibitors in fabric resist fading • Breathable and water resistant to help protect grill from the elements • Fastening straps keep the cover in place • Fits SUMMIT 400 series gas grills 	MASTER CARTON: 2 H: 10.57 W: 8.19 D: 11.57 Wt: 6.0 Cu.Ft.: 0.57				
	INDIVIDUAL CARTON: H: 11.25 W: 7.25 D: 5.25 Wt: 2.18				
	OUT OF CARTON: H: 47.0 W: 66.8 D: 26.8				
7109	PREMIUM GRILL COVER	\$62.25	\$111.99	\$121.99	 0 77924 03290 5
 <ul data-bbox="300 934 657 1060" style="list-style-type: none"> • UV inhibitors in fabric resist fading • Breathable and water resistant to help protect grill from the elements • Fastening straps keep the cover in place • Fits SUMMIT 600 series gas grills 	MASTER CARTON: 2 H: 10.57 W: 8.19 D: 11.57 Wt: 7.92 Cu.Ft.: 0.57				
	INDIVIDUAL CARTON: H: 11.25 W: 7.25 D: 5.25 Wt: 3.21				
	OUT OF CARTON: H: 47 W: 74.8 D: 26.8				
7561	GRILL COVER	\$43.14	\$79.49	\$89.49	 0 77924 00914 3
 <ul data-bbox="300 1228 657 1333" style="list-style-type: none"> • Protects your grill work surfaces from the elements • Velcro straps secure cover to the grill • Fits SUMMIT grill center 	MASTER CARTON: 1 H: 2.63 W: 12.69 D: 10.25 Wt: 3.19 Cu.Ft.: 0.19				
	INDIVIDUAL CARTON: H: 10.25 W: 12.69 D: 2.63 Wt: 3.19				
	OUT OF CARTON: H: 29.0 W: 91.1 D: 21.5				

FOB

MAP

MSRP

CARE: COVERS - CHARCOAL GRILL

<p>7154 SMOKEY JOE BAG</p> 	<ul style="list-style-type: none"> • Comes with an adjustable, padded shoulder strap • Fits SMOKEY JOE and SMOKEY JOE Premium portable grills 	<p>\$16.43 \$29.99 \$34.99</p> <p>MASTER CARTON: 2</p> <p>H: 9.94 W: 8.68 D: 5.19 Wt: 2.15 Cu.Ft.: 0.25</p> <p>INDIVIDUAL CARTON:</p> <p>H: 9.13 W: 8.0 D: 2.25 Wt: 0.92</p> <p>OUT OF CARTON:</p> <p>H: 19.6 W: 18.9 D: 16.5</p>	 <p>0 77924 03549 4</p>
<p>7175 GRILL COVER</p> 	<ul style="list-style-type: none"> • Breathable and water resistant to help protect grill from rusting • Fastening strap keeps the cover in place • Fits 18 inch WEBER charcoal grills 	<p>\$10.12 \$19.49 \$22.49</p> <p>MASTER CARTON: 5</p> <p>H: 9.88 W: 7.44 D: 8.88 Wt: 5.0 Cu.Ft.: 0.37</p> <p>INDIVIDUAL CARTON:</p> <p>H: 9.07 W: 6.63 D: 1.5 Wt: 0.6</p> <p>OUT OF CARTON:</p> <p>H: 32.0 W: 18.5 D: 24.0</p>	 <p>0 77924 04814 2</p>
<p>7176 GRILL COVER</p> 	<ul style="list-style-type: none"> • Breathable and water resistant to help protect grill from rusting • Fastening strap keeps the cover in place • Fits 22 inch WEBER charcoal grills 	<p>\$11.22 \$21.99 \$24.99</p> <p>MASTER CARTON: 5</p> <p>H: 9.88 W: 7.44 D: 8.88 Wt: 6.0 Cu.Ft.: 0.37</p> <p>INDIVIDUAL CARTON:</p> <p>H: 9.07 W: 6.63 D: 1.5 Wt: 0.8</p> <p>OUT OF CARTON:</p> <p>H: 35.0 W: 23.5 D: 28.5</p>	 <p>0 77924 04815 9</p>
<p>7148 PREMIUM GRILL COVER</p> 	<ul style="list-style-type: none"> • UV inhibitors in fabric resist fading • Breathable and water resistant to help protect grill from the elements • Fastening strap keeps the cover in place • Fits 18 inch WEBER charcoal grills 	<p>\$19.77 \$38.99 \$43.99</p> <p>MASTER CARTON: 4</p> <p>H: 10.63 W: 8.13 D: 9.0 Wt: 4.7 Cu.Ft.: 0.45</p> <p>INDIVIDUAL CARTON:</p> <p>H: 9.75 W: 7.25 D: 1.94 Wt: 0.92</p> <p>OUT OF CARTON:</p> <p>H: 32.5 W: 20.0 D: 20.5</p>	 <p>0 77924 03272 1</p>
<p>7150 PREMIUM GRILL COVER</p> 	<ul style="list-style-type: none"> • UV inhibitors in fabric resist fading • Breathable and water resistant to help protect grill from the elements • Fastening strap keeps the cover in place • Fits 22 inch WEBER charcoal grills 	<p>\$23.25 \$45.99 \$50.99</p> <p>MASTER CARTON: 4</p> <p>H: 10.63 W: 8.13 D: 11.69 Wt: 6.08 Cu.Ft.: 0.58</p> <p>INDIVIDUAL CARTON:</p> <p>H: 9.75 W: 7.25 D: 2.63 Wt: 1.16</p> <p>OUT OF CARTON:</p> <p>H: 35.0 W: 27.0 D: 25.0</p>	 <p>0 77924 03278 3</p>
<p>7151 PREMIUM GRILL COVER</p> 	<ul style="list-style-type: none"> • UV inhibitors in fabric resist fading • Breathable and water resistant to help protect grill from the elements • Fastening strap keeps the cover in place • Fits PERFORMER 22 inch charcoal grills with folding table 	<p>\$31.25 \$55.99 \$65.99</p> <p>MASTER CARTON: 3</p> <p>H: 10.63 W: 8.13 D: 9.0 Wt: 5.54 Cu.Ft.: 0.45</p> <p>INDIVIDUAL CARTON:</p> <p>H: 11.25 W: 7.25 D: 2.75 Wt: 1.52</p> <p>OUT OF CARTON:</p> <p>H: 42.0 W: 40.0 D: 33.0</p>	 <p>0 77924 03280 6</p>









ACCESSORIES

FOB

MAP

MSRP

CARE: COVERS - CHARCOAL GRILL













7152	PREMIUM GRILL COVER	\$39.15	\$72.99	\$82.99		
		<ul style="list-style-type: none"> • UV inhibitors in fabric resist fading • Breathable and water resistant to help protect grill from the elements • Fastening strap keeps the cover in place • Fits PERFORMER Premium and Deluxe 22 inch charcoal grills 			MASTER CARTON: 3 H: 10.63 W: 8.13 D: 9.0 Wt: 6.2 Cu.Ft.: 0.45 INDIVIDUAL CARTON: H: 11.25 W: 7.25 D: 2.65 Wt: 1.68 OUT OF CARTON: H: 46.7 W: 48.5 D: 39.8	0 77924 03281 3
7153	PREMIUM GRILL COVER	\$30.85	\$55.99	\$65.99		
		<ul style="list-style-type: none"> • UV inhibitors in fabric resist fading • Breathable and water resistant to help protect grill from the elements • Fastening strap keeps the cover in place • Fits 26 inch WEBER charcoal grills 			MASTER CARTON: 2 H: 10.63 W: 8.13 D: 6.26 Wt: 3.92 Cu.Ft.: 0.31 INDIVIDUAL CARTON: H: 11.25 W: 7.25 D: 2.65 Wt: 1.3 OUT OF CARTON: H: 39.0 W: 31.5 D: 31.5	0 77924 03283 7
7173	PREMIUM GRILL COVER	\$44.80	\$87.49	\$97.49		
		<ul style="list-style-type: none"> • UV inhibitors in fabric resist fading • Breathable and water resistant to help protect grill from the elements • Fastening strap keeps the cover in place • Fits SUMMIT Kamado E6 grill and SUMMIT charcoal grill 			MASTER CARTON: 2 H: 10.63 W: 8.13 D: 6.26 Wt: 4.21 Cu.Ft.: 0.31 INDIVIDUAL CARTON: H: 11.25 W: 7.25 D: 2.65 Wt: 1.69 OUT OF CARTON: H: 43.0 W: 35.8 D: 34.0	0 77924 04165 5
7174	PREMIUM GRILL COVER	\$52.77	\$100.99	\$110.99		
		<ul style="list-style-type: none"> • UV inhibitors in fabric resist fading • Breathable and water resistant to help protect grill from the elements • Fastening strap keeps the cover in place • Fits SUMMIT Kamado S6 Grill Center and SUMMIT Grill Center charcoal grill 			MASTER CARTON: 2 H: 10.63 W: 8.13 D: 9.0 Wt: 6.08 Cu.Ft.: 0.45 INDIVIDUAL CARTON: H: 11.25 W: 7.25 D: 4.0 Wt: 2.19 OUT OF CARTON: H: 44.5 W: 53.0 D: 36.0	0 77924 04175 4

FOB

MAP

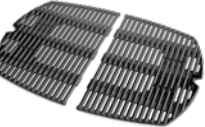
MSRP

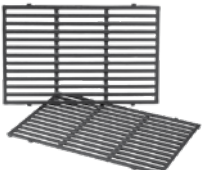
CARE: REPLACEMENT PARTS - GAS GRILL

6414	REPLACEMENT CASTER	 <ul style="list-style-type: none"> Fits the following grills: • GENESIS 1000-5000 • GENESIS A/B/C (2002-2003 model years) • GENESIS Gold B/C (model year 2002 and newer) • Platinum I • RANCH kettle • PERFORMER (prior to 2005 model year) 	<p>\$7.10 \$10.99 \$13.99</p> <p>MASTER CARTON: 6</p> <p>H: 6.94 W: 6.44 D: 9.57 Wt: 1.98 Cu.Ft.: 0.24</p> <p>INDIVIDUAL CARTON:</p> <p>H: 6.1 W: 2.75 D: 2.75 Wt: 0.33</p> <p>OUT OF CARTON:</p> <p>H: 2.5 W: 1.5 D: 4.6</p>	 <p>0 77924 07474 5</p>
6501	WEBER Q ADAPTER HOSE	 <ul style="list-style-type: none"> • Connects to a Type I (791) cylinder connection on a 20 lb. LP tank • Fits Baby Q gas grill, WEBER Q 100/1000 series grills, WEBER Q gas grill, WEBER Q 200/2000 series grills, GO-ANYWHERE gas grills, and WEBER TRAVELER gas grill 	<p>\$26.63 \$43.99 \$48.99</p> <p>MASTER CARTON: 4</p> <p>H: 10.32 W: 8.44 D: 13.5 Wt: 6.0 Cu.Ft.: 0.68</p> <p>INDIVIDUAL CARTON:</p> <p>H: 9.25 W: 7.5 D: 3.0 Wt: 1.5</p> <p>OUT OF CARTON:</p> <p>H: 6.8 W: 1.5 D: 0.5</p>	 <p>0 77924 07501 8</p>
7644	COOKING GRATES	 <ul style="list-style-type: none"> • Porcelain-enameled, cast-iron cooking grates • Includes bracket support for WEBER Q 100 series gas grills • Fits WEBER Q 100/1000 series gas grills 	<p>\$50.72 \$85.99 \$95.99</p> <p>MASTER CARTON: 1</p> <p>H: 1.25 W: 20.88 D: 16.0 Wt: 11.3 Cu.Ft.: 0.24</p> <p>INDIVIDUAL CARTON:</p> <p>H: 16.0 W: 20.88 D: 1.25 Wt: 11.3</p> <p>OUT OF CARTON:</p> <p>H: 17.0 W: 12.7 D: 0.5</p>	 <p>0 77924 03883 9</p>
7645	COOKING GRATES	 <ul style="list-style-type: none"> • Porcelain-enameled, cast-iron cooking grates • Includes bracket support for WEBER Q 200 series gas grills • Fits WEBER Q 200/2000 series gas grills 	<p>\$60.46 \$98.49 \$108.49</p> <p>MASTER CARTON: 1</p> <p>H: 1.25 W: 25.38 D: 18.63 Wt: 17.53 Cu.Ft.: 0.34</p> <p>INDIVIDUAL CARTON:</p> <p>H: 18.63 W: 25.38 D: 1.25 Wt: 17.53</p> <p>OUT OF CARTON:</p> <p>H: 21.5 W: 15.3 D: 0.5</p>	 <p>0 77924 03884 6</p>
7646	COOKING GRATES	 <ul style="list-style-type: none"> • Porcelain-enameled, cast-iron cooking grates • Fits WEBER Q 300/3000 series gas grills 	<p>\$71.19 \$117.49 \$127.49</p> <p>MASTER CARTON: 1</p> <p>H: 2.13 W: 21.88 D: 16.38 Wt: 20.3 Cu.Ft.: 0.44</p> <p>INDIVIDUAL CARTON:</p> <p>H: 16.38 W: 21.88 D: 2.13 Wt: 20.3</p> <p>OUT OF CARTON:</p> <p>H: 25 W: 17.8 D: 0.5</p>	 <p>0 77924 03885 3</p>
7524	GAS GRILL COOKING GRATES	 <ul style="list-style-type: none"> • Porcelain-enameled, cast-iron cooking grates • Fits GENESIS 300 series gas grills • Does not fit GENESIS II 300 series gas grills 	<p>\$72.90 \$135.99 \$145.99</p> <p>MASTER CARTON: 1</p> <p>H: 2.38 W: 23.07 D: 16.63 Wt: 17.3 Cu.Ft.: 0.52</p> <p>INDIVIDUAL CARTON:</p> <p>H: 16.63 W: 23.07 D: 2.38 Wt: 17.3</p> <p>OUT OF CARTON:</p> <p>H: 19.5 W: 12.9 D: 0.5</p>	 <p>0 77924 07437 0</p>



ACCESSORIES



FOB

MAP



MSRP

CARE: REPLACEMENT PARTS - GAS GRILL

7639	GAS GRILL COOKING GRATES	\$76.55	\$135.49	\$145.49			
 <ul style="list-style-type: none"> • Stainless steel cooking grates • Fits SPIRIT 300 series gas grills • Does not fit SPIRIT II 300 series gas grills 	MASTER CARTON: 1			0 77924 03222 6			
	H: 1.38	W: 20.25	D: 14.07			Wt: 11.12	Cu.Ft.: 0.22
	INDIVIDUAL CARTON:						
H: 14.07			W: 20.25	D: 1.38	Wt: 11.12		
OUT OF CARTON:							
H: 17.3			W: 11.8	D: 0.5			

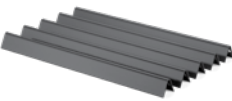
7528	GAS GRILL COOKING GRATES	\$114.56	\$184.99	\$204.99			
 <ul style="list-style-type: none"> • Stainless steel cooking grates • Fits GENESIS 300 series gas grills • Does not fit GENESIS II 300 series gas grills 	MASTER CARTON: 1			0 77924 07441 7			
	H: 2.0	W: 22.11	D: 16.07			Wt: 14.1	Cu.Ft.: 0.41
	INDIVIDUAL CARTON:						
H: 16.07			W: 22.11	D: 2.0	Wt: 14.1		
OUT OF CARTON:							
H: 19.5			W: 12.9	D: 0.6			

7534	FLAVORIZER BARS	\$34.61	\$65.99	\$75.99			
 <ul style="list-style-type: none"> • Porcelain-enameled • Catch drippings that smoke and sizzle, adding a smoky flavor to food • Set of five bars • Fits SPIRIT 200 series (with side-mounted control panel), SPIRIT 500, and GENESIS Silver A 	MASTER CARTON: 1			0 77924 07447 9			
	H: 3.25	W: 25.5	D: 5.5			Wt: 6.5	Cu.Ft.: 0.26
	INDIVIDUAL CARTON:						
H: 5.5			W: 25.5	D: 3.25	Wt: 6.5		
OUT OF CARTON:							
H: 21.5			W: 1.7	D: 1.7			

7536	FLAVORIZER BARS	\$35.20	\$65.99	\$75.99			
 <ul style="list-style-type: none"> • Porcelain-enameled • Catch drippings that smoke and sizzle, adding a smoky flavor to food • Set of five bars • Fits SPIRIT 300 series gas grills (with side-mounted control panel) 	MASTER CARTON: 1			0 77924 07449 3			
	H: 3.25	W: 25.5	D: 5.5			Wt: 8.3	Cu.Ft.: 0.26
	INDIVIDUAL CARTON:						
H: 5.5			W: 25.5	D: 3.25	Wt: 8.3		
OUT OF CARTON:							
H: 22.5			W: 2.3	D: 2.3			

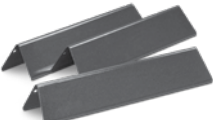
7635	FLAVORIZER BARS	\$29.54	\$52.49	\$62.49			
 <ul style="list-style-type: none"> • Porcelain-enameled • Catch drippings that smoke and sizzle, adding a smoky flavor to food • Set of three bars • Fits SPIRIT 200 series gas grills (with front-mounted control panel) 	MASTER CARTON: 1			0 77924 03216 5			
	H: 5.75	W: 17.5	D: 5.0			Wt: 5.0	Cu.Ft.: 0.29
	INDIVIDUAL CARTON:						
H: 5.75			W: 17.5	D: 5.0	Wt: 5.0		
OUT OF CARTON:							
H: 15.3			W: 3.5	D: 2.5			

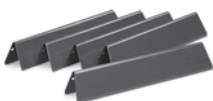





7636	FLAVORIZER BARS	\$38.91	\$65.99	\$75.99			
 <ul style="list-style-type: none"> • Porcelain-enameled • Catch drippings that smoke and sizzle, adding a smoky flavor to food • Set of five bars • Fits SPIRIT 300 series gas grills (with front-mounted control panel) 	MASTER CARTON: 1			0 77924 03217 2			
	H: 5.75	W: 17.5	D: 5.0			Wt: 5.0	Cu.Ft.: 0.29
	INDIVIDUAL CARTON:						
H: 5.75			W: 17.5	D: 5.0	Wt: 5.0		
OUT OF CARTON:							
H: 15.3			W: 2.6	D: 2.5			

FOB

MAP

MSRP

CARE: REPLACEMENT PARTS - GAS GRILL

7539	FLAVORIZER BARS	 <ul style="list-style-type: none"> • Porcelain-enameled • Catch drippings that smoke and sizzle, adding a smoky flavor to food • Set of five bars • Fits GENESIS 300 series gas grills (with side-mounted control panel) 	<p>\$37.26 \$65.99 \$75.99</p> <p>MASTER CARTON: 1 H: 3.63 W: 25.88 D: 6.0 Wt: 9.1 Cu.Ft.: 0.32</p> <p>INDIVIDUAL CARTON: H: 6.0 W: 25.88 D: 3.63 Wt: 9.1</p> <p>OUT OF CARTON: H: 24.5 W: 2.2 D: 2.3</p>	 <p>0 77924 07452 3</p>
7621	FLAVORIZER BARS	 <ul style="list-style-type: none"> • Porcelain-enameled • Catch drippings that smoke and sizzle, adding a smoky flavor to food • Set of five bars • Fits GENESIS 300 series gas grills (with front-mounted control panel) 	<p>\$37.26 \$65.99 \$75.99</p> <p>MASTER CARTON: 1 H: 3.44 W: 25.63 D: 5.88 Wt: 4.5 Cu.Ft.: 0.3</p> <p>INDIVIDUAL CARTON: H: 5.88 W: 25.63 D: 3.44 Wt: 4.5</p> <p>OUT OF CARTON: H: 17.6 W: 2.3 D: 2.2</p>	 <p>0 77924 02317 0</p>
7620	FLAVORIZER BARS	 <ul style="list-style-type: none"> • Stainless steel • Catch drippings that smoke and sizzle, adding a smoky flavor to food • Set of five bars • Fits GENESIS 300 series gas grills (with front-mounted control panel) 	<p>\$81.87 \$143.99 \$153.99</p> <p>MASTER CARTON: 1 H: 3.44 W: 25.63 D: 5.88 Wt: 4.5 Cu.Ft.: 0.3</p> <p>INDIVIDUAL CARTON: H: 5.88 W: 25.63 D: 3.44 Wt: 4.5</p> <p>OUT OF CARTON: H: 17.5 W: 2.2 D: 2.3</p>	 <p>0 77924 02316 3</p>
7502	21 INCH HOSE AND REGULATOR KIT	 <p>Fits</p> <ul style="list-style-type: none"> • GENESIS Silver C • GENESIS Gold B/C • GENESIS Platinum B/C • SUMMIT Silver/Gold/Platinum 	<p>\$23.70 \$45.99 \$50.99</p> <p>MASTER CARTON: 4 H: 10.32 W: 8.44 D: 13.57 Wt: 6.0 Cu.Ft.: 0.68</p> <p>INDIVIDUAL CARTON: H: 9.25 W: 7.6 D: 3.1 Wt: 1.42</p> <p>OUT OF CARTON: H: 21.0 W: 4.0 D: 0.5</p>	 <p>0 77924 07415 8</p>
7627	30 INCH HOSE AND REGULATOR KIT	 <ul style="list-style-type: none"> • Fits GENESIS 300 series gas grills (front mounted control panel) • Fits SUMMIT 400/600 series gas grills 	<p>\$25.05 \$45.99 \$50.99</p> <p>MASTER CARTON: 4 H: 10.32 W: 8.44 D: 13.57 Wt: 6.54 Cu.Ft.: 0.68</p> <p>INDIVIDUAL CARTON: H: 9.29 W: 7.54 D: 3.04 Wt: 1.64</p> <p>OUT OF CARTON: H: 31.2 W: 4.0 D: 0.6</p>	 <p>0 77924 02328 6</p>
7507	STAINLESS STEEL BURNER TUBE SET	 <p>Fits the following gas grills:</p> <ul style="list-style-type: none"> • SPIRIT 500 • GENESIS Silver A 	<p>\$37.09 \$58.99 \$68.99</p> <p>MASTER CARTON: 4 H: 5.44 W: 31.75 D: 6.69 Wt: 12.31 Cu.Ft.: 0.66</p> <p>INDIVIDUAL CARTON: H: 2.9 W: 30.1 D: 2.3 Wt: 2.5</p> <p>OUT OF CARTON: H: 27.0 W: 1.0 D: 1.0</p>	 <p>0 77924 07420 2</p>













ACCESSORIES

FOB

MAP

MSRP

CARE: REPLACEMENT PARTS - GAS GRILL







7508	STAINLESS STEEL BURNER TUBE SET	\$46.50	\$71.99	\$81.99		
		Fits the following gas grills: <ul style="list-style-type: none"> • SPIRIT 700 • GENESIS Silver B/C • GENESIS Gold (2002 and newer models) 			MASTER CARTON: 4	0 77924 07421 9
		H: 5.44 W: 31.75 D: 6.69 Wt: 13.2 Cu.Ft.: 0.66				
		INDIVIDUAL CARTON:				
		H: 2.9 W: 30.1 D: 2.3 Wt: 3.3				
		OUT OF CARTON:				
		H: 28.0 W: 1.0 D: 1.0				
7509	IGNITER KIT	\$10.32	\$18.99	\$21.99		
		Fits the following gas grills: <ul style="list-style-type: none"> • SPIRIT (does not fit front-mounted control panel models) • GENESIS (prior to 2002 model year) • Platinum I/II 			MASTER CARTON: 6	0 77924 07423 6
		H: 6.94 W: 6.44 D: 9.57 Wt: 1.10 Cu.Ft.: 0.24				
		INDIVIDUAL CARTON:				
		H: 6.10 W: 2.75 D: 2.75 Wt: 0.35				
		OUT OF CARTON:				
		H: 19.1 W: 1 D: 1				
7510	IGNITER KIT	\$10.40	\$18.99	\$21.99		
		Fits the following gas grills: <ul style="list-style-type: none"> • GENESIS Silver/Gold/Platinum 2002 and newer (does not fit GENESIS Silver/Gold C models after 2003) 			MASTER CARTON: 6	0 77924 07423 3
		H: 6.94 W: 6.44 D: 9.57 Wt: 2.04 Cu.Ft.: 0.24				
		INDIVIDUAL CARTON:				
		H: 6.1 W: 2.75 D: 2.75 Wt: 0.34				
		OUT OF CARTON:				
		H: 7.5 W: 2.7 D: 2.7				
7628	IGNITER KIT	\$30.72	\$52.99	\$62.99		
		<ul style="list-style-type: none"> • Battery included • Fits GENESIS 310 and 320 gas grills (with front-mounted control panel) 			MASTER CARTON: 6	0 77924 02329 3
		H: 8.88 W: 8.19 D: 9.44 Wt: 6.10 Cu.Ft.: 0.39				
		INDIVIDUAL CARTON:				
		H: 8.00 W: 3.63 D: 2.75 Wt: 0.87				
		OUT OF CARTON:				
		H: 3.3 W: 3.1 D: 2.4				
7629	IGNITER KIT	\$31.11	\$52.99	\$62.99		
		<ul style="list-style-type: none"> • Battery included • Fits GENESIS 330 gas grill (with front-mounted control panel) 			MASTER CARTON: 6	0 77924 02330 9
		H: 8.88 W: 8.19 D: 9.44 Wt: 6.30 Cu.Ft.: 0.39				
		INDIVIDUAL CARTON:				
		H: 8.00 W: 3.63 D: 2.80 Wt: 0.90				
		OUT OF CARTON:				
		H: 3.2 W: 3.1 D: 2.3				
7642	IGNITER KIT	\$28.07	\$53.99	\$63.99		
		<ul style="list-style-type: none"> • Battery included • Fits SPIRIT 210 and SPIRIT 310 gas grills (with front-mounted control panel) 			MASTER CARTON: 6	0 77924 03223 3
		H: 8.88 W: 8.19 D: 9.44 Wt: 5.22 Cu.Ft.: 0.39				
		INDIVIDUAL CARTON:				
		H: 8.0 W: 3.63 D: 2.8 Wt: 0.72				
		OUT OF CARTON:				
		H: 9.2 W: 3.6 D: 2.7				

FOB



MAP

MSRP

CARE: REPLACEMENT PARTS - GAS GRILL

7513	WARMING RACK		\$12.42	\$19.99	\$22.99	 0 77924 07426 4
 <p>Fits the following gas grills:</p> <ul style="list-style-type: none"> • SPIRIT 700 • GENESIS 1000-5500 • GENESIS Silver B/C • GENESIS Gold/Platinum • Platinum I/II 			MASTER CARTON: 4 H: 2.82 W: 26.0 D: 5.5 Wt: 7.0 Cu.Ft.: 0.23			
			INDIVIDUAL CARTON: H: 4.75 W: 24.8 D: 0.63 Wt: 1.42			
			OUT OF CARTON: H: 24.9 W: 4.7 D: 0.4			
7641	WARMING RACK		\$15.28	\$24.49	\$29.49	 0 77924 03294 3
 <ul style="list-style-type: none"> • Keeps food warm while food grills below • Fits SPIRIT 300 series gas grills 			MASTER CARTON: 4 H: 3.63 W: 26.25 D: 6.25 Wt: 6.32 Cu.Ft.: 0.34			
			INDIVIDUAL CARTON: H: 0.75 W: 26.0 D: 6.0 Wt: 1.5			
			OUT OF CARTON: H: 24.8 W: 4.6 D: 2.3			
7515	CATCH PAN AND HOLDER		\$21.22	\$33.99	\$38.99	 0 77924 07428 8
 <p>Fits the following gas grills:</p> <ul style="list-style-type: none"> • SPIRIT (does not fit front-mounted control panel models) • GENESIS 1000-5500 • GENESIS Silver/Gold/Platinum • Platinum I/II • SUMMIT (except Gold/Platinum 6-burner) 			MASTER CARTON: 4 H: 10.32 W: 8.44 D: 13.57 Wt: 8.0 Cu.Ft.: 0.68			
			INDIVIDUAL CARTON: H: 9.5 W: 7.6 D: 3.1 Wt: 2.0			
			OUT OF CARTON: H: 9.1 W: 7.3 D: 3.0			

CARE: REPLACEMENT PARTS - CHARCOAL GRILL

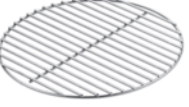
7439	CHARCOAL GRATE		\$6.00	\$11.99	\$14.99	 0 77924 07404 2
 <p>Fits 14 inch WEBER charcoal grills</p>			MASTER CARTON: 5 H: 3.38 W: 11.86 D: 11.86 Wt: 5.0 Cu.Ft.: 0.26			
			INDIVIDUAL CARTON: H: 10.63 W: 10.63 D: 0.63 Wt: 1.0			
			OUT OF CARTON: H: 10.5 W: 10.5 D: 0.3			
7440	CHARCOAL GRATE		\$8.39	\$14.99	\$17.99	 0 77924 07405 9
 <p>Fits 18 inch WEBER charcoal grills (does not fit SMOKEY MOUNTAIN COOKER smoker)</p>			MASTER CARTON: 5 H: 3.38 W: 15.07 D: 15.07 Wt: 9.78 Cu.Ft.: 0.44			
			INDIVIDUAL CARTON: H: 13.63 W: 13.63 D: 0.63 Wt: 1.8			
			OUT OF CARTON: H: 13.5 W: 13.5 D: 0.4			









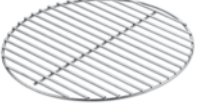

ACCESSORIES

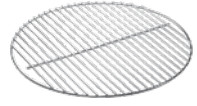
FOB

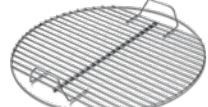
MAP

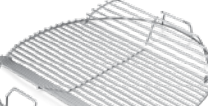
MSRP

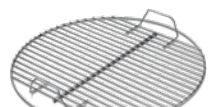
CARE: REPLACEMENT PARTS - CHARCOAL GRILL

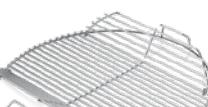
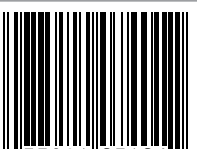



<p>7441 CHARCOAL GRATE</p> 	<p>Fits 22 inch WEBER charcoal grills (does not fit SMOKEY MOUNTAIN COOKER smoker)</p>	<p>\$10.52 \$19.99 \$22.99</p> <p>MASTER CARTON: 5 H: 3.38 W: 19.25 D: 19.5 Wt: 17.22 Cu.Ft.: 0.73</p> <p>INDIVIDUAL CARTON: H: 18.0 W: 18.0 D: 0.63 Wt: 3.2</p> <p>OUT OF CARTON: H: 17.0 W: 17.0 D: 0.4</p>	 0 77924 07406 6
<p>7431 CHARCOAL GRATE</p> 	<p>Fits 14 inch WEBER charcoal grills (does not fit SMOKEY MOUNTAIN COOKER smoker)</p>	<p>\$7.87 \$12.99 \$15.99</p> <p>MASTER CARTON: 5 H: 3.38 W: 15.07 D: 15.07 Wt: 8.3 Cu.Ft.: 0.44</p> <p>INDIVIDUAL CARTON: H: 13.63 W: 13.63 D: 0.36 Wt: 1.37</p> <p>OUT OF CARTON: H: 13.7 W: 13.7 D: 0.3</p>	 0 77924 07396 0
<p>7432 CHARCOAL GRATE</p> 	<p>Fits 18 inch WEBER charcoal grills (does not fit SMOKEY MOUNTAIN COOKER smoker)</p>	<p>\$11.79 \$23.99 \$26.99</p> <p>MASTER CARTON: 5 H: 3.38 W: 19.25 D: 19.5 Wt: 16.0 Cu.Ft.: 0.73</p> <p>INDIVIDUAL CARTON: H: 17.5 W: 17.5 D: 2.25 Wt: 3.2</p> <p>OUT OF CARTON: H: 17.5 W: 17.5 D: 2.0</p>	 0 77924 07397 7
<p>7433 HINGED COOKING GRATE</p> 	<p>Fits 18 inch WEBER charcoal grills (does not fit SMOKEY MOUNTAIN COOKER smoker)</p>	<p>\$14.54 \$24.99 \$29.99</p> <p>MASTER CARTON: 5 H: 3.38 W: 19.25 D: 19.5 Wt: 16.0 Cu.Ft.: 0.73</p> <p>INDIVIDUAL CARTON: H: 17.5 W: 17.5 D: 2.25 Wt: 3.2</p> <p>OUT OF CARTON: H: 17.2 W: 17.5 D: 1.7</p>	 0 77924 07398 4
<p>7435 CHARCOAL GRATE</p> 	<p>Fits 22 inch WEBER charcoal grills (does not fit SMOKEY MOUNTAIN COOKER smoker)</p>	<p>\$14.68 \$25.99 \$30.99</p> <p>MASTER CARTON: 5 H: 3.38 W: 22.88 D: 22.88 Wt: 31.67 Cu.Ft.: 1.02</p> <p>INDIVIDUAL CARTON: H: 21.5 W: 21.5 D: 2.25 Wt: 6.0</p> <p>OUT OF CARTON: H: 21.5 W: 21.5 D: 2.0</p>	 0 77924 07400 4
<p>7436 HINGED COOKING GRATE</p> 	<p>Fits 22 inch WEBER charcoal grills (does not fit SMOKEY MOUNTAIN COOKER smoker)</p>	<p>\$19.24 \$39.99 \$44.99</p> <p>MASTER CARTON: 5 H: 3.38 W: 22.88 D: 22.88 Wt: 26.22 Cu.Ft.: 1.02</p> <p>INDIVIDUAL CARTON: H: 21.5 W: 21.5 D: 1.75 Wt: 5.0</p> <p>OUT OF CARTON: H: 21.5 W: 21.5 D: 1.8</p>	 0 77924 07401 1

FOB

MAP

MSRP

CARE: REPLACEMENT PARTS - CHARCOAL GRILL

7444	22 INCH ONE-TOUCH CLEANING SYSTEM KIT	\$14.85	\$24.99	\$29.99	 0 77924 01097 2
 <ul style="list-style-type: none"> • Contains three damper blades, one damper control rod, one H-drive assembly, one washer, and an instruction sheet • Fits 22 inch ONE-TOUCH, 22 inch ORIGINAL KETTLE, and PERFORMER charcoal grills 		MASTER CARTON: 6			
		H: 10.94 W: 4.94 D: 9.44 Wt: 5.8 Cu.Ft.: 0.29			
		INDIVIDUAL CARTON:			
		H: 10.1 W: 4.5 D: 1.5 Wt: 0.95			
		OUT OF CARTON:			
		H: 9.2 W: 1.6 D: 0.8			
7478	KETTLE TOOL HOOK HANDLE	\$7.86	\$13.49	\$16.49	 0 77924 02283 8
 <ul style="list-style-type: none"> • Update your kettle with a new handle • Equipped with two tool hooks 		MASTER CARTON: 6			
		H: 6.51 W: 8.13 D: 13.44 Wt: 2.1 Cu.Ft.: 0.41			
		INDIVIDUAL CARTON:			
		H: 5.55 W: 7.2 D: 1.88 Wt: 0.35			
		OUT OF CARTON:			
		H: 0.6 W: 1.2 D: 1.4			











ACCESSORIES

FOB

MAP

MSRP

MERCHANDISE: CARTS AND TABLES



6618	LUMIN COMPACT STAND WITH SIDE TABLE	\$101.99	\$149.99	\$159.99	 0 77924 19655 3	
NEW		<ul style="list-style-type: none"> • Collapsible design for simple setup, breakdown and storage • Built-in hooks to easily access grilling tools • Side table provides room to prep and serve • Durable, fade-resistant material maintains color and longevity 				MASTER CARTON: 1 H: 19.8 W: 21.3 D: 10.0 Wt: 12.5 Cu.Ft.: 2.44
		INDIVIDUAL CARTON: H: 19.8 W: 21.3 D: 10.0 Wt: 12.5				
		OUT OF CARTON: H: 26.8 W: 21.6 D: 21.9				
6619	LUMIN STAND WITH SIDE TABLE	\$122.39	\$179.99	\$199.99	 0 77924 19656 0	
NEW		<ul style="list-style-type: none"> • Collapsible design for simple setup, breakdown and storage • Built-in hooks to easily access grilling tools • Side table provides room to prep and serve • Durable, fade-resistant material maintains color and longevity 				MASTER CARTON: 1 H: 21.35 W: 25.0 D: 10.35 Wt: 16.5 Cu.Ft.: 3.2
		INDIVIDUAL CARTON: H: 21.15 W: 25.0 D: 10.3 Wt: 17.5				
		OUT OF CARTON: H: 28.1 W: 25.0 D: 21.8				
6557	WEBER Q PORTABLE CART	\$64.36	\$117.49	\$127.49	 0 77924 02161 9	
		<ul style="list-style-type: none"> • Grill attaches to cart and locks in place • Folds down while grill is attached for easy portability • Built-in wire transport handle • Fits WEBER Q 1000/2000 series grills 				MASTER CARTON: 1 H: 4.2 W: 36.0 D: 22.0 Wt: 13.58 Cu.Ft.: 1.92
		INDIVIDUAL CARTON: H: 22.0 W: 36.0 D: 4.2 Wt: 13.58				
		OUT OF CARTON H x W x D (EXCLUDES GRILL): Raised (28.2 x 21 x 25) Collapsed (28.2 x 29.7 x 6.5)				
6525	WEBER Q CART	\$110.17	\$159.99	\$179.99	 0 77924 02162 6	
		<ul style="list-style-type: none"> • Heavy-duty cart with three integrated tool hooks • Side handle for easy mobility • Storage area for tools and accessories • Screen discretely keeps 20 lb. LP tank out of view (tank not included) • Includes adapter hose for 20 lb. LP tank • Fits WEBER Q 2000 series grills 				MASTER CARTON: 1 H: 8.82 W: 33.0 D: 19.13 Wt: 25.5 Cu.Ft.: 3.22
		INDIVIDUAL CARTON: H: 19.13 W: 33.0 D: 8.82 Wt: 25.5				
		OUT OF CARTON (EXCLUDES GRILL): H: 35.5 W: 21.5 D: 29.7				
6012001	PULSE 2000 CART	\$165.70	\$219.99	\$269.99	 0 77924 15303 7	
		<ul style="list-style-type: none"> • Heavy-duty cart with three integrated tool hooks • Fits PULSE 2000 series grills 				MASTER CARTON: 1 H: 27.08 W: 24.11 D: 31.16 Wt: 33.0 Cu.Ft.: 11.8
		INDIVIDUAL CARTON: H: 35.0 W: 44.0 D: 23.0 Wt: 33.0				
		OUT OF CARTON (EXCLUDES GRILL): H: 35.0 W: 44.0 D: 23.0				



FOB

MAP

MSRP

MERCHANDISE: TOOL HOOKS AND GRILL LIGHTS



7401 TOOL HOOKS 	<ul style="list-style-type: none"> Hang essential grilling tools for easy access and organization of your backyard workspace Fits 18 inch and 22 inch WEBER charcoal grills 	\$3.70 \$8.49 \$9.49	 0 77924 06864 5
		MASTER CARTON: 6 H: 8.82 W: 8.19 D: 9.44 Wt: 2.17 Cu.Ft.: 0.39	
		INDIVIDUAL CARTON: H: 8.0 W: 3.63 D: 2.75 Wt: 0.25	
		OUT OF CARTON: H: 7.0 W: 2.0 D: 3.5	



7661 GRILL 'N GO HANDLE LIGHT 	<ul style="list-style-type: none"> LED illuminates the entire cooking surface Detachable to shine extra light where you need it Motion sensor with an on/off switch saves battery life Fits round handles on WEBER SPIRIT, GENESIS and SUMMIT gas grill models year 2007 and newer. Fits all SPIRIT II, GENESIS II grill models Includes 3 AAA batteries / 20 hours 	\$24.22 \$40.49 \$45.49	 0 77924 11405 2
		MASTER CARTON: 4 H: 5.83 W: 4.88 D: 8.07 Wt: 1.82 Cu.Ft.: 0.13	
		INDIVIDUAL CARTON: H: 4.53 W: 4.33 D: 1.78 Wt: 0.41	
		OUT OF CARTON: H: 4.2 W: 2.5 D: 3.0	

MERCHANDISE: COOKBOOKS

FOB

MSRP

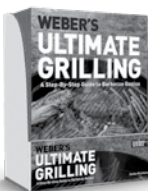
9558 	WEBER'S ULTIMATE GRILLING Hard cover; 352 pages	\$15.57 \$41.99	Master Carton: 10 H: 6.1 W: 17.9 D: 11.6 Wt: 3.5 Cu.Ft.: 0.7	 0 77924 10071 0
			Individual Book: H: 11.13 W: 8.75 D: 1.07 Wt: 0.04	



209558 	WEBER'S ULTIMATE GRILLING DISPLAYER 1 displayer / 5 cookbooks	\$77.85	Master Carton: 1 H: 9.75 W: 12.0 D: 12.07 Wt: 17.7 Cu.Ft.: 0.81	 0 77924 10072 7
			Individual Book: H: 11.13 W: 8.75 D: 1.07 Wt: 0.04	



ACCESSORIES

FOB

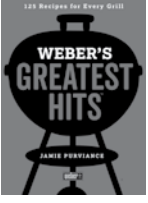

MSRP



MERCHANDISE: COOKBOOKS



9557		WEBER'S GREATEST HITS Soft cover; 320 pages	\$13.93	\$34.00	Master Carton: 10	 0 77924 05729 8
					H: 9.6 W: 9.5 D: 11.8 Wt: 29.0 Cu.Ft.: 0.6	
Individual Book:						
H: 11.38 W: 9.0 D: 0.75 Wt: 2.9						

209557		WEBER'S GREATEST HITS DISPLAYER 1 displayer / 5 cookbooks	\$69.67		Master Carton: 1	 0 77924 05873 8
					H: 4.63 W: 9.57 D: 11.94 Wt: 13.38 Cu.Ft.: 0.30	
Individual Book:						
H: 11.38 W: 9.0 D: 0.75 Wt: 2.9						

9554		WEBER'S NEW AMERICAN BARBECUE Soft cover; 304 pages	\$13.93	\$34.00	Master Carton: 10	 0 77924 04193 8
					H: 10.0 W: 8.8 D: 11.2 Wt: 26.0 Cu.Ft.: 0.6	
Individual Book:						
H: 0.9 W: 8.5 D: 10.9 Wt: 2.6						

209554		WEBER'S NEW AMERICAN BARBECUE DISPLAYER 1 displayer / 5 cookbooks	\$69.67		Master Carton: 1	 0 77924 04194 5
					H: 8.1 W: 9.8 D: 12.0 Wt: 13.3 Cu. Ft.: 0.55	
Individual Book:						

9553		WEBER'S BIG BOOK OF BURGERS Soft cover; 256 pages	\$13.93	\$29.95	Master Carton: 10	 0 77924 03212 7
					H: 4.6 W: 9.7 D: 16.7 Wt: 18.5 Cu.Ft.: 0.4	
Individual Book:						
H: 0.8 W: 9.1 D: 8.1 Wt: 1.8						



209553		WEBER'S BIG BOOK OF BURGERS DISPLAYER 1 displayer / 5 cookbooks	\$69.67		Master Carton: 1	 0 77924 03213 4
					H: 7.6 W: 9.0 D: 10.0 Wt: 9.4 Cu. Ft.: 0.4	
Individual Book:						



FOB



MSRP

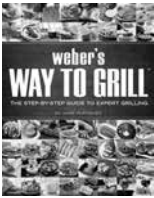

MERCHANDISE: COOKBOOKS



9552		WEBER'S NEW REAL GRILLING Soft cover; 336 pages	\$13.93	\$34.95	Master Carton: 10	
					H: 5.3 W: 11.8 D: 18.5	
					Individual Book:	
					H: 0.9 W: 9.0 D: 11.3 Wt: 3.1	

209552		WEBER'S NEW REAL GRILLING DISPLAYER 1 displayer / 5 cookbooks	\$69.67		Master Carton: 1	
					H: 8.1 W: 9.8 D: 12	
					Individual Book:	
					Wt: 16.8 Cu. Ft.: 0.6	0 77924 02102 2

9551		WEBER'S WAY TO GRILL Soft cover; 320 pages	\$13.93	\$34.95	Master Carton: 10	
					H: 9.6 W: 9.4 D: 11.8	
					Individual Book:	
					H: 0.8 W: 9.0 D: 11.4 Wt: 2.9	

202609		WEBER'S WAY TO GRILL DISPLAYER 1 displayer / 5 cookbooks	\$69.67		Master Carton: 1	
					H: 8.1 W: 9.8 D: 12	
					Individual Book:	
					Wt: 15.5 Cu. Ft.: 0.5	0 77924 01444 4

7605		WEBER'S SMOKE Soft cover; 192 pages	\$13.93	\$29.95	Master Carton: 10	
					H: 7.7 W: 9.8 D: 10.6	
					Individual Book:	
					H: 0.7 W: 9.5 D: 10.3 Wt: 1.7	

207605		WEBER'S SMOKE DISPLAYER 1 displayer / 5 cookbooks	\$69.67		Master Carton: 1	
					H: 4.8 W: 10.7 D: 11.8	
					Individual Book:	
					Wt: 9.5 Cu. Ft.: 0.3	0 77924 01520 5

HOW WE MEASURE

GRILLS: OUT-OF-PACKAGE DIMENSIONS - FULLY ASSEMBLED

HEIGHT
Vertical measurement

WIDTH
Horizontal measurement

DEPTH
Distance from front to back

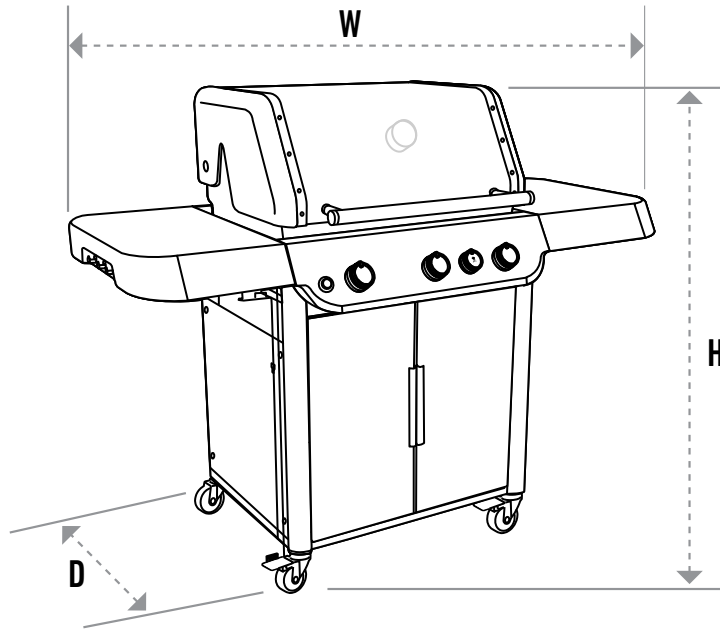

ACCESSORIES: OUT-OF-PACKAGE DIMENSIONS - PRODUCT LAYING FLAT

HEIGHT
Vertical measurement

WIDTH
Horizontal measurement

DEPTH
Distance from front to back

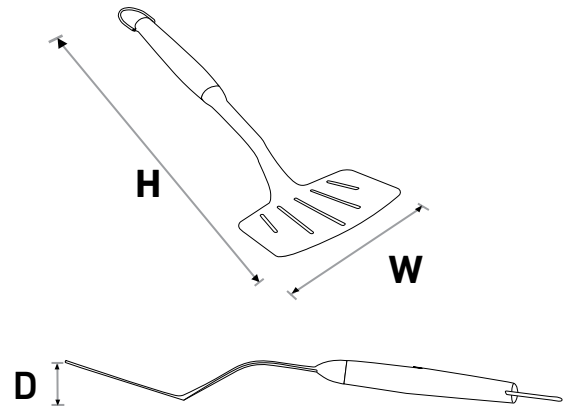
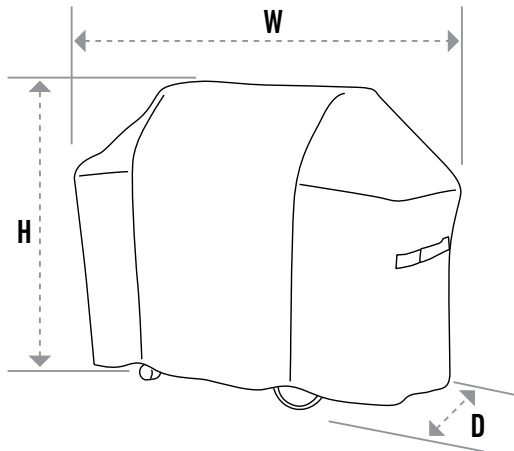

ACCESSORIES: UNIT PACKAGE - UPRIGHT

HEIGHT
Vertical measurement

WIDTH
Horizontal measurement

DEPTH
Distance from front to back

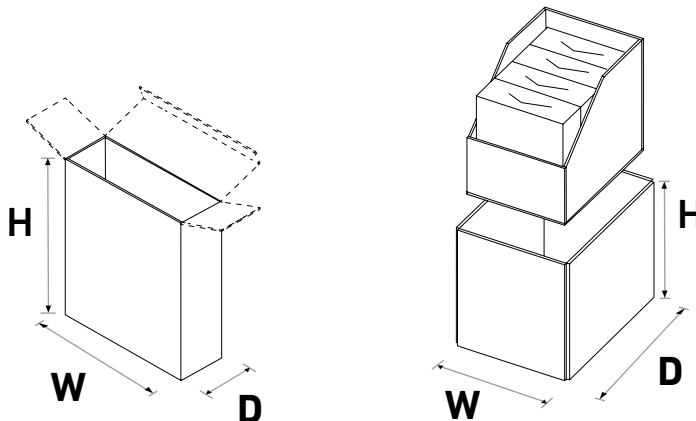

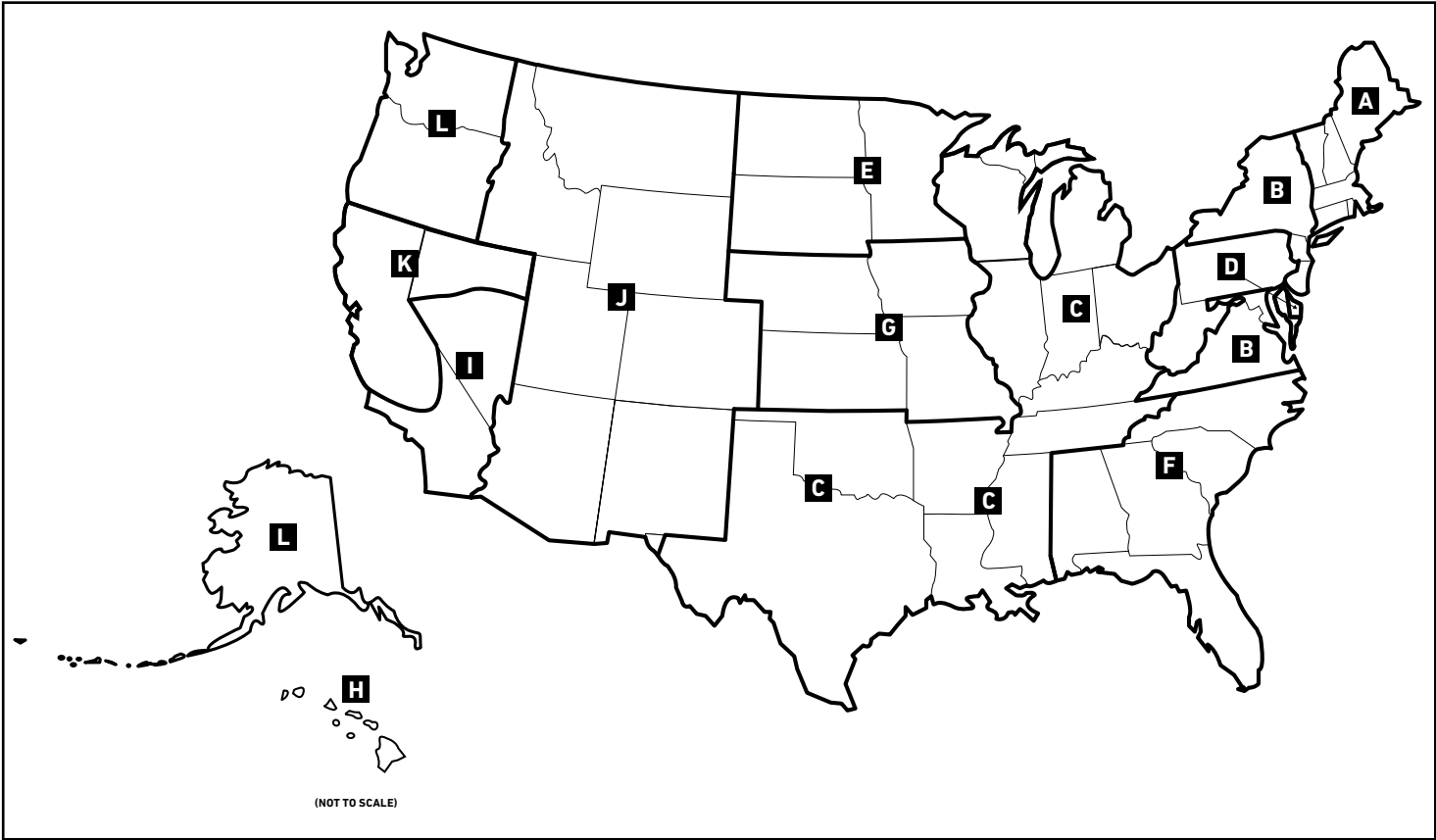

A New England
adm/Lapine
78 Southfield Ave
Stamford, CT 06902
Phone: 855-584-4233
Fax : 203-487-9874
Email: weber@lapineinc.com

B Maryland, Metro New York, Westchester County, and Northern New Jersey, Washington DC, and Virginia
adm/Lapine
78 Southfield Ave
Stamford, CT 06902
Phone: 855-584-4233
Fax : 203-487-9874
Email: weber@lapineinc.com

Upstate New York
adm/Lapine
78 Southfield Ave
Stamford, CT 06902
Phone: 855-584-4233
Fax : 203-487-9874
Email: weber@lapineinc.com

C Arkansas, Illinois, Indiana, Kentucky, Michigan (including Upper Peninsula), Louisiana, Mississippi, Ohio (including Toledo), Oklahoma, Texas, Wisconsin, and Tennessee
Stout, Krug, Krug, Ryan & Associates
1000 W. Touhy Avenue
Park Ridge, IL 60068-3233
phone: 847-823-1575
fax: 847-823-6197

D Pennsylvania, Southern New Jersey, Delaware, and West Virginia
Babcock & Associates, Inc.
1536 E. Lancaster Ave
Suite A.
Paoli, PA 19301
phone: 610-647-4220
fax: 610-889-9738

E Minnesota, North & South Dakota, and Western Wisconsin
The Wright Group
7728 West 78th Street
Bloomington, MN 55435
phone: 952-933-2214 (Minneapolis)
fax: 952-933-0047

REPRESENTATIVES

F Georgia, Alabama, South Carolina, and Florida

adm/Lapine
78 Southfield Ave
Stamford, CT 06902
Phone: 855-584-4233
Fax : 203-487-9874
Email: weber@lapineinc.com

North Carolina

adm/Lapine
78 Southfield Ave
Stamford, CT 06902
Phone: 855-584-4233
Fax : 203-487-9874
Email: weber@lapineinc.com

G Kansas and Missouri

KMY
10500 Barkley, Suite #114
Overland Park, KS 66212
phone: 913-451-0025 (Kansas City)
fax: 913-451-0028

Nebraska and Iowa

KMY
4916 N. 136th Street
Omaha, NE 68164-6177
phone: 402-315-4376 (Omaha)
fax: 402-359-1382

H Hawaii

Pacific Western LLC
94-155 Leowaena Street
Waipahu, Hawaii 96797-2235
phone: 808-671-2817 (Honolulu)
fax: 808-678-0633

I Southern California and Nevada

ABW Marketing, Inc.
16835 Algonquin Street, Suite 376
Huntington Beach, CA 92649
phone: 714-995-4580
fax: 714-995-5372
cell: 714-803-1084

J Colorado, Wyoming, and Montana

Roy J. O'Donnell Co., Inc.
2256 S. Delaware Street
Denver, CO 80223-4100
phone: 602-265-3127
denver@rjoco.com

Utah

Roy J. O'Donnell Co., Inc.
3008 Alice Circle
West Valley, UT 84119
phone: 602-265-3127
phoenix@rjoco.com

Arizona, New Mexico, El Paso, Texas, and Idaho

Roy J. O'Donnell Co., Inc.
2942 North 24th Street, Suite 114
Phoenix, AZ 85016-6400
phone: 602-265-3127
phoenix@rjoco.com

K Northern California and Reno, Nevada

Access Sales Associates, Inc.
1651 Challenge Drive
Concord, CA 94520
phone: 707-864-9534
fax: 707-864-9582

L Washington and Alaska

Koval-Williamson, Inc.
6825 216th St SW, Suite E
Lynnwood, WA 98036
phone: 425-347-4249 (Seattle)
fax: 425-347-2368

Oregon

Koval-Williamson, Inc.
2300 SE Beta Street, Suite A
Milwaukie, OR 97222 (Portland)
phone: 503-653-9650
fax: 503-653-9683

Military

Specialized Marketing
8220 Elmbrook Drive
Dallas, TX 75247-4010
phone: 214-630-8771
fax: 214-689-6171

Special Markets

1415 S. Roselle Road
Palatine, IL 60067
phone: 224-836-8266
fax: 224-836-8977

2290	56	6532	64	6776	48
3201	45	6533	65	6777	48
3250	45	6534	65	6778	49
3254	45	6535	65	6779	49
6275	69	6557	85	6780	49
6276	69	6558	58	6781	49
6277	69	6559	58	6782	49
6278	69	6605	55	6783	49
6279	69	6608	48	6784	50
6320	47	6611	57	6785	50
6414	78	6612	57	6786	50
6415	70	6613	60	6787	57
6416	70	6614	60	6788	57
6435	54	6618	85	6789	57
6469	55	6619	85	7001	62
6470	55	6634	54	7002	62
6471	56	6645	48	7003	62
6481	54	6691	64	7004	61
6482	55	6707	48	7005	63
6483	64	6731	55	7007	59
6488	64	6750	46	7008	63
6489	64	6768	47	7009	62
6498	70	6769	47	7017	63
6501	78	6770	47	7030	71
6506	58	6771	47	7031	63
6525	85	6772	47	7032	63

INDEX

7034	57	7197	71	7507	80
7035	72	7202	45	7508	81
7036	72	7203	45	7509	81
7108	75	7211	46	7510	81
7109	75	7212	46	7513	82
7110	73	7401	86	7515	82
7111	73	7403	60	7524	78
7112	73	7404	58	7528	79
7113	73	7416	59	7534	79
7137	73	7417	59	7536	79
7138	73	7421	53	7539	80
7139	74	7431	83	7561	75
7148	76	7432	83	7576	65
7150	76	7433	83	7598	58
7151	76	7435	83	7599	58
7152	77	7436	83	7605	88
7153	77	7439	82	7620	80
7154	76	7440	82	7621	80
7173	77	7441	83	7627	80
7174	77	7444	84	7628	81
7175	76	7447	60	7629	81
7176	76	7459	69	7635	79
7181	71	7478	84	7636	79
7190	72	7480	59	7639	79
7191	72	7481	59	7641	82
7196	71	7502	80	7642	81

7644	78	7852	52	17138	66
7645	78	7853	52	17139	66
7646	78	7854	52	17140	66
7647	55	7856	52	17142	66
7649	60	7860	52	17143	67
7652	56	8025	68	17148	67
7653	56	8026	68	17149	67
7659	56	8027	68	17150	67
7661	86	8028	68	17302	65
7666	59	8029	68	40020	35
7670	51	8829	54	60020	44
7671	51	8834	53	121020	36
7672	51	8835	54	190001	61
7673	51	8836	53	190002	61
7675	51	8838	53	190003	61
7676	51	8859	53	190004	61
7677	50	8860	53	190005	61
7678	50	9551	88	202609	88
7696	63	9552	88	207138	74
7754	74	9553	87	207139	74
7755	74	9554	87	207605	88
7757	74	9557	87	209552	88
7758	75	9558	86	209554	87
7770	71	10020	35	209557	87
7771	72	17136	66	209557	87
7849	52	17137	66	209558	86

INDEX

291001	33	7470001	32	25510201	4
291101	33	7471001	32	35300001	21
292001	33	9010001	9	35310001	19
292101	33	9013001	9	35320001	19
441001	37	9020001	9	35400001	23
711001	44	9030001	9	35410001	22
721001	44	14401001	38	35480001	22
731001	44	14402001	38	35500001	26
741001	37	14407001	38	35510001	25
1126801	35	14501001	40	35600001	28
1141001	36	14505601	40	35610001	27
1211001	35	14510601	40	35810001	29
5006001	10	14511601	40	35913401	20
5012001	8	14513601	40	36400001	24
5106001	10	14516001	40	36410001	24
6012001	85	15301001	41	36800001	30
7160001	34	15401001	41	37300001	21
7170001	31	15501001	42	37310001	19
7171001	31	15502001	42	37320001	19
7260001	34	15507001	42	37400001	23
7270001	31	16401001	39	37410001	22
7271001	31	18201001	43	37480001	22
7360001	34	18501101	43	37500001	26
7370001	32	22722001	3	37510001	25
7371001	32	23510201	4	37600001	28
7460001	34	23722001	3	37610001	27

37810001	29	53060001	11
37913401	20	54060001	11
38400001	24	55020001	7
38800001	30	57060001	12
43310201	2	57067001	12
44010001	13	91010901	5
45010001	13	91070901	5
46110001	14	91280901	5
46502001	15	91300901	5
46502401	17	91400901	5
46510001	14	92010901	6
46512401	16	92070901	6
46810001	15	92280901	6
46912401	16	92300901	6
47502001	15	92400901	6
47502401	17	384100001	24
47510001	14		
47512401	16		
47912401	16		
49010001	13		
51010001	10		
51040001	10		
51070001	10		
51080001	10		
51190001	10		
52020001	7		

©2022 Weber-Stephen Products LLC. Weber, the kettle silhouette, kettle configuration are registered U.S. Trademarks all of Weber-Stephen Products LLC, 1415 S. Roselle Road, Palatine, Illinois 60067 USA.

The Bluetooth® word mark and logos are registered trademarks owned by the Bluetooth SIG, Inc. and any use of such marks by Weber-Stephen Products LLC is under license. Other trademarks and trade names are those of their respective owners.