

# USER GUIDE & SERVICE MANUAL



5 Class • UHWD524 • 24" Dual Zone Wine Captain®

**Tip:** Click on any section below to jump directly there

## Table of Contents

Intro

Warranty Claims

Warranty

## Safety

Safety and Warning

Disposal And Recycling

## Installation

Environmental Requirements

Electrical

Cutout & Product Dimensions

Side by Side Installation

Anti-Tip Bracket

General Installation

Grille Installation

Door Swing

Door Adjust

Interior Adjustments

## Maintenance

Cleaning

Cleaning Condenser

Extended Non-Use

## Operating Instructions

First Use

Control Operation

Airflow and Product Loading

## Service

Troubleshooting

Product Liability

## WELCOME TO U-LINE

Congratulations on your U-Line purchase. Your product comes from a company with over five decades of premium modular ice making, refrigeration, and wine preservation experience. U-Line continues to be the American leader, delivering versatility and flexibility for multiple applications including residential, light commercial, outdoor and marine use. U-Line's complete product collection includes Wine Captain® Models, Beverage Centers, Clear Ice Machines, Nugget Ice Machines, Crescent Ice Makers, Glass & Solid Door Refrigerators, Drawer Models, Freezers, Combo® Models, and more.

U-Line has captivated those with an appreciation for the finer things with exceptional functionality, style, inspired innovations and attention to even the smallest details. We are known and respected for our unwavering dedication to product design, quality and selection. U-Line is headquartered in Milwaukee, Wisconsin and has shipped product to five continents for over two decades and is proud to have the opportunity to ship to you.

## PRODUCT INFORMATION

Looking for additional information on your product? User Guides, Spec Sheets, CAD Drawings, Compliance Documentation, and Product Warranty information are all available for reference and download at [u-line.com](http://u-line.com).

## PROPERTY DAMAGE / INJURY CONCERNS

In the unlikely event property damage or personal injury is suspected related to a U-Line product, please take the following steps:

1. U-Line Customer Care must be contacted immediately at +1.800.779.2547.
2. Service or repairs performed on the unit without prior written approval from U-Line is not permitted. If the unit has been altered or repaired in the field without prior written approval from U-Line, claims will not be eligible.

## GENERAL INQUIRIES

U-Line Corporation  
8900 N. 55th Street  
Milwaukee, Wisconsin 53223 USA  
Monday - Friday 8:00 am to 4:30 pm CST  
T: +1.414.354.0300  
F: +1.414.354.7905  
Email: [sales@u-line.com](mailto:sales@u-line.com)  
[u-line.com](http://u-line.com)

## SERVICE & PARTS ASSISTANCE

Monday - Friday 8:00 am to 4:30 pm CST  
T: +1.800.779.2547  
F: +1.414.354.5696  
Service Email: [onlineservice@u-line.com](mailto:onlineservice@u-line.com)  
Parts Email: [onlineparts@u-line.com](mailto:onlineparts@u-line.com)

## CONNECT WITH US



Designed, engineered and assembled in WI, USA



## Safety and Warning

### NOTICE

**Please read all instructions before installing, operating, or servicing the appliance.**

Use this appliance for its intended purpose only and follow these general precautions with those listed throughout this guide:

### SAFETY ALERT DEFINITIONS

Throughout this guide are safety items labeled with a Danger, Warning, or Caution based on the risk type:



**Danger means that failure to follow this safety statement will result in severe personal injury or death.**



**Warning means that failure to follow this safety statement could result in serious personal injury or death.**



**Caution means that failure to follow this safety statement may result in minor or moderate personal injury, property, or equipment damage.**



**This unit contains R600a (Isobutane) which is a flammable hydrocarbon. It is safe for regular use. Do not use sharp objects to expedite defrosting. Do not service without consulting the “R600a specifications” section included in the User Guide. Do not damage the refrigerant circuit.**



**Service must be done by factory authorized service personnel. Any parts shall be replaced with like components. Failure to comply could increase the risk of possible ignition due to incorrect parts or improper service.**

### CALIFORNIA PROPOSITION 65

**This product contains chemicals known to the state of California to cause cancer and birth defects or other reproductive harm.**

[www.P65warnings.CA.gov](http://www.P65warnings.CA.gov)



**This equipment is to be installed with adequate backflow protection to comply with applicable federal, state and local codes.**

## Disposal and Recycling

 **DANGER**

**RISK OF CHILD ENTRAPMENT. Before you throw away your old refrigerator or freezer, take off the doors and leave shelves in place so children may not easily climb inside.**

If the unit is being removed from service for disposal, check and obey all federal, state, and local regulations regarding the disposal and recycling of refrigeration appliances, and follow these steps completely:

1. Remove all consumable contents from the unit.
2. Unplug the electrical cord from its socket.
3. Remove the door(s)/drawer(s).

## Environmental Requirements

This model is intended for indoor/interior applications only and is not to be used in installations that are open/exposed to natural elements.

This unit is designed to operate between 50°F (10°C) and 100°F (38°C). Higher ambient temperatures may reduce the unit's ability to reach low temperatures and/or reduce ice production on applicable models.

For best performance, keep the unit out of direct sunlight and away from heat generating equipment.

In climates where high humidity and dew points are present, condensation may appear on outside surfaces. This is considered normal. The condensation will evaporate when the humidity drops.



**Damages caused by ambient temperatures of 40°F (4°C) or below are not covered by the warranty.**

## Electrical



**SHOCK HAZARD – Electrical Grounding Required. Never attempt to repair or perform maintenance on the unit until the electricity has been disconnected.**

**Never remove the round grounding prong from the plug and never use a two-prong grounding adapter.**

**Altering, cutting or removing power cord, removing power plug, or direct wiring can cause serious injury, fire, loss of property and/or life, and will void the warranty.**

**Never use an extension cord to connect power to the unit.**

**Always keep your working area dry.**

### NOTICE

**Electrical installation must observe all state and local codes. This unit requires connection to a grounded (three-prong), polarized receptacle that has been placed by a qualified electrician.**

The unit requires a grounded and polarized 115 VAC, 60 Hz, 15A power supply (normal household current). An individual, properly grounded branch circuit or circuit breaker is recommended. A GFCI (ground fault circuit interrupter) is usually not required for fixed location appliances and is not recommended for your unit because it could be prone to nuisance tripping. However, be sure to consult your local codes.

See CUTOUT & PRODUCT DIMENSIONS for recommended receptacle location.

# Cutout & Product Dimensions

## PREPARE SITE

Your U-Line product has been designed for either free-standing or built-in installation. When built-in, your unit does not require additional air space for top, sides, or rear. However, the front grille must NOT be obstructed, and clearance is required for an electrical connection in the rear.



**Unit can NOT be installed behind a closed cabinet door.**

## CUTOUT DIMENSIONS

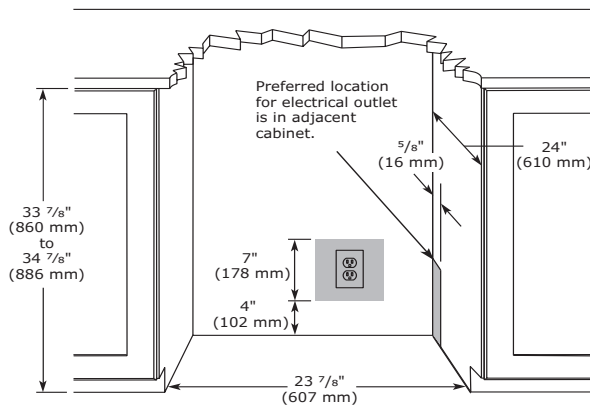

## PRODUCT DIMENSIONS

### REAR

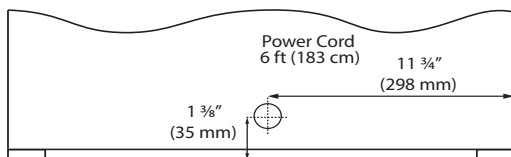

### FRONT

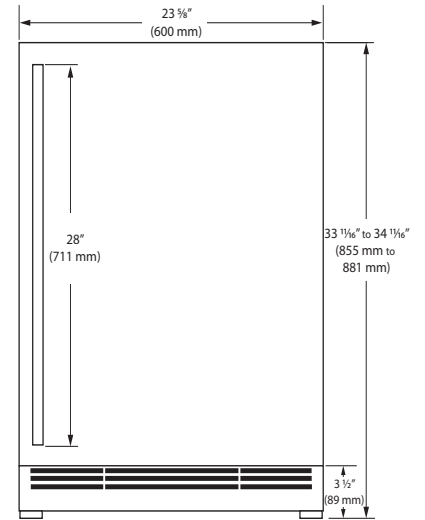

### TOP

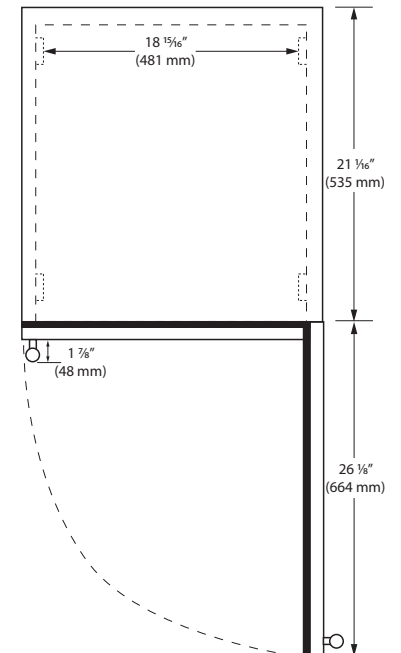

### SIDE

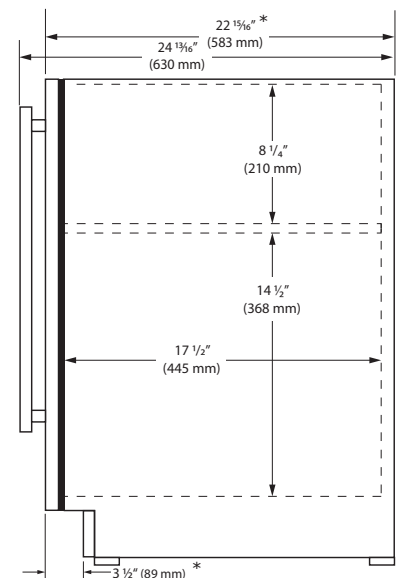

\*Add 1/2" for integrated models with 3/4" panel installed.



## Side-by-Side Installation

### OTHER SITE REQUIREMENTS

#### Side-by-Side Installation

Units must operate from separate, properly grounded electrical receptacles placed according to each unit's electrical specifications requirements.

Cutout width for a side-by-side installation is the total of the widths listed under Cutout Dimensions in each unit's Installation Guide. Each door can be opened individually (one at a time) without interference.



However, to ensure unobstructed door swing (opening both doors at the same time), 1/4" (6.4 mm) of space needs to be maintained between the units.



### Hinge-by-Hinge Installation (Mullion)

When installing two units hinge-by-hinge, 13/16" (22 mm) is required for integrated models. Additional space may be needed for any knobs, pulls or handles installed.



Stainless steel models which include the standard stainless handle will require 4-9/16" (116 mm) to allow both doors to open to 90° at the same time.



## Anti-Tip Bracket

Use one of the methods below to secure the unit

### CABINET/COUNTER ANTI-TIP INSTALLATION

(For built-in applications)

1. Slide unit out so screws on front of unit are easily accessible.
2. Remove the two screws from the front of the unit.

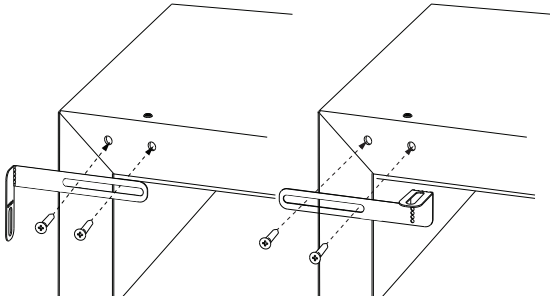

3. Bend bracket along one of the perforations to allow attachment to the desired adjoining surface.
4. Gently push unit into position. Be careful not to entangle the electrical cord or water line, if applicable.
5. Check to be sure the unit is level from front to back and side to side. Make any necessary adjustments. The unit's top surface should be approximately  $\frac{1}{8}$ " (3 mm) below the countertop.
6. Secure bracket to adjoining surface.

### FLOOR MOUNTED ANTI-TIP INSTALLATION

(For free-standing applications)

1. Locate two anti-tip brackets included with the kit.
2. Place the unit into the area where it will be installed. Check the door, sides, and top for a proper fit. Also test to make sure the door opens and closes freely.
3. Remove grille and place a mark on the floor at the front of the unit. Also place a mark on the floor in the center of the unit.
4. Remove the unit. Using a square, extend center line "B" (see chart below). This line serves as the back edge for the anti-tip brackets. From the center line, measure "A" to the left and right. This line is the outer edge of each bracket.

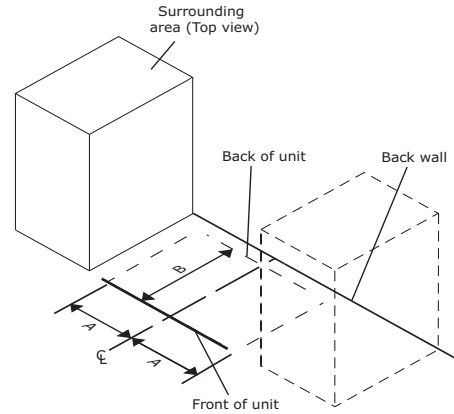

	<b>515</b>	<b>518</b>	<b>524</b>
<b>A</b>	7 $\frac{5}{8}$ "	9"	11 $\frac{15}{16}$ "
<b>B</b>	22"	22"	22"

5. Place the anti-tip brackets on the floor against the line drawn for the outer edge. Mark spots for the screw holes.



6. Use a  $\frac{1}{8}$ " drill to make two starter holes and fasten the anti-tip brackets to the floor using the screws provided.
7. Place the unit back into position, making sure the feet engage the anti-tip brackets properly. Check the alignment of the lines made on the floor in step 3 with the position of the front feet to ensure proper positioning.

## General Installation

### LEVELING INFORMATION

1. Use a level to confirm the unit is level. Level should be placed along top edge and side edge as shown.

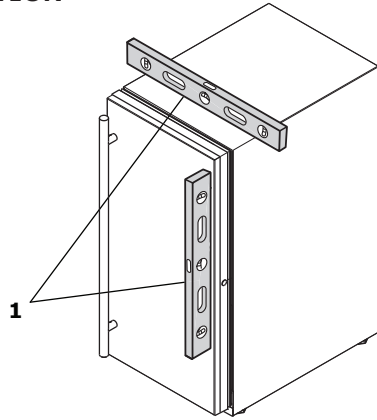

2. If the unit is not level, adjust the legs on the corners of the unit as necessary.

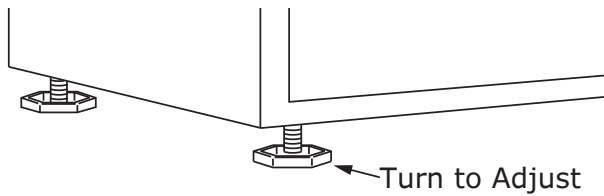

3. Confirm the unit is level after each adjustment and repeat the previous steps as needed.

### INSTALLATION TIP

If the room floor is higher than the floor in the cutout opening, adjust the rear legs to achieve a total unit rear height of  $\frac{1}{8}$ " (3 mm) less than opening's rear height. Shorten the unit height in the front by adjusting the front legs. This allows the unit to be gently tipped into the opening. Readjust the front legs to level the unit after it is correctly positioned in the opening.

### INSTALLATION

1. Plug in the power/electrical cord.
2. Gently push the unit into position. Be careful not to entangle the cord or water and drain lines, if applicable.
3. Re-check the leveling, from front to back and side to side. Make any necessary adjustments. The unit's top surface should be approximately  $\frac{1}{8}$ " (3 mm) below the countertop.
4. Install the anti-tip bracket.
5. Remove interior packing material and wipe out the inside of the unit with a clean, water-dampened cloth.

## Grille Installation

### REMOVING AND INSTALLING GRILLE



**Disconnect electric power to the unit before removing the grille.**

**When using the unit, the grille must be installed.**



**DO NOT touch the condenser fins. The condenser fins are SHARP and can be easily damaged.**

#### Removing the grille

1. Disconnect power to the unit.
2. Loosen the two screws (1).
3. Remove grille (2) from unit.

#### Installing the grille

1. Align cabinet and grille holes and secure, but do not over tighten grille screws (1).
2. Reconnect power to the unit.

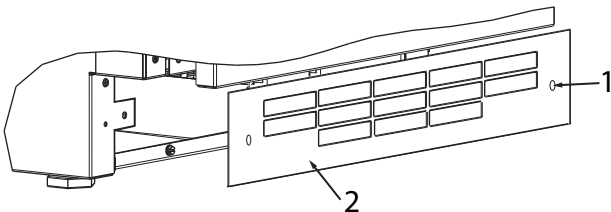

## Door Swing

For Integrated models that are installed adjacent to a wall, 1/2" (13 mm) clearance is recommended from wall on hinge side to allow the door to open 90°. Allow for additional space for any knobs or pulls installed on the integrated panel/frame.

Stainless Steel models that are installed adjacent to a wall require 2-1/4" (57 mm) door clearance on hinge side to allow for door handle.

Units have a zero clearance when installed adjacent to cabinets.

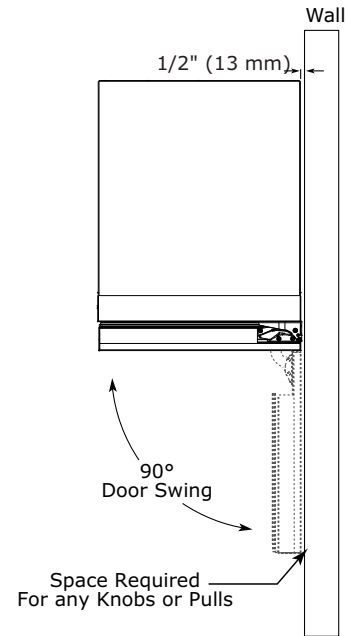

**Integrated**

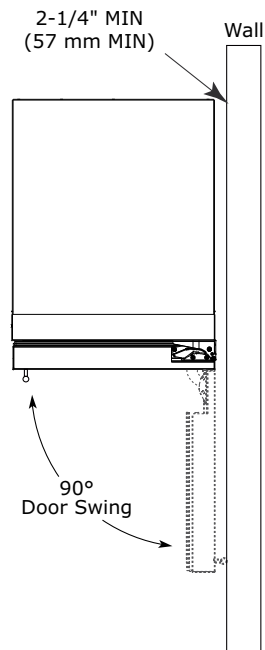

**Stainless**

## Door Adjustments

### DOOR ALIGNMENT AND ADJUSTMENT

Align and adjust the door if it is not level or not sealing properly. If the door is not sealed, the unit may not cool properly, or excessive frost or condensation may form in the interior.

#### NOTICE

**Properly aligned, the door's gasket should be firmly in contact with the cabinet all the way around the door (no gaps). Carefully examine the door's gasket to ensure that it is firmly in contact with the cabinet. Also make sure the door gasket is not pinched on the hinge side of the door.**



**Do not attempt to use the door to raise or pivot your unit. This would put excessive stress on the hinge system.**

#### Alignment and Adjustment Procedure

1. Open door and remove gasket near the hinges.
2. Using a T-25 Torx bit, loosen each pair of Torx head screws both the upper and lower hinge plates.
3. Square and align door as necessary.
4. Tighten Torx head screws on hinge.
5. Reinstall gasket into the channel starting at the corner.

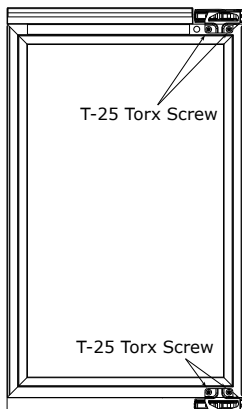

### REVERSING THE DOOR

1. Open door.
2. Using T-25 Torx bit loosen screw #1 and remove screw #2 on top and bottom hinge. Slide and remove the door from the unit.

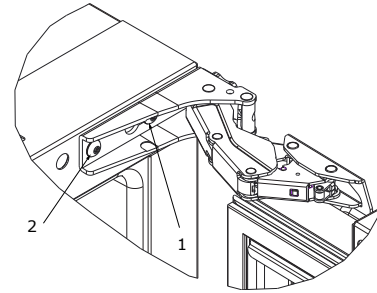

**Note: One hinge includes a metal spacer. Spacer must be used with that hinge when reversing the door.**



3. Remove caps from screw heads on opposite side (2 on top and 2 on bottom). Using #2 Phillips bit, remove the 4 underlying screws. Reinstall the screws and caps on the opposite side.
4. Partially install screw #1 in the outer most holes on top and bottom. Rotate door 180o, align hinge over screw #1 and slide/seat into position. Reinstall screw #2 on top and bottom. Tighten both screws and install hinge cover.

#### Align and adjust the door:

Align and adjust the door (see DOOR ALIGNMENT AND ADJUSTMENT).



## First Use

Initial startup requires no adjustments. When plugged in, the unit will begin operating under the factory default settings. If the unit was turned off during installation, simply press  and the unit will immediately switch on. To turn the unit off, press .

### **NOTICE**







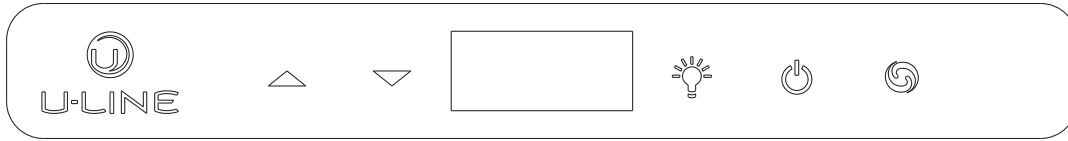



















**Temperature displayed reflects actual temperature inside unit.**

If the temperature displayed is different than selected, the unit is progressing towards the selected temperature. Time to reach set point varies based upon ambient temperature, temperature of product loaded, door openings, etc. U-Line recommends allowing the unit to reach set points before loading.

## Control Operation



### CONTROL FUNCTION GUIDE

FUNCTION	COMMAND	NOTES												
ON/OFF	Press  and release	Unit will immediately turn On or OFF												
Adjust Temperatures	Press  or  and release to adjust the lower zone. Press  to change to upper zone. Press  or  and release to adjust.	Interior light color indicates zone temperature being set; Blue = lower (38° - 65°) White = upper (38° - 65°)  The upper temperature must be ≥ the lower temperature, maximum 20° higher.  Note: Adjusting the temperature in lower zone, may result in the upper zone automatically adjusting. When adjusting upper zone, control will not go beyond the maximum temperature spread.  See table on next page.												
Toggle between °F / °C	Hold  and  for 5 seconds	The display will change units												
Leave interior light on	Press  and release to leave interior light on for 12 hours; press again to deactivate	After 12 hours, factory default is restored; light will turn on when door is open												
Hide Display	Hold  and press 	Display will turn off when door is closed. Unit will continue to operate. Repeat command to turn on display												
Adjust light color	While holding  press and release  to scroll through lighting options	<table border="1"> <thead> <tr> <th>Option</th> <th>Open Door</th> <th>Closed Door</th> </tr> </thead> <tbody> <tr> <td></td> <td>White</td> <td>White</td> </tr> <tr> <td></td> <td>Blue</td> <td>Blue</td> </tr> <tr> <td></td> <td>White</td> <td>Blue</td> </tr> </tbody> </table> Light will be set at full intensity when door is open, and 50% intensity when door is closed.	Option	Open Door	Closed Door		White	White		Blue	Blue		White	Blue
Option	Open Door	Closed Door												
	White	White												
	Blue	Blue												
	White	Blue												
Enable Sabbath Mode	Press  and hold for 5 seconds and release	The °F / °C symbol will flash briefly after 5 seconds. Interior light and display will go dark and remain so until user resets mode - unit continues to operate												
Disable Sabbath Mode	Press  and release	Display and interior light return to normal operation												
Showroom Mode	Hold  and  for 5 seconds	The °F / °C symbol will flash. Display will be lit and interior light will function. Unit will not cool. Repeat command to return to normal operation												

This unit is Star-K certified. See [www.star-k.org](http://www.star-k.org) for more details.

### DOOR ALERT NOTIFICATION

When the door is left open for more than 5 minutes:

- A tone will sound for several seconds every minute
-  will appear in display
- Closed door to silence alert and reset

**Dual Zone Temperature Table**

**Note: The temperature of the upper zone cannot be less than the temperature of the lower zone.**

Wine Dual Zone		
Lower Zone: 38° - 65°	Upper Zone: 38° - 65°	
	Minimum	Maximum
38	38	58
39	39	59
40	40	60
41	41	61
42	42	62
43	43	63
44	44	64
45	45	65
46	46	65
47	47	65
48	48	65
49	49	65
50	50	65
51	51	65
52	52	65
53	53	65
54	54	65
55	55	65
56	56	65
57	57	65
58	58	65
59	59	65
60	60	65
61	61	65
62	62	65
63	63	65
64	64	65
65	65	65

## Airflow & Product Loading

### AIRFLOW

#### External

- Do not block the front grille - no additional clearance around sides, top or rear of unit is needed for ventilation
- Do not install behind a closed door

#### Internal

- When loading, leave space between internal fans, vents, and side walls to allow air to circulate freely

### PRODUCT LOADING

Bottles and cans come in all shapes and sizes. When determining capacities U-Line uses the following sizes. Combinations of red and white bottles are used in Wine Captain® Models and Beverage Centers.

### NOTICE

**Restricting airflow may result in poor product performance, product failure, and uneven internal temperatures and may freeze contents.**

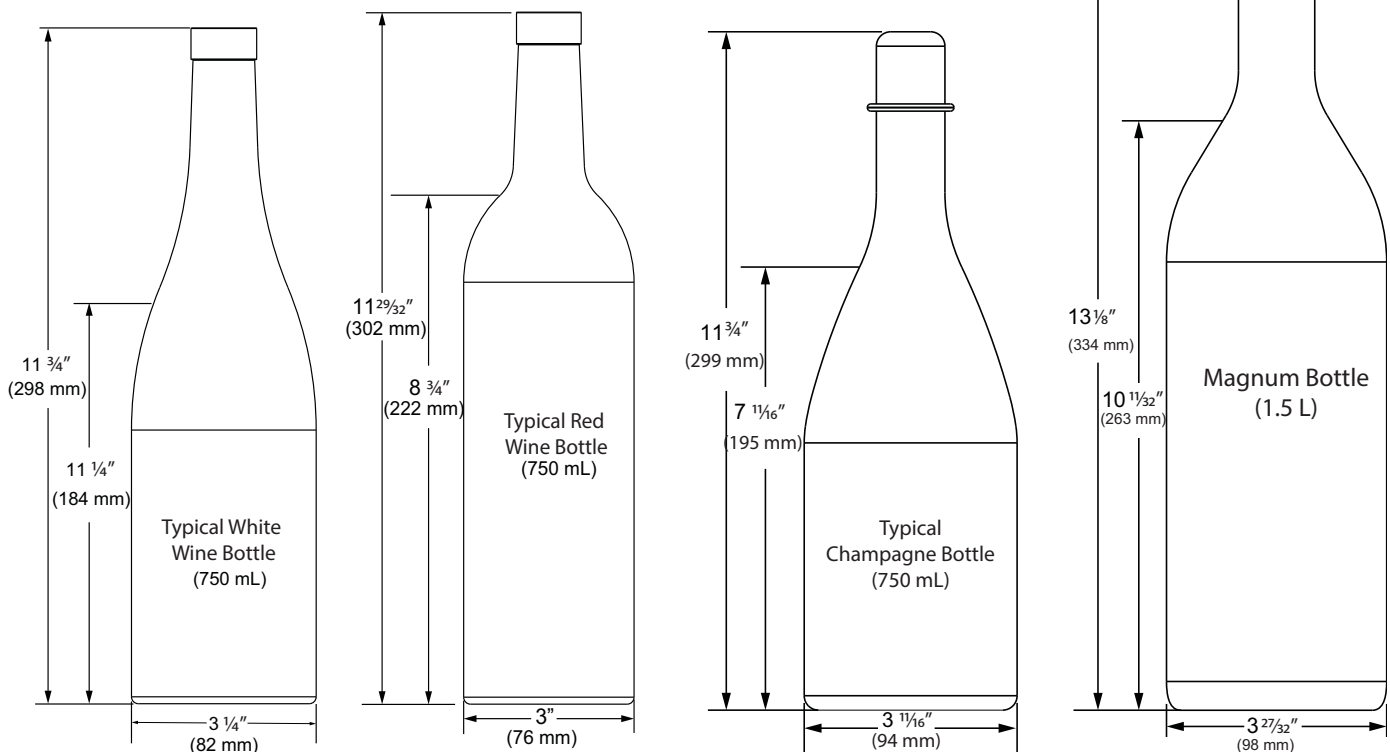
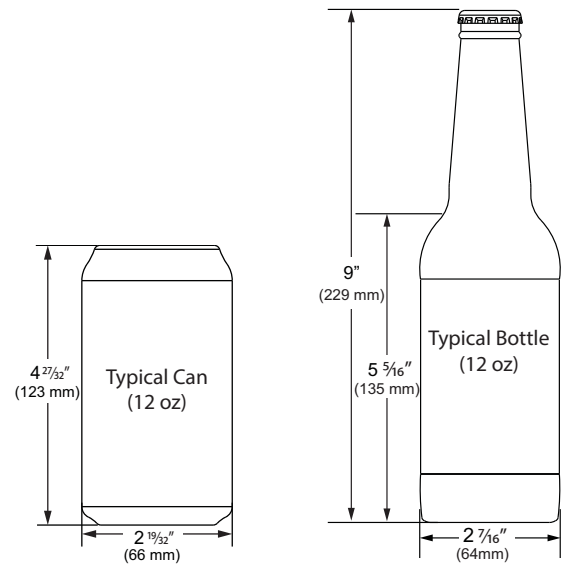

## Interior Adjustments

Dual Zone Wine Captain® models feature side mounted rack supports with 17 adjustment positions.

Dual Zone models ship with 6 racks. Remove and reposition racks as desired to accommodate a variety of bottle sizes and shapes.

### WINE RACK & SHELF ADJUSTMENT

#### Removal

1. Fully extend empty rack

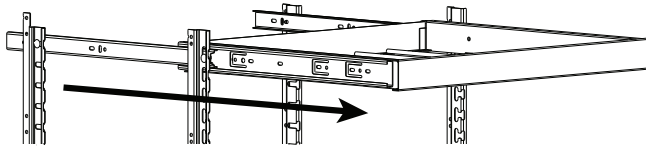

2. Firmly grasp both sides of rack and lift front end of rack slightly (about 1/4") to center the pin in the slot.

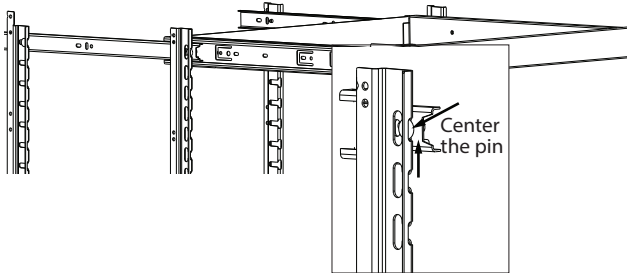

3. Pull rack towards you until all pins are clear of the slots. If only repositioning the rack, do not remove completely - go to "Rack Installation" Step 2.
4. Slightly tilt one side. Gently pull rack towards you to remove rack from unit.

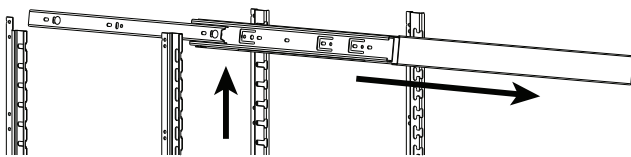

**Note:** Take care when removing rack to avoid scratching interior of unit.

5. Once removed, retract the slides.

**Note:** The slides on the rack have a thin coating which is used to block moisture and provide lubrication. Use care when handling.

#### Installation

1. Insert empty rack into unit with one side tilted slightly downward until back pin is between front and rear rail supports.

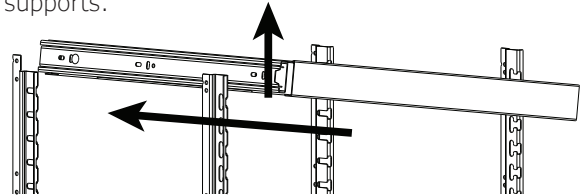

2. Tilt rack back to horizontal and line up 2 back pins with back slots.

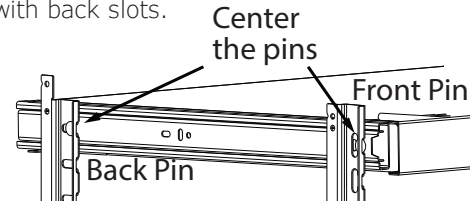

3. Line up 2 back pins with 2 back slots and 2 front pins with 2 front slots.
4. Continue inserting rack until all four pins are fully inserted. Front of rack will set down slightly into the front slots and be locked into position.

#### WINE RACK BOTTLE POSITION

Specially designed horizontal wine racks properly position the bottles so the wine remains in contact with the cork, which ensures the cork does not become dry.

Racks are designed to accommodate typical 750ml wine bottles as follows:

#### UHWD524 24" Wine Captain Models



7 Bottles

## Cleaning

### Stainless Models

Stainless door panels and handles can discolor when exposed to chlorine gas, pool chemicals, saltwater or cleaners with bleach.

Keep your stainless unit looking new by cleaning with a good quality all-in-one stainless steel cleaner and polish monthly. For best results use Claire® Stainless Steel Polish and Cleaner. Comparable products are acceptable. Frequent cleaning will remove surface contamination that could lead to rust. Some installations may require cleaning weekly.

**Do not clean with steel wool pads.**

**Do not use stainless steel cleaners or polishes on any glass surfaces.**

Clean any glass surfaces with a non-chlorine glass cleaner.

**Do not use cleaners not specifically intended for stainless steel on stainless steel surfaces (this includes glass, tile and counter cleaners).**

If any surface discoloring or rusting appears, clean it quickly with Bon-Ami® or Barkeepers Friend Cleanser® and a nonabrasive cloth. Always clean with the grain. Always finish with Claire® Stainless Steel Polish and Cleaner or comparable product to prevent further problems.

**Using abrasive pads such as Scotchbrite™ will cause the graining in the stainless steel to become blurred.**

**Rust not cleaned up promptly can penetrate the surface of the stainless steel and complete removal of the rust may not be possible.**

### Integrated Models

To clean integrated panels, use household cleaner per the cabinet manufacturer's recommendation.

### INTERIOR CLEANING

Disconnect power to the unit.

Clean the interior and all removed components using a mild nonabrasive detergent and warm water solution applied with a soft sponge or non-abrasive cloth.

Rinse the interior using a soft sponge and clean water.

**Do not use any solvent-based or abrasive cleaners.** These types of cleaners may transfer taste to the interior products and damage or discolor the lining.

### DEFROSTING

Under normal conditions this unit does not require manual defrosting. Minor frost on the rear wall or visible through the evaporator plate vents is normal and will melt during each off cycle.

If there is excessive build-up of 1/4" (6 mm) or more, manually defrost the unit.

Ensure the door is closing and sealing properly.

High ambient temperature and excessive humidity can also produce frost.



**DO NOT use an ice pick or other sharp instrument to help speed up defrosting. These instruments can puncture the inner lining or damage the cooling unit. DO NOT use any type of heater to defrost. Using a heater to speed up defrosting can cause personal injury and damage to the inner lining.**



## **NOTICE**

**The drain pan was not designed to capture the water created when manually defrosting. To prevent water from overflowing the drain pan and possibly damaging water sensitive flooring, the unit must be removed from cabinetry.**

### **To defrost:**

1. Disconnect power to the unit.
2. Remove all products from the interior.
3. Prop the door in an open position (2 in. [50 mm] minimum).
4. Allow the frost to melt naturally.
5. After the frost melts completely clean the interior and all removed components. (See INTERIOR CLEANING).
6. When the interior is dry, reconnect power and turn unit on.

## Cleaning Condenser

### **INTERVAL - EVERY SIX MONTHS**

To maintain operational efficiency, keep the front grille free of dust and lint, and clean the condenser when necessary. Depending on environmental conditions, more or less frequent cleaning may be necessary.

 **WARNING**

**Disconnect electric power to the unit before cleaning the condenser.**

### **NOTICE**

**DO NOT use any type of cleaner on the condenser unit. Condenser may be cleaned using a vacuum, soft brush, or compressed air.**

1. Remove the grille. See GRILLE INSTALLATION).
2. Clean the condenser coil using a soft brush or vacuum cleaner.
3. Install the grille.

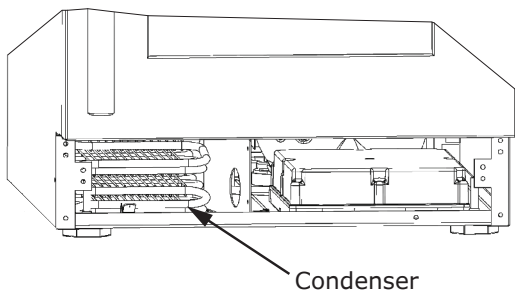

## Extended Non-Use

### **VACATION/HOLIDAY, PROLONGED SHUTDOWN**

The following steps are recommended for periods of extended non-use:

1. Remove all consumable content from the unit.
2. Disconnect the power cord from its outlet/socket and leave it disconnected until the unit is returned to service.
3. If ice is on the evaporator, allow ice to thaw naturally.
4. Clean and dry the interior of the unit. Ensure all water has been removed from the unit.
5. The door must remain open to prevent formation of mold and mildew. Open door a minimum of 2" (50 mm) to provide the necessary ventilation.

### **WINTERIZATION**

If the unit will be exposed to temperatures of 40°F (5°C) or less, the steps above must be followed.

**For questions regarding winterization, please call U-Line at 800.779.2547.**



**Damage caused by freezing temperatures is not covered by the warranty.**

## Troubleshooting

### BEFORE CALLING FOR SERVICE

If you think your U-Line product is malfunctioning, read the CONTROL OPERATION section to clearly understand the function of the control.

If the problem persists, read the NORMAL OPERATING SOUNDS and TROUBLESHOOTING GUIDE sections below to help you quickly identify common problems and possible causes and remedies. Most often, this will resolve the problem without the need to call for service.

### IF SERVICE IS REQUIRED

If you do not understand a troubleshooting remedy, or your product needs service, contact U-Line Corporation directly at +1.800.779.2547.

When you call, you will need your product Model and Serial Numbers. This information appears on the Model and Serial number plate located on the upper right or rear wall of the interior of your product.

### NORMAL OPERATING SOUNDS

All models incorporate rigid foam insulated cabinets to provide high thermal efficiency and maximum sound reduction for its internal working components. Despite this technology, your model may make sounds that are unfamiliar.

Normal operating sounds may be more noticeable because of the unit's environment. Hard surfaces such as cabinets, wood, vinyl or tiled floors and paneled walls have a tendency to reflect normal appliance operating noises.

Listed below are common refrigeration components with a brief description of the normal operating sounds they make. NOTE: Your product may not contain all the components listed.

- Compressor: The compressor makes a hum or pulsing sound that may be heard when it operates.

- Evaporator: Refrigerant flowing through an evaporator may sound like boiling liquid.
- Condenser Fan: Air moving through a condenser may be heard.
- Automatic Defrost Drain Pan: Water may be heard dripping or running into the drain pan when the unit is in the defrost cycle.

### TROUBLESHOOTING GUIDE



**ELECTROCUTION HAZARD. Never attempt to repair or perform maintenance on the unit before disconnecting the main electrical power.**

Troubleshooting - What to check when problems occur:

Problem	Possible Cause and Remedy
Interior Light Does Not Illuminate	If the unit is cooling, it may be in Sabbath mode.
Light Remains on When Door Is Closed.	Turn off light switch if equipped. Adjust light actuator bracket on bottom of door.
Unit Develops Frost on Internal Surfaces.	Ensure the door is closing and sealing properly.
Unit Develops Condensation on External Surfaces.	The unit is exposed to excessive humidity. Moisture will dissipate as humidity levels decrease.
Product is Not Cold Enough	Air temperature does not indicate product temperature. See CHECKING PRODUCT TEMPERATURE below. Adjust the temperature to a cooler set point. Ensure unit is not located in excessive ambient temperatures or in direct sunlight. Ensure the door is closing and sealing properly. Ensure the interior light has not remained on too long. Ensure nothing is blocking the front grille, found at the bottom of the unit. Ensure the condenser coil is clean and free of any dirt or lint build-up.

## CHECKING PRODUCT TEMPERATURE

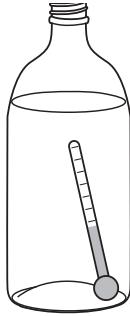

### To check the actual product temperature in the unit:

1. Partially fill a plastic (nonbreakable) bottle with water.
2. Insert an accurate thermometer.
3. Tighten the bottle cap securely.
4. Place the bottle in the desired area for 24 hours.
5. Avoid opening the unit during the testing period.
6. After 24 hours, check the temperature of the water.  
If required, adjust the temperature control in a small increment (see CONTROL OPERATION).

### Causes which affect the internal temperatures of the cabinet include:

- Temperature setting.
- Ambient temperature where installed.
- Installation in direct sunlight or near a heat source.
- The number of door openings and the time the door is open.
- The time the internal light is illuminated. (This mainly affects product on the top rack or shelf.)
- Obstruction of front grille or condenser.

## Product Liability

Field service technicians are authorized to make an initial assessment in the event of reported damages. If there are any questions about the process involved, the technician should call U-Line for further explanation.

While inspecting for defects or installation issues, photos should be taken to document any damages or issues found.

During the assessment, if the service technician is able to find the source of the damage and it can be resolved by replacement of a part, the servicer is authorized to replace the part in question. The part that caused the damage must be returned to U-Line in its entirety. The part must be clearly labeled with the serial number of the unit it was removed from, the date, and the servicer who removed the part.

If the service technician determines the damage is the result of installation issues (water connection/drain, etc.), the consumer would be notified and the issues shall be resolved at the direction of the consumer.

If damage is evident and the service technician is unable to find the source, U-Line must be contacted at 1.800.799.2547 for further direction.

8900 N. 55th Street • Milwaukee, WI 53223  
T: +1.414.354.0300 • F: +1.414.354.5696  
Website: [www.u-line.com](http://www.u-line.com)

**Right product. Right place.  
Right temperature Since 1962.**



## Warranty Claims

The following information defines the parameters for filing a warranty claim:

- Valid serial number needed
- Valid model number needed
- Claims must be submitted online at [www.U-LineService.com](http://www.U-LineService.com)
- 60 day submittal deadline from date of completed service
- Only one repair or unit per warranty claim
- Part order numbers will be required when submitting for warranty labor

Units must be registered prior to warranty submittal. Customers may register at [www.U-Line.com](http://www.U-Line.com). A proof of purchase is required. We also accept the following information to update warranty:

- New construction occupancy documents
- Closing paperwork
- Final billing - Remodel

Warranty parts will be shipped at no charge after U-Line confirms warranty status. Please provide the model, serial number, part number and part description. Some parts will require color or voltage information.

17 14862 05 0527  
|           |           |           |  
Year      Factory    Month    Factory  
          use Only                    use Only

# U-Line Corporation (U-Line) Limited Warranty

## One Year Limited Warranty

For one year from the date of original purchase, this warranty covers all parts and labor to repair or replace any part of the product that proves to be defective in materials or workmanship. For products installed and used for normal residential use, material cosmetic defects are included in this warranty, with coverage limited to 60 days from the date of original purchase. All service provided by U-Line under the above warranty must be performed by a U-Line factory authorized servicer, unless otherwise specified by U-Line. Service provided during normal business hours.

## Two Year Limited Warranty (5 Class Product)

For two years from the date of original purchase, this warranty covers all parts and labor to repair or replace any part of the product that proves to be defective in materials or workmanship. For products installed and used for normal residential use, material cosmetic defects are included in this warranty, with coverage limited to 60 days from the date of original purchase. All service provided by U-Line under the above warranty must be performed by a U-Line factory authorized servicer, unless otherwise specified by U-Line. Service provided during normal business hours.

## Available Second & Third Year Limited Warranty

In addition to the standard one and two year warranties outlined above, U-Line offers a one year extension of the warranties from the date of purchase, free of charge. To take advantage of this extension, you must register your product with U-Line within 60 days from the date of purchase at [u-line.com](http://u-line.com) and provide proof of purchase.

## Five Year Sealed System Limited Warranty

For five years from the date of original purchase, U-Line will repair or replace the following parts, labor not included, that prove to be defective in materials or workmanship: compressor, condenser, evaporator, drier, and all connecting tubing. All service provided by U-Line under the above warranty must be performed by a U-Line factory authorized servicer, unless otherwise specified by U-Line. Service provided during normal business hours.

## Terms

These warranties apply only to products installed in any one of the fifty states of the United States, the District of Columbia, or the ten provinces of Canada. The warranties do not cover any parts or labor to correct any defect caused by negligence, accident or improper use, maintenance, installation, service, repair, acts of God, fire, flood or other natural disasters. The product must be installed, operated, and maintained in accordance with your product's User Guide.

The remedies described above for each warranty are the only ones that U-Line will provide, either under these warranties or under any warranty arising by operation of law. U-Line will not be responsible for any consequential or incidental damages arising from the breach of these warranties or any other warranty, whether express, implied, or statutory. Some states do not allow the exclusion or limitation of incidental or consequential damages, so the above limitation or exclusion may not apply to you. These warranties give you specific legal rights, and you may also have other rights which vary from state to state.

Any warranty that may be implied in connection with your purchase or use of the product, including any warranty of *merchantability* or any warranty *fit for a particular purpose* is limited to the duration of these warranties, and only extends to five years in duration for the parts described in the section related to the five year limited warranty above. Some states do not allow limitations on how long an implied warranty lasts, so the above limitations may not apply to you.

- The warranties only apply to the original purchaser and are non-transferable.
- The second, third, and five year warranties cover products installed and used for normal residential or designated marine use only.
- The warranties apply to units operated outside only if designed for outdoor use by model and serial number.
- U-Line Commercial products are covered by the one year and 5 year limited warranties and are not eligible for the second and third year limited warranties.
- Replacement water filters, light bulbs, and other consumable parts are not covered by these warranties.
- The start of U-Line's obligation is limited to four years after the shipment date from U-Line.
- In-home instruction on how to use your product is not covered by these warranties.
- Food, beverage, and medicine loss are not covered by these warranties.
- If the product is located in an area where U-Line factory authorized service is not available, you may be responsible for a trip charge or you may be required to bring the product to a U-Line factory authorized service location at your own cost and expense.
- Units purchased after use as floor displays, and/or certified reconditioned units, are covered by the limited one year warranty only and no coverage is provided for cosmetic defects.
- Signal issues related to Wi-Fi connectivity are not covered by these warranties.

For parts and service assistance, or to find U-Line factory authorized service near you, contact U-Line:  
8900 N. 55<sup>th</sup> Street, Milwaukee, WI 53223 • [u-line.com](http://u-line.com) • [onlineservice@u-line.com](mailto:onlineservice@u-line.com) • +1.800.779.2547