

URWC324 - 24" WINE REFRIGERATOR

THE HOME COLLECTION

U-LINE



DESIGN

Black interiors with stainless steel accents.

Classic bar door pull on stainless steel model.

Concealed, zero-clearance **articulating door hinge**.

Panel-ready integrated doors, customizable with your panel and hardware, or **choose from our accessory options**.

FEATURES

Built for both **indoor & outdoor use**, with condensation mitigation system.

Carbon filter for enhanced air quality and odor reduction.

Center cabinet vertical lighting: Complete illumination for full visibility throughout the entire interior.

Door alarm activates when the door is left open.

Effortless entry door: Minimizes the physical effort needed, enhancing ease of use for all family members.

Electronic touch control enables precise temperature selection from **34°F to 70°F**.

Evenly distributed forced-air refrigeration system delivers rapid cool down and temperature stability.

Field reversible door is shipped right-hand hinged.

Four leveling legs adjustable up to 1 inch.

Low-E coated, argon gas filled, double thermopane glass door provides protection from harmful UV light.

Low-profile variable speed compressor ensures efficient and powerful cooling with a max output of 1,850 BTU/h.

Sabbath Mode disables interior lights, alarms, and digital displays while maintaining consistent cooling performance.

Six-color multi-point LED lighting in adjustable white: bright white, warm white, cool white, and light blue, deep blue, and teal.

STORAGE

5.1 cu. ft. capacity stores up to **42 wine bottles**.

Cantilever adjustment points for complete interior adaptability.

Six full-extension metal wine racks.

CAPACITY

Volume	5.1 cu. ft.
Wine Bottles (750 mL)	42

DIMENSIONS

Product Depth	22 11/16" (57.6 cm)
Product Height (Min.)	34 1/8" (86.7 cm)
Product Width	23 1/2" (59.7 cm)
Product Weight	120 lbs
Shipping Depth	31" (78.7 cm)
Shipping Height	37" (94 cm)
Shipping Width	28" (71.1 cm)
Shipping Weight	140 lbs

CUSTOM PANEL DIMENSIONS

Panel Height	30" (76.2 cm)
Panel Thickness	3/4" (1.9 cm)
Panel Width	23 1/2" (59.5 cm)
Panel Weight (Max.)	20 lbs
Panel Type	2 3/4" (7 cm) frame or solid panel

SUSTAINABILITY

Refrigerant Type	R600a
GWP (Global Warming Potential)	3 (very low)
ENERGY STAR	Yes

TECHNICAL DETAILS

Cord Length	6 ft.
Electrical Requirements	115V / 60 Hz / 15A

WARRANTY

2 year parts & labor warranty / 6 year sealed system parts warranty (see complete warranty for details).



URWC324 - 24" WINE REFRIGERATOR

THE HOME COLLECTION

U-LINE

INSTALLATION

No additional clearance is needed for ventilation.

Do not obstruct front grille air flow.

Requires 3/4" custom panel and handle (not supplied by U-Line).

PRODUCT DIMENSIONS

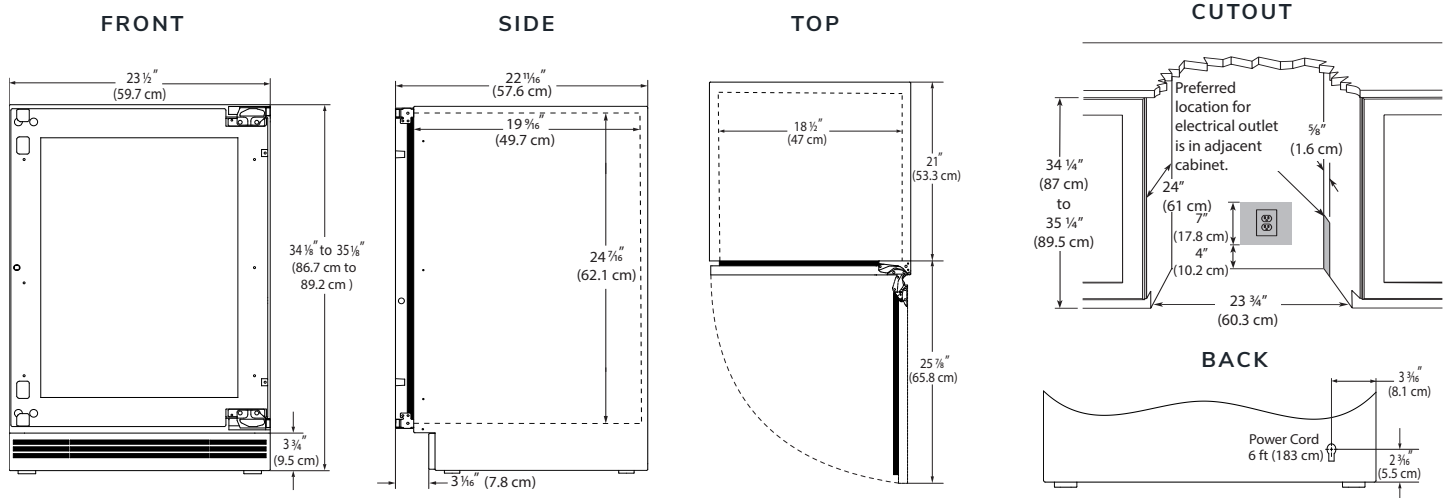

MODELS



URWC324-IG01A
Integrated Frame Glass



URWC324-IS01A
Integrated Solid



URWC324-SG01A
Stainless Steel Frame Glass

ACCESSORIES



ULASBPGLASS24 (Frame)
ULASBPSOLID24 (Solid)
 Stainless Steel Door Wrap
 with Classic Bar Pull