

THOR
K I T C H E N[®]

INSTALLATION INSTRUCTIONS

**24 INCH FREESTANDING
70.4 INCH HEIGHT DUAL
ZONE WINE COOLER
TWC2470D**



TABLE OF CONTENTS

- WARNING.....4
- IMPORTANT SAFETY INSTRUCTIONS.....5
- INSTALLATION INSTRUCTIONS.....6
- OPERATING THE APPLIANCE.....7
- BEVERAGE OR WINE CHART9
- RECOMMENDED DRINKING TEMPERATURE.....12
- CARE AND MAINTENANCE.....13
- WARRANTY.....16

WARNING

- To prevent damaging the door gasket, make sure to have the door all the way opened when pulling shelves out of the rail compartment.
- The appliance must be positioned so that the plug is accessible. Release the electric cord. Move your cabinet to its final location. Do not move your Cabinet while loaded with wine. You might distort the body. The wine cellar should be installed in a suitable place in order to avoid Touching the compressor with the hand. Children should be supervised to ensure that they do not play with the appliance.
- If the supply cord is damaged, it must be replaced by manufacturer of its Service agent or a similarly qualified person in order to avoid a hazard.

This appliance can be used by children aged from 8 years and above and persons with reduced physical, sensory or mental capabilities or lack of experience and knowledge if they have been given supervision or not play with the appliance. Cleaning and user maintenance shall not be made by children without supervision.

Children aged from 3 to 8 years aren't allowed to load and unload wine cooler .

To avoid contamination of wine, please respect the following instructions:

- Opening the door for long periods can cause a significant increase of the temperature in the compartments of the appliance.
- Clean regularly surfaces that can come in contact with bottles and accessible drainage systems.
- Clean water tanks if they have not been used for 48 h; flush the water system connected to a water supply if water has not been drawn for 5 days.
- If the refrigerating appliance is left empty for long periods, switch off, defrost, clean, dry, and leave the door open to prevent mould developing within the appliance.
- **WARNING:** Keep ventilation openings, in the appliance enclosure or in the built-in structure, clear of obstruction.
- **WARNING:** Do not use mechanical devices or other means to accelerate the defrosting process, other than those recommended by the manufacturer.
- **WARNING:** Do not damage the refrigerant circuit.
- **WARNING:** Do not use electrical appliances inside the food storage compartments of the appliance, unless they are of the type recommended by the manufacturer.
- Do not store explosive substances such as aerosol cans with a flammable propellant in this appliance.
- **WARNING:** This refrigerating appliance is not suitable for freezing foodstuffs. This appliance is intended to be used in household and similar applications such as
 - staff kitchen areas in shops, offices and other working environments;
 - farm houses and by clients in hotels, motels and other residential type environments;
 - bed and breakfast type environments;
 - catering and similar non-retail applications.
- **WARNING:** To avoid a hazard due to instability of the appliance, it must be fixed in accordance with the instructions.

PLEASE DON'T TRY TO PLUG INTO OR EXTENSION THE CABLE IN ANY CASE.

IMPORTANT SAFETY INSTRUCTIONS

⚡WARNING⚡

To reduce the risk of fire, electrical shock, or injury when using your appliance, follow these basic precautions:

- Read all instructions before using the wine cooler .
- **DANGER or WARNING:** Risk of child entrapment.
Child entrapment and suffocation are not problems of the past. Junked or abandoned appliances are still dangerous . . . even if they will “just sit in the garage a few days”.
- **Before you throw away your old wine cooler :** Take off the door. Leave the shelves in place so that children may not easily climb inside.
- Never allow children to operate, play with, or crawl inside the appliance.
- Never clean appliance parts with flammable fluids. The fumes can create a fire hazard or explosion.
- Do not store or use gasoline or any other flammable vapors and liquids in the vicinity of this or any other appliance. The fumes can create a fire hazard or explosion.
- **If the refrigerant of these appliances are R600a , Flammable and explosive articles should not be put in or near the cabinet, to avoid the fire or explode caused.**



CYCLOPENTANE

DANGER — Risk of fire or explosion.
Flammable refrigerant used. To be repaired only by trained service personnel. Use only manufacturer-authorized service parts. Any repair equipment used must be designed for flammable refrigerants. Follow all manufacturer repair instructions. Do not puncture refrigerant tubing.

CAUTION — Risk of fire or explosion.
Dispose of refrigerator properly in accordance with the applicable federal or local regulations. Flammable refrigerant used.

CAUTION — Risk of fire or explosion due to puncture of refrigerant tubing; follow handling instructions carefully. Flammable refrigerant used.

DANGER - Risque d'incendie ou d'explosion.
Frigorigène inflammable utilisé. La réparation sera faite seulement par un personnel qualifié. Utiliser seulement des pièces de rechange autorisées par le fabricant. Tout équipement de réparation utilisé doit être conçu pour les frigorigènes inflammables. Suivre toutes les instructions de réparation du fabricant. Ne pas perforer la conduite de frigorigène.

ATTENTION - Risque d'incendie ou d'explosion. Éliminer convenablement conformément à la réglementation fédérale ou locale. Frigorigène inflammable utilisé.

ATTENTION - Risque d'incendie ou d'explosion dû à la perforation de la conduite de frigorigène. Suivre avec soin les instructions de manipulation. Frigorigène inflammable utilisé.

Save these instructions-

INSTALLATION INSTRUCTIONS

➤ **Before Using Your Wine Cooler**

- Remove the exterior and interior packing.
- Before connecting the wine cooler to the power source, let it stand upright for approximately 2 hours. This will reduce the possibility of a malfunction in the cooling system from handling during transportation.
- Clean the interior surface with lukewarm water using a soft cloth.
- This appliance is intended to be used in household and similar applications such as
 - staff kitchen areas in shops, offices and other working environments;
 - farm houses and by clients in hotels, motels and other residential type environments;
 - bed and breakfast type environments;
 - catering and similar non-retail applications.
- When disposing your appliance, please choose an authorized disposal site.

➤ **Installation of Your Wine Cooler**

- This appliance is designed to be for free standing installation or built-in (fully recessed) (Refer to sticker location the back of this appliance).

This appliances are intended to be used exclusively for the storage of wine .

- Place your wine cooler on a floor that is strong enough to support it when it is fully loaded. To level your wine cooler , adjust the front leveling leg at the bottom of the wine cooler .
- This appliance is using flammability refrigerant. So never damage the cooling pipe work during the transportation. Locate the wine cooler away from direct sunlight and sources of heat (stove, heater, radiator, etc.). Direct sunlight may affect the acrylic coating and heat sources may increase electrical consumption. Extreme cold ambient temperatures may also cause the unit not to perform properly.
- Avoid locating the unit in moist areas.
- Plug the wine cooler into an exclusive, properly installed-grounded wall outlet. Do not under any circumstances cut or remove the third (ground) prong from the power cord. Any questions concerning power and/or grounding should be directed toward a certified electrician or an authorized Products service center.

➤ **Attention**

- Store wine in sealed bottles;
- Do not overload the cabinet;
- Do not open the door unless necessary;
- Do not cover shelves with aluminum foil or any other shelf material which may prevent air circulation;
- Should the wine cooler be stored without use for long periods it is suggested, after a careful cleaning, to leave the door ajar to allow air to circulate inside the cabinet in order to avoid possible formations of condensation, mold or odors.

➤ **Ambient Room Temperature Limits**













This appliance is designed to operate in ambient temperatures specified by its temperature class marked on the rating plate.

Class	Symbol	Ambient Temperatures range(°C)
Extended Temperate	SN	+ 10 to + 32
Temperate	N	+ 16 to + 32
Subtropical	ST	+ 16 to + 38
Tropical	T	+ 16 to + 43









OPERATING THE APPLIANCE

OPERATING YOUR WINE COOLER AND SETTING THE TEMPERATURE CONTROL



-  Child Lock
The default setting is unlock when appliance connect the power. Press and hold the button for 3 seconds to lock it. And press again and hold this button for 3 seconds for unlock.
-  Changing the running modes
The default setting is “STD” (Standard) mode when appliance connect the power.
 - Each press  button to alternate the three modes: STD, ECO and DEMO.
 - Press and hold  for three seconds, system enter into Sab mode. Press and hold again  for 3 seconds. System alternate to STD mode.
-  Changing the LED light color
The LED light and button backlight default setting is white color when appliance connect the power.
Each press  button. The LED light and button backlight alternated three colors: white1. blue and white2.
-  Changing the LED light mode
The system opens the door and turns on the light by default, closing the door and turning off the light.
Each time you click, the system will be between the default/24hr/30Min/1Min.
Default:50%brightness after opening the door, and extinguishing after closing the door.
24hr:100%brightness after opening the door, according to the set light brightness after closing the door, the light will be on for 24 hours.
30Min:100%brightness after opening the door, according to the set light brightness after closing the door, the light will be on for 30minutes.
1Min:100%brightness after opening the door, according to the set light brightness after closing the door, the light will be on for 1minutes.
-  Adjusting the LED light brightness.
In24hr/30Min/1Min light mode, the brightness of the door is 100%, and the default brightness after closing the door is 50%.
Each press the  button. The brightness alternate between 50%. 75% and 100%.
-  Power button
Press and hold this button for 3 seconds to turn off the appliance. With a slight press again to turn it on.
-  Upper zone  temperature setting (up button).
Press this button to increase the temperature by one degree increments. When the setting reach the temperature upper limit value 64°F/18°C. The set temperature will no change again.

OPERATING THE APPLIANCE

8.  Upper zone  temperature setting (down button).
Press this button to lower the temperature by one degree increments. When the setting reach the temperature lower limit value 41°F/5°C. The set temperature will no change again.
9.  Lower zone  temperature setting (up button)
Press this button to increase the temperature by one degree increments. When the setting reach the temperature upper limit value 64°F/18°C. The set temperature will no change again.
10.  Lower zone  temperature setting (down button)
Press this button to lower the temperature by one degree increments. When the setting reach the temperature lower limit value 41°F/5°C. The set temperature will no change again.
11. To switch between the Celsius or Fahrenheit.
Press and hold  and  for 3 seconds to switch between C and F. The indicator light will illuminate on the desired temperature setting.
Temperature control range: upper zone:41-64°F/5-18°C,lower zone:41-64°F/5-18°C.
The upper/lower compartment temperature preset at the factory is 54°F/12°C.
The product has power off memory function.

➤ **Temperature Alarm**

If inner temperature is higher than 73°F/23°C, The “HI” is shown in display panel, and the buzzer alarm after one hour continuously. It inform that the inner temperature is too high, please check the reason.

If inner temperature is lower than 23°F/0°C, The “LO” is shown in display panel, and the buzzer alarm .

➤ **Temperature Recollection Function**

In the event of a power interruption, wine cooler can remember the previous temperature settings, and when the power is recovery, the cooler temperature will go back the same setting temperature as power off .

➤ **Door Ajar Alarm Function**

If the door is not closed completely the alarm will sound after 1 minutes. Please close the door completely to avoid the loss of cold energy.

➤ **Note**

If the unit is unplugged, power lost, or turned off, you must wait 3 to 5 minutes before restarting the unit. If you attempt to restart before this time delay, the Wine Cooler will not start.

When you use the wine cooler for the first time or restart the wine cooler after having been shut off for a long time, there could be a few degrees variance between the temperature you select and the one indicated on the LED readout. This is normal and it is due to the length of the activation time. Once the wine cooler is running for a few hours everything will be back to normal.

BEVERAGE OR WINE CHART

➤ BEVERAGE OR WINE CHART

The maximum number of bottles that can be loaded into the cabinet are for information only; this information is not contractual; it provides a means for rapidly estimating the size of the device.

Bottle loading proposal#1
 Total: 111 bottles (Bordeaux)

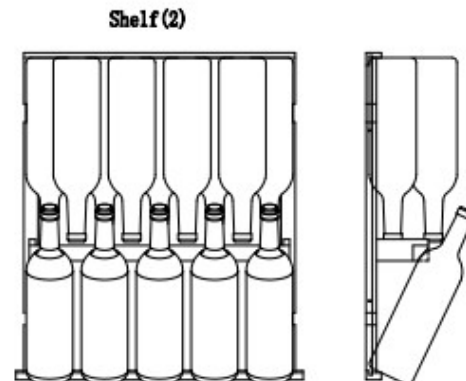
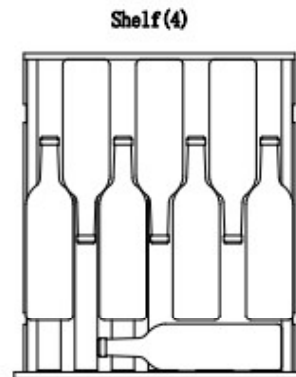
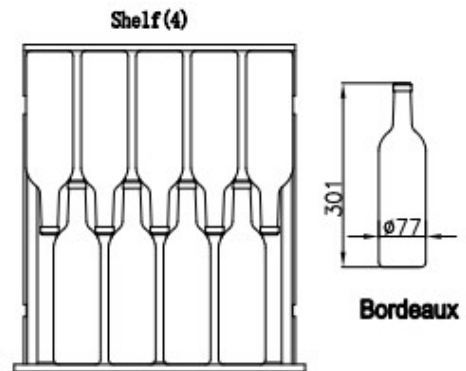
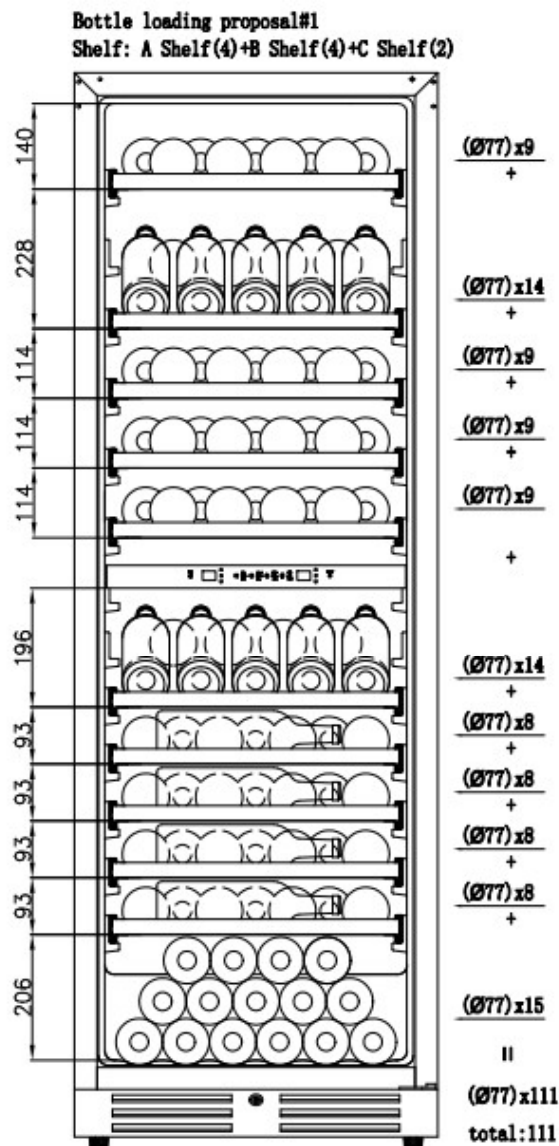

BEVERAGE OR WINE CHART

Bottle loading proposal#2

Total: 115 bottles (Bordeaux 23 bottles and Burgundy 92 bottles)

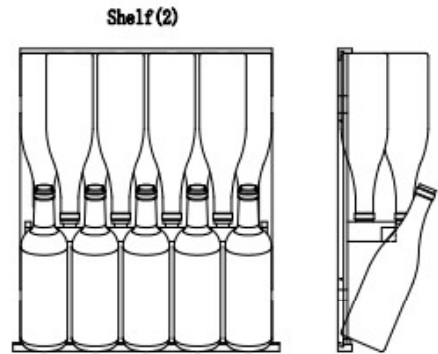
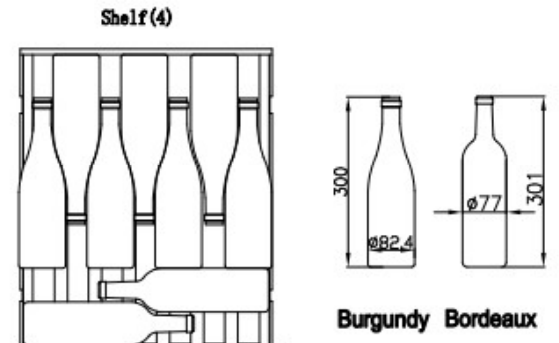
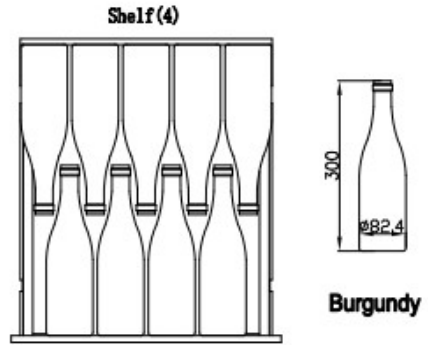
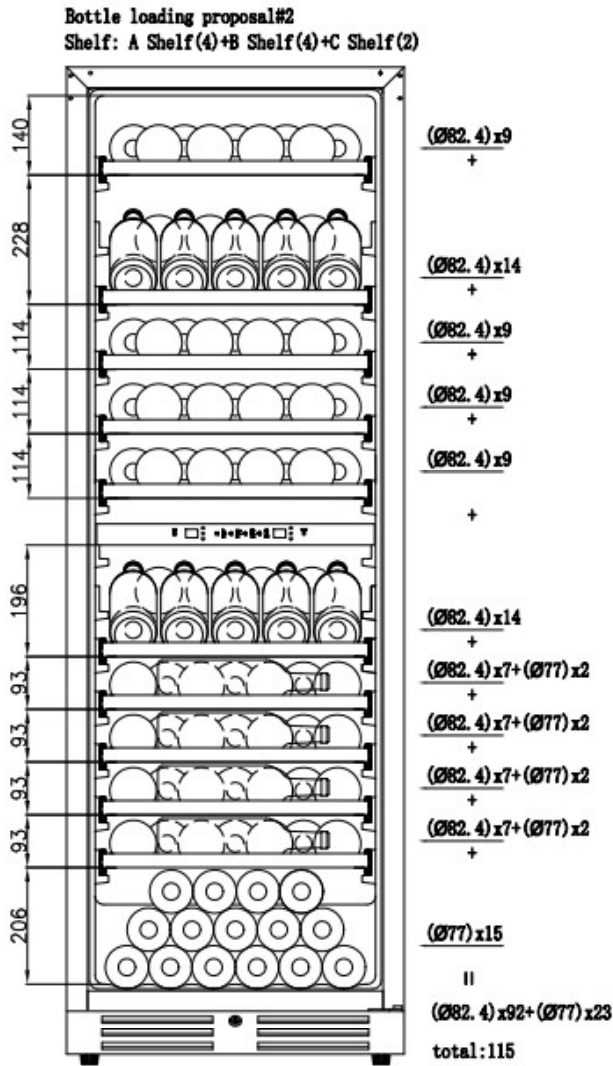

BEVERAGE OR WINE CHART

Bottle loading proposal#3

Total:115 bottles (Bordeaux 23 bottles and Champagne 92 bottles)

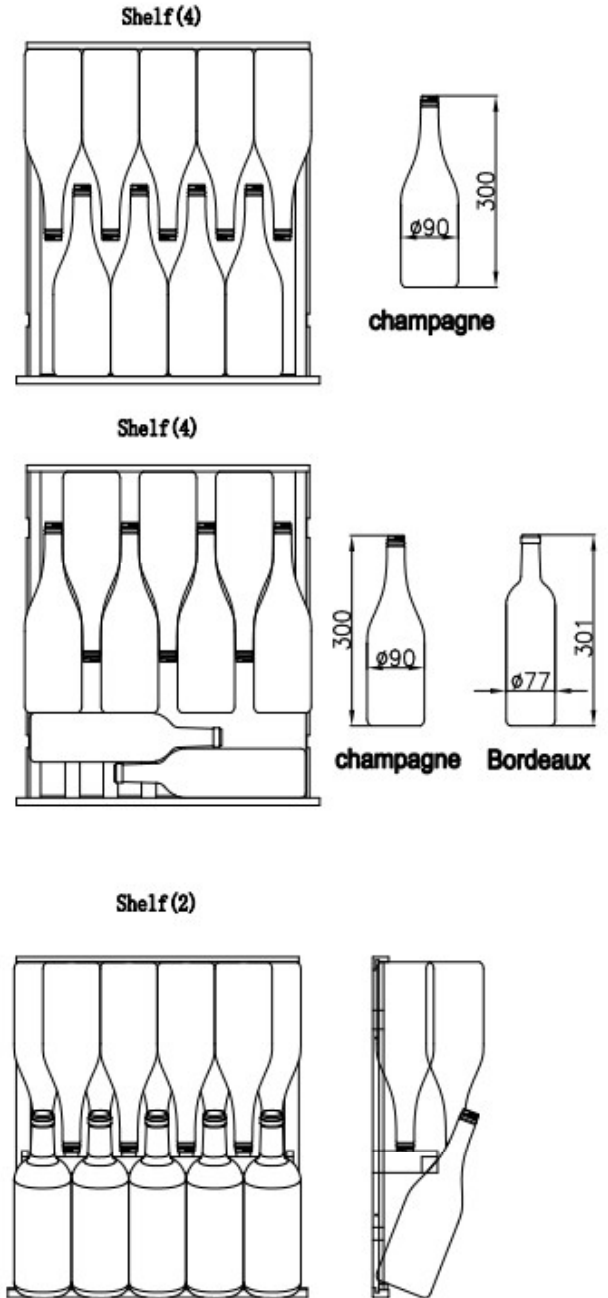
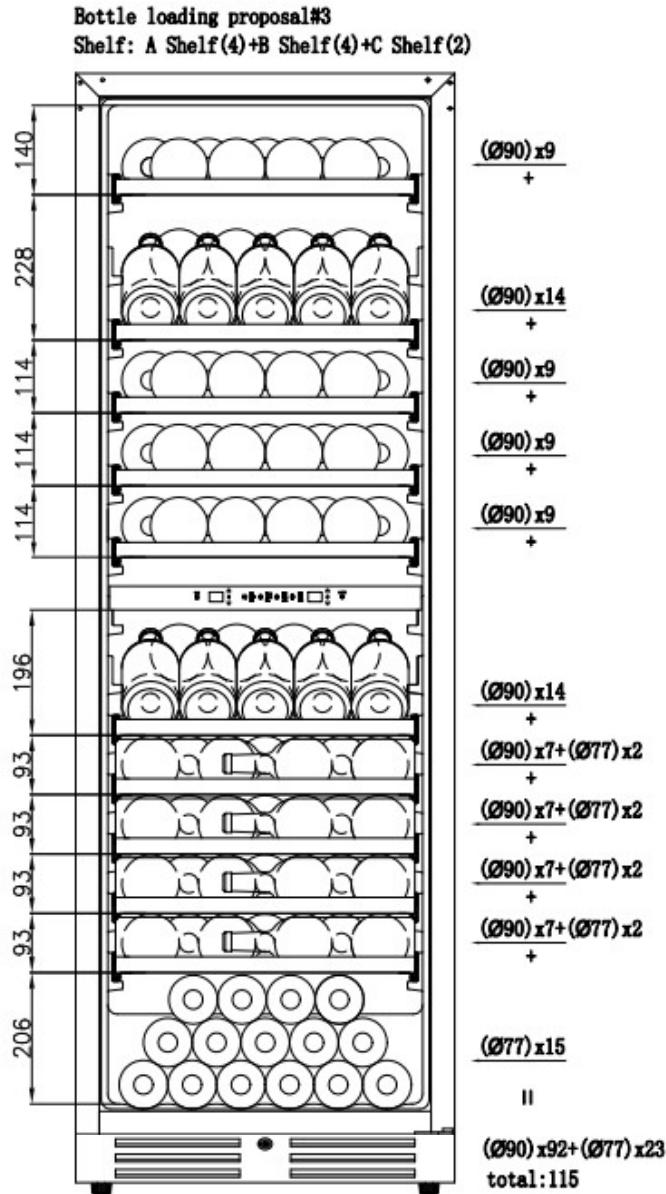

RECOMMENDED DRINKING TEMPERATURE

➤ RECOMMENDED DRINKING TEMPERATURE

The following (approximate) temperatures are recommended for wine drinking:

- | | |
|---|---------|
| ● For storing ALL TYPES OF WINES | 12–14°C |
| ● Champagne NV, Sparkling | 6°C |
| ● Champagne Vintage | 10°C |
| ● Dry White Semillon, Sauvignon Blanc | 8°C |
| ● Dry White Gewürztraminer, Riesling | 10°C |
| ● Dry White Chardonnay | 10°C |
| ● Vintage Chardonnay | 14°C |
| ● Sweet White Sauternes Monbaillac, Late Harvest ice wine | 10°C |
| ● Sweet whites vintage Sauternes | 14°C |
| ● Beaujolais | 13°C |
| ● Red Pinot Noir | 16°C |
| ● Vintage Pinot Noir red | 18°C |
| ● Red Grenache, Syrah | 16°C |
| ● Red Cabernet, Merlot, French, Australian, New Zealand, | 16°C |
| ● Chilean, Argentinean, Italian, Spanish, Californian | 18°C |

CARE AND MAINTENANCE

➤ Cleaning Your Wine Cooler

- Turn off the power, unplug the appliance, and remove all items including shelves and rack.
- Wash the inside surfaces with a warm water and baking soda solution. The solution should be about 2 tablespoons of baking soda to a quart of water.
- Wash the shelves with a mild detergent solution.
- Wring excess water out of the sponge or cloth when cleaning area of the controls, or any electrical parts.
- Wash the outside cooler with warm water and mild liquid detergent. Rinse well and wipe dry with a clean soft cloth.

➤ Power Failure

- Most power failures are corrected within a few hours and should not affect the temperature of your appliance if you minimize the number of times the door is opened. If the power is going to be off for a longer period of time, you need to take the proper steps to protect your contents.

➤ Vacation Time

- Short vacations: Leave the wine cooler operating during vacations of less than three weeks.
- Long vacations: If the appliance will not be used for several months, remove all items and turn off the appliance. Clean and dry the interior thoroughly. To prevent odor and mold growth, leave the door open slightly: blocking it open if necessary.

➤ Moving Your Wine Cooler

- Remove all items.
- Securely tape down all loose items (shelves) inside your appliance.
- Turn the adjustable leg up to the base to avoid damage.
- Tape the door shut.
- Be sure the appliance stays secure in the upright position during transportation. Also protect outside of appliance with a blanket, or similar item.

➤ Energy Saving Tips

- The wine cooler should be located in the coolest area of the room, away from heat producing appliances, and out of the direct sunlight.

➤ Availability Of Spare Parts

- Thermostats, temperature sensors, printed circuit boards and light sources are available for a minimum period of seven years after placing the last unit of the model on the market.
- Door handles, door hinges, trays and baskets for a minimum period of seven years and door gaskets for a minimum period of 10 year, after placing the last unit of the model on the market.

CARE AND MAINTENANCE

PROBLEMS WITH YOUR WINE COOLER ?

You can solve many common wine cooler problems easily, saving you the cost of a possible service call. Try the suggestions below to see if you can solve the problem before calling the service.

TROUBLESHOOTING GUIDE

PROBLEM	POSSIBLE CAUSE
wine cooler does not operate.	Not plugged in. The appliance is turned off. The circuit breaker tripped or a blown fuse.
wine cooler is not cold enough.	Check the temperature control setting. External environment may require a higher setting. The door is opened too often. The door is not closed completely. The door gasket does not seal properly.
Turns on and off frequently.	The room temperature is hotter than normal. A large amount of contents has been added to the wine cooler . The door is opened too often. The door is not closed completely. The temperature control is not set correctly. The door gasket does not seal properly.
The light does not work.	Not plugged in. The circuit breaker tripped or a blown fuse. The bulb has burned out. The light button is "OFF".
Vibrations.	Check to assure that the wine cooler is level.
The wine cooler seems to make too much noise.	The rattling noise may come from the flow of the refrigerant, which is normal. As each cycle ends, you may hear gurgling sounds caused by the flow of refrigerant in your wine cooler . Contraction and expansion of the inside walls may cause popping and crackling noises. The wine cooler is not level.
The door will not close properly.	The wine cooler is not level. The door was reversed and not properly installed. The gasket is dirty. The shelves are out of position.

CARE AND MAINTENANCE

Before disposal of the appliance.

1. Disconnect the main plug from the main socket.
2. Cut off the main cable and discard it.

	Correct disposal of this product
	<p>This symbol on the product, or in its packaging, indicates that this product may not be treated as household waste. Instead, it should be taken to the appropriate waste collection point for the recycling of electrical and electronic equipment. By ensuring this product is disposed of correctly, you will help prevent potential negative consequences for the environment and human health, which could otherwise be caused by the inappropriate waste handling of this product. For more detailed information about the recycling of this product, please contact your local council, your household waste disposal service, or the shop where you purchased the product.</p>

WARRANTY



Warranty & Service

This product has been manufactured by Thor International, 4651 E Airport Dr, Ontario, CA 91761

For Customer Service, please call (877) 288 - 8099

For the most up to date warranty and service policy, please refer to our website
WWW.THORKITCHEN.COM/WARRANTY-REGISTRATION

For in-warranty service requests, please visit our website at
WWW.THORKITCHEN.COM/SERVICE

Please Note: You must provide proof of purchase or installation date for any in-warranty service requests

We Stand Behind the Quality of Our Appliances.



Reliability and customer satisfaction are our top priorities. We offer a solid two-year warranty on both parts and labor. Enjoy professional-grade performance with the confidence that we've got you covered.

Warranty Registration Made Easy.

01 Scan the QR Code or visit thorkitchen.com/register-your-product.

02 Input your purchase and product information and select register.

03 That's it. You're all set. Enjoy!

Questions: service@thorinternational.com



WARRANTY



PARTS

