

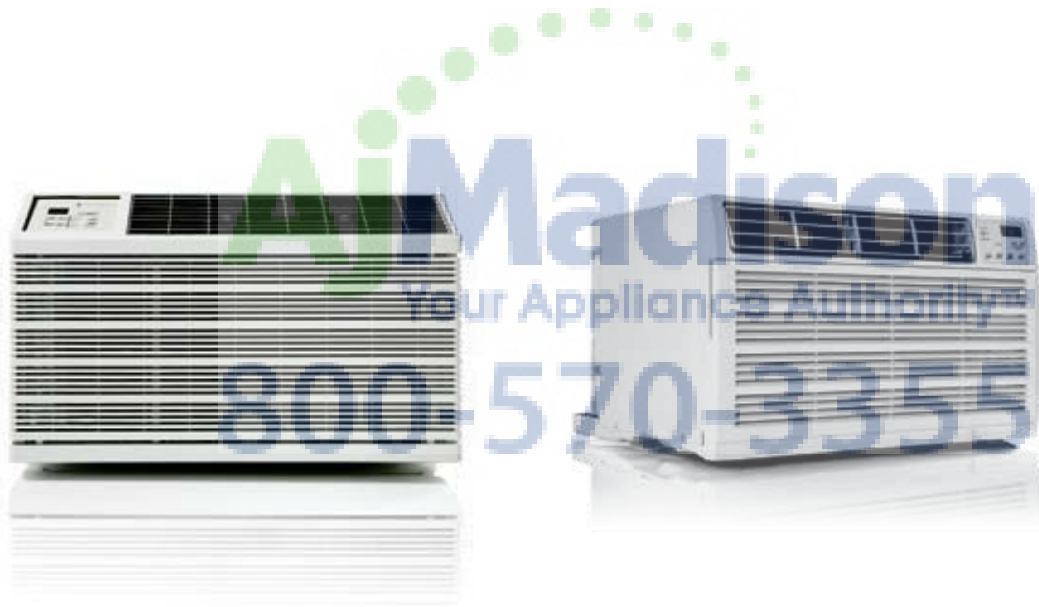

FRIEDRICH

1883



# THRU-THE-WALL AIR CONDITIONERS



UNIVERSAL 26" OR PERFECT 27" FIT

# High efficiency thru-the-wall air conditioners for commercial and residential installations

## When should you install a solid side sleeve?

Solid Side wall sleeve allows for installation in thick exterior walls where the installation of room air units with side vents would effect performance and may even void the warranty.

ROOM AIR CONDITIONER  
BLOCKED SIDE VENTS RESTRICT AIR FLOW



FRIEDRICH THRU-THE-WALL  
SOLID-SIDE SLEEVE (NO SIDE VENTS) CAN BE  
INSTALLED IN THICKER WALLS AND CAN BE  
POSITIONED FLUSH WITH EXTERIOR WALL.

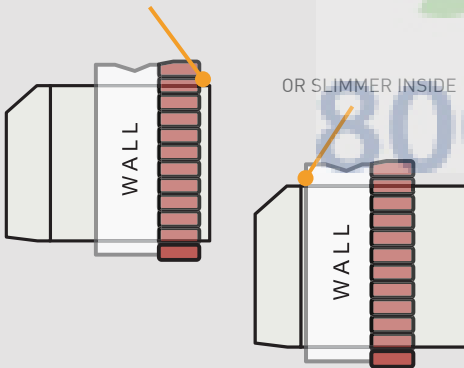

THRU-THE-WALL UNITS CAN MOUNT FLUSH WITH EXTERIOR WALLS FOR A SLEEK APPEARANCE, AS WELL AS UNOBSTRUCTED WINDOW VIEWS.

(WALLMASTER WSD SLEEVE SHOWN WITH OPTIONAL ARCHITECTURAL GRILLE. UNI-FIT GRILLE HAS DIFFERENT APPEARANCE.)

### THRU-THE-WALL MODELS

		WallMaster®	Uni-Fit®
OVERVIEW	Sleeve size	Fits 27" sleeves	Fits 26" sleeves and sleeves as small as 24 1/2"
	Applications	RESIDENTIAL OR LIGHT COMMERCIAL	RESIDENTIAL OR LIGHT COMMERCIAL
COMFORT & CONVENIENCE	Perfect fit for Fedder's 27" sleeves	Y	—
	Top mounted controls	Y	—
	Electronic controls	Y	Y
	Programmable timer	24 hr.	12 hr.
	Remote control	Y	Y
	Auto restart when power is interrupted	Y	Y
	Smart Fan auto adjusting fan	Y	—
	Upward angled air discharge	Y	—
	Air flow direction control	4-way	6-way
Fan speeds	3	3	
SOUND REDUCTION TECHNOLOGY	Steel inner wall and extra dense insulation	Y	Steel inner wall
	Vibration isolating design and components	Y	Y
	Superior airflow design	Y	—
EARTH FRIENDLY	Energy Star models	Y	Y
	Environmentally friendly R-410A	Y	Y
	Energy saver switch	Y	Y
HEALTH	Washable, antimicrobial air filter	Y	Y
	Stale air exhaust	—	Y
SAFETY	EntryGard anti-intrusion protection	Y	—
	Insect barrier	Y	—
INSTALLATION	Slide-out chassis	Y	Y
	Power cord direction	Left	Right
	Concealed power cord option	Y	—
	Internal drain kit option	Y	—
	Baffle adapter kit	Y	Y
	Condensate drain kit	Y	—

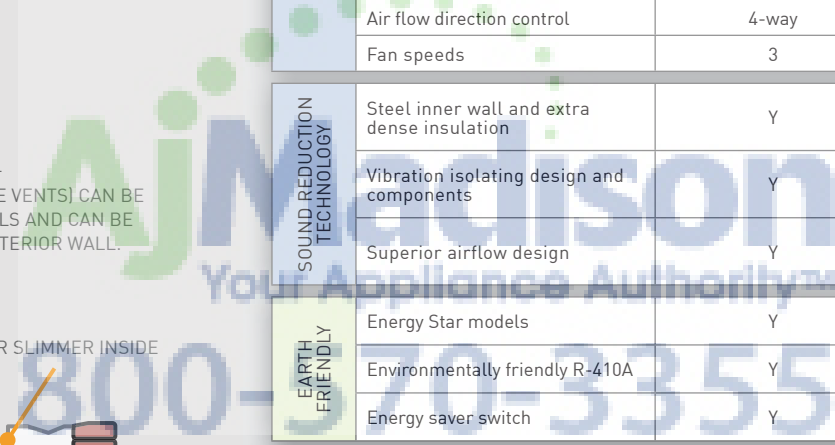

# WallMaster®

A perfect fit in Friedrich and existing 27" sleeves. Commercial grade quality unit is ideal for installation in new construction, retrofits and remodels.

## Comfort & Convenience

- Easy-to-reach, top mount controls
- Remote control
- 24 hour programmable timer
- Smart Fan auto-adjusts fan speed to maintain desired temperature
- 3 speed fan
- Washable, antimicrobial filter
- Auto restart
- Electronic defrost control
- Insect barrier
- Reversible louver allows a second airflow option



## Durability & Quality

- Rotary compressors provide quiet, dependable performance
- Premium stamped exterior grille
- Dense blower insulation
- Rifled copper tubing
- Impact resistant front cover
- High tech fins with sine wave lanced louvers increase energy efficiency by increasing surface area for heat exchange



## Energy Savings

- Money Saver® setting saves money by operating the fan only when needed
- Six Energy Star models



ANGLED AIR DISCHARGE FOR SUPERIOR AIR DISTRIBUTION WHEN THE UNIT IS INSTALLED LOW ON A WALL. REVERSIBLE LOUVER FOR HIGH WALL INSTALLS.

## Installation Features

- Mounts flush with the exterior wall for a neat appearance
- Ideal for thicker wall installations, where side fins don't fit
- A high efficiency replacement for 27" sleeves including Fedders A and B\*. Sleeve measures 27" W x 16 3/4" H



WSD SLEEVE SHOWN WITH EXTERIOR GRILLE IN PLACE. GRILLE IS PREMIUM, STAMPED GALVANIZED STEEL WITH POWDER COAT PAINT.

## Accessories

- WSD sleeve (sleeve is required for new installation and is sold and shipped separately)
- Architectural grille
- Drain kit
- Interior drain kit
- Subbase
- Baffle adapter kit

## WALLMASTER®

**COOLING**  
7,800-14,500 Btu  
Up to 9.9 EER

**HEATING**  
7,300-11,000 Btu

Sleeve Dimensions	Friedrich WSD Sleeve	Fedders A Sleeve	Fedders B Sleeve*
Height (inches)	16 3/4	16 3/4	16 3/4
Width (inches)	27	27	27
Depth (inches)	16 3/4	16 3/4	19 3/4

Chassis requires WSD sleeve (sold and shipped separately)

\*Installation in Fedders B sleeve requires a baffle kit. See BAK accessory under accessories.

Aj Madison  
Your Appliance Authority™  
800-570-3355

# Uni-Fit®

Universal fit for easy replacement in existing 24 1/2", 26" or 27" sleeves.



## Comfort & Convenience

- Six-way air flow control
- Stale air exhaust
- Remote control
- 12 hour programmable timer
- 3 speed fan
- Auto restart
- Washable antimicrobial filter
- Defrost control



## Installation Features

- Universal fit trim ring
- Sleeve designed to fit a standard 26" opening and sleeves as small as 24.5"

## Accessories

- USC sleeve (sleeve is required for new installation and is sold and shipped separately)
- Replacement exterior grille for use with existing sleeve



## Energy Savings

- Money Saver® setting saves money by conserving energy
- Six Energy Star models

## Durability & Quality

- Rotary compressors provide quiet, dependable performance
- Seacoast protection for corrosion resistance in harsh environments



USC SLEEVE SHOWN WITH EXTERIOR GRILLE IN PLACE

TRIM RING



**IMPORTANT:**  
1" gap on sides and 1/2" gap at top, which allows installation into varying sleeve sizes, can be covered by two-piece trim ring that fits over the chassis front. Trim ring comes standard with chassis.

## UNI-FIT®

**COOLING**  
8,000-13,000 Btu  
Up to 9.6 EER

**HEATING**  
3,850-11,200 Btu

Sleeve Dimensions	Friedrich USC Sleeve	Amana	Carrier (51S Series)	Fedders/ Emerson/ Friedrich WSD	Emerson/ Fedders	GE/ Hotpoint	Whirlpool	White-Westinghouse/ Frigidaire/ Carrier (52F Series)
Height (inches)	15 1/2	15 5/8	16 7/8	16 3/4	15 3/4	15 5/8	16 1/2	15 1/4
Width (inches)	25 7/8	26	25 3/4	27	26 3/4	26	25 7/8	25 1/2
Depth (inches)	16 3/4	16 7/8	18 5/8	16 3/4 or 19 3/4	15	16 7/8	17 1/8 or 23	16, 17 1/2 or 22

Chassis requires USC sleeve (sold and shipped separately)

# Accessories / Installation Information

## WallMaster® 27" Sleeve Exterior Grilles



**WSD Sleeve Standard Grille**  
Premium, stamped galvanized steel grille with powder coat paint. Ships with sleeve. Galvanized steel inner and outer weather panels also ship with sleeve.



**WSD Sleeve Optional Architectural Grille- AG**

**IMPORTANT:**  
Operating the air conditioner with incorrect rear grille or without Baffle Adapter Kit (on 19 3/4" deep sleeve) will recirculate discharge air and cause compressor overload to trip. This will cause the unit to shut down temporarily and may lead to premature compressor failure.

**CORRECT Vertical Louvers**

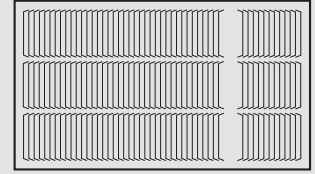

**INCORRECT Horizontal Louvers**

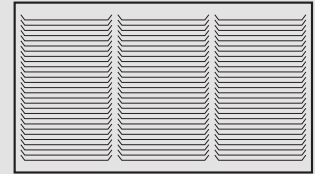

## Installation Accessories (27" sleeve models only)

### DK / Drain Kit

Installed at the back of the unit and allows for attachment to condensate disposal system, if necessary or desired.

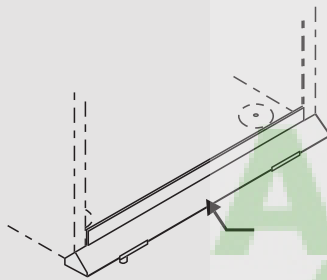

### SB / Sub Base (Hides power cord)

Used as a base for the unit when it is desired to place the cord and receptacle within the installation, or simply as a base for the unit when mounted low in the wall or in walls less than 6 inches deep.

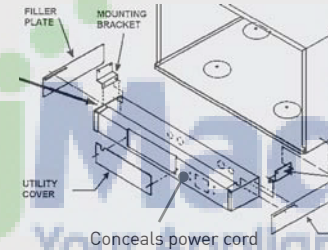

### IDK / Internal Drain Kit

New construction applications where a condensate drain system has been built into the wall interior.

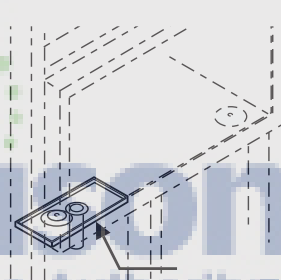

### BAK / Baffle Adapter Kit

Necessary when installing in a sleeve deeper than 16 3/4" deep, such as Fedders B sleeve (19 3/4" deep).

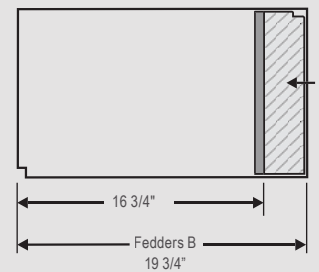

## Uni-Fit® 26" Sleeve Exterior Grilles



**USC Sleeve Standard Grille**



**Sleeve shown with Replacement Grille**

**STANDARD GRILLE** - Ships with USC sleeve  
Expanded aluminum grille designed for use with USC sleeve.

**REPLACEMENT GRILLE** - Ships with US/UE chassis  
Black plastic for use on existing sleeves without any grille.

**IMPORTANT:**  
When installing into an existing sleeve, consult Installation Section of your Installation/Operation Manual to determine whether or not the grille needs to be replaced and/or a baffle adapter should be used.

## Sleeve/Chassis Dimensions

Model	Sleeve			Depth with Front	Minimum Extension Into Room	Minimum Extension Outside	Thru-the-wall Finished Hole		
	Height	Width	Depth				Height	Width	Max. Depth
<b>WALLMASTER</b>									
WSD Sleeve	16 3/4"	27"	16 3/4"	23"	7 1/2"	9/16"	17 1/4"	27 1/4"	15 5/16"
Chassis	15 3/4"	26 1/2"	21"	22"	-	-	-	-	-
<b>UNI-FIT</b>									
USC Sleeve	15 1/2"	25 7/8"	16 3/4"	20 1/2"	-	1/2"	15 3/4"	26 1/8"	16 1/4"
US Chassis	14 3/8"	24"	18 1/2"	20 1/8"	3 3/4"	-	-	-	-
UE Chassis	14 3/8"	24 5/8"	18"	19 5/8"	3 1/2"	-	-	-	-

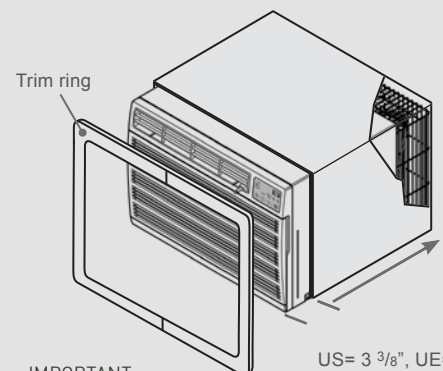

**IMPORTANT:**  
US chassis w/front fully installed into USC sleeve extends into room 3 3/8". UE chassis w/front fully installed into USC sleeve extends into room 2 7/8". 1" gap on sides and 1/2" gap at top can be covered by two-piece trim ring that fits over the chassis front

# Specifications



Model	Cooling Capacity Btu	Heating Capacity Btu	Volts Rated	Cooling Amps	Cooling Watts	Heating Amps	Heating Watts	Energy Efficiency Ratio EER	Estimated Yearly Operating Cost	Moisture Removal Pints/HR	Room Side Air Circulation CFM	Sleeve	Net Weight Lbs
<b>WALLMASTER</b>													
<i>Cool only</i>													
WS08C10	7800	NA	115	7.1	788	NA	NA	9.9	†	1.2	250	WSD	93
WS10C10	9700	NA	115	10.0	1032	NA	NA	9.4	\$82	2.4	257	WSD	103
WS12C10	11900	NA	115	11.8	1266	NA	NA	9.4	\$101	3.3	295	WSD	112
WS10C30	9500/9200	NA	230/208	4.5/4.7	989/958	NA	NA	9.6/9.6	\$79	1.5	300	WSD	101
WS13C30	12600/12300	NA	230/208	6.3/6.7	1340/1309	NA	NA	9.4/9.4	\$107	3.6	290	WSD	109
WS15C30	14500/14500	NA	230/208	8.3/8.2	1706/1706	NA	NA	8.5/8.5	\$136	4.2	290	WSD	119
<i>Heat Pump</i>													
WY09C33	9300/9000	7300/7300	230/208	4.4/4.7	989/957	3.8/4.0	839/793	9.4/9.4	\$79	2.1	250	WSD	103
WY12C33	12000/11800	9350/9200	230/208	6.1/6.4	1395/1372	4.8/5.1	1062/1010	8.6/8.6	\$111	2.6	275	WSD	111
<i>Cool with Electric Heat</i>													
WE10C33	9500/9200	11000/9100	230/208	4.5/4.7	989/958	16.0/14.7	3550/2950	9.6/9.6	\$79	1.5	300	WSD	121
WE13C33	12600/12300	11000/9100	230/208	6.3/6.7	1340/1309	16.0/14.7	3550/2950	9.4/9.4	\$107	3.6	290	WSD	107
WE15C33	14500/14500	11000/9100	230/208	8.3/8.8	1706/1706	16.0/14.7	3550/2950	8.5/8.5	\$136	4.2	290	WSD	116
<b>UNI-FIT</b>													
<i>Cool Only</i>													
US08C10	8000	-	115	7.5	830	-	-	9.6	\$66	2.2	260	USC	73
US10C10	9800	-	115	9.6	1040	-	-	9.4	\$83	3.2	285	USC	78
US12C10	11500	-	115	11.2	1220	-	-	9.4	\$97	3.8	290	USC	80
US10C30	10000/9800	-	230/208	4.7/5.2	1060/1040	-	-	9.4/9.4	\$85	3.2	285	USC	78
US12C30	11500/11200	-	230/208	5.6/6.0	1220/1190	-	-	9.4/9.4	\$97	3.8	290	USC	80
US14C30	13000/12600	-	230/208	7.0/7.5	1530/1480	-	-	8.5/8.5	\$122	4.0	310	USC	87
<i>Cool with Electric Heat</i>													
UE08C13	8000	3850	115	7.5	830	10.7	1230	9.6	\$66	2.2	260	USC	73
UE10C33	10000/9800	11200/9200	230/208	4.7/5.2	1060/1040	15.3/14.0	3500/2900	9.4/9.4	\$85	3.2	285	USC	78
UE12C33	11500/11200	11200/9200	230/208	5.6/6.0	1220/1190	15.3/14.0	3500/2900	9.4/9.4	\$97	3.8	290	USC	80

WallMaster Heat Pump heating information (shown in red) indicates heat pump heating performance. WallMaster Electric Heat heating information (shown in red) indicates electric heat strip performance. For WallMaster Heat Pump electric heating performance refer to corresponding WallMaster Electric Heat model.

## WALLMASTER HEAT PUMP

**HEATING PERFORMANCE:** Change-over from heat pump operation to resistance operation on models indicated is automatic at a preset outside ambient temperature of approximately 35°F.

Calculate the heat loss of the space to be heated. As long as the heat loss does not exceed the resistance heating capacity rating of the unit, the heating performance will be satisfactory.

Note: all models will produce condensate. If condensate disposal is desired, an optional drain kit is available.

**DEFROST CONTROL:** Initiated at 30°F (outdoor coil temperature) and terminated at 43°F (outdoor coil temperature). During defrost, the compressor stops and the electric heat starts, then operates with the fan to maintain indoor comfort. Below 43°F, the unit remains in electric heat mode.

**DEFROST DRAIN:** Drain automatically opens at approximately 50°F to prevent condensate from freezing inside drain pan.

## Plug Face/ Circuit Rating

WallMaster Model Number	Uni-Fit Model Number	Circuit Rating Breaker or T-D Fuse	Plug Face (NEMA#)	Power Cord Length (ft.)	Wall Outlet Appearance
WS08C10, WS10C10, WS12C10	US08C10, UE08C13 US10C10, US12C10	125V - 15A	5 - 15P	6	
WS10C30, WS13C30, WS15C30	US10C30, US12C30, US14C30	250V - 15A	6 - 15P	4	
WE10C33, WE13C33, WE15C33, WY09C33, WY12C33	UE10C33, UE12C33	250V - 20A	6 - 20P	4	

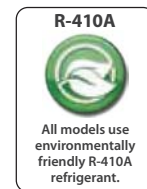

Power cords are located on front left of WallMaster models and on front right of Uni-Fit models.

Due to continuing research in new energy-saving technology, specifications are subject to change without notice. As an ENERGY STAR® partner, Friedrich Air Conditioning Co. has determined that the selected ENERGY STAR® models meet the ENERGY STAR® guidelines for energy efficiency.

Estimated yearly operating cost based on a 2007 national average electricity cost of 10.65 cents per kWh. † The estimated yearly operating cost of this model was not available at the time the range was published.



Friedrich Air Conditioning Co. | 10001 Reunion Place, Suite 500 | San Antonio, TX 78216 | 800.541.6645 | fax 210.546.0733  
www.friedrich.com