

Miele

TOUCHTRONIC

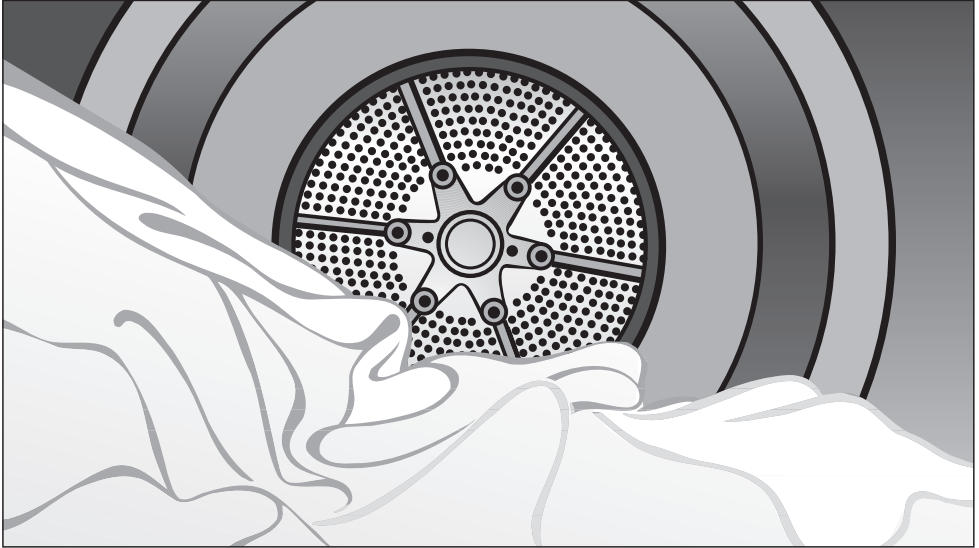

Operating and Installation Instructions Vented Dryer T 9800

To prevent accidents
and machine damage
read these instructions

before

installation or use.



M.-Nr. 06 640 591









Contents

IMPORTANT SAFETY INSTRUCTIONS	4
Control panel	6
Before loading the dryer	7
Fabric care labels	7
Drying tips	7
Use	8
1. Sort the laundry	8
2. Load the laundry	8
3. Select a program	10
4. Select an option	11
5. Start the program	12
6. Program end - Unload the laundry	13
Changing a running program	13
To cancel a program	13
Adding/removing laundry during a drying program	13
Program guide	14
Dryer Care	16
Cleaning the lint filter	16
Cleaning the exterior and the control panel	17
Stainless steel parts	17
Changing the light bulb	18
Frequently asked questions	19
General problems	19
Quick Guide	21

Frequently asked questions	21
Fault indicators	21
After sales service	23
Installation instructions	25
IMPORTANT SAFETY INSTRUCTIONS	26
Installation	27
Stand	27
Installation site	28
Transporting the dryer to the installation site.	29
Level the dryer.	29
Electrical connection	30
How to calculate the effective duct length.	32
Exhaust connection with a flexible exhaust hose or rigid pipe	35
Direct wall connection	36
Caring for the environment	37

IMPORTANT SAFETY INSTRUCTIONS

 **WARNING** - To reduce the risk of fire, electric shock, or injury to persons when using your appliance follow basic precautions, including the following:

-  Read all instructions before using the appliance.
-  Do not dry articles that have been previously cleaned, washed, soaked or spotted with gasoline, dry-cleaning solvents or other flammable or explosive substances. They may give off vapors that could ignite or explode.
-  Do not allow children to play on or in the appliance. Close supervision is necessary when the appliance is used near children.
-  Always close the door after use to prevent child or pet hazards.
-  Before this appliance is removed for service or discarded, remove the door to the drying compartment.
-  Do not reach into the dryer if the drum is moving.
-  Do not install or store this appliance where it will be exposed to the weather.
-  Do not lean on the door. The dryer may tip over.
-  Do not tamper with the controls.

 Do not repair or replace any part of the appliance or attempt any servicing unless specifically recommended in these Operating instructions. Repairs to electrical appliances should only be performed by qualified personnel. Incorrectly repaired machines may pose a considerable risk to the user.

 Do not use heat to dry articles containing foam rubber or similarly textured rubber-like materials, or items containing hair spray, nail polish remover or similar substances, wax or chemicals from buffing.

 Items with damaged fillings (e.g. pillows or jackets) should not be dried in the dryer. The filling can cause a fire.

 Clean the lint filter before or after each load.

 Keep the area around the air intake (toekick) and adjacent surrounding areas free from lint, dust and dirt.

 The interior of the machine and exhaust duct should be cleaned periodically by qualified personnel.

 Do not place items exposed to oils in your dryer. Items contaminated with oils may contribute to a chemical reaction that could cause the laundry to catch fire.

This dryer is intended for residential use only!

IMPORTANT SAFETY INSTRUCTIONS

GROUNDING INSTRUCTIONS

■ This appliance must be grounded. In the event of malfunction or breakdown, grounding will reduce the risk of electric shock by providing a path of least resistance for electric current.

This appliance is equipped with a cord having an equipment-grounding conductor and a grounding plug. The plug must be plugged into an appropriate outlet that is properly installed and grounded in accordance with all local codes and ordinances.

■ **WARNING** – Improper connection of the equipment grounding conductor can result in the risk of electric shock. Contact a qualified electrician if you are in doubt as to whether the appliance is properly grounded.

■ Do not modify the plug provided with the appliance, if it will not fit the outlet, have a proper outlet installed by a qualified electrician.

■ Do not install or use a dryer with visible damage.

■ This dryer must not be used without an exhaust hose, lint filter or a damaged lint filter.

■ Check regularly on the exhaust parts (e.g. wall vent duct, louvred wall vent, bends, etc.) if enough air gets through. Lint can collect and block the air flow.

If an exhaust hose is already installed, it should be checked before connected to the dryer.

■ Faulty components must only be replaced with original Miele spare parts.

■ If the power cord is damaged it must only be replaced by a Miele Service technician with a genuine Miele power cord.

Using accessories

■ The control panel must only be exchanged or removed by an authorized Miele Service Technician. If the control panel is not professionally exchanged there is a danger of electric shock and the machine may be damaged.

■ Only use genuine Miele accessories. If unapproved parts are used, guarantee, performance and product liability claims may become void.

SAVE THESE INSTRUCTIONS

Control panel

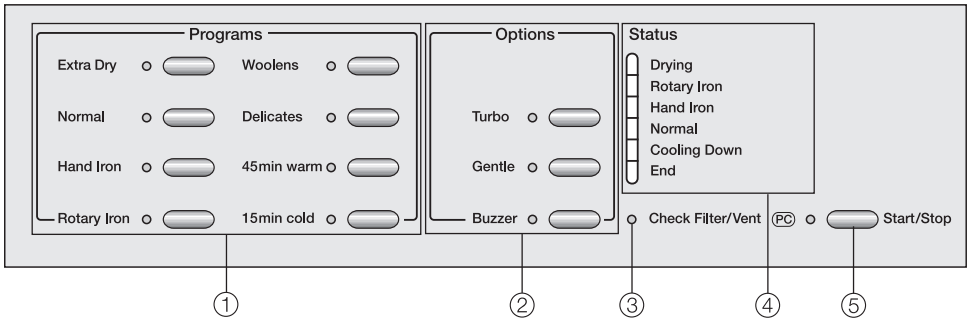

① Program buttons

To select a drying program

② Options buttons

Special features to enhance a drying program

③ Check Filter/Vent indicator

Indicates to clean the filter or vent

④ Status indicator

Shows the current cycle of the drying program

⑤ Start/Stop button

Starts and stops a program, or if pressed and held in cancels a program.

Flashes during program selection and lights continuously once the program starts.

Canada only

To exchange the control panel with a panel of a different language call Miele's Technical Service Dept. Only Miele's Tech. Service is authorized to change the control panel. See the back of the Operating manual for contact information.

Before loading the dryer

Clean the drum interior before the first use.

Fabric care labels

Before drying, check fabric care labels for special drying instructions.

- ☉ = Drying with a normal temperature
- ☺ = Drying with a low temperature
- ☒ = Do not dry in a tumble dryer

Drying tips

- Observe the maximum loads, see the "Program Guide".

Overloading the dryer will result in poor drying results and wrinkling.

- Dry delicate fabrics with the fabric care symbol ☺ with the "Gentle" option.
- Do not dry dripping wet items in the dryer. Spin the laundry after the wash for at least 30 seconds.
- Open jackets to allow even drying.
- Wool and wool blends tend to felt and shrink. Dry these items in the "Woolens" program.

- The fine cotton fabric or down filled items tends to shrink.
- Dry pure linen items only if it is advised on the fabric care label. The surface of the fabric otherwise tends to become "rough".
- Knitted fabrics (e.g. T-Shirts and underwear) tend to shrink when washed and dried for the first time. Do not overdry these fabrics.
- Permanent press and delicate fabrics tend to crease more the bigger the load size. For better drying results reduce the load size or select the "Delicates" program.
- Starched laundry can be dried in the tumble dryer. However, the amount of starch must be doubled during the wash.
- Wash new, colored items before drying for the first time and do not dry with light-colored items. These fabrics can "bleed" (also on plastic parts of the dryer). Colored lint could adhere to light-colored items.

Use

1. Sort the laundry

- Sort the laundry by desired dryness, fabric, size and similar residual moisture after spinning to assure even drying results.

 Do not dry items that may melt or ignite in the dryer such as plastics or rubber. They could melt and damage the laundry.

- Check hems and seams, so that no filling can fall out.
- Duvet covers and pillowcases should be fastened in order to prevent small items from rolling inside of them.
- Close zippers, hooks and eyelets.
- Tie up fabric belts and apron ties.
- Remove or sew up loose bra underwires.

2. Load the laundry

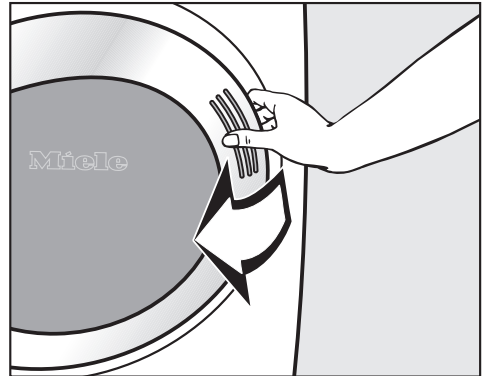

- Open the door.

2.1. Without the laundry basket

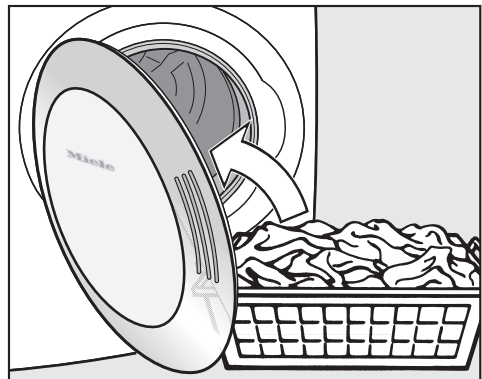

- Load the laundry loosely into the drum.

Do not overload the drum. Overloading strains the fabrics and leads to poor drying results.

2.2. With laundry basket

Reduce the load size to $\frac{1}{2}$ of a normal load.

Use the laundry basket to dry or air e.g. sport shoes.
The laundry basket is designed in such a way that it does not turn with the drum and avoids strain on the drying item.

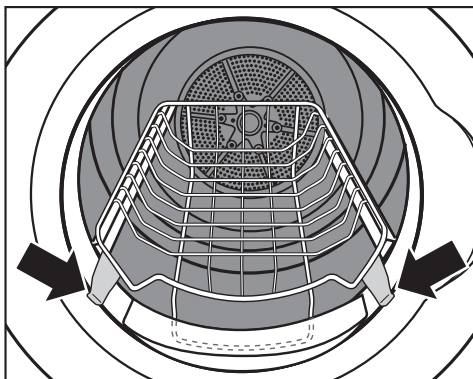

- Hang the laundry basket in the opening.

The laundry basket supports itself with the bottom in the dryer and is held in place with the front straps (arrows).

 Make sure **no sleeves, ties, belts, etc. stick out of the basket.** They might get entangled which could damage the laundry basket and the drum.

Drying with the laundry basket is only possible with the programs "45 min. warm" and "15 min. cold". All other programs are not suitable since the load sensor does not recognize a load and cancels the program.

Use

2.3. Close the door

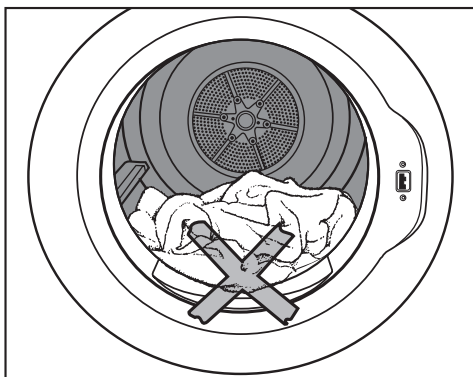

 To prevent fabric damage, check that laundry will not be caught in the closed door.

The lint filter must always be inserted in the door opening.

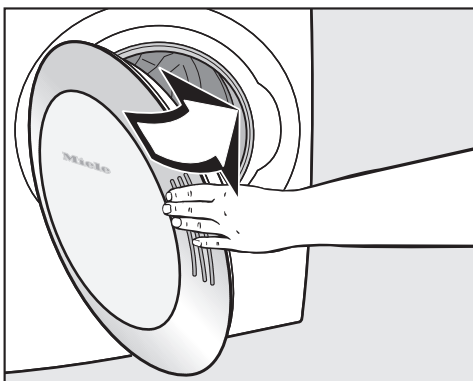

- Close the door with a firm swing and push it closed.

3. Select a program

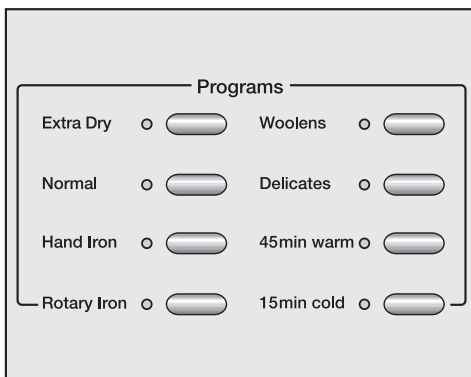

- Press the button of the desired program.
 - The respective program indicator lights.
 - "Options" indicators may be lit (Memory function).

4. Select an option

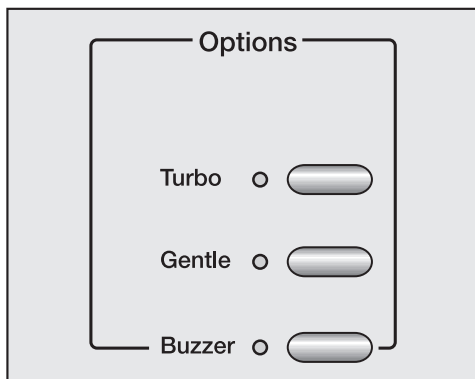

- Press any button.

The combination "Turbo/Gentle" is not possible.

Turbo

Heat resistant items (with fabric care symbol ☺) will be dried at a high temperature.

- Laundry will be dried faster.

Gentle

Items sensitive to high temperatures (with fabric care symbol ☹) will be dried at a low temperature.

- For delicate or permanent press fabrics, like acrylic.
- Extended program length

Buzzer

An signal sounds at the end of a program in intervals for up to 1 hour.

The buzzer can be turned on or off after the program starts.

The constant tone to signal a fault is independent from the turned on or off buzzer.

By pressing the "Buzzer" button the buzzer volume can be adjusted between normal - loud - off.

Use

5. Start the program

During the program selection the "Start/Stop" indicator flashes meaning that the program can be started.

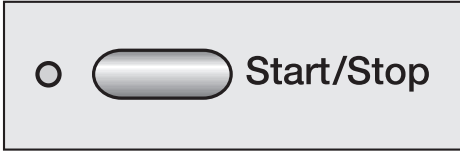

- Press the "Start/Stop" button.

The "Start/Stop" indicator lights.

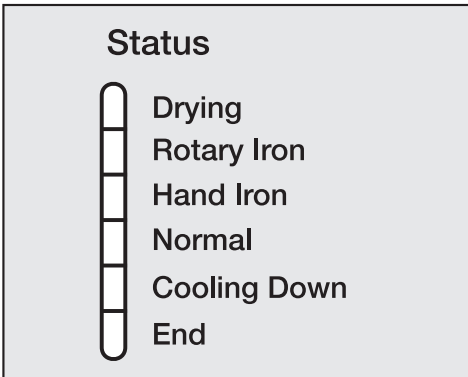

The "Status" indicator of the reached drying degree lights.

Before the end of a program

The heating phase is followed by the cooling phase which cools the laundry ("Cooling Down" indicator). Only after the cooling phase has ended has the program finished.

The "Woolens" program does not have a cooling phase.

6. Program end - Unload the laundry

The "Anti-crease/End" indicator will light at the end of the program and the buzzer will sound if it was selected.

The indicator of the reached drying degree lights (depending on program).

To avoid wrinkles, the drum turns in intervals for up to one hour, if the laundry is not immediately removed (Anti-crease).

- Open the door.

If the door remains open, the light goes off after a few minutes (saving energy).

- Remove the laundry.

 Check the drum for any missed pieces of laundry. Any items left in the dryer may be damaged because of over drying.

- Clean the lint filter after each use (see "Dryer care").

 Take care when inserting the lint filter not to hurt your fingers.

- Insert the lint filter with the yellow handle edge towards the drum.
- Close the door.

Changing a running program

A running program cannot be changed (protection from accidental changes).

To select a different program the running program must be canceled.

To cancel a program

- Press the "Start/Stop" button.

The laundry will be cooled in case a certain drying time and temperature were reached.

If you press the "Start/Stop" button again during the cooling phase, the "Anti-crease/End" indicator lights.

- Open and close the door.
- Select the new program.

Adding/removing laundry during a drying program

- Open the door.

 Do not touch the rear of the drum while adding or removing items! Danger of burns.

- Add or remove items.
- Close the door.
- Press the "Start/Stop" button.

Program guide

Extra Dry

Items	Multi-layered, mixed loads of sturdy cottons, e.g. towels, bath robes.
-------	--

Note	The "Extra dry" program should not be selected for jersey materials. Items may shrink.
------	--

Options	Turbo or Gentle, Buzzer
---------	-------------------------

Normal

Items	Single and multilayered cotton and linen laundry e.g. terry towels, beach towels, bath robes, T-Shirts, underwear, cotton bed linens, baby clothing, etc.
-------	---

Options	Turbo or Gentle, Buzzer
---------	-------------------------

Hand iron

Items	Cotton or linen fabrics to be left damp for easier ironing e.g. table cloths, bed linens, starched laundry, etc.
-------	--

Options	Turbo or Gentle, Buzzer
---------	-------------------------

Rotary iron

Items	Cotton or linen fabrics to be left damp for easier ironing. e.g. table cloths, bed linens, starched laundry, etc.
-------	---

Note	Roll up items until they are machine ironed, to keep them damp.
------	---

Options	Turbo or Gentle, Buzzer
---------	-------------------------

Program guide

Woolens	
Items	Woolen fabrics
Note	<ul style="list-style-type: none"> – Reduce the load size to 1/3 of a normal load. – Woolen items will be fluffed for a short time, but not completely dried. – Remove the items immediately after the program end and allow them to air dry.
Options	Buzzer, Gentle (cannot be deselected)
Delicates	
Items	Permanent Press items of cotton, mixed fabrics or synthetics e.g. sweaters, dresses, pants, table cloths, etc.
Note	Reduce the load size: <ul style="list-style-type: none"> – to 1/2 of a normal load without any option selected. – to 1/2 of a normal load with the "Turbo" option selected. – to 1/3 of a normal load with the "Gentle" option selected.
Options	Turbo or Gentle, Buzzer
45 min warm	
Items	<ul style="list-style-type: none"> – Final drying of multi-layer fabrics with unique drying characteristics e.g. jackets, pillows and voluminous textiles. – Drying of single items: beach towels, bathing suits
Tip	Use this program to freshen cotton clothing with warm air. To freshen the items even more, dampen the items before drying or use a dryer sheet.
Note	The laundry basket can be used with this program. When using the laundry basket reduce the load size to 1/2 of a normal load.
Options	Turbo or Gentle, Buzzer
15 min cold	
Items	To air items
Note	The laundry basket can be used with this program. When using the laundry basket reduce the load size to 1/2 of a normal load.
Options	Buzzer

Dryer Care

Cleaning the lint filter

The lint is collected by the lint filter in the door. The lint filter must be cleaned after **every** program.

- Clean the lint filter whenever the "Check Filter/Vent" indicator comes on.

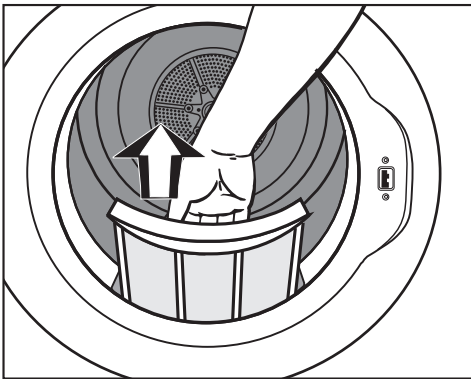

- Pull out the lint filter.

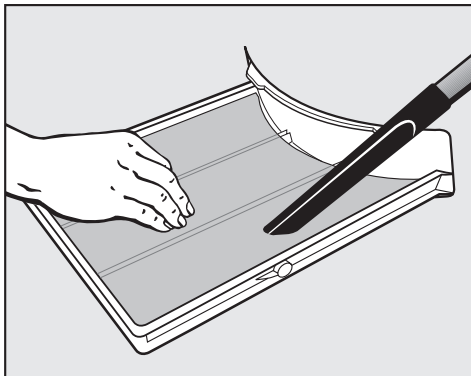

- Wipe the lint off the filter with your hand (do not use any sharp objects!) or use a vacuum cleaner with the supplied vacuum cleaner nozzle.

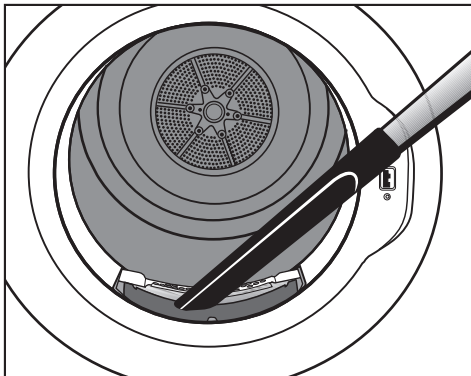

- Clean visible lint from the dryer interior.

 Take care when inserting the lint filter not to hurt your fingers.

- Insert the lint filter with the yellow handle edge facing the drum.

Rinsing the lint filter

- The lint filter can be rinsed with hot water if necessary.
- The filter must be dried thoroughly before being returned to the dryer door.

Cleaning the exterior and the control panel

 To reduce the risk of electric shock, disconnect the dryer from the power supply by shutting off the power main, tripping the circuit breaker or unplugging the power cord before performing maintenance.

Never use abrasive cleaners, scouring pads, steel wool or caustic (oven) cleaners on the dryer. They will damage the surface.

- The exterior, door, control panel and laundry basket can be cleaned with warm water and liquid dish soap applied with a soft sponge.
- Wipe dry using a soft cloth.
- The door gasket can be wiped with a damp cloth.

Stainless steel parts

- Stainless steel surfaces can be cleaned using a non-abrasive stainless steel cleaner.
- Wipe clean with a soft cloth.

Dryer Care

Changing the light bulb

To reduce the risk of electric shock, disconnect the appliance from the power supply by unplugging or tripping the circuit breaker.

- Open the door.

The lighting is in the drum opening in the upper right-hand corner.

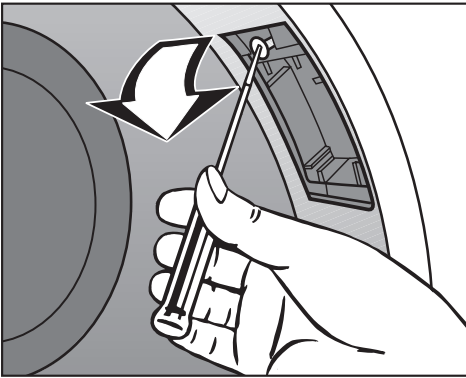

- Remove the screw.
- Flip the cover down.

- Replace the light bulb with a temperature proof bulb available from Miele.

The light bulb must not exceed the maximum wattage quoted on the data plate and the light cover.

- Flip the cover up.
- Tighten the screw.

⚠ Make sure the bulb cover is securely closed to prevent a short circuit or penetrating moisture. Penetrating moisture can cause a short circuit.

Frequently asked questions

 Repairs to electrical appliances must only be carried out by a qualified and trained person in accordance with local and national safety regulations. Repairs and other work by unqualified persons could be dangerous. The manufacturer cannot be held responsible for unauthorized work.

The following section will help you avoid placing a service call by identifying issues you may encounter while operating the machine:

General problems

A drying program cannot be started

Possible fault	Fix
The "Start/Stop" button was not pressed.	Make sure the dryer is on. Press the "Start/Stop" button to begin the drying program.
The circuit breaker has tripped or the dryer is unplugged.	Make sure the dryer is plugged in or reset the circuit breaker.
The door is not closed.	Close the door properly.

The items dried have static cling

Add fabric softener to laundry when washing.

Frequently asked questions

The laundry is not dry enough.	
Possible fault	Solution
The load contained too many dissimilar items (size and fabrics.)	<ul style="list-style-type: none"> – Continue drying using the "Warm air" program. – Select a suitable program.
The laundry is still wet. The program runs too long.	
The gas supply is insufficient.	Check if the gas shut-off valve is closed.
The drum light does not come on.	
The light turns off automatically (energy saving).	Close and open the door, the light should come on.
The bulb may be bad or burned out.	Change the light bulb. See "Dryer Care".
The program runs too long or stops.	
Important: To fix the following problems, open and close the dryer door.	
The air supply is insufficient.	Open a window or door to increase air flow.
The lint filter is clogged with lint.	Clean the lint filter.
The exhaust hose or the connection is clogged with lint.	<ul style="list-style-type: none"> – Check the exhaust parts (e.g. wall vent duct, louvered wall vent, bends, etc.) regularly for air permeability. – Remove the lint.
The laundry was not spun sufficiently in the washer.	Spin laundry thoroughly before drying.
The dryer is over loaded.	Regard the maximum load size per program.
Metallic zippers prevent a correct measurement of the laundry's residual moisture.	<ul style="list-style-type: none"> – Open the zippers of the laundry before drying. <p>If the problem persists, dry items with long zippers using the "45 min. warm" program, if necessary use the laundry basket.</p>

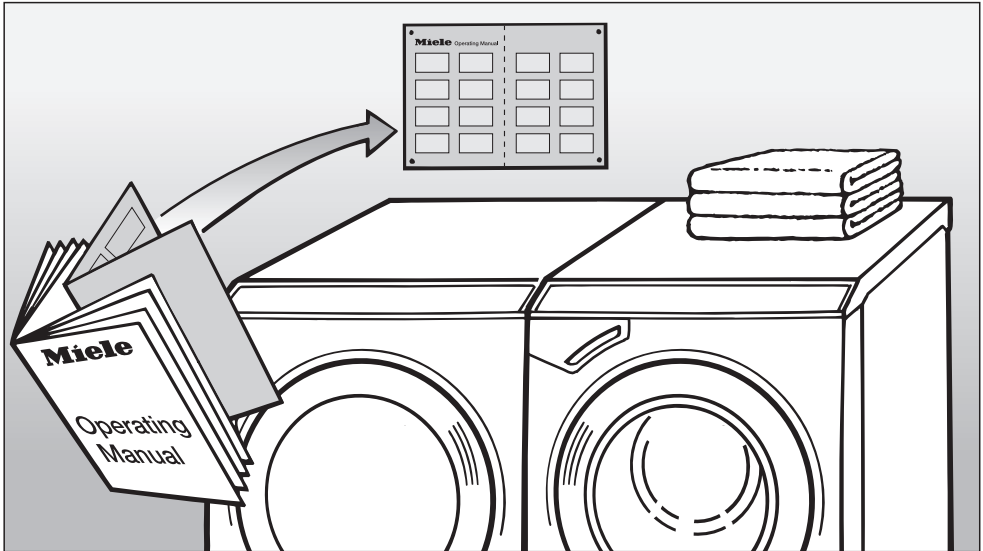

Quick Guide

Remove this guide for easy reference

To prevent accidents
and machine damage
read these instructions
before
installation or use.

Quick Guide

1. Prepare and sort the laundry

- Check for damages and foreign objects.
- Close zippers, hooks and eyelets.
- Tie up belts and apron ties.

2. Load the laundry

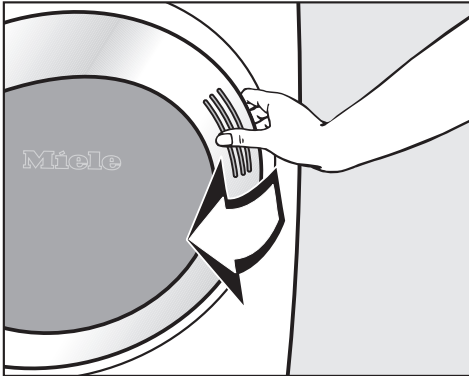

- Open the door.

Without the laundry basket

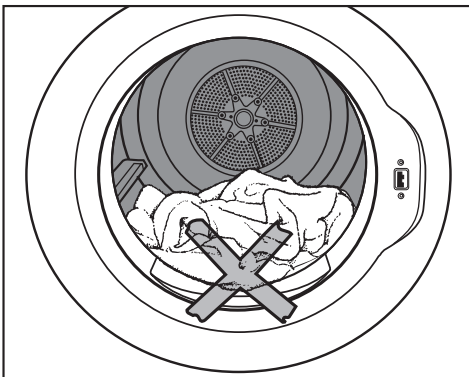

- Load the laundry loosely in the drum.

 To prevent fabric damage, check that laundry will not be caught in the closed door.

With the laundry basket

Reduce the load size to $\frac{1}{2}$ of a normal load.

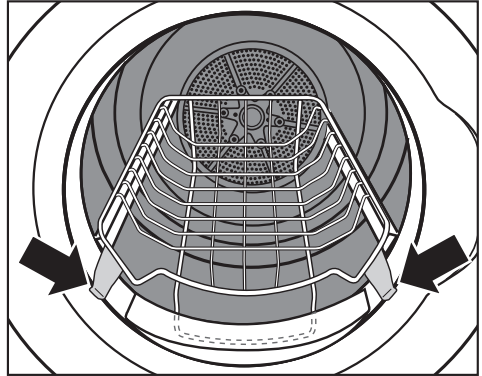

Drying with the laundry basket is only possible in the programs "45 min warm" and "15 min cold".

- Hang the laundry basket in the opening.
- Close the door.

3. Select a program

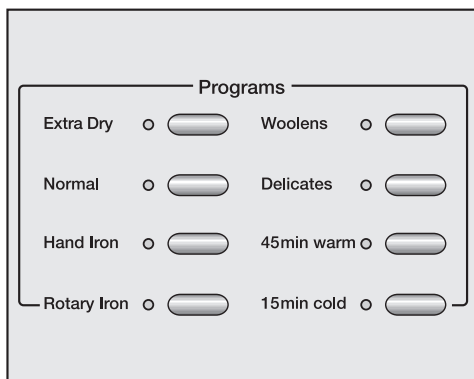

- Press the desired program button.

4. Select an option

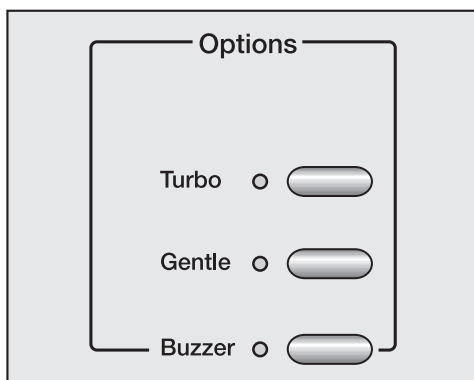

- Select an option button, if desired.

The combination "Turbo/Gentle" is not possible.

5. Starting a program

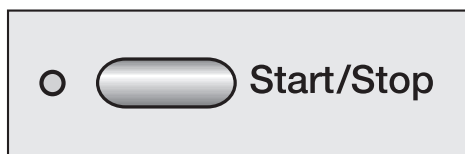

- Press the "Start/Stop" button.

6. Program end - Unload the laundry

The Anti-crease/End indicator lights.

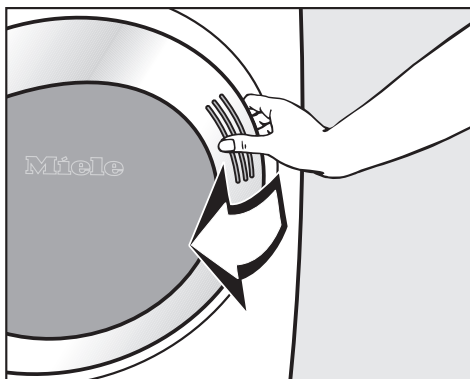

- Open the door.

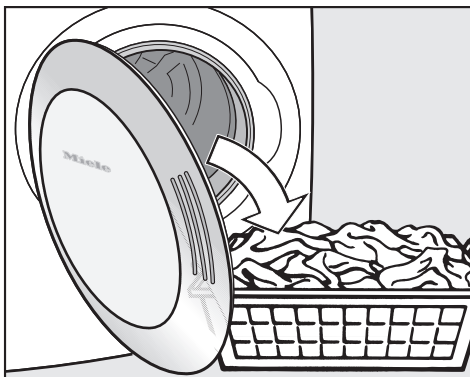

- Remove the laundry/laundry basket.
- Clean the lint filter.
- Close the door.

Quick Guide

Short program guide

Extra Dry

Multi-layer, mixed loads of sturdy cottons, e.g. towels, bath robes.

The "Extra dry" program should not be selected for jersey materials. Items may shrink.

Options: Turbo or Gentle, Buzzer

Normal

Single and multilayered cotton and linen laundry e.g. terry towels, beach towels, bath robes, T-Shirts, underwear, cottons, bed linens, baby clothing.

Options: Turbo or Gentle, Buzzer

Hand iron / Rotary iron

Cotton or linen fabrics to be left damp for easier ironing. e.g. table cloths, bed linens, starched laundry.

Roll up items until they are ironed to keep them damp.

Options: Turbo, Buzzer

Woolens

Woolen items which allow machine drying.

Load size: Reduce the load size to 1/3 of a normal load.

Options: Buzzer, Gentle (cannot be deselected)

Delicates

Permanent Press items made of cotton, mixed fabrics or synthetics e.g. Sweaters, dresses, pants, table cloths.

Load size: Reduce the load size

- to 1/2 of a normal load without any option selected.
- to 1/2 of a normal load with the "Turbo" option selected.
- to 1/3 of a normal load with the "Gentle" option selected.

Options: Turbo or Gentle, Buzzer

45 min warm

Final drying of multi-layer fabrics, with unique drying characteristics e.g. jackets, pillows and voluminous textiles.

Drying of single items: beach towels, bathing suits, etc.

Airing articles

Load size: When using the laundry basket reduce the load size to 1/2 of a normal load.

Options: Turbo or Gentle, Buzzer

15 min cold

Airing or fluffing articles

Load size: When using the laundry basket reduce the load size to 1/2 of a normal load.

Options: Buzzer

Frequently asked questions

Fault indicators

The "Check Filter/Vent" indicator lights.

Possible fault	Solution
The dryer does not work at its optimum or not efficiently. The lint filter might be clogged with lint or detergent residues.	<ul style="list-style-type: none">– Usually cleaning the lint filter fixes the problem. If the problem persists, check all possibilities as described under "The program runs too long or stops".– Open and close the door to turn off the indicator.
The exhaust duct may be too long. This is not a fault.	With a long exhaust duct, program times and energy consumption increase. See Installation Instructions.

A program is canceled.

The "Check Filter/Vent" indicator flashes.

The fault cannot be detected immediately.	<ul style="list-style-type: none">– Check the possible faults as described above.– Open and close the door to turn off the indicator.– Start a program. If the problem persists call Technical Service.
---	---

Frequently asked questions

**The program is canceled.
The Anti-crease/End indicator lights.
The buzzer sounds.**

Possible fault

This is not a fault.
The electronic has detected that there is no laundry in the drum and cancels the program.
Single items or already dried laundry can also cause a program stop.

Solution

- The indicator goes out by opening and closing the door.
- Single items should be dried with the "45 min. warm" program, if necessary use the laundry basket.

**The program is canceled.
The "Rotary iron" or "Hand iron" indicator flashes.
The buzzer sounds.**

The fault cannot be detected immediately.

- The indicator goes out by opening and closing the door.
 - Start a program.
- If the problem persists call Technical Service.

Repairs

In the event of a fault which you cannot fix yourself, please contact the service number on the back of this manual.

When contacting Technical Service, please quote the model and serial number of your appliance. These can be found on the data plate.

Optional accessories

Optional accessories can be obtained by contacting Miele.

MieleCare

(only US)

MieleCare, our Extended Service Contract program; gives you the assurance of knowing that your appliance investment is covered by 5 years of worry free ownership.

MieleCare is the only Extended Service Contract in the industry that guarantees repairs by a Miele Authorized Service Provider using genuine Miele parts. Only genuine Miele parts installed by factory trained professionals can guarantee the safety, reliability and longevity of your Miele appliance.

Please note that unless expressly approved in writing by the Miele Service department, Extended Service Contracts offered by other providers for Miele products will not be recognized by Miele. Our goal is to prevent unauthorized (and untrained) service personnel from working on your Miele products, possibly doing further damage to them, you and/or your home.

To learn more about **MieleCare** Extended Service Contracts, please contact your appliance dealer or visit us online at:

www.store.miele.com

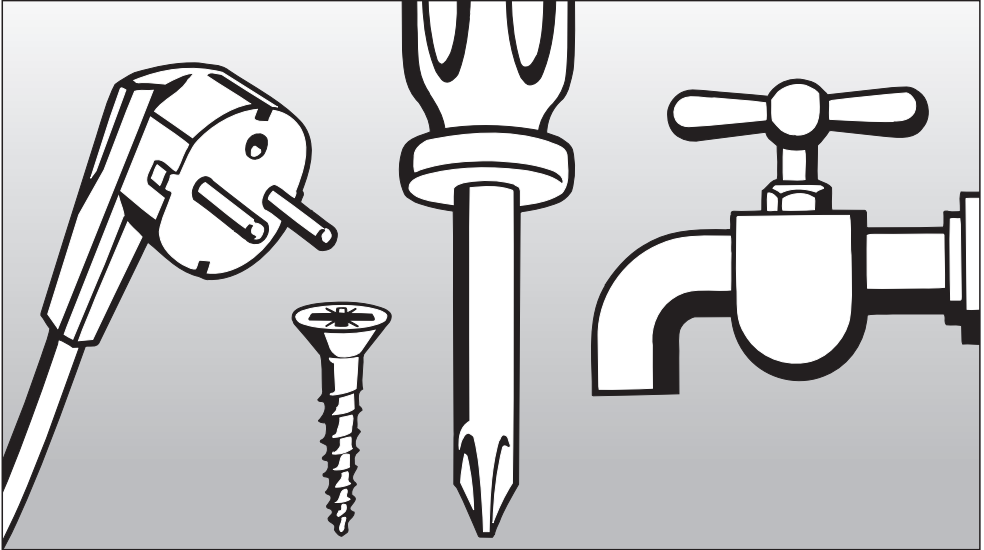

Installation Instructions

To prevent accidents
and machine damage
read these instructions
before
installation or use.

IMPORTANT SAFETY INSTRUCTIONS

■ Installation, repair and maintenance work should be performed by a Miele authorized service technician. Work by unqualified persons could be dangerous and could void the warranty.

■ Before installation, disconnect the tumble dryer from the electrical supply by shutting off the power main, unplugging the power cord or tripping the circuit breaker. Do not restore power until the installation is complete.

GROUNDING INSTRUCTIONS

■ This appliance must be grounded. In the event of malfunction or breakdown, grounding will reduce the risk of electric shock by providing a path of least resistance for electric current. This appliance is equipped with a cord having an equipment grounding conductor and a grounding plug. Only place the plug in an appropriate outlet that is properly installed and grounded in accordance with all local codes and ordinances.

■ **WARNING** – Improper connection of the equipment grounding conductor can result in a risk of electric shock. Check with a qualified electrician if you are in doubt as to whether the appliance is properly grounded.

■ Do not modify the plug provided with the appliance! If it will not fit the outlet, have a proper outlet installed by a qualified electrician.

■ Do not use an extension cord to connect this appliance to the power supply. Extension cords do not guarantee the required safety of the appliance (e.g. danger of overheating).

■ This dryer must be vented outdoors to reduce the risk of fire. Be sure to observe local building codes.

■ Use flexible or rigid metal pipe for venting. Non-metallic flexible hose should not be used, it is a potential fire hazard.

■ The dryer exhaust must not be connected to a chimney, fireplace ducting, a combustion appliance vent flue, a wall, ceiling or concealed space of a building.

■ The installation of this unit in non stationary locations (e.g. ships) must be performed by a qualified installer or service agency, in strict accordance with national and local safety regulations and standards.

■ Do not install the machine in rooms where temperatures below freezing may occur.

■ If there is any doubt concerning installation, contact Miele's Technical Service Department.



1-800-999-1360
techserv@mieleusa.com



1-800-565-6435
service@miele.ca

Front view

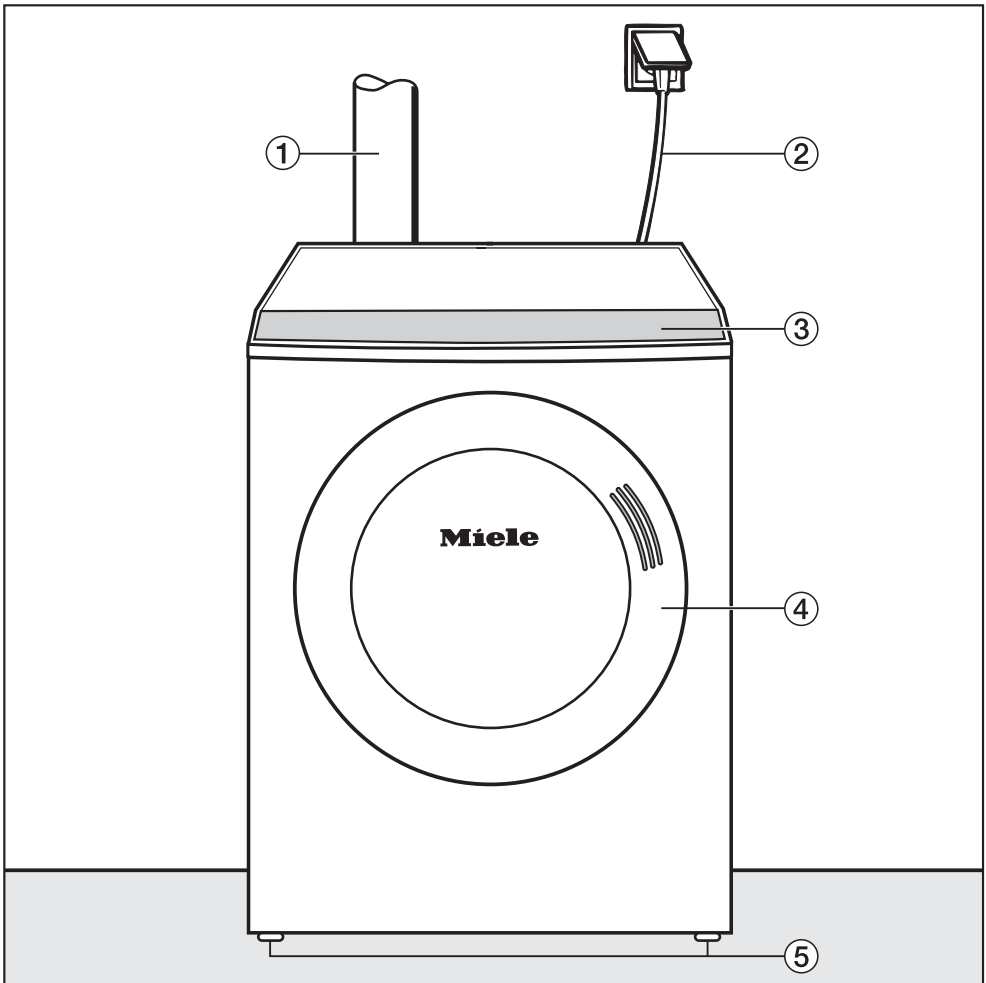

- ① Exhaust connection
- ② Power cord with plug
- ③ Control panel
- ④ Door
- ⑤ Four height adjustable screw feet

Stand

A dryer stand, with drawer, can be purchased as an optional accessory.

Installation

Rear view

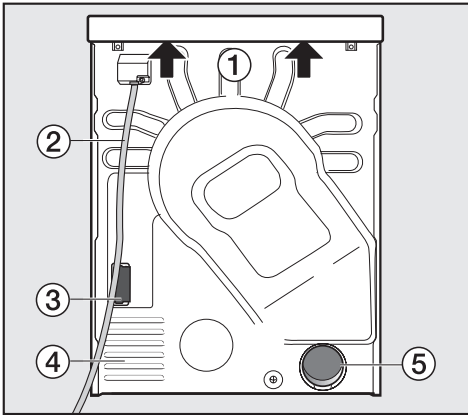

- ① Handle for transportation (arrows)
- ② Power cord with plug
- ③ Shaft for module
- ④ Air intake
- ⑤ Vent connection

Stand

A stand with a drawer can be purchased as an optional accessory.

Installation site

⚠ Do not install the dryer in a location where its door could conflict with room doors.

⚠ The dryer lid cannot be removed.

⚠ The dryer must not be built under a countertop.

Transporting the dryer to the installation site

The rear excess end of the lid has a handle for transport.

- Use the front dryer feet and the rear excess end to transport the dryer from the packaging base to the installation site.

Level the dryer

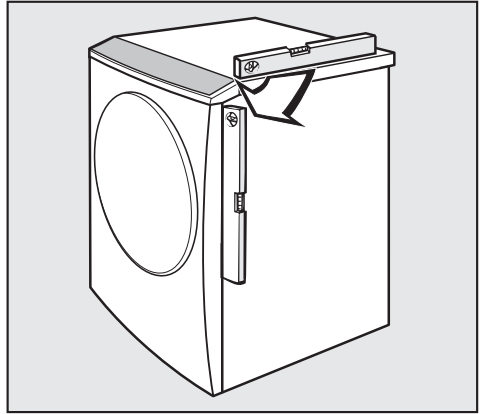

The dryer must be level to ensure safe and proper operation.

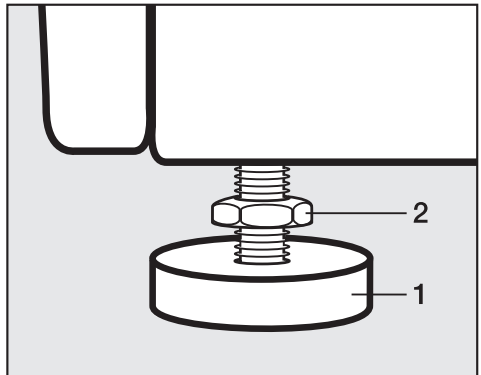

- Unscrew the four feet as much as necessary by turning the foot, **1**, as well as the locking ring, **2**, to the left.
- Once level, hold the foot, **1**, still with a wrench. At the same time turn the locking ring, **2**, to the right using another wrench.

Installation

Electrical connection

GROUNDING INSTRUCTIONS

This appliance must be grounded. In the event of malfunction or breakdown, grounding will reduce the risk of electric shock by providing a path of least resistance for electric current. This appliance is equipped with a cord having an equipment grounding conductor and a grounding plug. Only insert the plug in an appropriate outlet that is properly installed and grounded in accordance with all local codes and ordinances.

WARNING – Improper connection of the equipment grounding conductor can result in a risk of electric shock. Check with a qualified electrician, service representative or personnel if you are in doubt as to whether the appliance is properly grounded.

Do not modify the plug provided with the appliance! If it will not fit the outlet, have a proper outlet installed by a qualified electrician.

The dryer is supplied with a 5 ft. (1.5 m) 4x10 AWG cord and a NEMA 14-30 P plug, ready for connection to a 120/240 (208) V, 60 Hz, 30 A AC power supply.

■ Plug the machine into a proper outlet.

If the plug does not fit, have a proper outlet installed by a qualified electrician.

Installation tips

An airflow gap of $\frac{3}{8}$ " (10 mm) must be provided between the machine and the floor. This airflow gap must not be blocked by a toekick or thick piled carpets.

Sufficient venting of the installation site, e.g. by opening a window or door, is essential for the dryer's operation. Otherwise the drying time and energy usage increases.

Do not install the dryer next to a refrigerator. The warm air exhausting from the dryer can affect the thermostat of the refrigerator, causing it to run continuously.

Installation

How to calculate the effective duct length

The overall duct length will determine the duct diameter.

■ Measure the actual duct length needed to go from the dryer's exhaust connection to the vent outlet:

1. Establish the number of elbows or bends necessary, noting the type of bend, angle and radius involved (see Table).
2. Add the additional duct length (as derived by using the values specified in the table) to the actual duct length to get the effective length.

Note:

Maximum effective duct lengths:

4" (100 mm) diameter	66 ft (20 m)
5" (125 mm) diameter	131 ft (40 m)
6" (150 mm) diameter	328 ft (100 m)

Effective duct lengths over 66 ft (20 m) require a larger duct diameter.

Longer ducts may lead to slight decreases in dryer efficiency if the necessary duct diameter is not followed.

Tips about the ductwork

- Check with your local building code to determine the maximum allowable duct length.
- Use flexible metal pipe or rigid metal pipe for venting. Non-metallic flexible hose should not be used since it is a potential fire hazard.
- For best drying results avoid extra long ducting with too many bends, angles or tight corners.
- The shorter the exhaust ductwork, the more efficient the dryer will be. Expelled air is slowed down in the ducts due to friction against the inner walls. The shorter and smoother the inner walls are, the less friction that will be created.
- An elbow or bend creates more friction than a straight duct. An additional duct length factor must be added for each elbow or bend (see Table). This factor expresses the resistance of the bend in terms of a straight length of duct. The additional length factor is then added to the existing duct to give the effective duct length. A larger duct diameter helps to reduce friction. Therefore the duct diameter and length should be increased simultaneously.

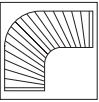
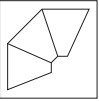
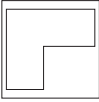
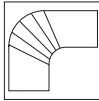
Additional duct lengths (4" (100 mm)rigid pipe only)				
Type of bend	Radius		Additional duct length	
	ft	cm	ft	cm
Flexible metal duct – 3' 3" (1 m) straight – 45° angle – 90° angle 			5' 11"	180
	10"	25	4' 11"	150
	10"	25	8' 2"	250
Smooth metal duct – 3' 3" (1 m) straight – 45° angle – 90° angle 			3' 3"	100
	10"	25	1' 11"	60
	10"	25	2' 7"	80
Elbow 90° sharp 			7' 6"	230
Concertina bend – 90° angle 	8"	20	2' 4"	70
Wall vent or window vent – with louvers – with flap			12' 5"	380
			4' 11"	150
Exhaust connection – left or right side			3' 3"	100

Installation

Example

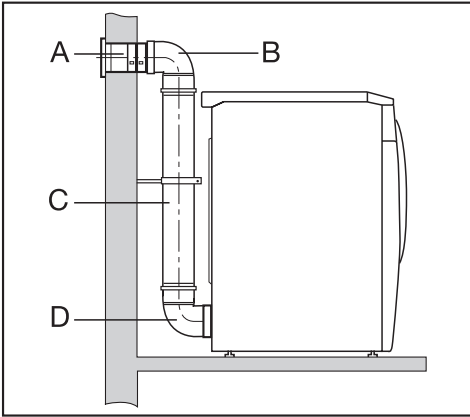

Rigid pipe		Duct length ft	Duct length m
A	Wall duct with louvered wall vent	12' 5"	3.8 m
B	90° bend	2' 4"	0.7 m
C	20" (0.5 m) rigid pipe	1' 7"	0.5 m
D	90° bend	2' 4"	0.7 m
Total duct length		18' 8"	5.7 m

The total duct length is less than 33 feet (10 m), so a duct diameter of 4" (100 mm) with adapter is sufficient.

Exhaust connection with a flexible exhaust hose or rigid pipe

Using the connector supplied, an exhaust hose (4" [100 mm] diameter) can be installed.

Necessary materials:

- a wall or window duct (available from Miele)
- an exhaust hose made of approved non-flammable material

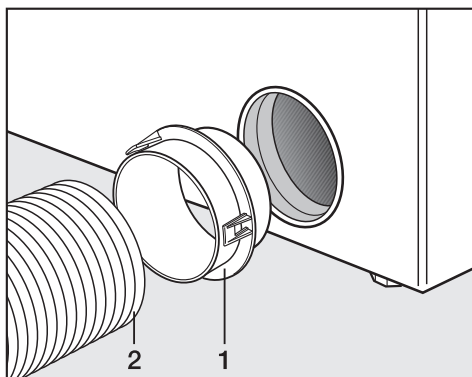

- Install the required connector*, 1, with the exhaust hose or pipe, 2, to the dryer.

* The white connector with clips is used for connection to a hose; the gray connector without clips is used for connection to a pipe.

The exhaust duct must not be connected or secured with screws or other fastening devices which extend into the interior of the duct.

Window connection

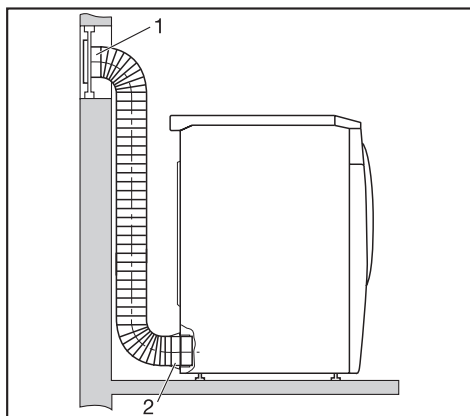

- 1 Window duct (installed in a plexiglass pane)
- 2 Connector for the metallic flexible exhaust hose

Wall connection with rigid pipe

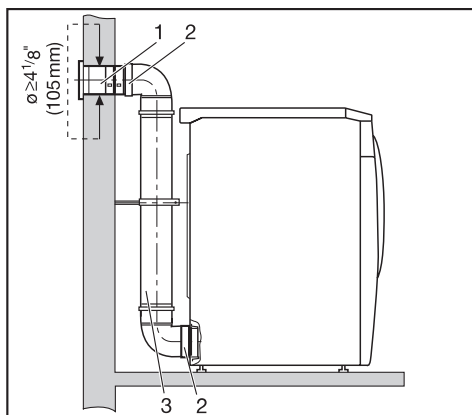

- 1 Wall pipe (Installation sheet supplied with the Miele wall pipe)
- 2 Connector
- 3 Rigid pipe

Installation

Direct wall connection

Necessary materials:

- a wall pipe
- flexible foam gasket

Dryer top view

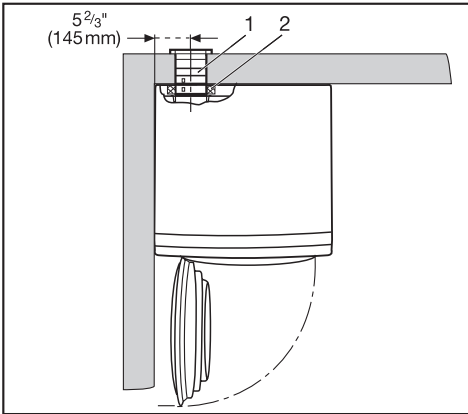

- 1 Wall pipe
- 2 Flexible foam gasket

Dryer side view

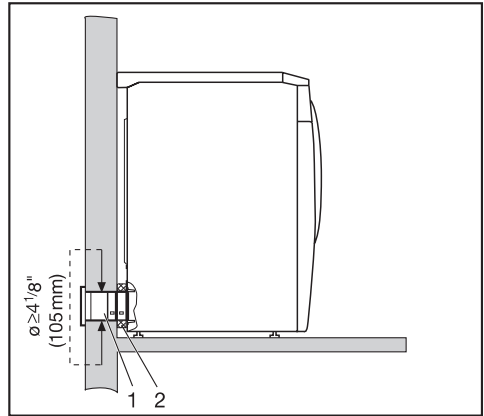

- 1 Wall pipe
- 2 Flexible foam gasket

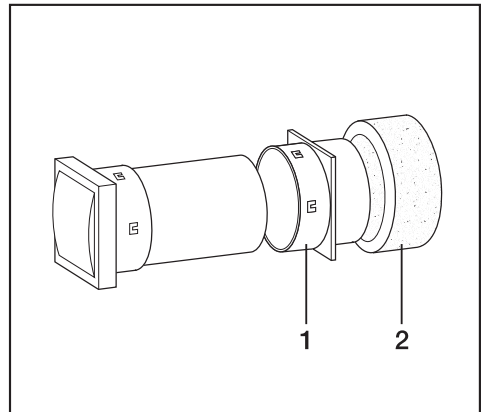

- Connect the flexible foam gasket, **2**, to the wall pipe connector, **1**.
- Push the dryer to the wall.

Disposal of the packing materials

The packing materials protect the appliance during shipping. They have been designed to be biodegradable and recyclable.

To prevent suffocation, ensure that any plastic wrappings, bags, etc. are disposed of safely and kept out of the reach of children.

Disposal of an appliance

Old appliances may contain materials that can be recycled. Please contact your local recycling authority about the possibility of recycling these materials.

Ensure that a discarded dryer presents no danger to children. When being stored for disposal remove the door to the drying compartment.

When contacting the Technical Service,
please quote the model and serial number
of your appliance.



Miele, Inc. (USA)

National Headquarters

9 Independence Way
Princeton, NJ 08540
Phone: 800-843-7231
609-419-9898
Fax: 609-419-4298
www.miele.com

**Technical Service & Support
Nationwide**

Phone: 800-999-1360
Fax: 888-586-8056

Miele Limited (CDN)

Headquarters and Showroom

161 Four Valley Drive
Vaughan, ON L4K 4V8
Phone: 800-643-5381
905-660-9936
Fax: 905-532-2290
www.miele.ca
info@miele.ca (general enquiries)
professional@miele.ca (commercial enquiries)

MieleCare National Service

Phone: 800-565-6435
905-532-2272
Fax: 905-532-2292
service@miele.ca (technical enquiries)