

T30IR901SP

30-INCH BUILT-IN FRESH FOOD COLUMN

FREEDOM® COLLECTION, PANEL-READY



FEATURES & BENEFITS

- Freedom® Hinge enables true flush design
- The new Auto Door Opening provides the opening of the door with just a slight push or pull
- Delicate Produce Bins for expanded storage
- ThermaFresh System, Humidity and Temperature controlled drawers
- SoftClose® Drawers and Produce Bins for easy and controlled storage
- Sleek clean design for the perfect symmetry when paired with additional columns
- TFT control panel managing all your columns functions

TEMPERATURE RANGES

Refrigerator	36°F (2°C) to 46°F (8°C)
Temperature Controlled Drawer	32°F (0°C) to 46°F (8°C)
Deli Drawer	Just above 32°F (0°C)
SuperCool	35.5°F (2°C) for approximately 6 hours
Energy Saving (Economy) Mode	45°F (7°C)

GENERAL PROPERTIES

Home Connect™ (Wi-Fi Enabled)	Yes
Panel Ready	Yes
Reversible Door Swing	Yes
SoftClose® Drawers	Yes
Carbon Air Filter	Yes
Lighting	Bar ALL LED Sidewall and Theater Lighting
Full Width Shelves	4
Adjustable Shelves	3
Shelf Material	Glass w/Aluminum Profile
Full Extension Drawers @ 115° Door Opening Angle	Yes
Full Extension Drawers @ 90° Door Opening Angle	Yes
Temperature and Humidity Controlled Drawer	1
General Use Drawer	1
Door Bins	2
Gallon Door Bins	1
Delicate Produce Bins	2 Large
Door Open Alarm	Yes
Open Door Assist	Yes
Special Modes	Sabbath, Economy, Vacation

CAPACITY

Total Capacity (cu. ft.)	16.8 cu. ft.
--------------------------	--------------

PERFORMANCE

Dedicated Evaporator & Compressor System	Yes
Freeflow® Cold Air System	Yes
SuperCool	Yes

TECHNICAL DETAILS

Watts (W)	350 W
Current (A)	15 A
Volts (V)	120V-3 Prong
Frequency (Hz)	60 Hz
Power Cord Length (in.)	139
Plug Type	120V-3 Prong

DIMENSIONS & WEIGHT

Appliance Dimensions (H x W x D) (in.)	83 3/4"* x 29 3/4" x 24"
Required Cutout Size (H x W x D) (in.)	84" x 30" x 25"
Net / Gross Weight (lbs)	344 / 368 lbs

EFFICIENCY

ENERGY STAR® Qualified	Yes
Annual Energy Consumption	289 kWh

*Height adjustable + / -1/2" (+ / -13 mm)

T30IR901SP

30-INCH BUILT-IN FRESH FOOD COLUMN

FREEDOM® COLLECTION, PANEL-READY



WARRANTY

Limited, Entire Appliance, Parts and Labor on Any Part of the Refrigerator that Fails Because of a Manufacturing Defect	2 Year
Limited Warranty for Sealed Refrigeration System**; Parts and Labor	3rd to 6th Year
Limited Warranty for Sealed Refrigeration System**; Parts Only	7th to 12th Year
Limited Warranty for Stainless Steel Rust-Through	Lifetime

**Sealed refrigeration system includes compressor, evaporator, condenser, dryer / strainer and connection tubing

CUTOUT DIMENSIONS

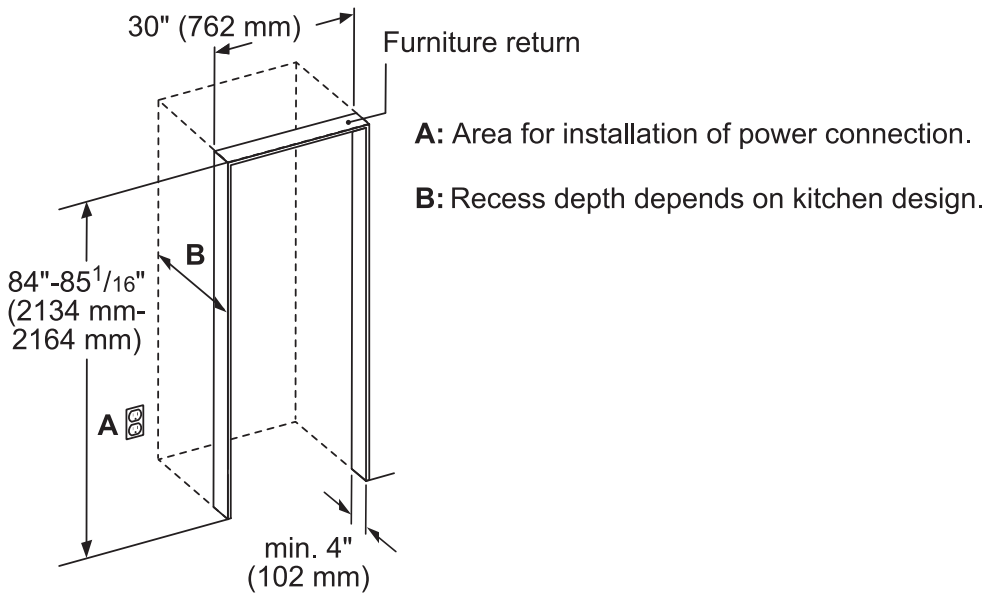

TOP VIEW CLEARANCE

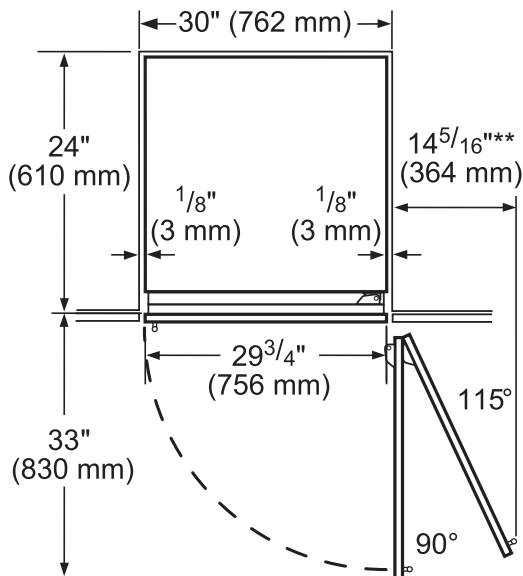

** Door handle must be added to this dimension

* Depends on the thickness of the furniture door. 3/4" (19 mm) is relevant for the stainless steel door. (special Accessory).

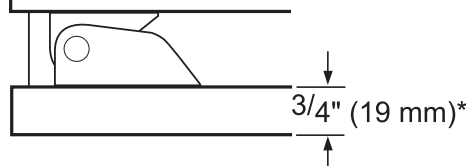

T30IR901SP

30-INCH BUILT-IN FRESH FOOD COLUMN

FREEDOM® COLLECTION, PANEL-READY



PRODUCT AND PANEL DIMENSIONS

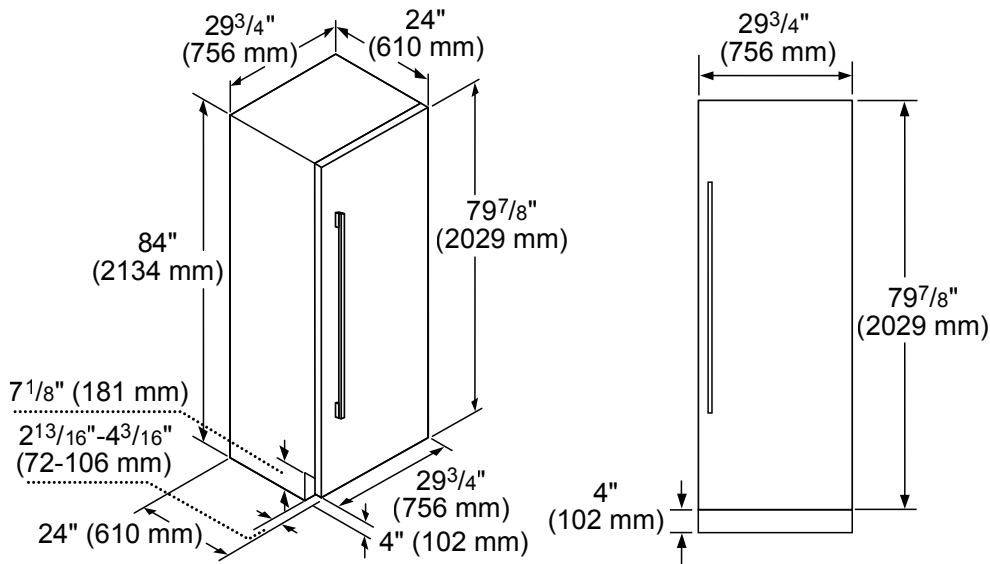

ACCESSORIES (OPTIONAL)

FLAT STAINLESS STEEL DOOR PANELS



TFL30IR800
30-Inch Flat Stainless Steel Door Panel

NOTE: Handleless Panels should not be installed on units without the Soft-Close capability. If you are uncertain if you have a refrigeration unit with Soft-Close capability please contact our customer team by calling 1-800-735-4328.

STORAGE



SPRODBIN10
Small Produce Bin



LPRODBIN10
Large Produce Bin



30PRODRAIL
30-Inch Produce Railing



30HFGALBIN
30-Inch Half Gallon Bin

HANDLES

NOTE: Choose one handle for each column, choose 2 handles for each 2-door bottom freezer and choose 3 handles for each French Door bottom freezer.



PR36HNDL20
36-Inch Professional Series Handle
PR30HNDL20
30-Inch Professional Series Handle



MS36HNDL20
36-Inch Masterpiece® Series Handle
MS30HNDL20
30-Inch Masterpiece® Series Handle

AVAILABLE WHILE SUPPLIES LAST:

MS36HNDL10
36-Inch Masterpiece® Series Classic Handle
MS30HNDL10
30-Inch Masterpiece® Series Classic Handle

HEATRKIT20 – 13W @ 120V

Freedom® Heater Kit

When two appliances are installed side-by-side a sealing kit must be used. For combinations that involve a freezer column, this kit is included. For all other (non-traditional, i.e. two wine columns, two bottom freezers, etc.) side-by-side combinations or instances where any appliances are installed less than 6-inches (152 mm) apart from one another but not connected side-by-side, purchase this kit. This kit is recommended for use with any installation in areas that are subject to humidity, or located next to an outside wall.

These warranties give you specific legal rights and you may have other rights that vary from state to state. Full warranty and limited warranty from date of installation. For complete warranty details, refer to your Use & Care manual, or ask your dealer.

Specifications are for planning purposes only. Refer to installation instructions and consult your countertop supplier prior to making counter opening. Consult with a heating and ventilation engineer for your specific ventilation requirements. For the most detailed information, refer to installation instructions accompanying product or write to Thermador indicating the model number. Specifications are correct at time of printing. Thermador reserves the right to change product specifications or design without notice. Some models are certified for use in Canada. Thermador is not responsible for products that are transported from the U.S. for use in Canada.