

SPR36UIMMW

Range size	36"
Oven energy source	Electricity
Cooktop type	Induction
Main oven	Thermo-ventilated
Cleaning system - Main oven	VaporClean
EAN code	8017709347772



Aesthetic











Series	Professional	Slider	Red
Design	Squared design	Control knobs	Pro-style control knobs
Color	Matte white	Controls color	Stainless steel
Front panel color	Matt white	No. of controls	7
Control panel finish	Stainless steel	Silkscreen color	Black
Logo	Assembled	Display	Touch
Logo position	Fascia below the oven	Handle	Robust knurled handle
Cooktop color	Stainless steel	Handle color	Brushed stainless steel
Control setting type	Control knobs		

Programs / Functions

No. of cooking functions 8

Traditional cooking functions

 Static	 Fan-assisted	 True European convection
 Small grill	 Large grill	 Large grill + Fan
 Convection bottom	 Pizza	

Other functions

 Defrost by time
--

Cleaning functions



Cooktop options



End cooking timer	5
Minute minder	1

Multizone Option Yes

Cooktop technical features



Cooking zones 5

Front-left - 1300 W - Booster 1400 W
 Rear-left - 2300 W - Booster 3000 W
 Center - 2300 W - Booster 3000 W
 Rear-right - 1300 W - Booster 1400 W
 Front-right - 2300 W - Booster 3000 W

Cooking zones with Booster 5

Number of Flexible zones 1

Booster power left Multizone 3700 W

Booster power right Multizone 3700 W

Automatic switch-off in case of over-heating Yes

Automatic switch-off in case of overflow Yes

Automatic pan detection Yes

Minimum pan diameter indicator Yes

Selected zone indicator Yes

Residual heat indicator Yes

Main Oven Technical Features

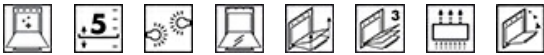

No. of lights 2

Fan number 2

Volume 4.45 cu. ft.

Cavity material EverClean enamel

No. of shelves 5

Shelves type Metal racks

Light type Halogen

Light Power 40 W

Time setting Minute minder

Full-glass inner door Yes

Removable inner door Yes

Total no. of door glasses 3

Cooling system Tangential

Bottom heating element - Power 1700 W

Upper heating element - Power 1200 W

Grill power 1700 W

Large grill - Power 2900 W

Circular heating element - Power 1550 W

Grill type Electric

Soft Close system Yes

Main oven options

Minimum Temperature 151 °F

Maximum temperature 500 °F

Included accessories

Oven wire rack 2

Meat Probe 1

Electrical Connection

Voltage 208/240 V
 Type of electric cable installed Yes, Double phase
 Power cord length 47 1/4 "

Frequency 60 Hz
 Terminal block 3 pins

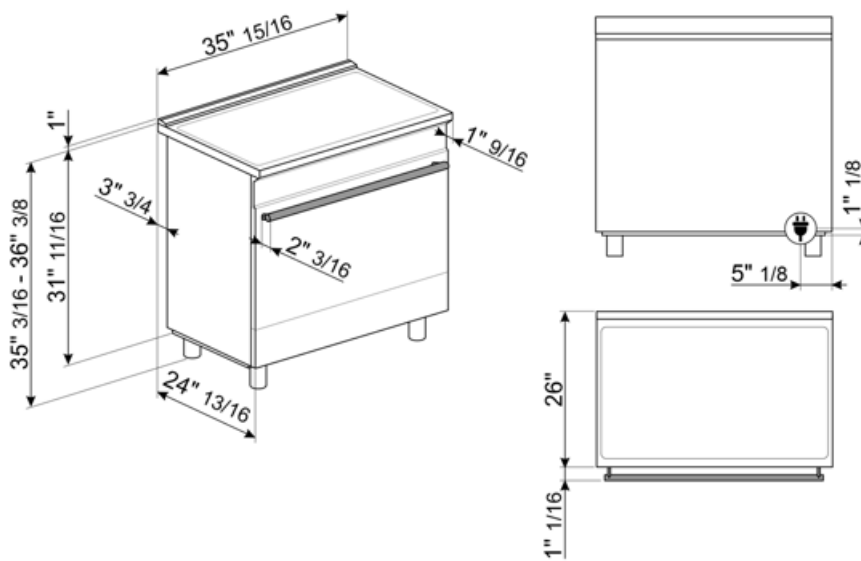

Not included accessories



GRILLPLATE

Universal griddle for induction, gas, ceramic and electric hobs. Non-stick surface ideal for cooking meat, cheese and vegetables. Dimensions: 410 x 240 mm.



KITTKSPR36

Plinth, 3 sides, 900mm , SPR cookers 30", black



PPR9

Refractory pizza stone without handles. Squared stone (HxWxD): 0.9" x 25.2" x 14.75". Also suitable for gas ovens, to be placed on a rack



SFLK1

Child lock



GT3T



PALPZ

Pizza shovel with fold away handle width: 315mm length : 325mm



SCRP



















Induction and ceramic hobs and teppanyaki scraper















TPKPLATE

Universal plate for induction, gas, ceramic and electric hobs. Non-stick surface ideal for cooking fish, eggs and vegetables. Dimensions: 410 X 240 mm.

Symbols glossary

 <p>A: Product drying performance, measured from A+++ to D / G depending on the product family</p>	 <p>Power booster: option allows the zone to work at full power when very intense cooking is necessary.</p>
 <p>Installation in column: Installation in column</p>	 <p>Air cooling system: to ensure a safe surface temperatures.</p>
 <p>Defrost by time: with this function the time of thawing of foods are determined automatically.</p>	 <p>Triple glazed doors: Number of glazed doors.</p>
 <p>Enamel interior: The enamel interior of all Smeg ovens have a special antacid lining which helps keep the interior clean by reducing the amount of cooking grease adhering to it.</p>	 <p>Circogas: In gas ovens the fan distributes the heat quickly and evenly throughout the oven cavity, avoiding flavour transfer when cooking a number of different dishes at the same time. In electric ovens this combination completes cooking more quickly of foods that are ready on the surface, but that require more cooking inside, without further browning.</p>
 <p>Fan with upper and lower elements: The elements combined with the fan aim to provide more uniform heat, a similar method to conventional cooking, so pre-heat is required. Most suitable for items requiring slow cooking methods.</p>	 <p>Upper and lower element only: a traditional cooking method best suited for single items located in the centre of the oven. the top pf the oven will always be hottest. Ideal for roast, fruit cakes, bread etc.</p>
 <p>True European Convection: The combination of the fan and circular heating element around it provides many benefits, including no preheat if cooking time is longer than 20 minutes, no flavor transfer when cooking different foods at the same time, lower energy consumption, and shorter cooking times. Suitable for all types of food preparations.</p>	 <p>Grill element: Using of grill gives excellent results when cooking meat of medium and small portions, especially when combined with a rotisserie (where possible). Also ideal for cooking sausages and bacon.</p>
 <p>Half grill: For rapid cooking and browning of foods. Best results can be obtained by using the top shelf for small items, the lower shelves for larger ones, such as chops or sausages. For half grill heat is generated only at the centre of the element, so is ideal for smaller quantities.</p>	 <p>Fan with grill element: The fan reduces the fierce heat from the grill, providing an excellent method of grilling various foods, chops, steaks, sausages etc. giving even browning and heat distribution, without drying out the food. The top two levels recommended for use, and the lower part of the oven can be used to keep items warm at the same time, an excellent facility when cooking a grilled breakfast. Half grill (centre portion only) is ideal for small quantities of food.</p>
 <p>Pizza function: The simultaneous operation of three elements ensures an optimum cooking facility when used with the Smeg pizza stone.</p>	 <p>Overheat protection: The safety system that automatically turns off the hob in case of overheating of the control unit.</p>
 <p>Induction: The work of these hobs is based on the principle of electromagnetic induction. The heat is generated directly in the bottom of the pan during its contact with the hob.</p>	 <p>All glass inner door: All glass inner door, a single flat surface which is simple to keep clean.</p>

-
- | | | | |
|--|---|---|---|
|  | The inner door glass: can be removed with a few quick movements for cleaning. |  | Side lights: Two opposing side lights increase visibility inside the oven. |
|  | Automatic opening: some models have Automatic opening door when the cycle is finished which is a perfect solution for handle-less kitchen units as no handle is needed. For safety reasons, the door locks automatically when the machine is in use to avoid it being opened inadvertently. |  | Overfill protection: The special overfill protection shuts down the stove in the presence of overflow of liquids. |
|  | Indication of residual heat: After the glass ceramic hob is switched off the residual heat indicator shows which of the heating zones still remains hot. When the temperature drops below 60 ° C, the indicator goes out. |  | The oven cavity has 5 different cooking levels. |
|  | Soft close: all models are equipped with advanced function of smooth closing of the door, which allows the device to close smoothly and quietly. |  | Timer: All ceramic hobs have a timer which automatically ends cooking after a preset time. |
|  | Vapor Clean: a simple cleaning function using steam to loosen deposits in the oven cavity. |  | The capacity indicates the amount of usable space in the oven cavity in litres. |
|  | ... |  | Knobs control |
|  | Automatic merge of zones for a bigger area | | |

Benefit (TT)

Induction hob

Induction offers fast cooking and precise temperature control

Through the use of suitable cookware, induction is easy to use and maintain, safe and responsive

Vapor Clean

By inserting water into a recess at the bottom of the cavity, steam is generated, which softens the residue and facilitates its removal

By inserting water into a recess at the bottom of the cavity, steam is generated, which softens the residue and facilitates its removal.

Touch control

Easy and intuitive timer setting with a single touch

True-convection

The best cooking performances guaranteed by ventilated circular flow.

Multiple fans and heating elements guarantee the perfect aerodynamic heat flow, allowing homogeneous and quicker cooking inside the cavity.

Multilevel cooking

Several cooking levels allow maximum flexibility of use

Multilevel halogen light

Internal halogen lighting on different levels guarantees excellent visibility

Removable inner glass

Internal door glasses are easily removable for complete cleaning

Tangential cooling

New cooling system with tangential fan and airflow from the door to the splashback

Isothermic Cavity

The best cooking performance at the highest energy efficiency

BBQ (optional accessory)

Barbeque cooking directly in the oven with the double-sided grill

Pizza stone (optional accessory)

Baking with refractory stone for soft and crispy pizza and yeast products (STONE optional accessory)

Cold door

During any function, the external door glass is cold, avoiding any risk of burns

AirFry (AIRFRY optional accessory)

Lighter and tastier food thanks to airfry basket

Adjustable height

Cooker top flushed with the working area thanks to adjustable feet

Soft close

The door is equipped with a specific system for silent closing

Double Turbine

The oven has two fans equipped with two circular heating elements allowing cooking with rotating heat