

KBTU36AN



Product family	Hood
Hood Type	Decorative wall hood
Design	T flat
Extraction	Extraction
Electronic control	Yes
Material	Stainless steel
Type of steel	Brushed
EAN code	8017709351533
Hood width	36 "
Aesthetic	Universale
Colour	Anthracite
Logo	Embossed



Controls

Control setting	Touch control back-lighted White
-----------------	-------------------------------------

Program / Functions

No. of speeds	3
Intensive speed	
24h air filter function	
Time-setting options	

Technical Features



No. of lights	2	No. of filters	3
Light type	LED	Anti-grease filters	Aluminium
Light Power	1.3 W	Filter replacement indicator	Yes
Dimmer mode	Yes	Vent outlet	5 7/8 "
Light color temperature scale (°K)	3000 °K	Minimum distance from GAS hob	750 "
Free outlet maximum capacity	553.5 CFM	Minimum distance from ELECTRIC hob	650 "
Motor power	350 W	Non return valve	Yes

--	--	--

Accessories Included

Tube reduction Yes

Performance / Energy Label

Annual Efficiency Consumption (AEChood) 54 KWh/year

Electrical Connection

Plug	(B) NEMA 5-15P	Frequency (Hz)	60 Hz
Voltage	110-127 V	Power supply cable length	1500 "

Also available

Alternative colours available Matt white, Matt Black

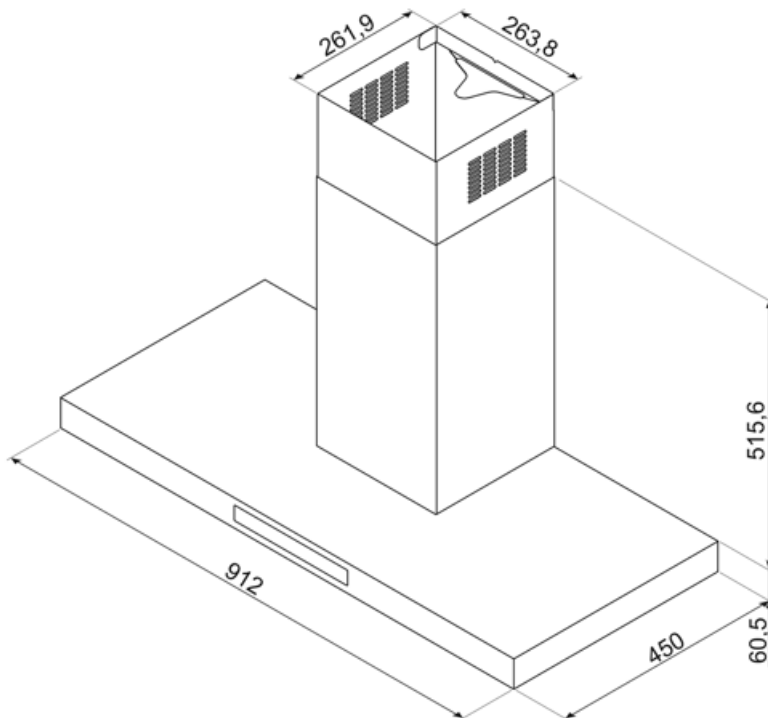

Compatible Accessories

FLT6U



KITCEKBTMB



Alternative products



KBTU36MW







Colour: Stainless steel



KBTU36X

Colour: Stainless steel

Symbols glossary

- | | | | |
|--|---|---|---|
|  | 24h: When selected this function refreshes the air for c. 10 minutes every hour over a 24 hour period, at minimum speed and an imperceptible noise level. |  | Filters: Model has filters to help remove grease from the steam emanating from the pans during cooking. |
|  | Switch off automatically: A special setting, to run after the end of cooking for a pre-set time and then switch off automatically. |  | Warning light(s): to advise when filters need changing. |
|  | Lights: All cooker hoods feature lights to illuminate the cooking area or add to the ambience of the kitchen. |  | Intensive/turbo setting: when extra fast extraction is required. |
|  | Dimmering Lights | | |

Benefit (TT)

Touch display back lighted white

Intuitive and immediate usability thanks to the elegant white LED backlit touch display