

SAPPHIRE

Adapting to Your Environment

Indoor, Outdoor and ADA

Wine Refrigerators | Ice Machines | Beverage Centers | Glass Door Refrigerators | Accessories

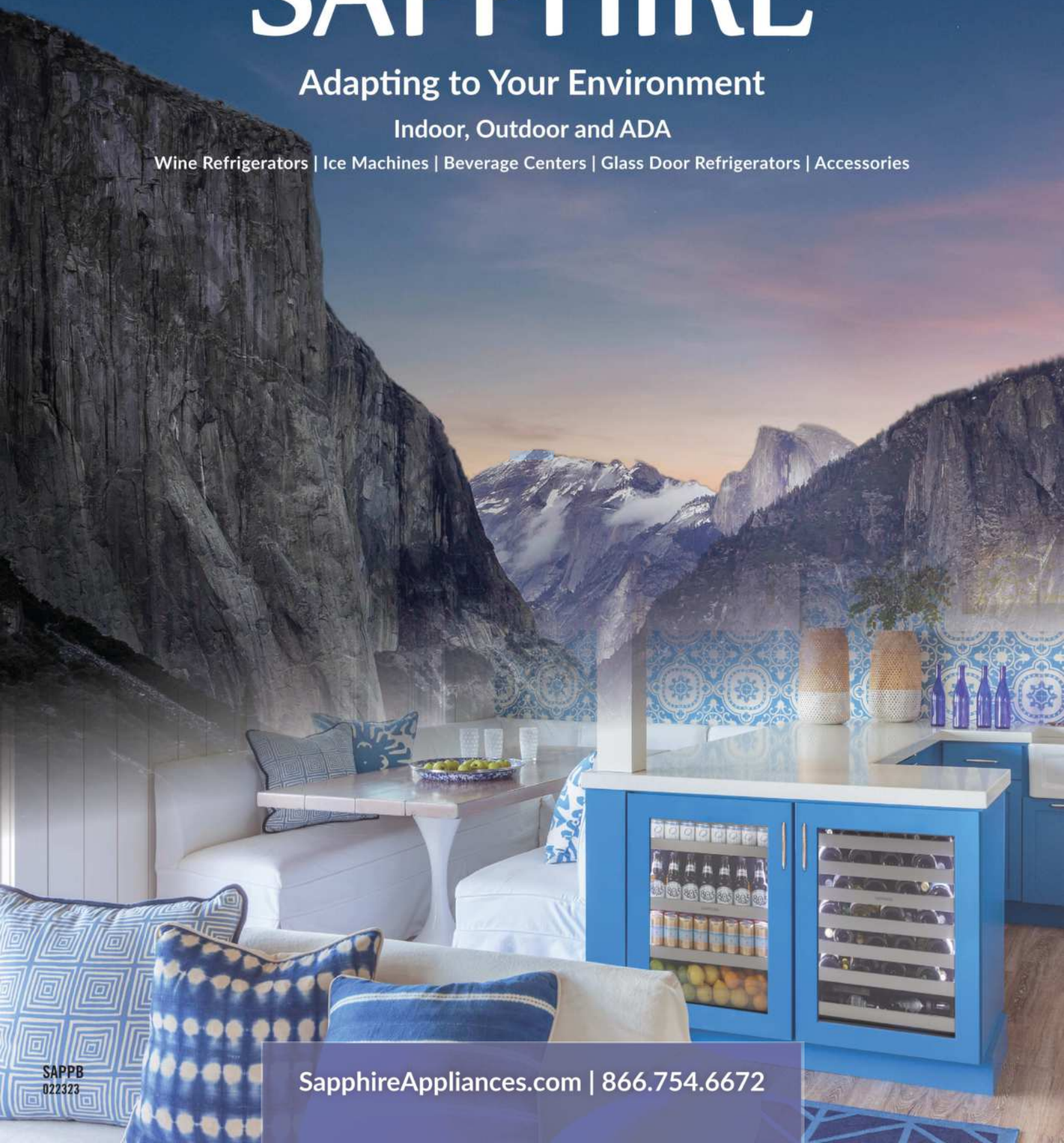

SAPPB
022323

SapphireAppliances.com | 866.754.6672

Table of Contents - Series 5

Superior engineering and designed for luxury, your entertainment is effortless with Sapphire Appliances. Whether indoors or outdoors, Sapphire Appliances keep you cooler faster.

10 Clear Ice Machines



Indoor Gourmet Cube



Indoor Square Cube



Indoor ADA Square Cube



Outdoor Gourmet Cube

20 Wine Refrigerators



Indoor Single Zone



Indoor Single Zone



Indoor Dual Zone

28 Beverage Centers



Indoor Beverage Center



ADA Beverage Center

34 Refrigerators



Indoor Refrigerator



Indoor Refrigerator



ADA Refrigerator



Outdoor Refrigerator

44 Refrigerator Drawers



Indoor Drawer



Outdoor Drawer

50 Accessories



54 Contact Info Warranty



Customer Service: 1.866.754.6672
Service for your Sapphire Appliance:
sapphire@adcoservice.com



Welcome to the World of Sapphire

Discover the latest in innovation and design technology that was developed specifically for you and built to adapt to your environment. Sapphire's complete product line with detailed design, precise integration and unsurpassed performance sets a new standard in built-in undercounter ice-making and cooling products.

Sapphire is the newest addition to The Legacy Companies (TLC) portfolio of residential and commercial brands. TLC, a global leader based in Florida, is beyond equipped to tackle the challenges faced with integrated installation, flexibility and design which had not been resolved. Our development team consisted of five industry leaders from the undercounter ice machines and refrigeration product segment. Our observation was clear: The market doesn't need just "another" undercounter product. Most brands have treated the built-in undercounter segment as a filler to a line of appliances with limited innovation and thought. In many cases, the product is sourced from factories based on what they already produced.

The result: Sapphire. A product that not only exuded beauty and a refined look but also worked seamlessly into any environment and situation. Sapphire was created to be a leader in the industry – not just another brand extension, but a singular line that was entirely focused on what it takes to be the best in the undercounter space. Designing, engineering and manufacturing our product in our own factory!

With all the aspects of development and manufacturing under one roof, the Sapphire family of products works perfectly for the cook, the craft cocktail maker, entertainer and family for installation indoors, outdoors or ADA height applications.

The attention to design detail is evident from top to bottom, inside and out. From the beautiful signature Sapphire blue interior, seamless integration, door and handle design, shelves and bins, elegant lighting, Sapphire's precious elements are unmistakable.

For more stunning details, see each product page for further highlights.



Solving Challenges Through Design:



Space Management:

Wine bottles don't fit in the racks. Or Beverages and food packaging won't fit on the shelves.



Life Changes:

I don't store as much wine anymore. Or I need *more* wine storage! Now I have to buy another unit.



Accessibility:

It's difficult to access product that is lower and further back in the unit. It is so dark inside the unit and difficult to see.



Doesn't Fit Quite Right:

The undercounter unit doesn't seem to fit right with my cabinets. Large gaps, toe kick sticking out into room, unit is protruding from the cabinets. Looked better in the showroom!



Design:

Seems like undercounter products cut corners and compromise on design. They are not as elegant as their larger counterparts. They seem like an after-thought.

Read on to discover how Sapphire addresses these challenges by adapting to your environment.

Space Management. Life Changes. Accessibility.

Accessorize your Sapphire. The ability to manage a variety of wine bottles and can sizes in addition to other storage needs is at the forefront of Sapphire design. Sapphire models have been engineered with cantilevered racking systems and interchangeable inserts, making it easy to adapt for your current food and beverage storage needs as your preferences evolve over time.

With multiple rack locations, the racking system allows you to choose from wine racks, tempered glass shelves and chrome-plated wire shelves if out of the box configurations are not ideal for your current needs. Of course, as your food and beverage demands change, you can adapt your unit with the appropriate racks and insert accessories to fit your new needs.

All racks and shelves are full extension glide-out – making access to your food and beverage items easy and convenient, even if items are hidden in the back. The LED lighting illuminates through the shelves and racks, allowing you to clearly see what is inside.



**SPECIALTY
WINE RACK
INSERT**

750 ml



**STANDARD
WINE RACK
INSERT**

750 ml

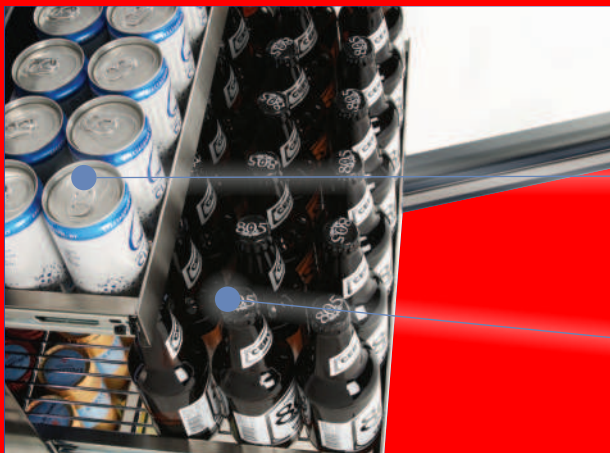

**TEMPERED
GLASS SHELF
INSERT**

**CHROME
WIRED SHELF
INSERT**

Series 5 Makes Entertaining Easy With Sapphire's Superior Performance.

Superior engineering and designed for luxury, your entertainment is effortless with Sapphire Appliances. Whether indoors or outdoors, Sapphire Appliances keep you cooler faster.

EASY-TO-USE ELECTRONIC CONTROL SYSTEM

actively manages your ice-making and refrigeration systems. In addition to normal control functionality, you can easily manage lighting and hours of operation.

UNMATCHED INTEGRATION

complemented by full stainless cabinet/ exterior and articulating hinge provides precise zero-clearance installation.

ADAPTABLE CANTILEVERED RACKING SYSTEM

allows you to choose from multiple locations and interchangeable inserts.

THE LED THEATER LIGHTING

illuminates through the shelves and/or racks, allowing you to clearly see what is inside.

WITH MULTIPLE RACK LOCATIONS,

the racking system allows you to choose from wine racks, tempered glass shelves or/and chrome-plated wire shelves if out of the box configurations are not ideal for your current needs.

ADAPTABLE GRILLE DESIGN

allows meticulous alignment with adjacent cabinetry and the option to design a continuous cabinet toe kick.

TEMPERATURE MANAGEMENT & RECOVERY

provides fast cool down and maintains even temperature. Sapphire's cooling system is engineered with a powerful compressor, twin condenser motor fans, optimized wind route system and vortex technology to achieve fast cool down and even temperature resulting in an extremely energy efficient operation.



The Right Fit.

Sapphire models are sized and engineered to allow precise zero clearance for flush installation for unmatched integration into a standard 24" depth cabinet in any inset, frameless or overlay face-framed style cabinetry. This is accomplished by designing products to the same measurements as cabinet dimensions. Combine articulating hinges, adjustable toe kicks, panel-ready models and you have a product that will precisely and seamlessly install into your cabinets and design lines.

All Sapphire products are panel-ready for your ¾" custom door panel and handle. They include an adaptable grille design which allows meticulous alignment with adjacent cabinetry and the option to design a continuous cabinet toe kick. If a stainless-steel finish is a design requirement, these models will also precisely install within your cabinetry and toe kick, creating their own fashion statement.

Sapphire Panel-Ready products allow for adding a panel or frame of up to 25 lbs. (more than any other competitor).



Fits like a Cabinet, Not an Appliance.

Stainless Steel



Panel Ready



CLEAR ICE MACHINES

The Legacy Companies' decades of commercial and restaurant-style ice machine innovations are now available for the residential marketplace. Sapphire offers two different ice types, producing up to 75 pounds of restaurant-quality clear ice per day, allowing you to choose which ice type fits your lifestyle.





Indoor
Gourmet Cube



Indoor
Square Cube



ADA Height
Square Cube



Outdoor
Gourmet Cube

Indoor | 15" Clear Ice Machine Gourmet Cube: Gravity Drain and Pump Models



- Produces up to 68 lbs of 1½" x 1½" x 1½" clear gourmet cubes per day
- Bin stores up to 25 lbs of clear ice
- Energy Star rated
- Integrated water filter system removes any impurities producing the clearest ice, filter included
- Clear ice scoop and storage hook included
- Signature SAPPHIRE blue interior
- Fully wrapped stainless-steel exterior
- Articulating, concealed self-closing hinges with built-in door stop
- Multifunction capacitive touch electronic control
- Auto shut-off when ice bin is full
- Alert notifies when time to initiate easy cleaning process
- Quiet mode feature can be set to suspend ice-making production during specific times of the day
- Full LED theater lighting
- Unit ships right hinged with field-reversible doors
- Stainless model includes a 1" diameter stainless steel handle with faceted standoffs (26" length)
- Panel ready model requires ¾" custom door panel and handle
- Precise zero clearance design allows for unmatched integration into any built-in setting
- 4 Independent adaptable leveling legs
- Black steel grille accepts an integrated toe kick
- Adaptable grille design allows alignment with adjacent cabinetry and toe kick/plinth
- Installation requires a customer-supplied water line and includes a 10 ft factory-installed drain line
- Gravity drain and factory-installed pump models available
- Replacement water filter part no. 601503



Stainless



Panel Ready

Model Details

Model	Pump	Finish	Description	Shipping Weight
SIIM15GDSS	No	Stainless Steel	15" Indoor Clear Ice Machine Gourmet Cube, Gravity Drain	118 lbs
SIIM15GDPR	No	Panel Ready	15" Indoor Clear Ice Machine Gourmet Cube, Gravity Drain	113 lbs
SIIM15PSS	Yes	Stainless Steel	15" Indoor Clear Ice Machine Gourmet Cube, Factory Installed Drain Pump	120 lbs
SIIM15PPR	Yes	Panel Ready	15" Indoor Clear Ice Machine Gourmet Cube, Factory Installed Drain Pump	114 lbs

Dimensions/Weight	Detail
Product Depth	23 ¼"
Product Height	34" - 35"
Product Width	14 ¾"
Product Weight	100 lbs
Shipping Dimensions	17 ¾" x 27 ½" x 36 ¾"
Shipping Weight	120 lbs

Integration/Panel Information*	Detail
Panel Height	30" - 31"
Panel Thickness	¾"
Panel Width	14 ¾"
Maximum Panel Weight	25 lbs

*Refer to manual for all panel and installation instructions



Indoor | 15" Clear Ice Machine Square Cube: Gravity Drain and Pump Models



- Produces up to 75 lbs of ¾" x ¾" x ¾" clear ice cubes per day
- Bin stores up to 25 lbs of clear ice
- Energy Star rated
- Integrated water filter system removes any impurities producing the clearest ice, filter included
- Clear ice scoop and storage hook included
- Signature SAPPHIRE blue interior
- Fully wrapped stainless-steel exterior
- Articulating, concealed self-closing hinges with built-in door stop
- Multifunction capacitive touch electronic control
- Auto shut-off when ice bin is full
- Alert notifies when time to initiate easy cleaning process
- Quiet mode feature can be set to suspend ice-making production during specific times of the day
- Full LED theater lighting
- Unit ships right hinged with field-reversible doors
- Stainless model includes a 1" diameter stainless steel handle with faceted standoffs (26" length)
- Panel ready model requires ¾" custom door panel and handle
- Precise zero clearance design allows for unmatched integration into any built-in setting
- 4 Independent adaptable leveling legs
- Black steel grille accepts an integrated toe kick
- Adaptable grille design allows alignment with adjacent cabinetry and toe kick/plinth
- Installation requires a customer-supplied water line and includes a 10 ft factory-installed drain line
- Gravity drain and factory-installed pump models available
- Replacement water filter part no. 601503



Stainless



Panel Ready

Model Details

Model	Pump	Finish	Description	Shipping Weight
SSIM15GDSS	No	Stainless Steel	15" Indoor Clear Ice Machine Square Cube, Gravity Drain	115 lbs
SSIM15GDPR	No	Panel Ready	15" Indoor Clear Ice Machine Square Cube, Gravity Drain	108 lbs
SSIM15PSS	Yes	Stainless Steel	15" Indoor Clear Ice Machine Square Cube, Factory Installed Drain Pump	115 lbs
SSIM15PPR	Yes	Panel Ready	15" Indoor Clear Ice Machine Square Cube, Factory Installed Drain Pump	111 lbs

Dimensions/Weight	Detail
Product Depth	23 ¼"
Product Height	34" - 35"
Product Width	14 ¾"
Product Weight	96 lbs
Shipping Dimensions	17 ¾" x 27 ½" x 36 ¾"
Shipping Weight	115 lbs

Integration/Panel Information*	Detail
Panel Height	30" - 31"
Panel Thickness	¾"
Panel Width	14 ¾"
Maximum Panel Weight	25 lbs

*Refer to manual for all panel and installation instructions



Model	Details
Control Type	Electronic Capacitive Touch with OLED Screen
Indoor or Outdoor	Indoor
Built-in Installation	Inset, Frameless / Overlay and Framed Cabinet Styles
Ice Size	7/8" x 7/8" x 7/8"
Ice Weight (g) per unit	11 g / 0.024 lbs
Ice Quantity per cycle	40 cubes (approx. 1 lb)
Ice Production Capacity	75 lbs
Ice Storage Capacity	25 lbs
Refrigerant Type	R290

Plumbing Water	Details
Water Inlet Adapter	3/4" OD Compression Fitting*
Water Pressure Operating Range (psi)	20 psi – 80 psi
Integrated Water Filter System	Yes
Water Usage	12 1/2 gallons per 100 lbs of ice
Factory Installed Drain Line	10 feet
Drain Required	Yes (See manual for details)
Replacement Water Filter	Part No. 601503

*Water line not included

Electrical	Details
Electrical Requirements	115 V / 60 Hz
Volt Range	104 V ~ 127 V
Electrical Service	15 amp
Running Amps	1.9 amps

Approvals – Certifications	Details
Energy Star	Yes
ETL Sanitation	Yes
UL Commercial	Yes

[Click Link to go to product page website](#)

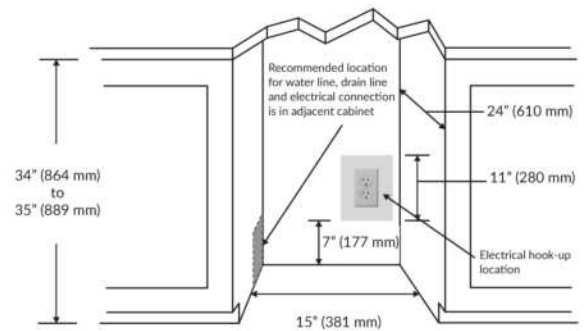

NOTE: For Gravity drain models, the drain hole cannot exceed 7 inches above the floor. For Pump models, the drain hole should be no lower than 7 inches and no higher than 4 feet above the floor.

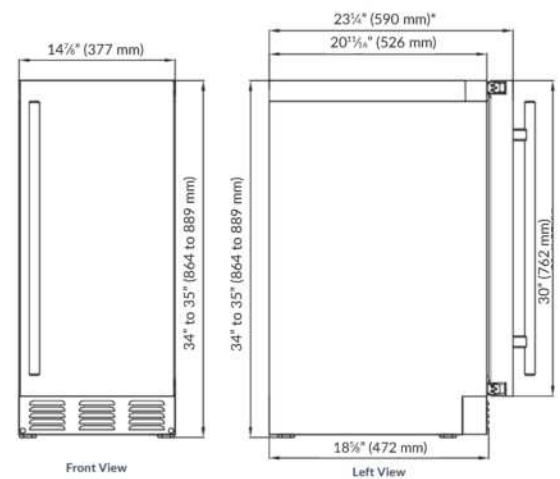

*Dimensions are the same for Panel Ready unit when 1/2" panel applied

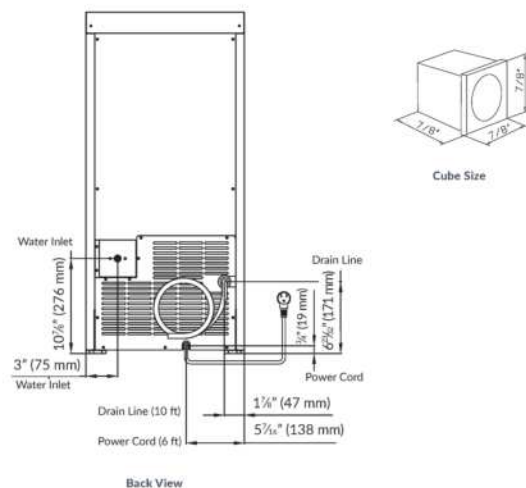

ADA Height | 15" Clear Ice Machine Square Cube: Gravity Drain and Pump Models



- ADA height compliant, installs under 34" countertop
- Produces up to 75 lbs of ¾" x ¾" x ¾" clear ice cubes per day
- Bin stores up to 25 lbs of clear ice
- Energy Star rated
- Clear ice scoop and storage hook included
- Signature SAPPHIRE blue interior
- Fully wrapped stainless-steel exterior
- Articulating, concealed self-closing hinges with built-in door stop
- Multifunction capacitive touch electronic control
- Auto shut-off when ice bin is full
- Alert notifies when time to initiate easy cleaning process
- Quiet mode feature can be set to suspend ice-making production during specific times of the day
- Full LED theater lighting
- Unit ships right hinged with field-reversible doors
- Stainless model includes a 1" diameter stainless steel handle with faceted standoffs (24" length)
- Panel ready model requires ¾" custom door panel and handle
- Precise zero clearance design allows for unmatched integration into any built-in setting
- 4 Independent adaptable leveling legs
- Black steel grille accepts an integrated toe kick
- Adaptable grille design allows alignment with adjacent cabinetry and toe kick/plinth
- Installation requires a customer-supplied water line and includes a 10 ft factory-installed drain line
- Gravity drain and factory-installed pump models available



Stainless



Panel Ready

Model Details

Model	Pump	Finish	Description	Shipping Weight
SSIM15GDSSADA	No	Stainless Steel	15" Indoor Clear Ice Square Cube, Gravity Drain	108 lbs
SSIM15GDPRADA	No	Panel Ready	15" Indoor Clear Ice Square Cube, Gravity Drain	103 lbs
SSIM15PSSADA	Yes	Stainless Steel	15" Indoor Clear Ice Square Cube, Factory Installed Drain Pump	110 lbs
SSIM15PPRADA	Yes	Panel Ready	15" Indoor Clear Ice Square Cube, Factory Installed Drain Pump	105 lbs

Dimensions/Weight	Detail
Product Depth	23 ¼"
Product Height	32" - 33"
Product Width	14 ¾"
Product Weight	91 lbs
Shipping Dimensions	17 ¾" x 27 ½" x 36 ¾"
Shipping Weight	110 lbs

Integration/Panel Information*	Detail
Panel Height	28" - 29"
Panel Thickness	¾"
Panel Width	14 ¾"
Maximum Panel Weight	25 lbs

*Refer to manual for all panel and installation instructions



Model	Details
Control Type	Electronic Capacitive Touch with OLED Screen
Indoor or Outdoor	Indoor
Built-in Installation	Inset, Frameless / Overlay and Framed Cabinet Styles
Ice Size	$\frac{7}{8}$ " x $\frac{7}{8}$ " x $\frac{7}{8}$ "
Ice Weight (g) per unit	11 g / 0.024 lbs
Ice Quantity per cycle	40 cubes (approx. 1 lb)
Ice Production Capacity	75 lbs
Ice Storage Capacity	25 lbs
Refrigerant Type	R290

Plumbing Water	Details
Water Inlet Adapter	$\frac{3}{4}$ " OD Compression Fitting*
Water Pressure Operating Range (psi)	20 psi – 80 psi
Water Usage	12 $\frac{1}{2}$ gallons per 100 lbs of ice
Factory Installed Drain Line	10 feet
Drain Required	Yes (See manual for details)

*Water line not included

Electrical	Details
Electrical Requirements	115 V / 60 Hz
Volt Range	104 V ~ 127 V
Electrical Service	15 amp
Running Amps	1.9 amps

Approvals – Certifications	Details
ADA Height Compliant	Yes
Energy Star	Yes
ETL Sanitation	Yes
UL Commercial	Yes

[Click Link to go to product page website](#)

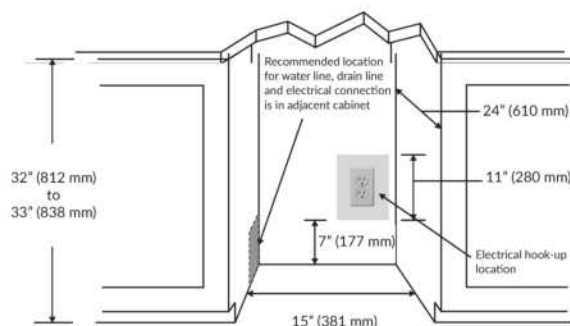

NOTE: For Gravity drain models, the drain hole cannot exceed 7 inches above the floor. For Pump models, the drain hole should be no lower than 7 inches and no higher than 4 feet above the floor.

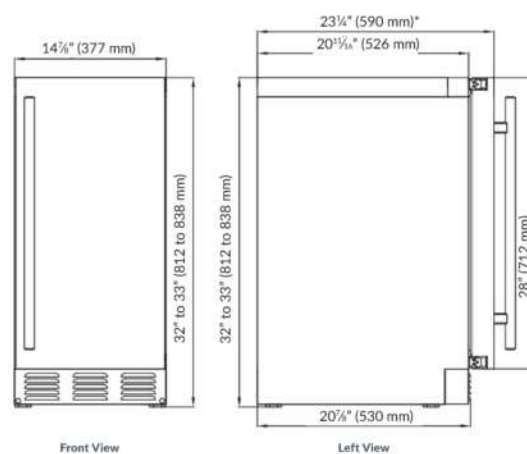

Front View

Left View

*Dimensions are the same for Panel Ready unit when $\frac{3}{4}$ " panel applied

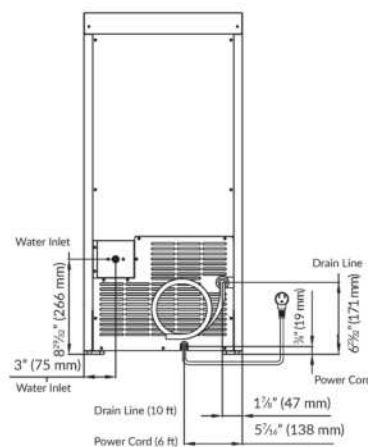

Back View

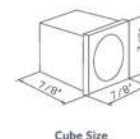

Cube Size

Outdoor | 15" Clear Ice Machine Gourmet Cube: Gravity Drain and Pump Models



- Produces up to 63 lbs of 1½" x 1½" x 1¼" clear gourmet cubes per day
- Bin stores up to 25 lbs of clear ice
- Clear ice scoop and storage hook included
- Signature SAPPHIRE blue interior
- Fully wrapped stainless-steel exterior
- Articulating, concealed self-closing hinges with built-in door stop
- Multifunction capacitive touch electronic control
- Auto shut-off when ice bin is full
- Alert notifies when time to initiate easy cleaning process
- Quiet mode feature can be set to suspend ice-making production during specific times of the day
- Full LED theater lighting
- Unit ships right hinged with field-reversible doors
- 1" Diameter stainless steel handle with faceted standoffs (26" length)
- Precise zero clearance design allows for unmatched integration into any built-in setting
- 4 Independent adaptable leveling legs
- Fixed louvered stainless steel grille
- Installation requires a customer-supplied water line and includes a 10 ft factory-installed drain line
- Gravity drain and factory-installed pump models available



Stainless

Model Details

Model	Pump	Finish	Description	Shipping Weight
SIIM15GDOD	No	Stainless Steel	15" Outdoor Clear Ice Machine Gourmet Cube, Gravity Drain	115 lbs
SIIM15POD	Yes	Stainless Steel	15" Outdoor Clear Ice Machine Gourmet Cube, Factory Installed Drain Pump	117 lbs

Dimensions/Weight	Detail
Product Depth	23 ¼"
Product Height	34" – 35"
Product Width	14 ⅞"
Product Weight	98 lbs
Shipping Dimensions	17 ¾" x 27 ½" x 36 ¾"
Shipping Weight	117 lbs



Model	Details
Control Type	Electronic Capacitive Touch with OLED Screen
Indoor or Outdoor	Outdoor
Built-in Installation	Inset, Frameless / Overlay and Framed Cabinet Styles
Ice Size	1½" x 1½" x 1¼"
Ice Weight (g) per unit	22 g / 0.0485 lbs
Ice Quantity per cycle	24 Individual Cubes (1¼ lbs)
Ice Production Capacity	63 lbs
Ice Storage Capacity	25 lbs
Refrigerant Type	R290

Plumbing Water	Details
Water Inlet Adapter	¾" OD Compression Fitting*
Water Pressure Operating Range (psi)	20 psi – 80 psi
Water Usage	16 ½ gallons per 100 lbs of ice
Factory Installed Drain Line	10 feet
Drain Required	Yes (See manual for details)

*Water line not included

Electrical	Details
Electrical Requirements	115 V / 60 Hz
Volt Range	104 V ~ 127 V
Electrical Service	15 amp
Running Amps	2.4 amps

Approvals – Certifications	Details
ETL Sanitation	Yes
UL Residential / Commercial	Yes

[Click Link to go to product page website](#)

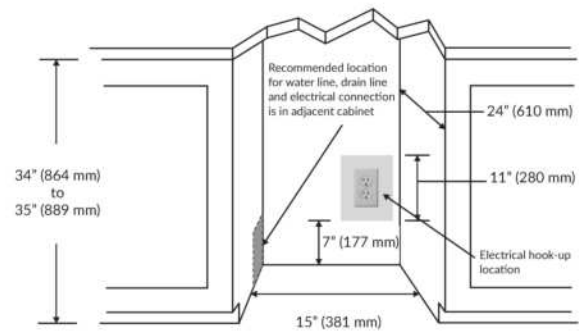

NOTE: For Gravity drain models, the drain hole cannot exceed 7 inches above the floor. For Pump models, the drain hole should be no lower than 7 inches and no higher than 4 feet above the floor.

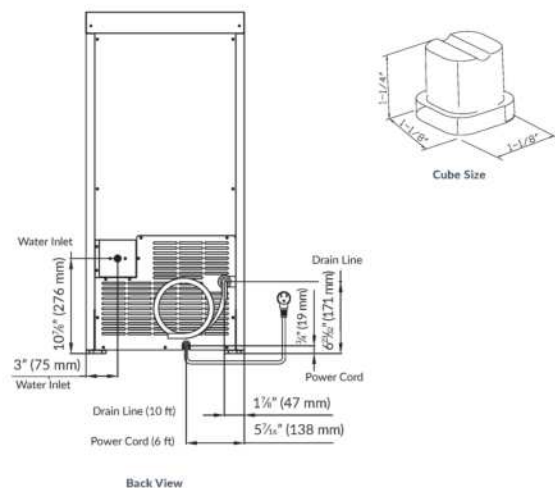
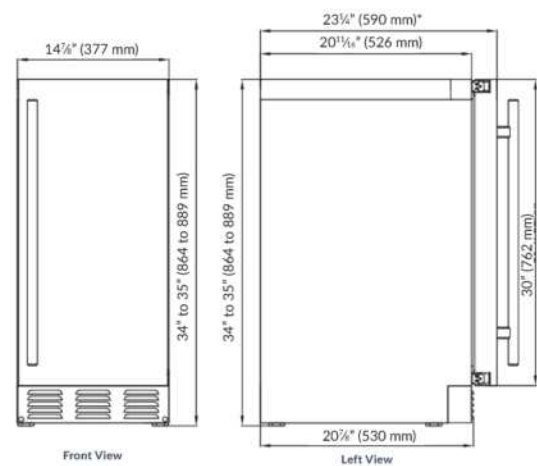

All specifications are subject to change without notice.

WINE REFRIGERATORS

Help safeguard your wine and store up to 51 standard 750 ml bottles in a Sapphire Wine Refrigerator.

All facets were considered while designing and engineering the Sapphire line. The adaptable cantilevered racking systems and wine rack inserts accommodate even the most unique-sized bottles in your wine collection. Virtually vibration-free operation alleviates any unwanted cavitation and Argon-filled UV-coated glass front doors protect your wine from light damage. Finally, the temperature control system maintains your wine for proper storage, maturation and integrity. Cheers!





Indoor
Single Zone



Indoor
Single Zone



Indoor
Dual Zone

Indoor | 15" Single Zone Wine Refrigerator



- Preserves up to 23 (750 ml) wine bottles
- Energy Star rated
- Low e, argon gas-filled triple-paned tempered glass door with uv coating
- Signature SAPPHIRE blue interior
- Full wrapped stainless-steel exterior
- Articulating, concealed self-closing hinges with built-in door stop
- Multifunction capacitive touch electronic control
- Temperature settings range from 34 °F to 65 °F; allows for ideal preservation of any collection
- Fan-assisted cooling system allows for even temperatures, quicker cooldown times, and added efficiency
- Full-length flush LED theater lighting can be set to display your collection for 4 or 6 hours or schedule nightlight feature
- Adaptable racking system includes 5 stainless front, full-extension racks with gray wine rack inserts and 1 fixed bottom display wine rack insert. Optional shelf inserts include tempered glass shelf inserts making it easy to adapt to food and beverage storage needs
- Unit ships right hinged with field-reversible doors
- Stainless model includes a 1" diameter stainless steel handle with faceted standoffs (26" length)
- Panel ready model requires ¾" custom door panel and handle
- Precise zero clearance design allows for unmatched integration into any built-in setting
- 4 Independent adaptable leveling legs
- Adaptable grille accepts an integrated toe kick and allows front/back and up/down alignment with adjacent cabinetry and toe kick/plinth
- Automatic defrost
- Lock standard on stainless model



Stainless with Lock



Panel Ready

Model Details

Model	Lock	Finish	Description	Shipping Weight
SW15SZSS	Yes	Stainless Steel Frame	15" Single Zone Wine Refrigerator, Factory Installed Lock	117 lbs
SW15SZPR	No	Panel Ready Frame	15" Single Zone Wine Refrigerator	115 lbs

Refer to page 52 for accessories

Dimensions/Weight	Detail
Product Depth	23 ¼"
Product Height	34" - 35"
Product Width	14 ¾"
Product Weight	120 lbs
Shipping Dimensions	17 ¾" x 27 ½" x 36 ¾"
Shipping Weight	117 lbs
Bottle Capacity	Up to 23 (750 ml) standard bottles

Integration/Panel Information*	Detail
Panel Height	30" - 31"
Panel Thickness	¾"
Panel Width	14 ¾"
Maximum Panel Weight	25 lbs

*Refer to manual for all panel and installation instructions



Model	Details
Control Type	Electronic Capacitive Touch with OLED Screen
Indoor or Outdoor	Indoor
Built-in Installation	Inset, Frameless / Overlay and Framed Cabinet Styles
Refrigerant Type	R600a

Electrical	Details
Electrical Requirements	115 V / 60 Hz
Volt Range	104 V ~ 127 V
Electrical Service	15 amp
Running Amps	0.6 amps

Approvals - Certifications	Details
Energy Star	Yes
ETL Residential / Commercial	Yes
ETL Sanitation	Yes
Star K	Yes

[Click Link to go to product page website](#)

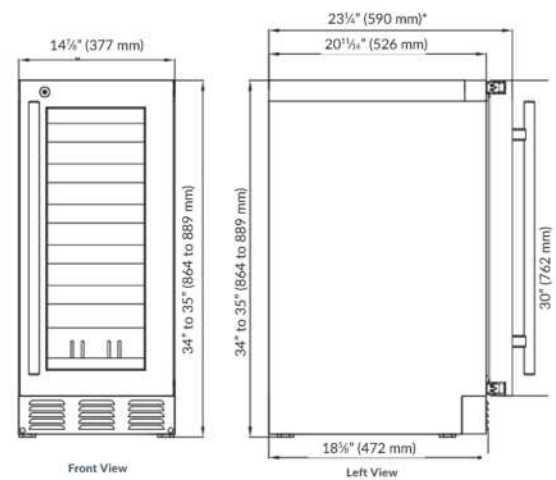
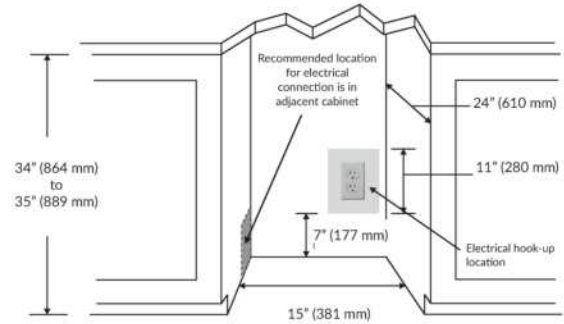

*Dimensions are the same for Panel Ready unit when 1/2" panel applied

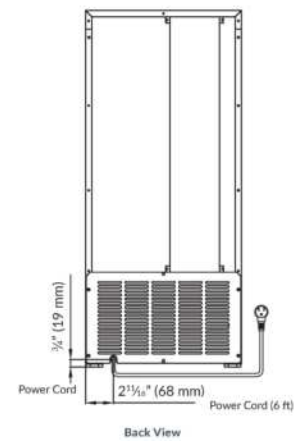

All specifications are subject to change without notice.

Indoor | 24" Single Zone Wine Refrigerator



- Preserves up to 51 (750 ml) wine bottles
- Energy Star rated
- Low e, argon gas-filled triple-paned tempered glass door with uv coating
- Signature SAPPHIRE blue interior
- Full wrapped stainless-steel exterior
- Articulating, concealed self-closing hinges with built-in door stop
- Multifunction capacitive touch electronic control
- Temperature settings range from 34 °F to 65 °F; allows for ideal preservation of any collection
- Fan-assisted cooling system allows for even temperatures, quicker cooldown times, and added efficiency
- Full-length flush LED theater lighting can be set to display your collection for 4 or 6 hours or schedule nightlight feature
- Adaptable racking system includes 7 stainless front, full-extension racks with 6 gray wine rack inserts and 1 bottom half wine rack insert. Optional shelf inserts include tempered glass shelf inserts and/or chrome-plated wire shelf inserts making it easy to adapt to food and beverage storage needs
- Unit ships right hinged with field-reversible doors
- Stainless model includes a 1" diameter stainless steel handle with faceted standoffs (26" length)
- Panel ready model requires ¾" custom door panel and handle
- Precise zero clearance design allows for unmatched integration into any built-in setting
- 4 Independent adaptable leveling legs
- Adaptable grille accepts an integrated toe kick and allows front/back and up/down alignment with adjacent cabinetry and toe kick/plinth
- Automatic defrost
- Lock standard on stainless model



Stainless with Lock



Panel Ready

Model Details

Model	Lock	Finish	Description	Shipping Weight
SW24SZSS	Yes	Stainless Steel Frame	24" Single Zone Wine Refrigerator, Factory Installed Lock	195 lbs
SW24SZPR	No	Panel Ready Frame	24" Single Zone Wine Refrigerator	188 lbs

Refer to page 53 for accessories

Dimensions/Weight	Detail
Product Depth	23 ¼"
Product Height	34" – 35"
Product Width	23 ¾"
Product Weight	165 lbs
Shipping Dimensions	26 ¾" x 27 ½" x 36 ¾"
Shipping Weight	195 lbs
Bottle Capacity	Up to 51 (750 ml) standard bottles

Integration/Panel Information*	Detail
Panel Height	30" – 31"
Panel Thickness	¾"
Panel Width	23 ¾"
Maximum Panel Weight	25 lbs

*Refer to manual for all panel and installation instructions



Model	Details
Control Type	Electronic Capacitive Touch with OLED Screen
Indoor or Outdoor	Indoor
Built-in Installation	Inset, Frameless / Overlay and Framed Cabinet Styles
Refrigerant Type	R600a

Electrical	Details
Electrical Requirements	115 V / 60 Hz
Volt Range	104 V ~ 127 V
Electrical Service	15 amp
Running Amps	0.7 amps

Approvals - Certifications	Details
Energy Star	Yes
ETL Residential / Commercial	Yes
ETL Sanitation	Yes
Star K	Yes

[Click Link to go to product page website](#)

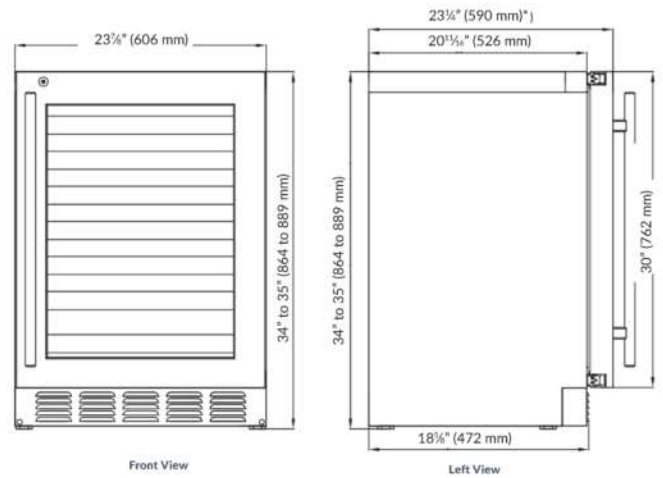
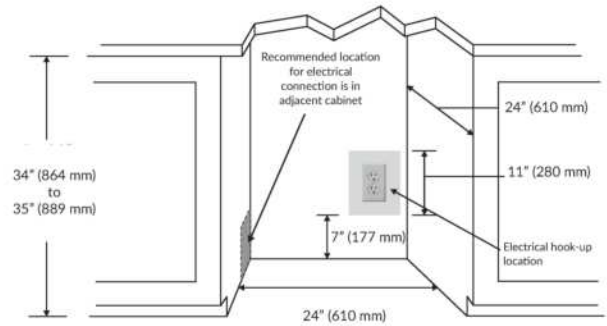

*Dimensions are the same for Panel Ready unit with 3/4" panel applied

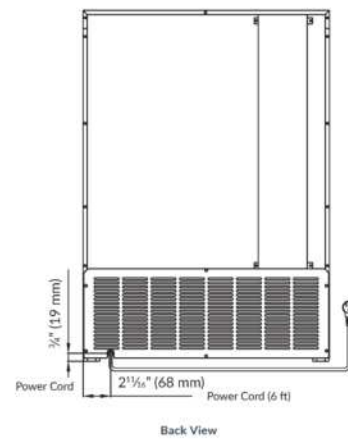

All specifications are subject to change without notice.

Indoor | 24" Dual Zone Wine Refrigerator



- Preserves up to 43 (750 ml) wine bottles
- Energy Star rated
- 2 Independently controlled dual zones
- Low e, argon gas-filled triple-paned tempered glass door with uv coating
- Signature SAPPHIRE blue interior
- Full wrapped stainless-steel exterior
- Articulating, concealed self-closing hinges with built-in door stop
- Multifunction capacitive touch electronic control
- Each zone's temperature settings range from 34 °F to 65 °F; allows for ideal preservation of any collection
- Fan-assisted cooling system allows for even temperatures, quicker cooldown times, and added efficiency
- Flush LED theater lighting can be set to display your collection for 4 or 6 hours or schedule nightlight feature
- Adaptable racking system includes 6 stainless front, full-extension racks with 5 gray wine rack inserts and 1 bottom half wine rack insert. Optional shelf inserts include tempered glass shelf inserts and/or chrome-plated wire shelf inserts making it easy to adapt to food and beverage storage needs
- Unit ships right hinged with field-reversible doors
- Stainless model includes a 1" diameter stainless steel handle with faceted standoffs (26" length)
- Panel ready model requires ¾" custom door panel and handle
- Precise zero clearance design allows for unmatched integration into any built-in setting
- 4 Independent adaptable leveling legs
- Adaptable grille accepts an integrated toe kick and allows front/back and up/down alignment with adjacent cabinetry and toe kick/plinth
- Automatic defrost
- Lock standard on stainless model

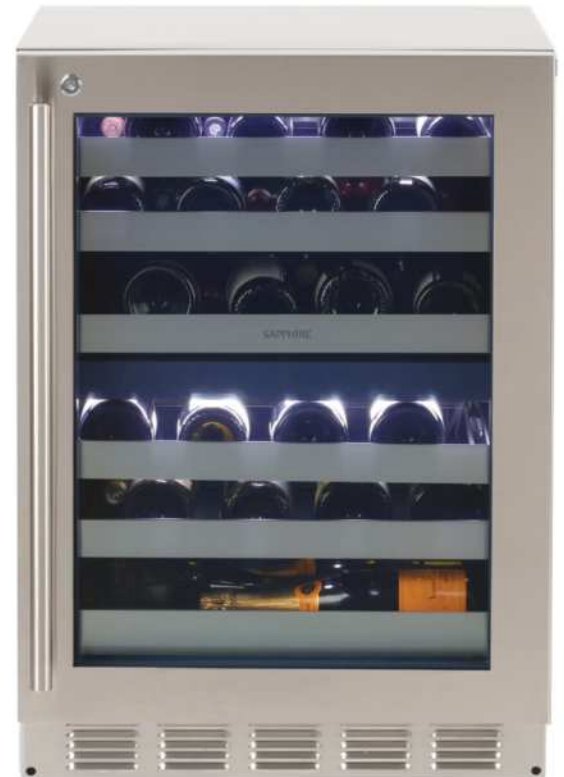

Stainless with Lock



Panel Ready

Model Details

Model	Lock	Finish	Description	Shipping Weight
SW24DZSS	Yes	Stainless Steel Frame	24" Dual Zone Wine Refrigerator, Factory Installed Lock	194 lbs
SW24DZPR	No	Panel Ready Frame	24" Dual Zone Wine Refrigerator	187 lbs

Refer to page 53 for accessories

Dimensions/Weight	Detail
Product Depth	23 ¼"
Product Height	34" - 35"
Product Width	23 ¾"
Product Weight	164 lbs
Shipping Dimensions	26 ¾" x 27 ½" x 36 ¾"
Shipping Weight	194 lbs
Bottle Capacity	Up to 43 (750 ml) standard bottles

Integration/Panel Information*	Detail
Panel Height	30" - 31"
Panel Thickness	¾"
Panel Width	23 ¾"
Maximum Panel Weight	25 lbs

*Refer to manual for all panel and installation instructions



Model	Details
Control Type	Electronic Capacitive Touch with OLED Screen
Indoor or Outdoor	Indoor
Built-in Installation	Inset, Frameless / Overlay and Framed Cabinet Styles
Refrigerant Type	R600a

Electrical	Details
Electrical Requirements	115 V / 60 Hz
Volt Range	104 V ~ 127 V
Electrical Service	15 amp
Running Amps	0.7 amps

Approvals - Certifications	Details
Energy Star	Yes
ETL Residential / Commercial	Yes
ETL Sanitation	Yes
Star K	Yes

[Click Link to go to product page website](#)

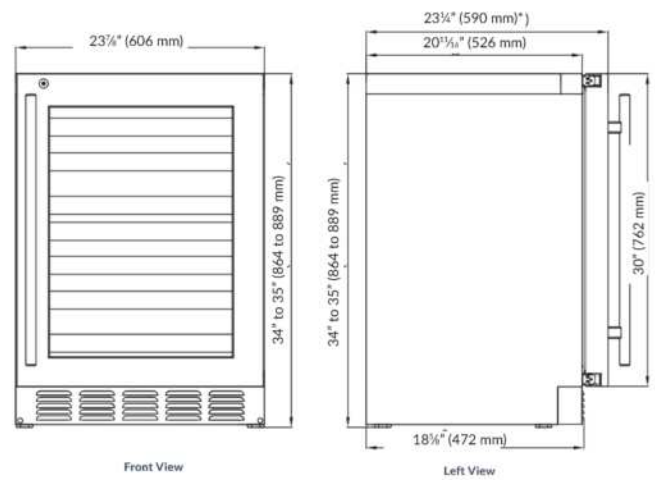
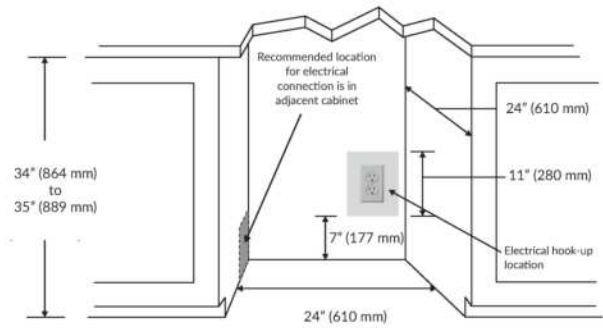

*Dimensions are the same for Panel Ready unit when 3/8" panel applied

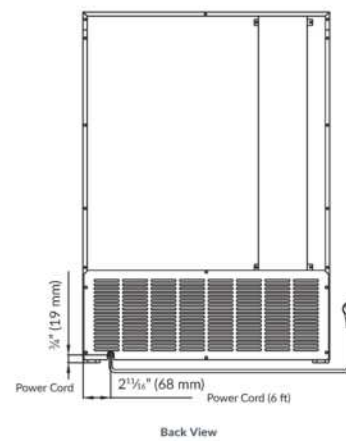

All specifications are subject to change without notice.

BEVERAGE CENTERS

The Sapphire Beverage Center products provide convenience, flexibility and value anywhere in your home.

These units are beautifully designed with the signature Sapphire Blue interior and illuminate with full LED theater lighting. Sapphire models have been engineered with a cantilevered racking system and interchangeable shelf and rack inserts, making it easy to accommodate your current food and beverage storage needs and adapt as your preferences evolve over time – all in the same unit.





**Indoor
Beverage Center**



**ADA Height
Beverage Center**



- Volume of 5.1 cubic feet, holds 8 standard wine bottles and (147) 12 oz cans or (79) 12 oz bottles
- Signature SAPPHIRE blue interior
- Full wrapped stainless-steel exterior
- Articulating, concealed self-closing hinges with built-in door stop
- Low e, argon gas-filled triple-paned tempered glass door with uv coating
- Multifunction capacitive touch electronic control
- Temperature range: 34 °F to 65 °F
- Fan-assisted cooling system allows for even temperatures, quicker cooldown times, and added efficiency
- Full-length flush LED theater lighting can be set to display your collection for 4 or 6 hours or schedule nightlight feature
- Adaptable racking system includes 3 stainless front, full-extension racks with 2 tempered glass shelf inserts and 1 gray wine rack insert. Optional shelf inserts include gray wine rack inserts and/or chrome-plated wire shelf inserts making it easy to adapt to food and beverage storage needs
- Clear bottom crisper drawer
- Unit ships right hinged with field-reversible doors
- Stainless model includes 1" diameter stainless steel handle with faceted standoffs (26" length)
- Panel ready model requires 3/4" custom door panel and handle
- Precise zero clearance design allows for unmatched integration into any built-in setting
- 4 Independent adaptable leveling legs
- Adaptable grille accepts an integrated toe kick and allows front/back and up/down alignment with adjacent cabinetry and toe kick/plinth
- Automatic defrost
- Lock standard on stainless model



Stainless with Lock



Panel Ready

Model Details

Model	Lock	Finish	Description	Shipping Weight
SBCR24SS	Yes	Stainless Steel	24" Beverage Center, Factory Installed Lock	180 lbs
SBCR24PR	No	Panel Ready	24" Beverage Center	172 lbs

Refer to page 53 for accessories

Dimensions/Weight	Detail
Product Depth	23 3/4"
Product Height	34" - 35"
Product Width	23 3/8"
Product Weight	149 lbs
Product Volume	5.1 cu ft
Shipping Dimensions	26 3/4" x 27 1/2" x 36 3/4"
Shipping Weight	180 lbs

Integration/Panel Information*	Detail
Panel Height	30" - 31"
Panel Thickness	3/4"
Panel Width	23 3/8"
Maximum Panel Weight	25 lbs

*Refer to manual for all panel and installation instructions



Model	Details
Control Type	Electronic Capacitive Touch with OLED Screen
Indoor or Outdoor	Indoor
Built-in Installation	Inset, Frameless / Overlay and Framed Cabinet Styles
Refrigerant Type	R600a

Electrical	Details
Electrical Requirements	115 V / 60 Hz
Volt Range	104 V ~ 127 V
Electrical Service	15 amp
Running Amps	0.7 amps

Approvals - Certifications	Details
ETL Residential / Commercial	Yes
ETL Sanitation	Yes
Star K	Yes

Capacities	Details
Maximum Shelf Weight	75 lbs
12 oz Can Capacity	147 Cans (Max)
12 oz Bottle Capacity	79 Bottles (Max)

[Click Link to go to product page website](#)

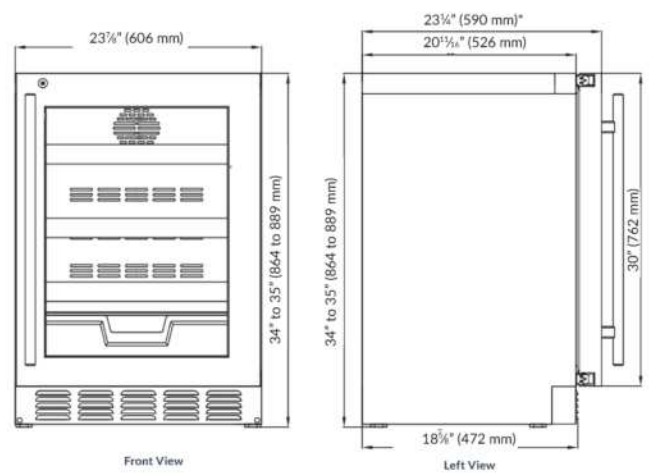
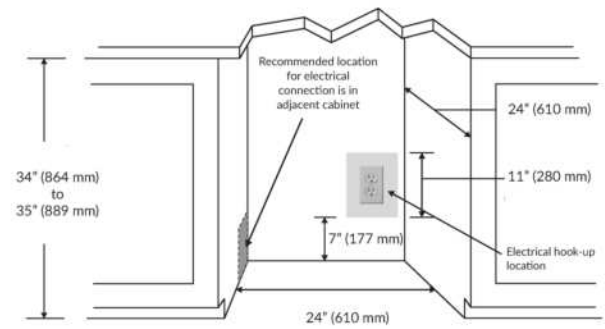

*Dimensions are the same for Panel Ready unit when 1/2" panel applied

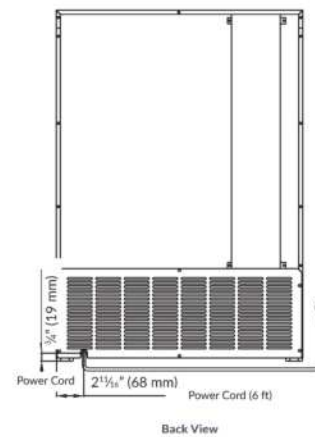

All specifications are subject to change without notice.

ADA Height | 24" Beverage Center



- Volume of 4.7 cubic feet, holds (105) 12 oz cans or (70) 12 oz bottles
- ADA height compliant, installs under 34" countertop
- Signature SAPPHIRE blue interior
- Full wrapped stainless-steel exterior
- Articulating, concealed self-closing hinges with built-in door stop
- Low e, argon gas-filled triple-paned tempered glass door with uv coating
- Multifunction capacitive touch electronic control
- Temperature range: 34 °F to 65 °F
- Fan-assisted cooling system allows for even temperatures, quicker cooldown times, and added efficiency
- Full-length flush LED theater lighting can be set to display your collection for 4 or 6 hours or schedule nightlight feature
- Adaptable racking system includes 3 stainless front, full-extension racks with 3 chrome-plated wire shelves and 1 gray wine rack insert. Optional shelf inserts include gray wine rack inserts and/or tempered glass shelf inserts making it easy to adapt to food and beverage storage needs
- Clear bottom crisper drawer
- Volume of 4.7 cubic feet
- Unit ships right hinged with field-reversible doors
- Stainless model includes 1" diameter stainless steel handle with faceted standoffs (24" length)
- Panel ready model requires 3/4" custom door panel and handle
- Precise zero clearance design allows for unmatched integration into any built-in setting
- 4 Independent adaptable leveling legs
- Adaptable grille accepts an integrated toe kick and allows front/back and up/down alignment with adjacent cabinetry and toe kick/plinth
- Automatic defrost
- Lock standard on stainless model



Stainless with Lock



Panel Ready

Model Details

Model	Lock	Finish	Description	Shipping Weight
SBCR24SSADA	Yes	Stainless Steel	24" Beverage Center, Factory Installed Lock	169 lbs
SBCR24PRADA	No	Panel Ready	24" Beverage Center	162 lbs

Refer to page 53 for accessories

Dimensions/Weight	Detail
Product Depth	23 1/4"
Product Height	32" - 33"
Product Width	23 7/8"
Product Weight	140 lbs
Product Volume	4.7 cu ft
Shipping Dimensions	26 3/4" x 27 1/2" x 36 3/4"
Shipping Weight	169 lbs

Integration/Panel Information*	Detail
Panel Height	28" - 29"
Panel Thickness	3/4"
Panel Width	23 3/8"
Maximum Panel Weight	25 lbs

*Refer to manual for all panel dimensions and installation instructions



Model	Details
Control Type	Electronic Capacitive Touch with OLED Screen
Indoor or Outdoor	Indoor
Built-in Installation	Inset, Frameless / Overlay and Framed Cabinet Styles
Refrigerant Type	R600a

Electrical	Details
Electrical Requirements	115 V / 60 Hz
Volt Range	104 V ~ 127 V
Electrical Service	15 amp
Running Amps	0.7 amps

Approvals - Certifications	Details
ETL Residential / Commercial	Yes
ETL Sanitation	Yes
Star K	Yes

Capacities	Details
Maximum Shelf Weight	75 lbs
12 oz Can Capacity	105 Cans (Max)
12 oz Bottle Capacity	70 Bottles (Max)

[Click Link to go to product page website](#)

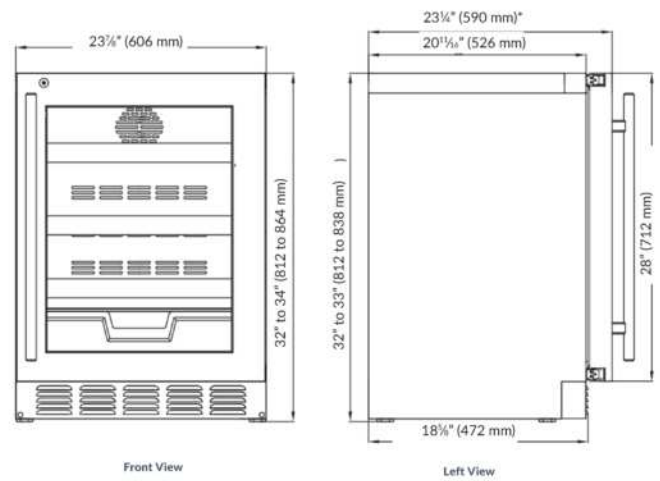
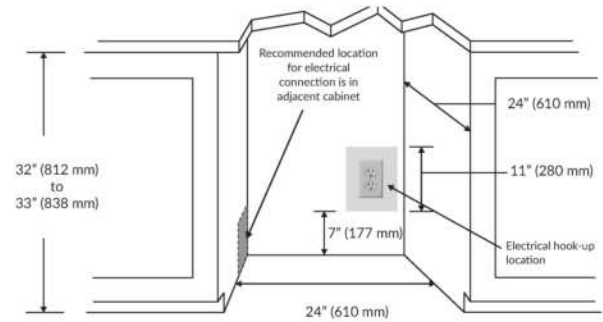

*Dimensions are the same for Panel Ready unit when 3/4" panel applied

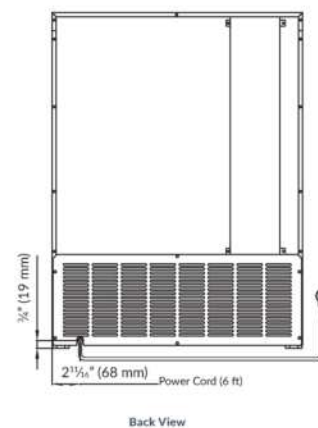

All specifications are subject to change without notice.

REFRIGERATORS

Perfect for your kitchen, bar, gym, home theater or outdoor entertainment area, Sapphire offers both 15" and 24" width solid door refrigerator models for inside or outside the home.

With slide-out, full extension, easily adjustable glass or chrome wire shelf inserts and clear storage bins, Sapphire units offer maximum storage optimization.





Indoor
Refrigerator



Indoor
Refrigerator



ADA Height
Refrigerator



Outdoor
Refrigerator



- Volume of 2.8 cubic feet, holds (78) 12 oz cans or (48) 12 oz bottles
- Energy Star rated
- Signature SAPPHIRE blue interior
- Full wrapped stainless-steel exterior
- Articulating, concealed self-closing hinges with built-in door stop
- Multifunction capacitive touch electronic control
- Temperature range: 34 °F to 65 °F
- Fan-assisted cooling system allows for even temperatures, quicker cooldown times, and added efficiency
- Full-length flush LED theater lighting
- Adaptable racking system includes 3 stainless front, full-extension racks with tempered glass shelf inserts. Optional shelf inserts include gray wine rack inserts making it easy to adapt to food and beverage storage needs
- Unit ships right hinged with field-reversible doors
- Stainless model includes a 1" diameter stainless steel handle with faceted standoffs (26" length)
- Panel ready model requires ¾" custom door panel and handle
- Precise zero clearance design allows for unmatched integration into any built-in setting
- 4 Independent adaptable leveling legs
- Adaptable grille accepts an integrated toe kick and allows front/back and up/down alignment with adjacent cabinetry and toe kick/plinth
- Automatic defrost
- Lock standard on stainless model



Stainless with Lock



Panel Ready

Model Details

Model	Lock	Finish	Description	Shipping Weight
SR15SS	Yes	Stainless Steel	15" Indoor Refrigerator, Factory Installed Lock	122 lbs
SR15PR	No	Panel Ready	15" Indoor Refrigerator	118 lbs

Refer to page 52 for accessories

Dimensions/Weight	Detail
Product Depth	23 ¼"
Product Height	34" - 35"
Product Width	14 7/8"
Product Weight	99 lbs
Product Volume	2.8 cu ft
Shipping Dimensions	17 ¾" x 27 ½" x 36 ¾"
Shipping Weight	122 lbs

Integration/Panel Information*	Detail
Panel Height	30" - 31"
Panel Thickness	¾"
Panel Width	23 ¾"
Maximum Panel Weight	25 lbs

*Refer to manual for all panel and installation instructions



Model	Details
Control Type	Electronic Capacitive Touch with OLED Screen
Indoor or Outdoor	Indoor
Built-in Installation	Inset, Frameless / Overlay and Framed Cabinet Styles
Refrigerant Type	R600a

Electrical	Details
Electrical Requirements	115 V / 60 Hz
Volt Range	104 V ~ 127 V
Electrical Service	15 amp
Running Amps	0.6 amps

Approvals - Certifications	Details
Energy Star	Yes
ETL Residential / Commercial	Yes
ETL Sanitation	Yes
Star K	Yes

Capacities	Details
Maximum Shelf Weight	75 lbs
12 oz Can Capacity	78 Cans (Max)
12 oz Bottle Capacity	48 Bottles (Max)

[Click Link to go to product page website](#)

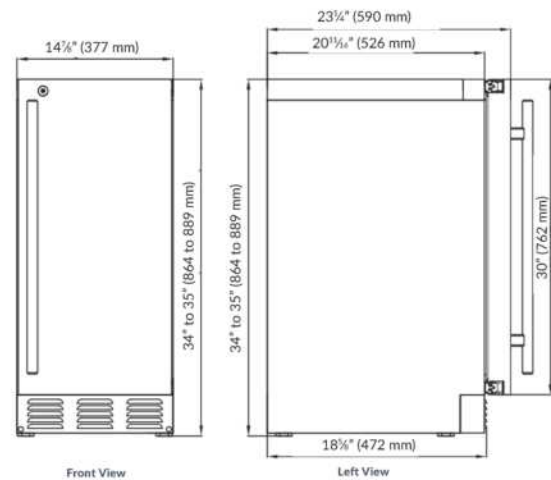
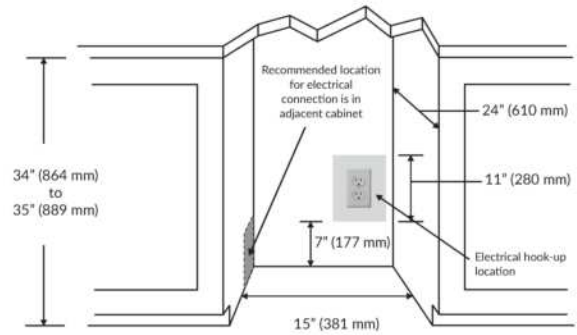

*Dimensions are the same for Panel Ready unit when 3/4" panel applied

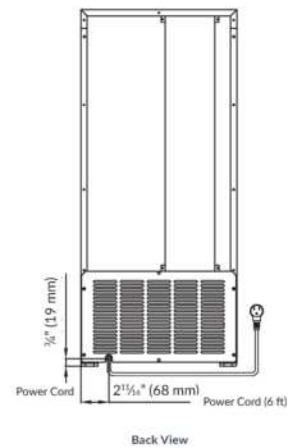

All specifications are subject to change without notice.



- Volume of 5.1 cubic feet, holds (147) 12 oz cans or (103) 12 oz bottles
- Energy Star rated
- Signature SAPPHIRE blue interior
- Full wrapped stainless-steel exterior
- Articulating, concealed self-closing hinges with built-in door stop
- Multifunction capacitive touch electronic control
- Temperature range: 34 °F to 65 °F
- Fan-assisted cooling system allows for even temperatures, quicker cooldown times, and added efficiency
- Full-length flush LED theater lighting
- Adaptable racking system includes 3 stainless front, full-extension racks with tempered glass shelf inserts. Optional shelf inserts include gray wine rack inserts and/or chrome-plated wire shelf inserts making it easy to adapt to food and beverage storage needs
- Clear bottom crisper drawer
- Unit ships right hinged with field-reversible doors
- Stainless model includes 1" diameter stainless steel handle with faceted standoffs (26" length)
- Panel ready model requires ¾" custom door panel and handle
- Precise zero clearance design allows for unmatched integration into any built-in setting
- 4 Independent adaptable leveling legs
- Adaptable grille accepts an integrated toe kick and allows front/back and up/down alignment with adjacent cabinetry and toe kick/plinth
- Automatic defrost
- Lock standard on stainless model



Stainless with Lock



Panel Ready

Model Details

Model	Lock	Finish	Description	Shipping Weight
SR24SS	Yes	Stainless Steel	24" Indoor Refrigerator, Factory Installed Lock	163 lbs
SR24PR	No	Panel Ready	24" Indoor Refrigerator	155 lbs

Refer to page 53 for accessories

Dimensions/Weight	Detail
Product Depth	23 ¼"
Product Height	34" - 35"
Product Width	23 7/8"
Product Weight	133 lbs
Product Volume	5.1 cu ft
Shipping Dimensions	26 ¾" x 27 ½" x 36 ¾"
Shipping Weight	163 lbs

Integration/Panel Information*	Detail
Panel Height	30" - 31"
Panel Thickness	¾"
Panel Width	23 ¾"
Maximum Panel Weight	25 lbs

*Refer to manual for all panel and installation instructions



Model	Details
Control Type	Electronic Capacitive Touch with OLED Screen
Indoor or Outdoor	Indoor
Built-in Installation	Inset, Frameless / Overlay and Framed Cabinet Styles
Refrigerant Type	R600a

Electrical	Details
Electrical Requirements	115 V / 60 Hz
Volt Range	104 V ~ 127 V
Electrical Service	15 amp
Running Amps	0.7 amps

Approvals - Certifications	Details
Energy Star	Yes
ETL Residential / Commercial	Yes
ETL Sanitation	Yes
Star K	Yes

Capacities	Details
Maximum Shelf Weight	75 lbs
12 oz Can Capacity	147 Cans (Max)
12 oz Bottle Capacity	63 Bottles (Max)

[Click Link to go to product page website](#)

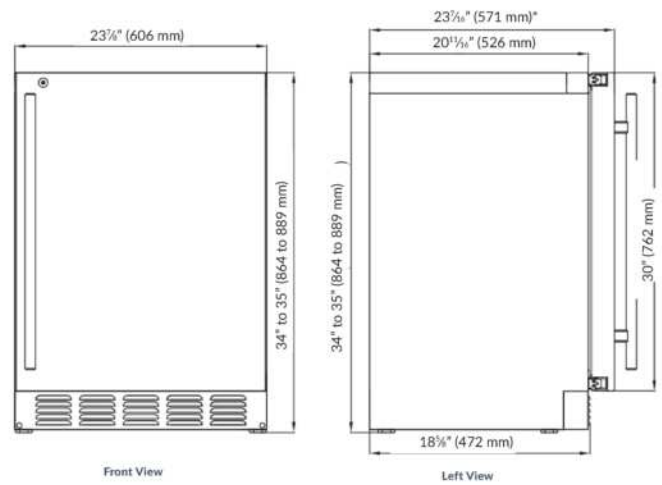
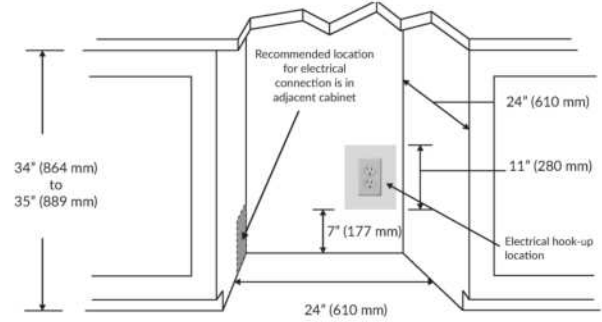

*Dimensions are the same for Panel Ready unit when 1/2" panel applied

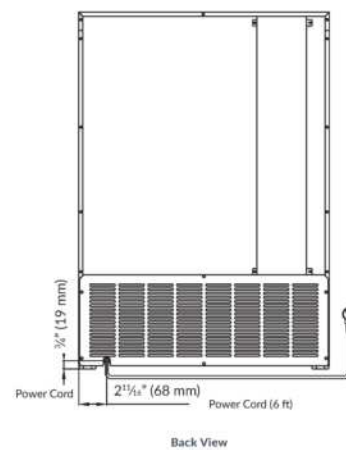

All specifications are subject to change without notice.



- Volume of 4.7 cubic feet, holds (147) 12 oz cans or (85) 12 oz bottles
- Energy Star rated
- ADA height compliant, installs under 34" countertop
- Signature SAPPHIRE blue interior
- Full wrapped stainless-steel exterior
- Articulating, concealed self-closing hinges with built-in door stop
- Multifunction capacitive touch electronic control
- Temperature range: 34 °F to 65 °F
- Fan-assisted cooling system allows for even temperatures, quicker cooldown times, and added efficiency
- Full-length flush LED theater lighting
- Adaptable racking system includes 3 stainless front, full-extension racks with chrome-plated wire inserts. Optional shelf inserts include gray wine rack inserts and/or tempered glass shelf inserts making it easy to adapt to food and beverage storage needs
- Clear bottom crisper drawer
- Unit ships right hinged with field-reversible doors
- Stainless model includes 1" diameter stainless steel handle with faceted standoffs (24" length)
- Panel ready model requires ¾" custom door panel and handle
- Precise zero clearance design allows for unmatched integration into any built-in setting
- 4 Independent adaptable leveling legs
- Adaptable grille accepts an integrated toe kick and allows front/back and up/down alignment with adjacent cabinetry and toe kick/plinth
- Automatic defrost
- Lock standard on stainless models



Stainless with Lock



Panel Ready

Model Details

Model	Lock	Finish	Description	Shipping Weight
SR24SSADA	Standard	Stainless Steel	24" ADA Refrigerator, Factory Installed Lock	154 lbs
SR24PRADA	No	Panel Ready	24" ADA Refrigerator	148 lbs

Refer to page 53 for accessories

Dimensions/Weight	Detail
Product Depth	23 ¼"
Product Height	32" - 33"
Product Width	23 ¾"
Product Weight	126 lbs
Product Volume	4.7 cu ft
Shipping Dimensions	26 ¾" x 27 ½" x 36 ¾"
Shipping Weight	154 lbs

Integration/Panel Information*	Detail
Panel Height	28" - 29"
Panel Thickness	¾"
Panel Width	23 ¾"
Maximum Panel Weight	25 lbs

*Refer to manual for all panel and installation instructions



Model	Details
Control Type	Electronic Capacitive Touch with OLED Screen
Indoor or Outdoor	Indoor
Built-in Installation	Inset, Frameless / Overlay and Framed Cabinet Styles
Refrigerant Type	R600a

Electrical	Details
Electrical Requirements	115 V / 60 Hz
Volt Range	104 V ~ 127 V
Electrical Service	15 amp
Running Amps	0.7 amps

Approvals - Certifications	Details
ADA Height Compliant	Yes
Energy Star	Yes
ETL Residential / Commercial	Yes
ETL Sanitation	Yes
Star K	Yes

Capacities	Details
Maximum Shelf Weight	75 lbs
12 oz Can Capacity	147 Cans (Max)
12 oz Bottle Capacity	85 Bottles (Max)

[Click Link to go to product page website](#)

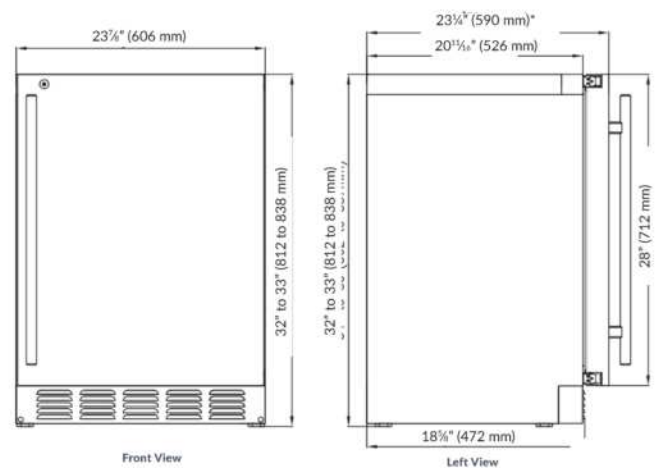
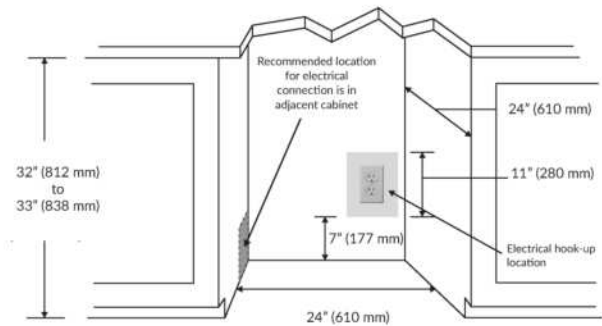

*Dimensions are the same for Panel Ready unit when 1/2\"/>

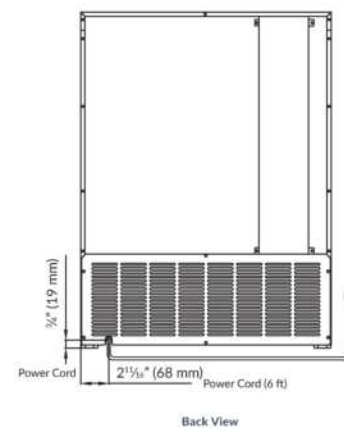

All specifications are subject to change without notice.



- Volume of 5.1 cubic feet, holds (147) 12 oz cans or (63) 12 oz bottles
- Signature SAPPHIRE blue interior
- Full wrapped stainless-steel exterior
- Articulating, concealed self-closing hinges with built-in door stop
- Multifunction capacitive touch electronic control
- Temperature range: 34 °F to 65 °F
- Fan-assisted cooling system allows for even temperatures, quicker cooldown times, and added efficiency
- Full-length flush LED theater lighting
- Adaptable racking system includes 3 stainless front, full-extension racks with chrome-plated wire inserts. Optional shelf inserts include gray wine rack inserts and/or tempered glass shelf inserts making it easy to adapt to food and beverage storage needs
- Clear bottom crisper drawer
- Unit ships right hinged with field-reversible doors
- 1" Diameter stainless steel handle with faceted standoffs (26" length)
- Precise zero clearance design allows for unmatched integration into any built-in setting
- 4 Independent adaptable leveling legs
- Fixed louvered stainless steel grille
- Automatic defrost
- Lock standard on stainless model



Stainless with Lock

Model Details

Model	Lock	Finish	Description	Shipping Weight
SR24OD	Standard	Stainless Steel	24" Outdoor Refrigerator, Factory Installed Lock	159 lbs

Refer to page 53 for accessories

Dimensions/Weight	Detail
Product Depth	23 ¼"
Product Height	34" - 35"
Product Width	23 7/8"
Product Weight	130 lbs
Product Volume	5.1 cu ft
Shipping Dimensions	26 ¾" x 27 ½" x 36 ¾"
Shipping Weight	159 lbs



Model	Details
Control Type	Electronic Capacitive Touch with OLED Screen
Indoor or Outdoor	Indoor
Built-in Installation	Inset, Frameless / Overlay and Framed Cabinet Styles
Refrigerant Type	R600a

Electrical	Details
Electrical Requirements	115 V / 60 Hz
Volt Range	104 V ~ 127 V
Electrical Service	15 amp
Running Amps	0.7 amps

Approvals - Certifications	Details
ETL Residential / Commercial	Yes
ETL Sanitation	Yes
Star K	Yes

Capacities	Details
Maximum Shelf Weight	75 lbs
12 oz Can Capacity	147 Cans (Max)
12 oz Bottle Capacity	63 Bottles (Max)

[Click Link to go to product page website](#)

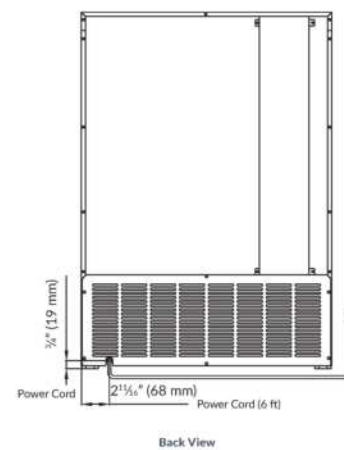
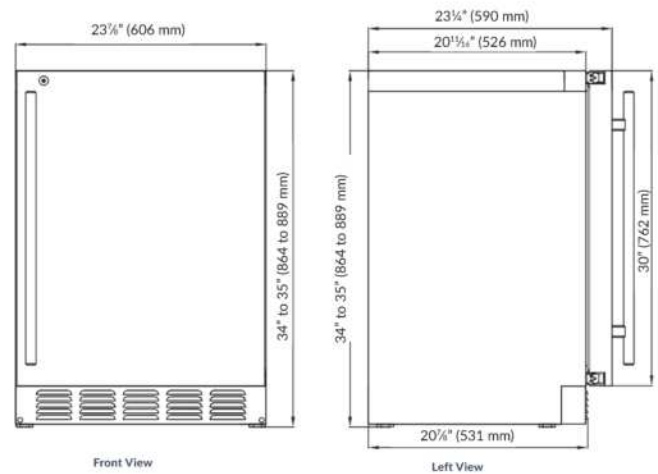
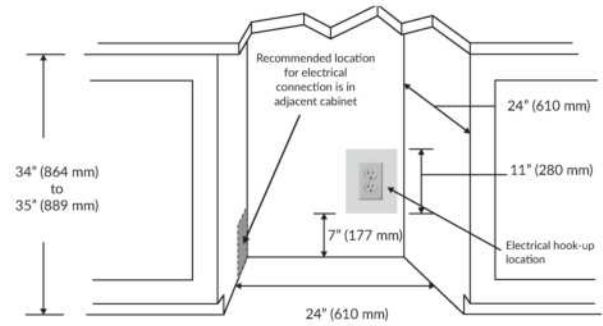

All specifications are subject to change without notice.

REFRIGERATOR DRAWERS

When drawers, not cabinet doors, are at the forefront of your design, place a Drawer model in your home or outdoor design.

Sapphire offers enhanced accessibility with full-extension stainless steel lined drawers with dividers - to allow access to your food, condiments, beverages and other refrigerated goods.





Indoor
Drawers



Outdoor
Drawers



- Volume of 4.6 cubic feet, holds (147) 12 oz cans or (93) 12 oz bottles
- Energy Star rated
- Holds milk gallons
- Signature SAPPHIRE blue interior
- Full wrapped stainless-steel exterior
- 2 Full-extension stainless steel lined drawers
- Multifunction capacitive touch electronic control
- Temperature range: 34 °F to 65 °F
- Fan-assisted cooling system allows for even temperatures, quicker cooldown times, and added efficiency
- Full LED theater lighting
- Adaptable stainless steel dividers in each drawer allows customization of drawer space
- Stainless model includes 1" diameter stainless steel handles with faceted standoffs (22" length)
- Panel ready model requires ¾" custom door panel and handle
- 4 Independent adaptable leveling legs
- Adaptable grille accepts an integrated toe kick and allows front/back and up/down alignment with adjacent cabinetry and toe kick/plinth
- Automatic defrost
- Lock standard on stainless model



Stainless with Lock



Panel Ready

Model Details

Model	Lock	Finish	Description	Shipping Weight
SRD24SS	Yes	Stainless Steel	24" Indoor Refrigerator Drawers, Factory Installed Lock	157 lbs
SRD24PR	No	Panel Ready	24" Indoor Refrigerator Drawers	154 lbs

Dimensions/Weight	Detail
Product Depth	23 ¼"
Product Height	34" - 35"
Product Width	23 ⅞"
Product Weight	127 lbs
Product Volume	4.6 cu ft
Shipping Dimensions	26 ¾" x 27 ½" x 36 ¾"
Shipping Weight	157 lbs

Integration/Panel Information*	Detail
Panel Height	2 Panels: 14 ⅞" each
Panel Thickness	¾"
Panel Width	23 ⅞"
Maximum Panel Weight	25 lbs

*Refer to manual for all panel and installation instructions



Model	Details
Control Type	Electronic Capacitive Touch with OLED Screen
Indoor or Outdoor	Indoor
Built-in Installation	Inset, Frameless / Overlay and Framed Cabinet Styles
Refrigerant Type	R600a

Electrical	Details
Electrical Requirements	115 V / 60 Hz
Volt Range	104 V ~ 127 V
Electrical Service	15 amp
Running Amps	0.7 amps

Approvals - Certifications	Details
ETL Residential / Commercial	Yes
ETL Sanitation	Yes
Star K	Yes

Capacities	Details
Maximum Shelf Weight	110 lbs
12 oz Can Capacity	147 Cans (Max)
12 oz Bottle Capacity	93 Bottles (Max)

[Click Link to go to product page website](#)

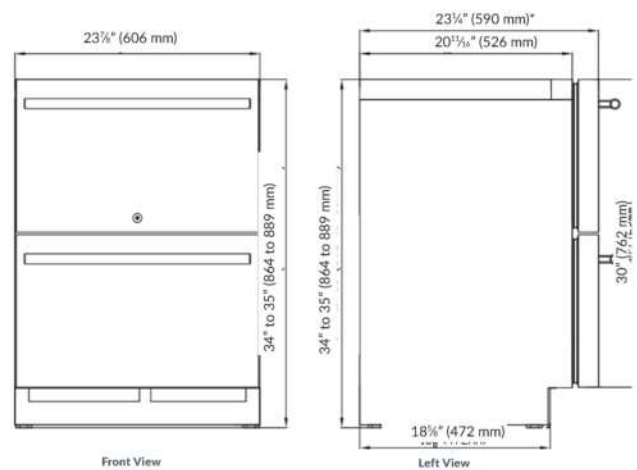
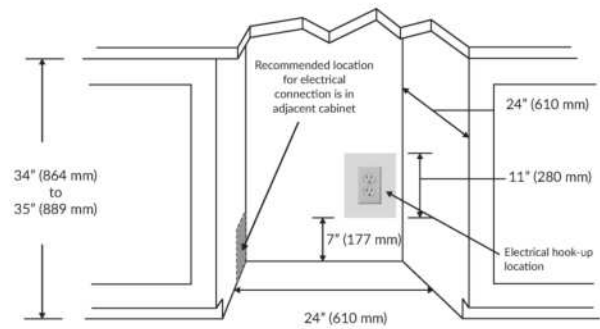

*Dimensions are the same for Panel Ready unit when 3/8" panel applied

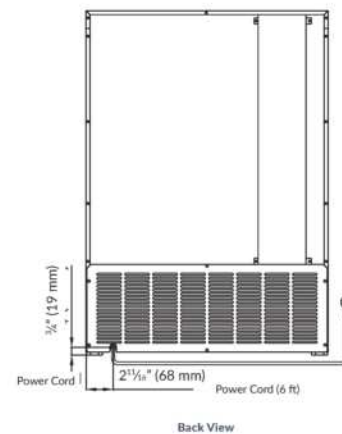

All specifications are subject to change without notice.

Outdoor | 24" Refrigerator Drawers



- Volume of 4.6 cubic feet, holds (147) 12 oz cans or (93) 12 oz bottles
- Holds milk gallons
- Signature SAPPHIRE blue interior
- Full wrapped stainless-steel exterior
- 2 Full-extension stainless steel lined drawers
- Multifunction capacitive touch electronic control
- Temperature range: 34 °F to 65 °F
- Fan-assisted cooling system allows for even temperatures, quicker cooldown times, and added efficiency
- Full LED theater lighting
- Adaptable stainless steel dividers in each drawer allows customization of drawer space
- 1" Diameter stainless steel handles with faceted standoffs (22" length)
- 4 Independent adaptable leveling legs
- Fixed louvered stainless steel grille
- Automatic defrost
- Lock standard



Stainless with Lock

Model Details

Model	Lock	Finish	Description	Shipping Weight
SRD24OD	Standard	Stainless Steel	24" Outdoor Refrigerator Drawers, Factory Installed Lock	157 lbs

Dimensions/Weight	Detail
Product Depth	23 ¼"
Product Height	34" - 35"
Product Width	23 7/8"
Product Weight	129 lbs
Product Volume	4.6 cu ft
Shipping Dimensions	26 ¾" x 27 ½" x 36 ¾"
Shipping Weight	157 lbs



Model	Details
Control Type	Electronic Capacitive Touch with OLED Screen
Indoor or Outdoor	Indoor
Built-in Installation	Inset, Frameless / Overlay and Framed Cabinet Styles
Refrigerant Type	R600a

Electrical	Details
Electrical Requirements	115 V / 60 Hz
Volt Range	104 V ~ 127 V
Electrical Service	15 amp
Running Amps	0.7 amps

Approvals - Certifications	Details
ETL Residential / Commercial	Yes
ETL Sanitation	Yes
Star K	Yes

Capacities	Details
Maximum Shelf Weight	110 lbs
12 oz Can Capacity	147 Cans (Max)
12 oz Bottle Capacity	93 Bottles (Max)

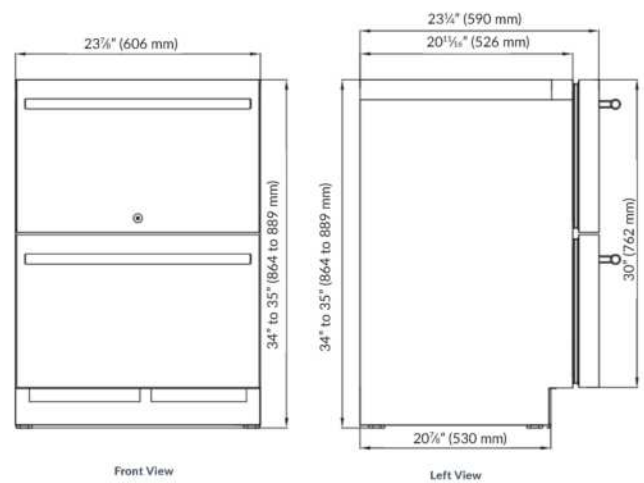
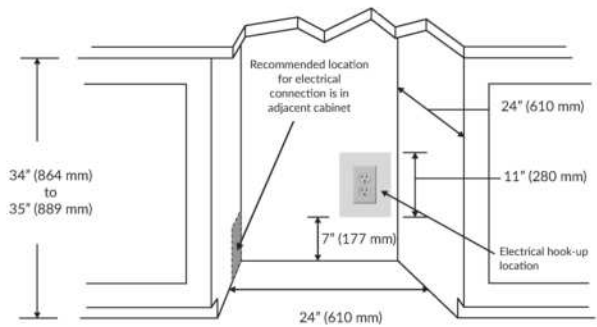

Front View

Left View

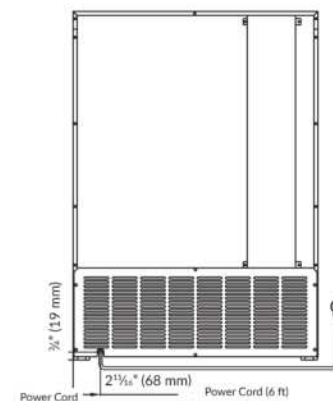

Back View

[Click Link to go to product page website](#)

All specifications are subject to change without notice.

ACCESSORIES

Sapphire is engineered to give you the ability to manage a variety of wine bottles, can sizes and other refrigerated needs.

The cantilevered racking system and interchangeable inserts make it easy to adapt to most food and beverage storage.

Inserts are available with wine racks, tempered glass shelves and chrome-plated wire shelves if out of the box configurations are not ideal for your current or evolving needs.



Engineered
to manage
a variety of
refrigerated
needs.

Available with
wine racks,
tempered
glass shelves
and chrome-
plated wire
shelves.





A. 15" Full-Extension Shelf Frame

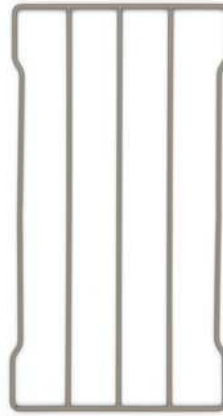

B. 15" Standard (750 ml) Wine Rack Insert



C. 15" Specialty (750 ml) Wine Rack Insert



D. 15" Tempered Glass Shelf Insert

Accessories for 15" Units

Part Number	Material	Description
A 601564	Stainless Steel	15" Full-Extension Shelf Frame
B 617063	Powder Coated Steel	15" Standard (750 ml) Wine Rack Insert
C 617064	Powder Coated Steel	15" Specialty (750 ml) Wine Rack Insert
D 674001	Tempered Glass	15" Tempered Glass Shelf Insert

All specifications are subject to change without notice.



E. 24" Full-Extension Shelf Frame

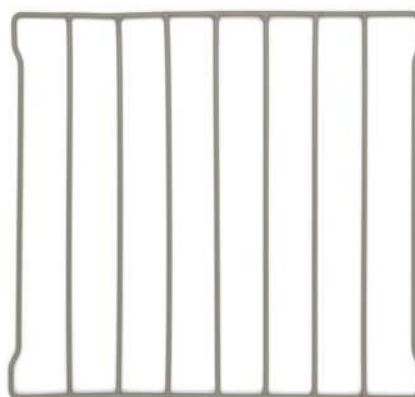

F. 24" Standard (750 ml) Wine Rack Insert

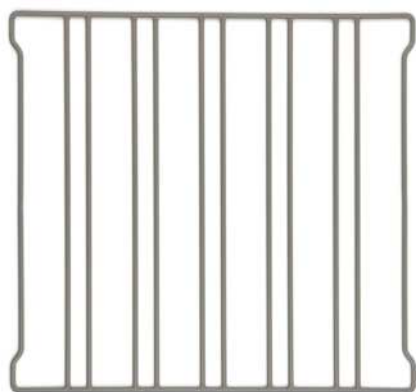

G. 24" Specialty (750 ml) Wine Rack Insert



H. Tempered Glass Shelf Insert



I. 24" Chrome Wire Shelf Insert

Accessories for 24" Units

Part Number	Material	Description
E 601484	Stainless Steel	24" Full-Extension Shelf Frame
F 617059	Powder Coated Steel	24" Standard (750 ml) Wine Rack Insert
G 617060	Powder Coated Steel	24" Specialty (750 ml) Wine Rack Insert
H 674000	Tempered Glass	24" Tempered Glass Shelf Insert
I 617066	Chrome	24" Chrome Wire Shelf Insert
J 601503		Replacement Water Filter, Ice Machine

[Click Link to go to product page website](#)

All specifications are subject to change without notice.

Contact Us

Customer Service: 866.754.6672
SAPPHIRE Appliances | The Legacy Companies
3355 Enterprise Avenue, Suite 160, Fort Lauderdale, FL 33331

email@SAPPHIREappliances.com | SapphireAppliances.com

Limited Warranty

The Legacy Companies warrants to the original purchaser of its SAPPHIRE products that they will be free from defects in materials and workmanship for the following time periods from the date of purchase shown on the sales receipt:

Two (2) Years Parts & On-Site Labor
Five (5) Years Compressor Warranty (Parts Only)

See complete warranty for details.

ALL REPAIRS AND SERVICE MUST BE MADE BY A SAPPHIRE
AUTHORIZED TECHNICIAN.



40 1

34°F

SAPPHIRE



⏪ ⏩ ICE ⏻ ⏹

SAPPHIRE



SapphireAppliances.com | 866.754.6672
SAPPHIRE Appliances | The Legacy Companies
3355 Enterprise Avenue, Suite 160, Fort Lauderdale, FL 33331