

**NICOLOCK**<sup>®</sup>

PAVING STONES • RETAINING WALLS • OUTDOOR LIVING



**SUMMERSET**



# GRILLS



26", 32", 40" SIZZLER  
Shown with Optional Rotisserie Kit



32", 40" SIZZLER PRO  
Shown with Optional Rotisserie Kit



32", 38", TRL / 44" TRLD



THE OVEN



## SIDE BURNERS



SINGLE SIDE BURNER  
SSSB1



SIZZLER DOUBLE SIDE BURNER  
SIZSB2



SIZZLER PRO LIGHTED  
DOUBLE SIDE BURNER  
SIZPROSB2



TRL LIGHTED DOUBLE  
SIDE BURNER  
TRLSB2



SEAR SIDE BURNER  
TRLS5



TRL LIGHTED POWER BURNER  
TRLPB2



## FREE STANDING CARTS



SUMMERSET SIZZLER CART  
CART-SIZ



SUMMERSET SIZZLER PRO CART  
CART-SIZDC



SUMMERSET TRL DELUXE CART  
CART-TRLDC



OVEN CART  
CART-OVEN



## REFRIGERATION



21" 4.5C COMPACT REFRIGERATOR  
SSRFR-21S  
Reversible Door



21" 4.5C DELUXE COMPACT REFRIGERATOR  
SSRFR-21D / SSRFR-21DR  
Available with Right Opening Door



24" 5.3C DELUXE OUTDOOR RATED 2-DRAWER REFRIGERATOR  
SSRFR-24DRZ



24" OUTDOOR RATED DUAL ZONE WINE COOLER  
SSRFR-24W / SSRFR-24WD  
Available in Single Zone



24" 6.6C DELUXE OUTDOOR RATED KEGERATOR (SINGLE / DOUBLE TAP TOWER)  
SSRFR-24DK1 / SSRFR-24DK2



24" 5.3C OUTDOOR RATED REFRIGERATOR  
SSRFR-24S / SSRFR-24SR  
Available with Right Opening Door



24" 5.3C DELUXE OUTDOOR RATED REFRIGERATOR  
SSRFR-24D / SSRFR-24DR  
Available with Right Opening Door



15" OUTDOOR RATED FRIDGE WITH GLASS DOOR  
SSRFR-15G  
Available with Stainless Door



15" OUTDOOR RATED DUAL ZONE WINE COOLER  
SSRFR-15WD  
Available in Single Zone

## ICE CHESTS



17" 1.7C DROP-IN COOLER (20LB ICE CAPACITY)  
SSIC-17



28" 2.7C DROP-IN COOLER (40LB ICE CAPACITY)  
SSIC-28



15" DROP-IN SINK & HOT/COLD FAUCET  
SSNK-15D

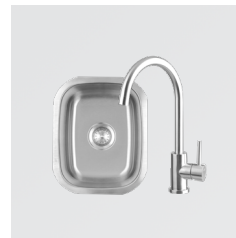

19" UNDERMOUNT SINK & 360° HOT/COLD FAUCET  
SSNK-19U



30" LIGHTED BEVERAGE & PREP STATION  
SSBC-30L

## SINKS AND BAR PREP



# OUTDOOR KITCHEN COMPONENTS

## STORAGE DRAWERS



20" VENTED LIQUID PROPANE TANK OR TRASH DRAWER  
SSDR1-20LP / SSTD1-20



17" DOUBLE DRAWER  
SSDR1-17 / SSDR2-17 / SSDR3-17  
Available as Single and Triple Drawer



26" UTENSIL DRAWER  
SSDR1-26U



17" PAPER TOWEL HOLDER  
SSTH-17



32" DOUBLE HORIZONTAL DRAWER  
SSDR2-32H

## ACCESS DOORS

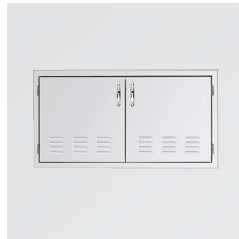

33" VENTED DOUBLE ACCESS DOOR  
SSDD-33V



DOUBLE ACCESS DOOR (26"-45")  
SSDD-26 / SSDD-30 / SSDD-33 / SSDD-36  
SSDD-39 / SSDD-42 / SSDD-45



VERTICAL ACCESS DOOR (16", 18", 20")  
SSDV-16 / SSDV-18 / SSDV-20

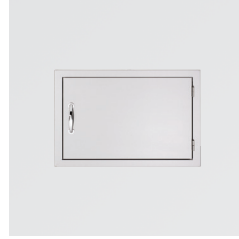

HORIZONTAL ACCESS DOOR  
SSDH-18 / SSDH-22 / SSDH-27

## DOOR/DRAWER COMBOS



2-DRAWER & ACCESS DOOR COMBO (30", 33", 36", 42")  
SSDC2-30" / SSDC2-33" / SSDC2-36" / SSDC2-42"



30" 3-DRAWER & ACCESS DOOR COMBO  
SSDC3-33



30" 2-DRAWER & LP TANK PULLOUT DRAWER COMBO  
SSDC2-33LP



17" VERTICAL 2-DRAWER & PAPER TOWEL HOLDER COMBO  
SSTDC-17

## DRY STORAGE



36" 2-DRAWER DRY STORAGE PANTRY & ENCLOSED CABINET COMBO  
SSDP-36DC



36" 2-DRAWER DRY STORAGE PANTRY & ACCESS DOOR COMBO  
SSDP-36DC



36" WARMING DRAWER  
SSWD-36



# MADERA REAL WOOD COMPONENTS

## MADERA DRY STORAGE

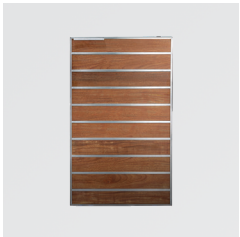

20" MADERA FULL HEIGHT VERTICAL DRY STORAGE PANTRY  
SSMP-20V

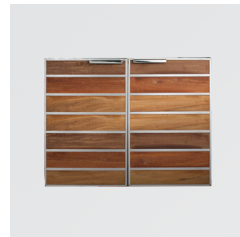

30" MADERA HORIZONTAL DRY STORAGE PANTRY  
SSMP-30DC

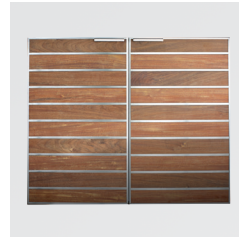

40" MADERA FULL HEIGHT VERTICAL DRY STORAGE PANTRY  
SSMP-40V



## MADERA ACCESS DOORS



30" MADERA DOUBLE ACCESS DOOR  
SSMDD-30

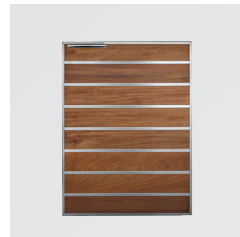

20" MADERA VERTICAL ACCESS DOOR  
SSMDV-20



## MADERA COMBOS

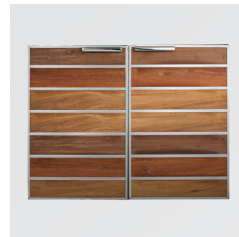

30" MADERA DRY STORAGE 2-DRAWER & ACCESS DOOR COMBO  
SSMDP-30AC



## MADERA DRAWERS

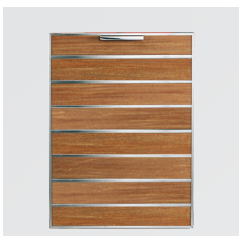

20" MADERA DOUBLE TRASH / RECYCLING 2-BIN PULLOUT DRAWER  
SSMTD2-20



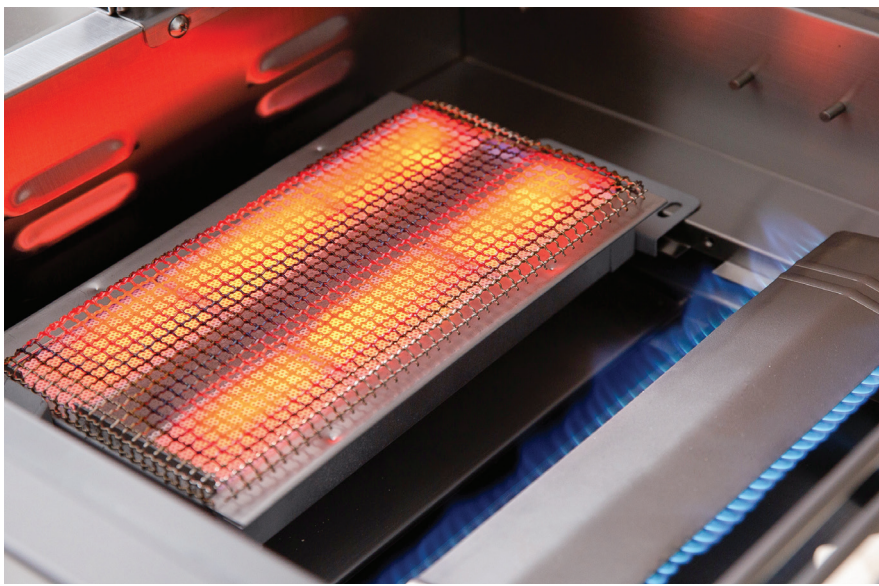

# GRILL AND ISLAND ACCESSORIES

## GRILL & SIDE BURNER LINERS



GRILL LINER  
GL



SIDE BURNER LINER  
GL

## SIZZLER/ SIZZLER PRO SIDE BURNER BRACKET



SIDE BURNER BRACKET  
CART-SIZ-SB2BK

## SEAR BURNERS

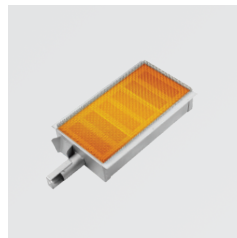

INFRARED SEAR BURNER  
IRB-SIZ / IRB-TRL

## ROTISSERIE KITS



SUMMERSET ROTISSERIE KITS  
ROTKIT

## SMOKER TRAYS



SMOKER TRAYS  
SSMK-SIZ / SSMK-TRL

## GAS TIMER / MOUNTING PLATES

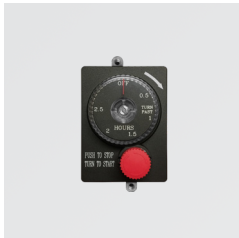

GAS TIMER WITH EMERGENCY SHUTOFF / MOUNTING PLATE  
ESTOP1-0H / ESTOP2-SH

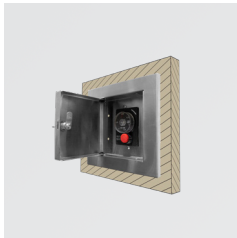

GAS TIMER WITH LOCKING CABINET  
ESTOP-LC-KIT / ESTOP-RM-KIT  
From Super Surface Mount Available



EXPANDABLE MASONRY GAS TIMER KIT  
ESTOP-CP-KIT

## CUTTING BOARD & TRASH CHUTE

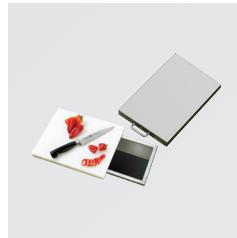

14" TRASH CHUTE & CUTTING BOARD WITH LID  
SSTC-14

## SUMMERSET GRIDDLE



14" SUMMERSET GRIDDLE PLATE  
SSGP-14

# VENT HOODS



VENT HOOD (36", 48", 60")  
SSVH-36 / 48 / 60

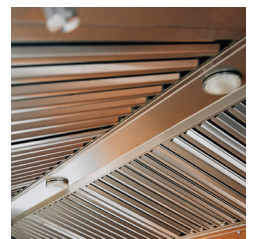

# SUMMERSET'S LIFETIME WARRANTY

Summerset Professional Grills is backed by the strongest warranty in the industry! In addition to precision engineering and outstanding performance, Summerset grill series include a LIFETIME WARRANTY. Now you can use a grill with the peace of mind that you have an industry leading warranty.

## SUMMERSET GRILL SERIES

- Lifetime Warranty on construction and manufacturer defects
- Lifetime Warranty on frame and housing
- Lifetime Warranty on cooking grates, burners and valves
- 1 year Warranty on all other parts, components, and electrical

## COMPONENTS

- Lifetime Warranty on construction, workmanship and materials for all stainless steel components, including doors, drawers, ice chests, beverage centers, sinks and grill liners
- 1 year on all other parts and electrical
- Limited (5 year) Warranty on carts
- Limited (1 year) Warranty on grill covers

## REFRIGERATION

- 2 year warranty on all construction and compressor (SSRFR-21S, SSRFR-21D, SSRFR-21DR, SSRFR-24S, SSRFR-24SR, SSRFR-24W, SSRFR-24WD, SSRFR-15G, SSRFR-15S, SSRFR-15WD, SSRFR-15W)
- 3 year warranty on all construction and compressor (SSRFR-24D, SSRFR-24DR, SSRFR-24DK1, SSRFR-24DK2, SSRFR-24DR2)
- 1 year warranty on all electrical components

## MADERA PRODUCTS

- Lifetime warranty on construction, workmanship and materials for all stainless steel components

# CUTOUTS

For cutouts, dimensions or more information on your Summerset product, visit [Summersetgrills.com/cutouts](http://Summersetgrills.com/cutouts) or scan this QR Code with your smartphone's camera app.

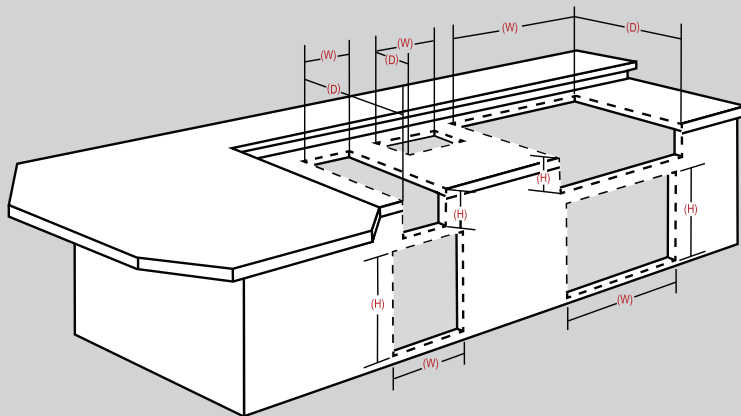

Summerset's Lifetime Warranty is valid for original purchaser at original site of delivery with proof of purchase and photo documentation only. Registration form must be submitted within 30 days of the purchase date to validate the warranty. Warranty is void upon transfer of ownership. Warranty does not apply to products installed in any commercial, rental, or non-residential application. Warranty covers replacement parts only. Manufacturer is not responsible for labor or labor-related costs. Warranty does not cover discoloration, surface rust, corrosion, or oxidation, which may occur due to harsh environments, chemicals, or overheating. Warranty will not apply for damage resulting from improper installations, abuse, extreme environments, grease fires, or misuse. Regular and proper maintenance is required. Coastal, humid, and/or salt environments are subject to manufacturer review. All out-of-box claims must be made within 30 days of purchase and must be made prior to installation. Any product installed damaged will be considered damaged during installation and not covered under warranty. Warranty and registration forms are available at [www.SummersetGrills.com](http://www.SummersetGrills.com). Please be advised - all display models are sold "as is" and the warranty covers the following items only: main burners (Lifetime), grates (Lifetime), burner covers (1 year). All warranties are subject to the review and approval of the manufacturer.