

 SUMMERSET



LET'S GRILL.



We are a family owned and operated business located in beautiful Huntington Beach, California. We pride ourselves in using only the best materials, and our commitment to quality is reflected in the craftsmanship of the entire Summerset line. With over 20 years of leadership in branding and manufacturing, our core focus is to provide exceptional customer service backed by the Summerset Lifetime Warranty.

Summerset Professional Grills strives to meet every outdoor living expression. We offer a wide range of products from grills, refrigeration, sinks, accessories, and more. Our goal is to ensure you have everything you need to create your perfect outdoor atmosphere. No matter the style or budget, Summerset will deliver an experience that will help create the ultimate backyard getaway.



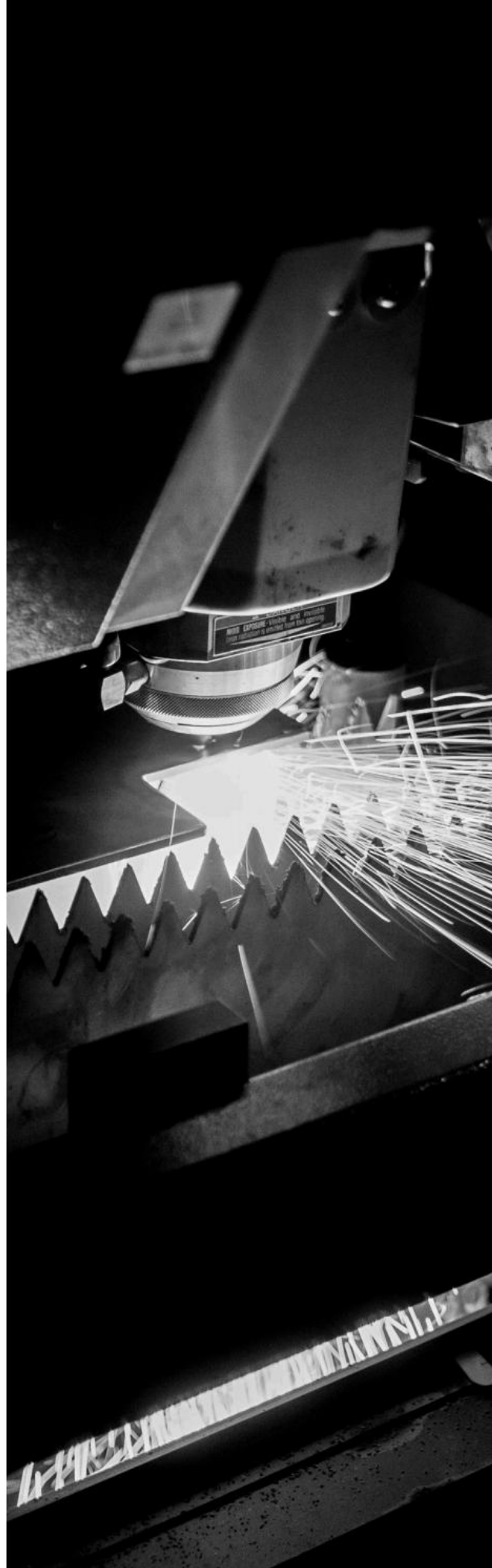

GRILLS

Summerset Professional Grills offers a complete line of commercial grade stainless steel barbecue grills. Whether you're looking for a simple, clean, entry-level grill like our Sizzler, a heavy-duty grill that supports charcoal, lump coal, and wood chunks like the AMG, or something in between—we have it all.



1.



2.

1. AMG 2. AMG 3. SIZ



3.



1.

BURNER TYPES

Bringing quality and maximum horsepower together, our grill lines come equipped with either Stainless Steel Tube and U-Tube Burners, Cast Stainless Burners, or the ultimate Cast Red Brass Burners.

LIGHTING FEATURES

Proper lighting creates drama, style, and function. LED Front Panel Lighting fetches eye-catching flair, while Interior Halogen Lighting provides needed illumination for grilling regardless of the time of day.

INNOVATIONS

Our grills facilitate outdoor living by providing functional and innovative feature sets, such as rotisserie spit holders, built-in drip trays to keep your area clean and safe, and double-lined hoods for durability and maximum heat retention.

STAINLESS STEEL CONSTRUCTION

Our grills are made to weather the elements allowing them to remain the centerpiece of your outdoor kitchen. All Summerset grills and accessories feature high-quality stainless steel, providing durability and are backed by the Summerset Lifetime Warranty.

VERSATILITY

Whether it is fuel choice, built-in or freestanding, size (sleek 26" up to massive 54"), or total BTUs (from 36,000 to 176,000), our grills offer the versatility to maximize every outdoor space. Providing a variety of cooking methods (gas, solid fuels, rotisserie, and infrared) gives you the creative freedom you deserve.



2.

1. AMG 2.TRL 3.SBG





26" SIZZLER



32" SIZZLER



40" SIZZLER

Shown with Optional Rotisserie Kit

SIZZLER

Quality you can afford. The Sizzler Series is a premium product at an unbeatable price. Constructed in all commercial grade stainless steel and designed with careful precision to ensure optimal airflow and even heating, this grill gives its higher-priced competitors a run for their money in both durability and grilling performance. The Sizzler will impress the most discriminating of grillers.

FEATURES

- Commercial Grade Stainless Steel
 - Double-Lined Hood
 - 8mm Cooking Grates
 - 12,000 BTU Stainless Tube Burners
 - 15,000 BTU IR Back Burner*
 - Flame Thrower Ignition
 - Manual Flash Tube Ignition
 - Easy-Clean Briquette System
 - Built-In and Cart Models Available
 - Matching Side Burner Available
 - Side Burner Cart Bracket Available
 - Rotisserie Kits Available
 - 15,000 BTU Drop-In Sear Burner Available
 - 14,000 BTU Cast Stainless Burners Available
- *Excludes 26" Sizzler

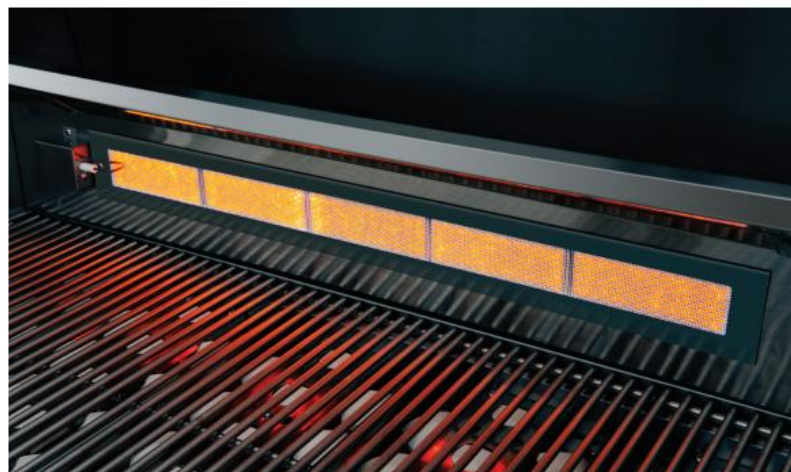
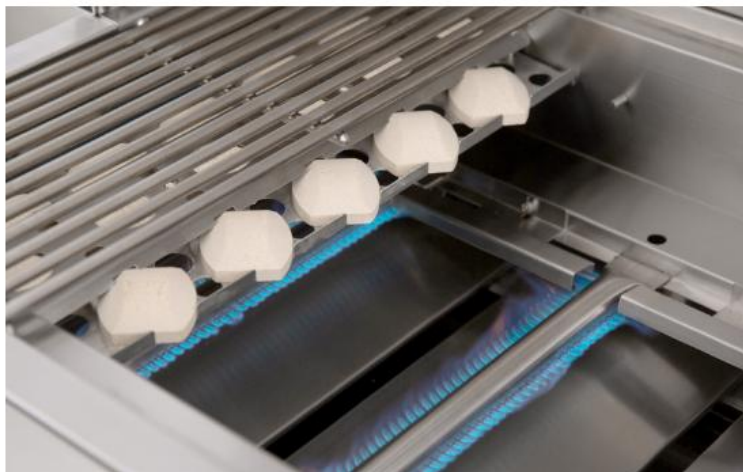



32" SIZZLER PRO



40" SIZZLER PRO

Shown with Optional Rotisserie Kit

SIZZLER PRO

The Sizzler Pro Series combines features, quality construction, and affordability. Based on the same sleek design of our classic Sizzler, with the addition of interior and exterior lighting, 14,000 BTU cast burners and heat zone separators, this grill really sets itself apart. The best part is... it won't break your wallet.

FEATURES

- Commercial Grade Stainless Steel
- Double-Lined Hood
- 8mm Cooking Grates
- 14,000 BTU Cast Stainless Burners
- 15,000 BTU IR Back Burner
- Heat Zone Separators
- Exterior LED Lighting
- Interior Cooking Lights
- Flame Thrower Ignition
- Manual Flash Tube Ignition
- Easy-Clean Briquette System
- Built-In and Cart Models Available
- Matching Side Burner Available
- Side Burner Cart Bracket Available
- Rotisserie Kits Available
- 15,000 BTU Drop-In Sear Burner Available

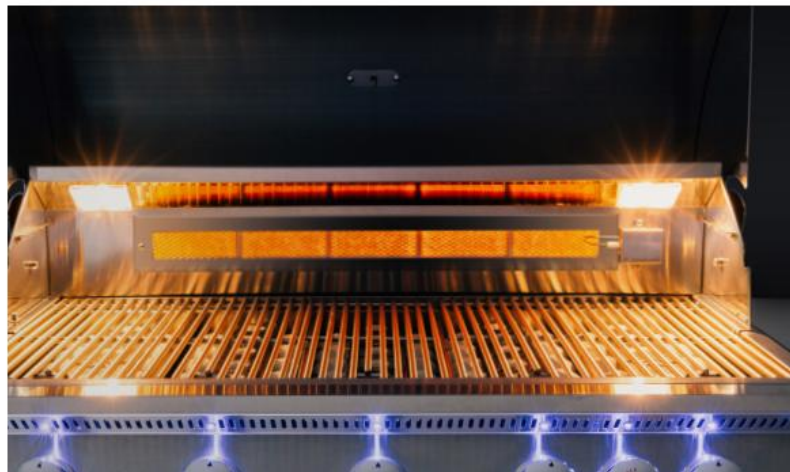
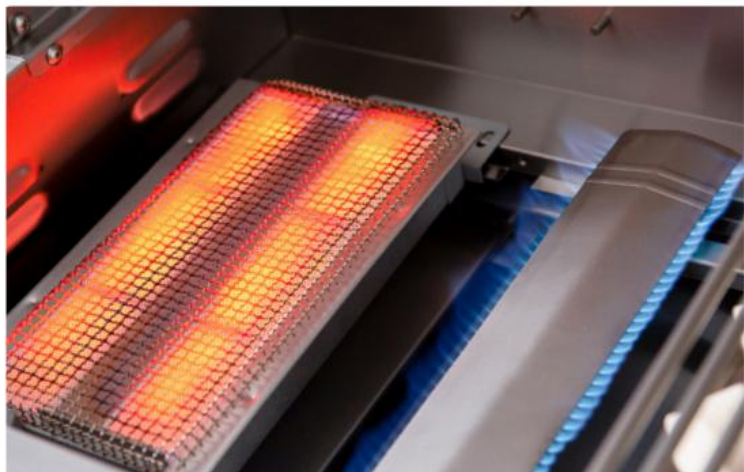



32" TRL



38" TRL



44" TRLD

TRL/TRLD

The TRL is a fully loaded workhorse, a grilling classic packed with luxury features. Complete with interior lights, exterior LEDs, rear infrared burner, rotisserie set, flame thrower valves, easy-clean briquette burner covers, and plug-and-play infrared sear zone options, the TRL makes professional grilling easy. With #304 stainless steel exterior construction and 16-gauge stainless steel burners backed by the Summerset Lifetime Warranty, this grill is built to last.

FEATURES

- #304 Stainless Steel Exterior Construction
- Double-Lined Hood
- 8mm Cooking Grates
- 18,000 BTU #304 Stainless Burners
- 15,000 BTU IR Back Burner
- Flame Thrower Ignition
- Exterior LED and Interior Halogen Lighting
- Easy-Clean Briquette System
- Rotisserie Kit Included
- Heat-Zone Separators
- 18,000 BTU Drop-In Sear Burner Available
- Built-In and Cart Models Available
- Matching Sear Side Burner Available
- Matching Double Side Burner Available
- 20,000 BTU Cast Stainless Burners Available

TRLD ADDED FEATURES

- 20,000 BTU Cast Stainless Burners
- Heavy-Duty 9mm Cooking Grates

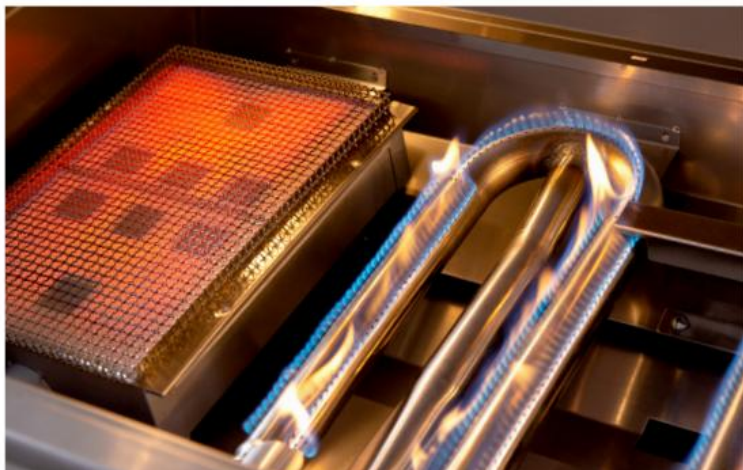

PHOTO: EQUITEST PREMIUM FABRICATION



BUILDER GRILL

The Summerset Builder Grill has been specially designed to accommodate all types of multi-family and commercial applications. Whether it is an apartment community, hotel, or country club, these environments get a great deal of extra use. Donning the same beefed-up body as our luxury Alturi series, the Builder Grill is made with Commercial Grade stainless steel construction, 9mm cooking grates, and extra thick 14-gauge stainless steel burner covers. Available in both built-in and pedestal models, this grill is the perfect option for any commercial application.



30" BUILDER GRILL

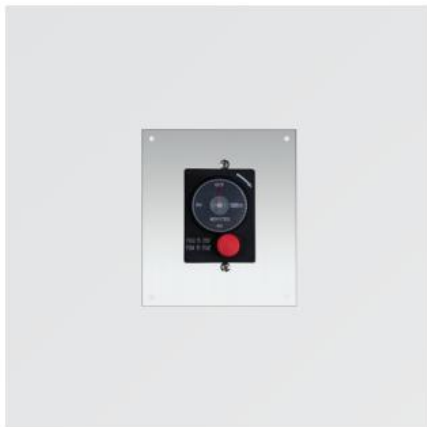

GAS TIMER WITH EMERGENCY SHUTOFF / MOUNTING PLATE

FEATURES

- #304 Stainless Steel
- Double-Lined Hood
- Heavy-Duty 9mm Cooking Grates
- 26,000 BTU #304 Stainless Burners
- Flame Thrower Ignition
- Heavy-Duty 14-Gauge Flame Tamers
- Locking Drip Tray
- Heavy-Duty Anti-Theft Knobs
- LP Conversion Kit Included
- Built-In and Pedestal Models Available
- Timer Panel Sold Separately
- Built, Factory Tested, and Serviced in the USA.







30" ALTURI



36" ALTURI

Shown with Optional Wood Handle



42" ALTURI

ALTURI

The Alturi Series can be summed up in one word: luxury. Designed with elegance, made in the U.S., fueled with power, and loaded with every feature, this grill sets the bar for luxury outdoor cooking. Details like the angle-mounted interior lights, rotisserie storage, and spring-assisted hood provide ultimate convenience, while its #304 stainless steel construction and high BTU Red Brass burners—the most durable on the market—guarantee lasting performance. When it comes to quality, style, and functionality, Alturi truly stands alone.

FEATURES

- #304 Stainless Steel
- Double-Lined Hood w/ Spring Assist
- Heavy-Duty 9mm Cooking Grates
- 26,000 BTU Red Brass Main Burners
- 15,000 BTU IR Back Burner
- Interior Halogen Lighting
- LED Front Panel Lighting
- Heat Zone Separators
- Easy-Clean Briquette System
- Flame Thrower Ignition
- 100lb Motor with Rotisserie Kit Included
- 26,000 BTU Drop-In Sear Burner Available
- Matching Sear Side Burner Available
- Matching Double Side Burner Available
- Built-In and Cart Models Available
- #304 Stainless Tube Burners Available
- Wood Handle Available
- Built, Factory Tested, and Serviced in the USA.



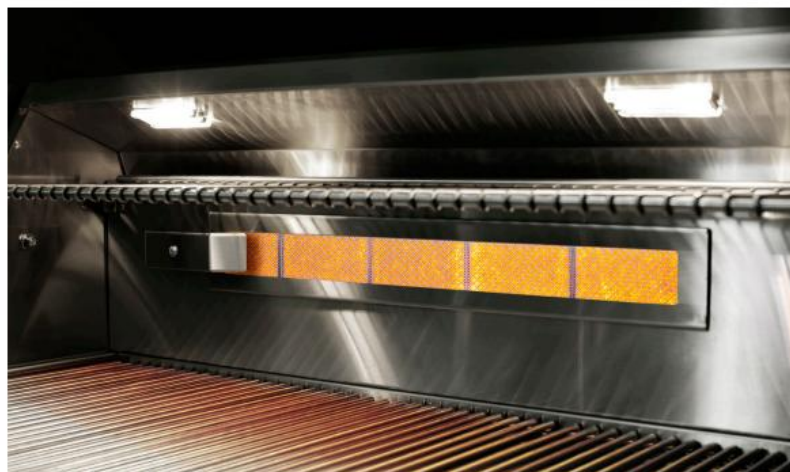



36" AMG



54" AMG

AMERICAN MUSCLE GRILL

We can argue all day about the convenience and consistency of gas vs. the bold flavor of charcoal. Why don't we put an end to the argument and just burn it all? Leave indecision at the door and rev-up this multi-fuel monster, enjoying the perks of gas, charcoal, wood chunks, infrared, or all of them at the same time—all in a single BBQ. Use your gas to ignite the solid fuels in just seconds, or don't. The choice is yours when you have the best of both worlds at your fingertips. With 36" and 54" models, the biggest decision you'll be left to make is how big you want it—big, or BIG.

FEATURES

- #304 Stainless Steel Construction
- 16-Gauge Double-Lined Hood with Spring-Assist
- Full-Width Hood Handle
- Hood Vents for Heat Control
- Solid Brass, Flame Thrower Valve Ignition
- 22,000 BTU Main Burners
- 14-Gauge #304 Stainless Steel Burners
- 12-Gauge #304 Burner Covers
- Reversible 9-Gauge V-Shaped Grates for Cooking

Versatility

- Multi-Fuel Capability
- Patented 12-Gauge Solid Fuel Trays
- Grate Lifting Tool For Solid Fuel Refilling
- High Efficiency Interior Cooking Lights
- LED Lights Over Each Knob
- Easy-Clean Drip Pan with Drain System
- Built-In Rotisserie Spit Storage
- Tested to the ANSI Z21.58/ CGA 1.6
- Includes AMG Leather Gloves
- Includes Grill Cover
- Built, Factory Tested, and Serviced in the USA.





SIDE & POWER BURNERS

Here we've combined the comfort of an indoor kitchen range with all the benefits of being outside. Specially designed for performance and function, a Summerset side burner is the perfect addition to your outdoor kitchen. Commonly used for finish cooking, sauces, or heating foods that require lower, more controlled temperatures than your grill, a side burner offers the convenience of range top cooking and grilling simultaneously. Find the perfect side burner for your outdoor kitchen with five professional lines to choose from: Sizzler, Sizzler Pro, TRL, Alturi, and AMG. All Summerset side burners feature stainless steel construction, heavy stainless steel grates, and up to 60,000 BTUs of power—all packed in a sleek design and backed by the Summerset Lifetime Warranty.

FEATURED
- AMG Power Burner









SINGLE SIDE BURNER

SSSB1

Total BTUs: 15,000
Cooking Surface: 9^{1/2} x 9^{1/2}

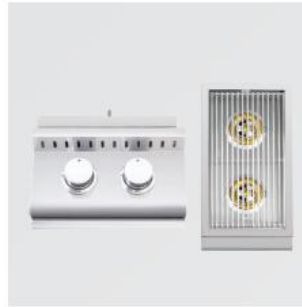

SIZZLER DOUBLE SIDE BURNER

SIZSB2

Total BTUs: 24,000
Cooking Surface: 19^{1/2} x 10^{1/2}



SIZZLER PRO LIGHTED DOUBLE SIDE BURNER

SIZPROSB2

Total BTUs: 24,000
Cooking Surface: 19^{1/2} x 10^{1/2}
Front Panel LED Lighting



TRL LIGHTED DOUBLE SIDE BURNER

TRLSB2

Total BTUs: 30,000
Cooking Surface: 19^{1/2} x 11^{1/2}
Front Panel LED Lighting



TRL SEAR SIDE BURNER

TRLSS

Total BTUs: 26,000
Infrared Burner (Up to 1600°F)
Adjustable High/Low Technology
Cooking Surface: 18^{1/2} x 11^{1/2}



ALTURI LIGHTED DOUBLE SIDE BURNER

ALTSB2

Total BTUs: 35,000
Solid Brass Burners
Cooking Surface: 21^{1/2} x 11^{1/2}
Front Panel LED Lighting



ALTURI LIGHTED SEAR SIDE BURNER

ALTSS

Total BTUs: 26,000
Infrared Burner (Up to 1600°F)
Adjustable High/Low Technology
Cooking Surface: 21^{1/2} x 11^{1/2}
Front Panel LED Lighting



TRL LIGHTED POWER BURNER

TRLPB

Total BTUs: 60,000
Cooking Surface: 13^{1/2} x 17^{1/2}
Cast Stainless Steel Dual Ring Burner
Removable Center Grate for Wok Cooking
Front Panel LED Lighting



AMG LIGHTED POWER BURNER

AMGPB

Total BTUs: 60,000
Cooking Surface: 13^{1/2} x 17^{1/2}
Cast Stainless Steel Dual Ring Burner
Removable Center Grate for Wok Cooking
Front Panel LED Lighting

FREE- STANDING CARTS

Summerset Professional Grills' complete line of grill carts offer a premium alternative to built-in models. Constructed of the highest quality stainless steel and manufactured in the USA, Summerset's durable carts offer stability, storage and convenience for casual and professional chefs alike.

FEATURED

- 54" AMG
- 54" AMG Cart







SUMMERSET SIZZLER CART

CART-SIZ

- Commercial Grade Stainless Steel
- Magnetic Double Access Door
- Front Locking Caster Wheels
- Interior Paper Towel Holder
- Propane Tank Storage
- Side, Rear and Bottom Ventilation
- Made in America



SUMMERSET SIZZLER PRO CART

CART-SIZDC

- Commercial Grade Stainless Steel
- Magnetic Access Door with 2-Drawer Storage
- Front Locking Caster Wheels
- Interior Paper Towel Holder
- Propane Tank Storage
- Side, Rear and Bottom Ventilation
- Fully Assembled
- Made in America



SUMMERSET TRL CART

CART-TRL

- Commercial Grade Stainless Steel
- Magnetic Double Access Door
- Front Locking Caster Wheels
- Interior Paper Towel Holder
- Propane Tank Storage
- Side, Rear and Bottom Ventilation
- Made in America



SUMMERSET TRL/D CART

CART-TRLDC

- Commercial Grade Stainless Steel
- Magnetic Access Door with 2-Drawer Storage
- Front Locking Caster Wheels
- Interior Paper Towel Holder
- Propane Tank Storage
- Side, Rear and Bottom Ventilation
- Fully Assembled
- Available for TRL Models
- Made in America









SUMMERSET BUILDER GRILL PEDESTAL

SBG30-PED

- Commercial Grade Stainless Steel
- Locking Double Door
- Propane Tank Storage
- Side, Rear and Bottom Ventilation
- Fully Assembled
- CART-PED Also Available with Wheels
- Timer Available
- Made in America



SUMMERSET ALTURI CART

CART-ALT

- Commercial Grade Stainless Steel
- Magnetic Access Door with 2-Drawer Storage
- Locking Caster Wheels
- Interior Door Condiment Tray
- Propane Tank Storage
- Side, Rear and Bottom Ventilation
- 30" Model Features Double Access Doors
- Fully Assembled
- Made in America



AMERICAN MUSCLE GRILL CART

CART-AMG

- Commercial Grade Stainless Steel
- Storage Drawers with Interior Stainless Steel Fuel Dividers
- Tank Pullout Drawer and Double Utility Drawer Storage
- Folding Shelf
- Cutting Board
- Cart Handle & Towel Holder
- Locking and Non-Locking Caster Wheels
- Side, Rear and Bottom Ventilation
- 36" Model Available with Single Fuel Storage Drawer
- Fully Assembled
- Made in America



COLD STORAGE

Enjoy fresh ingredients and chilled beverages with Somerset Professional Grills' full line of cold storage products. All Somerset refrigeration offers durable construction for the outdoors, temperature control, adjustable legs for leveling, and sleek design for function and beauty. Bring the sophistication of your indoor refrigeration systems outside with matching performance and design.

FEATURED

- Lighted Beverage Center
- 36" Double Door





REFRIGERATION

Summerset offers a wide variety of luxury stainless steel refrigerators. With up to 5.3 cubic feet of storage, these appliances will help keep your food fresh, wine chilled, and beer cold, bringing the function of your indoor refrigeration outside to join the party!



21" 4.5C COMPACT REFRIGERATOR

SSRFR-21S

- #304 Stainless Steel Door Construction
- Storage Capacity: 4.5 ft³
- Locking Door w/Reversible Door Capability
- Rear Venting



21" 4.5C DELUXE COMPACT REFRIGERATOR

SSRFR-21D / SSRFR-21DR

- #304 Stainless Steel Door Construction
- Storage Capacity: 4.5 ft³
- Left and Right Doors Available
- Rear Venting



24" 5.3C OUTDOOR RATED REFRIGERATOR

SSRFR-24S / SSRFR-24SR

- #304 Stainless Steel Door Construction
- Storage Capacity: 5.3 ft³
- UL Rated for Outdoor Use
- Locking Door
- Front Venting
- Left and Right Doors Available



24" 5.3C DELUXE OUTDOOR RATED REFRIGERATOR

SSRFR-24D / SSRFR-24DR

- All #304 Stainless Steel Construction
- Storage Capacity: 5.3 ft³
- UL Rated for Outdoor Use
- Locking Door
- Front Venting
- Left and Right Doors Available







24" 6.6C DELUXE OUTDOOR RATED
KEGERATOR (SINGLE TAP TOWER)

SSRFR-24DK1

- Storage Capacity: 6.6 ft³
- UL Rated For Outdoor Use
- #304 Stainless Steel Construction
- Locking Door
- Top Guard Rail Sold Separately
- Front Venting



24" 6.6C DELUXE OUTDOOR RATED
KEGERATOR (DOUBLE TAP TOWER)

SSRFR-24DK2

- Storage Capacity: 6.6 ft³
- UL Rated For Outdoor Use
- #304 Stainless Steel Construction
- Locking Door
- Top Guard Rail Sold Separately
- Front Venting



24" 5.3C DELUXE OUTDOOR RATED 2-DRAWER
REFRIGERATOR

SSRFR-24DR2

- Storage Capacity: 5.3 ft³
- UL Rated For Outdoor Use
- #304 Stainless Steel Construction Drawers
- Two Drawer
- Front Venting



24" 5.3C DELUXE OUTDOOR RATED
WINE COOLER

SSRFR-24DWC

- Storage Capacity: 5.3 ft³
- UL Rated For Outdoor Use
- #304 Stainless Steel Door Construction
- Tinted Glass
- Locking Door
- 54 Bottle Capacity
- Front Venting

SINKS AND BAR PREP

Take your outdoor kitchen to the next level with the Summerset Beverage Center and selection of drop-in sinks. Complete with an ice compartment, sink, towel holder, speed rail with condiment tray, and built-in bottle opener, the Beverage Center will make you the best host in the neighborhood. Don't worry, when the sun goes down the LEDs will light it up and keep the party going!



15" DROP-IN SINK & HOT/COLD FAUCET
SSNK-15D



19" UNDERMOUNT SINK & 360° HOT/COLD FAUCET
SSNK-19U



30" LIGHTED BEVERAGE & PREP STATION
SSBC-30L

ICE CHESTS

With our grills heating things up, we have just what you need to keep cool. Choose between two sizes to optimize your serving station. With up to 40 lbs. of ice capacity, load 'em up with refreshments, snacks, or ingredients to make for a good time.



17" 1.7C DROP-IN COOLER
(20LB ICE CAPACITY)
SSIC-17



28" 2.7C DROP-IN COOLER
(40LB ICE CAPACITY)
SSIC-28



OUTDOOR KITCHEN COMPONENTS

Summerset's full line of outdoor kitchen components features a heavy-duty flange and soft closing drawers. Double-lined construction provides the extra insulation and resilience needed against the elements, and a thicker flange provides a sturdy, seamless fit and elegant style that will work with any countertop and island finish. Soft closures bring the luxury of an indoor kitchen to the outdoor space. Summerset components also feature commercial grade stainless steel construction, magnetic latch, smooth gliding drawers on heavy-duty tracks, and the Summerset Lifetime Warranty. Plus, all access doors feature reversible door mounting to meet your specific needs. Sleek and intuitive, Summerset components provide an integrated solution that can be personalized to any space.

FEATURED

- Summerset 2-Drawer & Access Door Combo

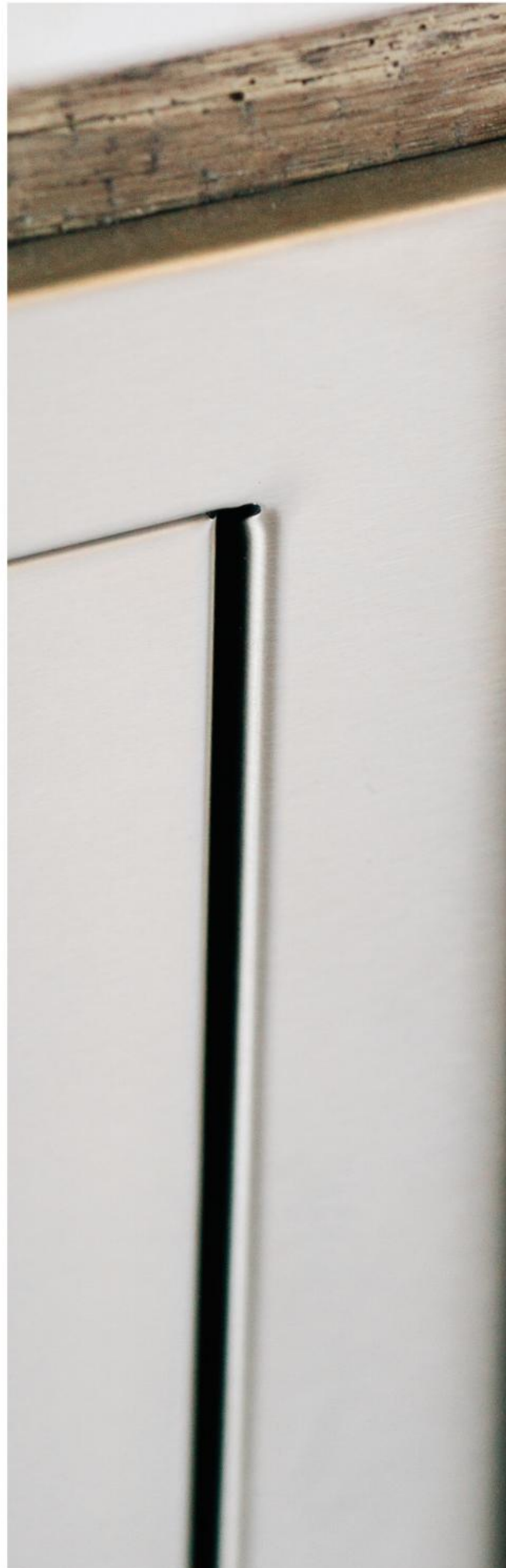



ACCESS DOORS

Summerset's access doors give you an elegant and convenient access to your island, utilities, and grill. Made with commercial grade stainless steel, heavy-duty flanges, reversible door mounting, and magnetic latches.



33" VENTED DOUBLE ACCESS DOOR
SSDD-33V

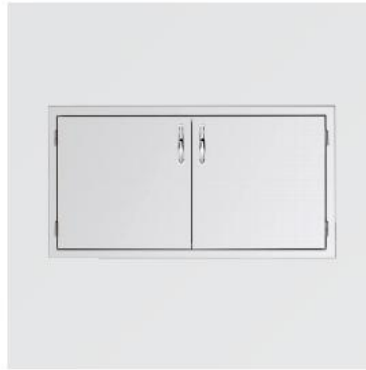

DOUBLE ACCESS DOOR (26"-45")
SSDD-26 / SSDD-30 / SSDD-33 / SSDD-36 /
SSDD-39 / SSDD-42 / SSDD-45



36" AMG DOUBLE ACCESS DOOR
SSDD-36AMG



VERTICAL ACCESS DOOR
(16", 18", 20")
SSDV-16 / SSDV-18 / SSDV-20



HORIZONTAL ACCESS DOOR
SSDH-18 / SSDH-22 / SSDH-27

DOOR/DRAWER COMBOS

These components are specifically designed with versatility in mind. Whether you need a simple storage setup, LP tank drawer, paper towel holder, or weather-resistant dry storage shelving, these commercial grade stainless steel combos give you the options you need for a perfect outdoor setup.



2-DRAWER & ACCESS DOOR
COMBO (30", 33", 36", 42")
SSDC2-30" / SSDC2-33" / SSDC2-36" /
SSDC2-42"



30" 3-DRAWER & ACCESS
DOOR COMBO
SSDC3-33



AMG HANDLES SHOWN





30" 2-DRAWER & LP TANK PULLOUT
DRAWER COMBO
SSDC2-33LP



17" VERTICAL 2-DRAWER & PAPER
TOWEL HOLDER COMBO
SSTDC-17

STORAGE DRAWERS

Summerset's line of drawers are feature-packed storage options that ensure you get exactly what you need in your backyard set up. Made with commercial grade stainless steel, these drawers feature heavy-duty flanges and soft closing drawers.



17" SINGLE DRAWER
SSDR1-17



17" DOUBLE DRAWER
SSDR2-17



17" TRIPLE DRAWER
SSDR3-17



20" VENTED LIQUID PROPANE TANK
OR TRASH DRAWER
SSDR1-20LP



20" TRASH PULLOUT DRAWER
SSTD1-20



20" TRASH & RECYCLING 2-BIN
PULLOUT DRAWER
SSTD2-20



17" PAPER TOWEL HOLDER
SSTH-17



26" UTENSIL DRAWER
SSDR1-26U



36" WARMING DRAWER
SSWD-36



32" DOUBLE HORIZONTAL DRAWER
SSDR2-32H







DRY STORAGE

Summerset's line of dry storage pantries is a solution that offers heavy-duty weather-resistant seals to give you peace of mind year-round—that means moisture and critters are locked out for good. Made with only the highest quality commercial grade stainless steel, these pantries feature heavy-duty flanges and magnetic latches.



36" 2-DRAWER DRY STORAGE PANTRY & ENCLOSED CABINET COMBO
SSDP-36DC



36" 2-DRAWER DRY STORAGE PANTRY & ACCESS DOOR COMBO
SSDP-36AC



36" AMG EXTRA LARGE STORAGE DRAWER
SSDR1-36AMG

MASONRY COMPONENTS

Summerset's line of Masonry Components are perfect for islands with stone or brick finishes. The increased flange depth makes for a seamless fit and streamlined installation. These commercial grade stainless steel components can also be used to add an attractive contrast to any island with stucco or Ameristone finishes.



MASONRY VERTICAL
ACCESS DOOR
SSDV-20M



MASONRY HORIZONTAL
ACCESS DOOR
SSDH-27M



MASONRY DOUBLE ACCESS DOOR
**SSDD-30M / SSDD-33M / SSDD-36M /
SSDD-42M / SSDD-45M**



20" MASONRY TRASH & LP TANK
PULLOUT DRAWER
SSTD1-20M



17" MASONRY DOUBLE DRAWER
SSDR2-17M



17" MASONRY VERTICAL 2-DRAWER
& PAPER TOWEL HOLDER COMBO
SSTDC-17M



MASONRY 2-DRAWER & ACCESS
DOOR COMBO
SSDC2-33M

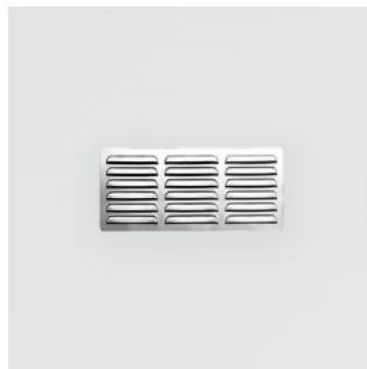

12" MASONRY ISLAND VENT PANEL
SSIV-12M



ALL MASONRY FEATURES 1.25"
FLANGE RETURN AS SHOWN

MADERA REAL WOOD COMPONENTS

The all-new Madera series combines the modern elegance of high-end interior design with the rustic appeal of a natural, outdoor environment. Offering a chic new take on the traditional backyard aesthetic, the weather-resistant dry storage features high-grade North American #304 stainless steel and sustainably sourced teak or ipe wood options. Double-lined construction provides extra insulation and resilience against harsh environments, and weather-resistant seals keep moisture and critters out. Madera's functional design extends to soft closing hinges, smooth gliding tracks, and magnetic latches, all backed by the Summerset Lifetime Warranty. The patent-pending design allows you to remove your wood slats for staining, oiling, cleaning, and further customization. The 100% American made Madera series is sure to bring any outdoor environment to life.

FEATURED

- 38" TRL
- 20" Madera Double Trash / Recycling 2-Bin Pullout Drawer
- 30" Madera Horizontal Dry Storage Pantry
- 20" Madera Full Height Vertical Dry Storage Pantry







FEATURES

The Madera series relentlessly delivers in quality and performance while appearing effortless and tranquil.

#304 STAINLESS STEEL

Durability and beauty have made #304 stainless steel the most appealing grade on the market. This alloy is extremely durable, temperature resistant, and provides a beautiful finish.

CUSTOMIZABLE DESIGN

Each Madera product is designed to be personalized and tailored. Select from our certified, sustainable teak or ipe or choose your own wood, such as mahogany, or even pine.

PATENT-PENDING CONSTRUCTION

Original and durable, each component is engineered with innovation, built to last with top-notch craftsmanship, and backed by the Summerset Lifetime Warranty.

ECO-FRIENDLY, TREATED TEAK AND IPE OPTION

Bring warmth and serenity to your outdoor island with beautiful teak or ipe wood, pretreated to withstand the elements and sourced from environmentally safe sources.

DESIGNER CABINET HINGES

Each Madera cabinet features designer-grade hinges for maximum strength, function, and style. Sleek and engaging, these often unseen details are inspiring and demand attention.

WEATHER-RESISTANT SEAL

Providing longevity and peace of mind through all the seasons, each component features a weather-resistant seal to keep your island dry, clean, fresh and maintained.

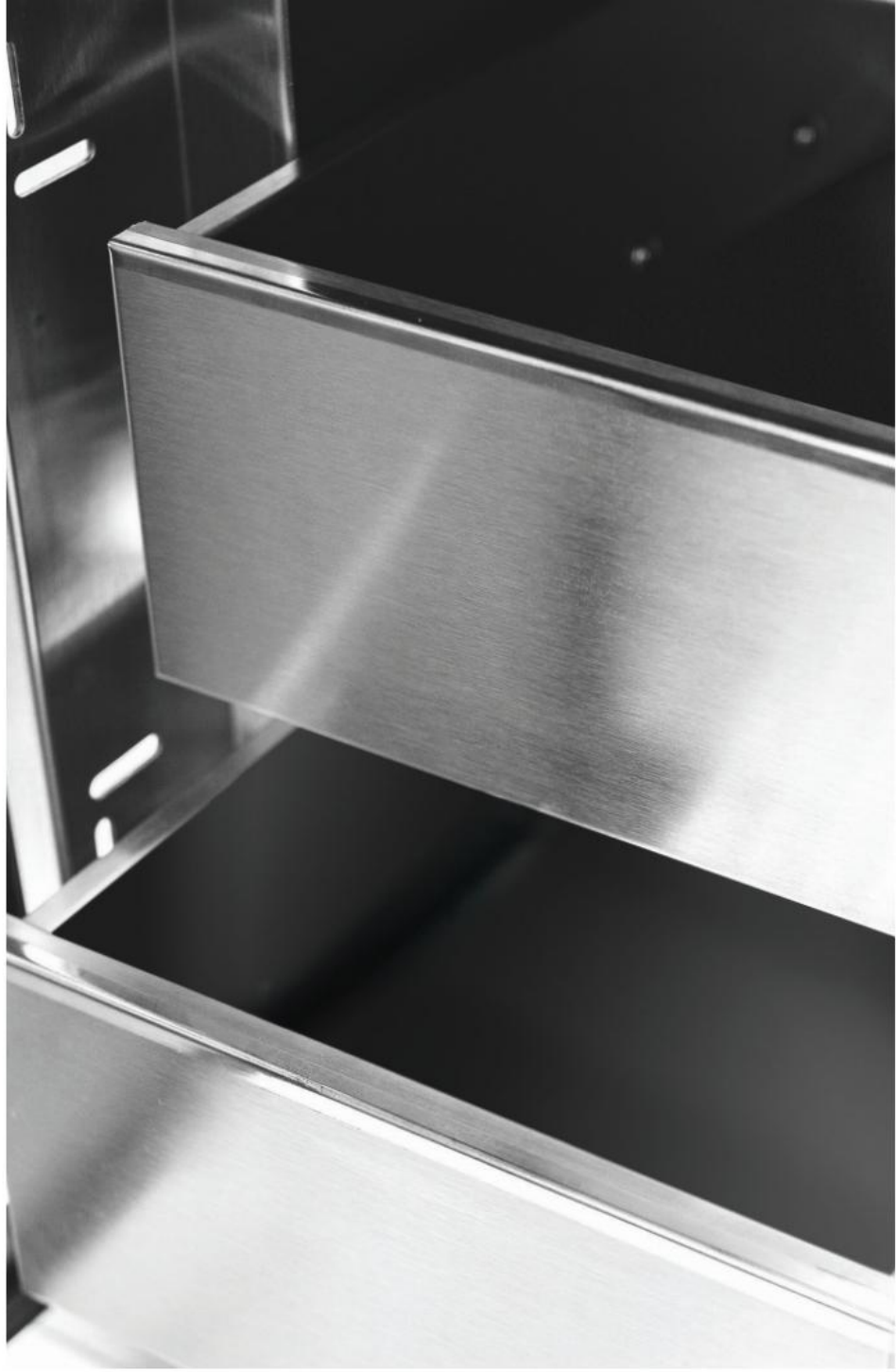

MADERA DRY STORAGE

Madera dry storage pantries keep your outdoor kitchen and supplies organized with multiple configurations to fit your island. Fully enclosed to keep moisture out, and available in teak and ipe, these cabinets offer amazing utility with matching style.



20" MADERA FULL HEIGHT VERTICAL
DRY STORAGE PANTRY
SSMP-20V



40" MADERA FULL HEIGHT VERTICAL
DRY STORAGE PANTRY
SSMP-40V



30" MADERA HORIZONTAL
DRY STORAGE PANTRY
SSMP-30DC







MADERA ACCESS DOORS

Madera access doors offer convenient access to your island, utilities, and grill, with matching style and warmth, and are available in teak and ipe. With a stainless steel flange, these doors can be easily implemented into any design.

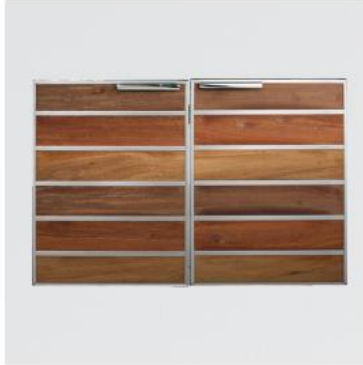

30" MADERA DOUBLE
ACCESS DOOR
SSMDD-30

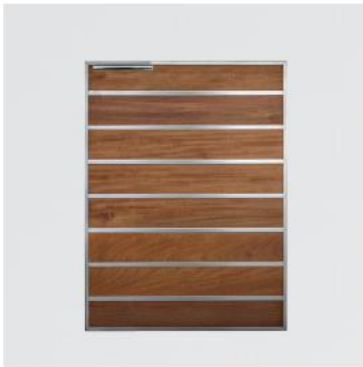

20" MADERA VERTICAL
ACCESS DOOR
SSMDV-20



RECYCLE & TRASH DRAWER

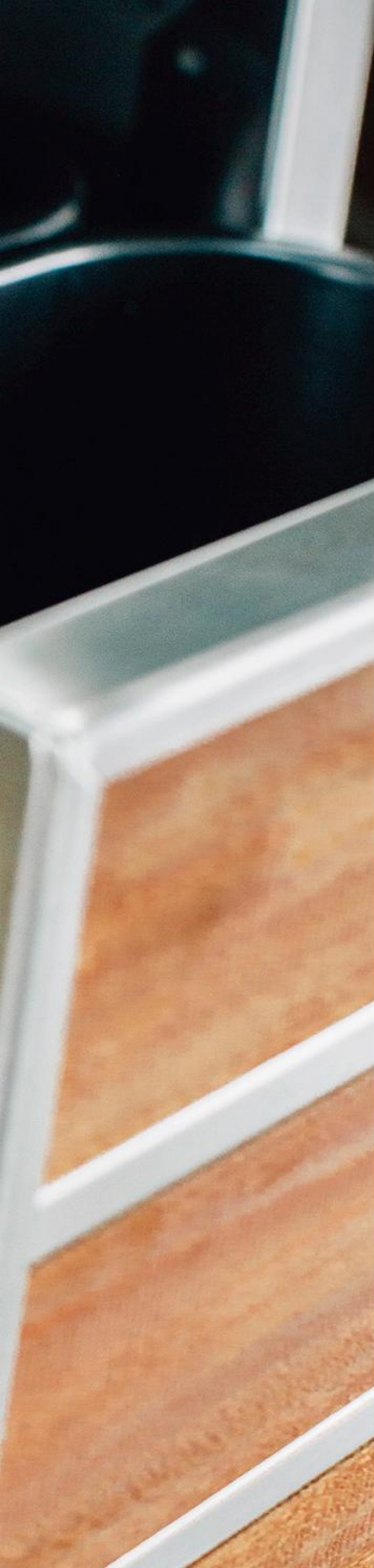

MADERA COMBOS

Madera combos bring the ultimate in customized storage solutions while maintaining the unified organic look. Combining the features of the dry storage cabinets and access doors into one space, the combos are ideal in smaller islands and are available in teak and ipe.

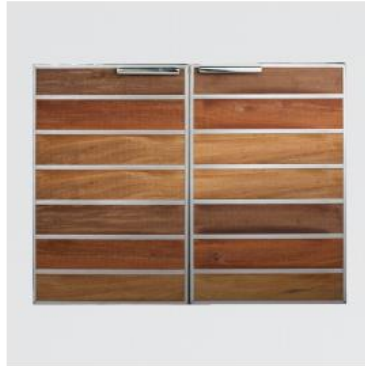

30" MADERA DRY STORAGE
2-DRAWER & ACCESS DOOR COMBO
SSMDP-30AC

MADERA DRAWERS

Madera drawers provide function and convenience for your outdoor kitchen, with stylish teak and ipe giving you the option to customize. All drawers are manufactured fully enclosed with durable, weather-resistant seals and double-lined construction for maximum protection from the outdoors.

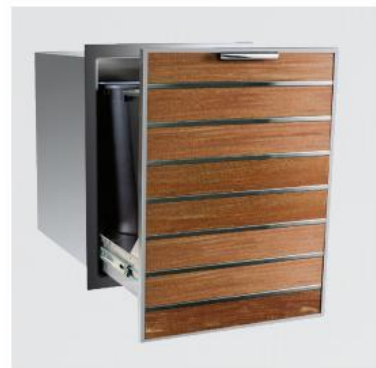
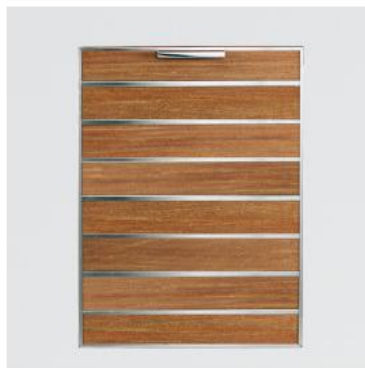

20" MADERA DOUBLE TRASH /
RECYCLING 2-BIN PULLOUT DRAWER
SSMTD2-20

GRILL AND ISLAND ACCESSORIES

Make your kitchen the way you want it... Summerset offers a variety of miscellaneous conveniences, upgrades, and appliances to customize your outdoor space to your liking. All products feature high-grade #304 stainless steel construction for durability and performance.

FEATURED
- AMG Griddle

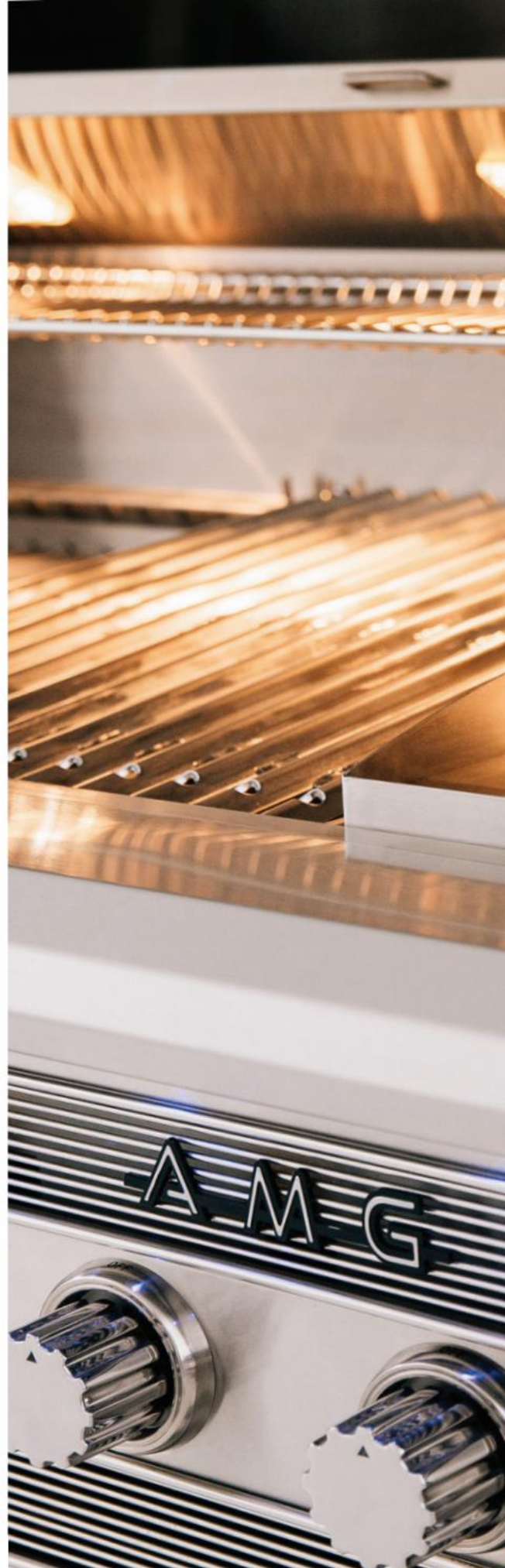



SEAR BURNERS

Become the chef you've dreamed of by using Summerset Sear Burners. Our sear burners can replace nearly any burner position, giving you a customizable cooking experience and allowing you to burn and turn the way you want.



SIZZLER INFRARED SEAR BURNER
IRB-SIZ



TRL INFRARED SEAR BURNER
IRB-TRL

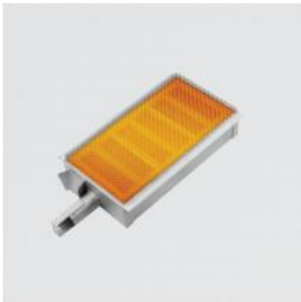

ALTURI INFRARED SEAR BURNER
IRB-ALT



AMG INFRARED SEAR BURNER
IRB-AMG

GRILL & SIDE BURNER LINERS

Summerset Grill Liners are designed with #304 stainless steel construction to protect any outdoor kitchen made of combustible material. The fitted Grill Liners provide an inch of double-walled insulation that blocks the heat from reaching combustible surfaces or framing such as wood or plastic, giving you the freedom to create your outdoor kitchen in the material of your choice.



GRILL LINER
GL



SIDE BURNER LINER
GL

ISLAND ACCESSORIES

For a sleek and well finished outdoor kitchen, count on us to pay attention to even the smallest of details. Trim your refrigerator cutout, seal your umbrella hole and ventilate in style with Summerset's stainless steel accessories. Finishing touches make luxury islands!



SUMMERSET REFRIGERATOR TRIM 21" / 24" SERIES
SSRTK-21 / SSRTK-24



14" NORTH AMERICAN STAINLESS STEEL ISLAND VENT PANEL
SSIV-14 / SSIV-12M



1.75" / 2" UMBRELLA COUNTERTOP MOUNTING STANCHION
SSUS-1 / SSUS-1L

SUMMERSET GRIDDLES

Breakfast, burgers, veggies, stir-fry—you name it! Whatever the occasion the ALL-NEW Griddles are perfect for upgrading your grilling options! Built in the USA with #304 stainless steel, the Summerset griddle plate gives you 212 sq. in. of grilling space and the AMG griddle plate gives you an incredible 312 sq. in. of grilling space!



14" SUMMERSET GRIDDLE PLATE
SSGP-14



16.75" AMG GRIDDLE PLATE
SSGP-17AMG

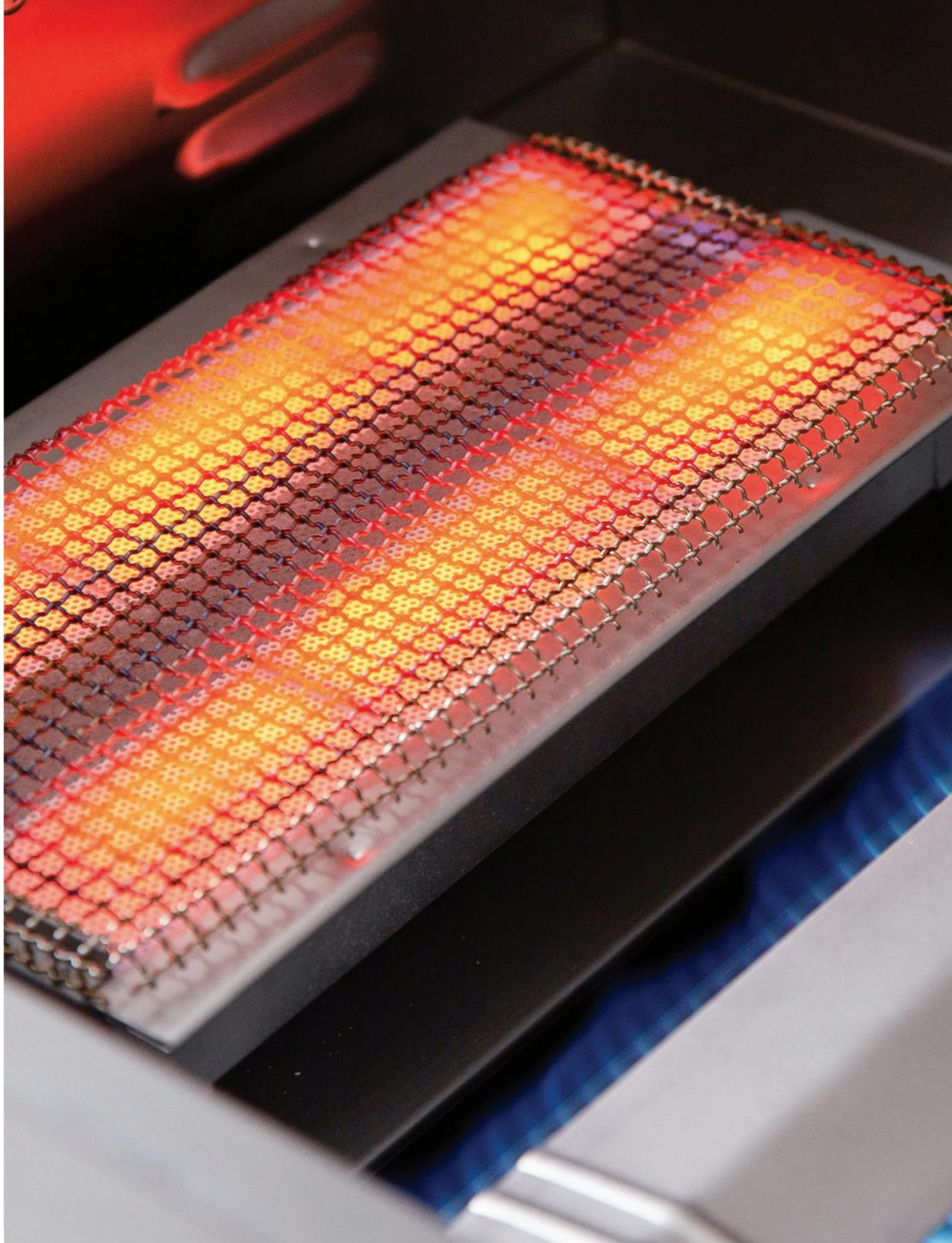

SMOKER TRAYS

Add some pizzazz to an otherwise ordinary meal with the Summerset Smoker Tray. Whether it's mesquite chicken or applewood smoked salmon, the smoker tray is the ultimate meal enhancer that allows for endless flavor options.



SMOKER TRAYS
SSMK-S1Z / SSMK-TRL

CUTTING BOARD & TRASH CHUTE

Add convenience to your outdoor kitchen with the Summerset Grills Cutting Board & Trash Chute. Add the Trash Chute above Summerset's Trash Drawer for easy cleanup. Made from #304 Stainless Steel, Summerset's Trash Chute is durable even in the harshest weather.



14" TRASH CHUTE & CUTTING BOARD WITH LID
SSTC-14

GRILL COVERS

Protect your outdoor kitchen with Summerset Grill Covers. Our heavy-duty PVC covers are 100 percent water-resistant, UV-protected to prevent fading, custom fitted, and feature soft flannel backing (to keep your steel scratch-free). Covers also available for Side Burners.



GRILL COVER
GRILLCOV



CART COVER
CARTCOV

ROTISSERIE KITS AND BAGS

Complete with weather-protected stainless steel motor, fork set, counterbalance and a spit rod for every grill model, the Summerset rotisserie kits have everything you need to start cooking your chicken, turkey, loin or roast like a pro.



SUMMERMET ROTISSERIE KITS
ROTKIT



ROTISSERIE KIT STORAGE BAG
GRILLCOV-ROT32 / GRILLCOV-ROT44
*Rotisserie Kit Sold Separately



SIDE BURNER COVER
GRILLCOV

SIZZLER/ SIZZLER PRO SIDE BURNER BRACKET

Exclusively, the Sizzler models now have even more surface for grilling with the Side Burner Bracket. This unique design allows you to replace the right-hand side shelf with a housing bracket to simply mount a double side burner right next to your grill.



SIDE BURNER BRACKET
CART-SIZ-SB2BK

GAS TIMER / MOUNTING PLATE

Bring utility and safety to your gas grill with the Summerset Gas Timer. Built with matching durable #304 stainless steel to weather the elements, this timer features a simple and sleek design, 1-hour setting, and limited Lifetime Warranty.



GAS TIMER WITH EMERGENCY SHUTOFF / MOUNTING PLATE
SSGT-1HR / SSGT-MP5
*Mounting Plate Sold Separately

AMG CART RIGHT SIDED SHELF

Give your AMG Deluxe cart even more prep surface with a right-hand side cart shelf. Replace the cart side handle with this additional AMG cart shelf and enjoy the freedom of a professional kitchen countertop.



OPTIONAL CART SHELF
AMG-CSR

ALTURI WOOD HANDLE

Harness the rustic elements of the great outdoors with this new handle for the Alturi grill series. Fusing sleek stainless steel with a natural wooden elegance, the Summerset Teak or Ipe wood handle for the Alturi grill is a fine finishing touch to your outdoor kitchen.



ALTURI WOOD HANDLE
(30", 36", 42")
ALT-HTK / ALT-HIP



SUMMERSET'S LIFETIME WARRANTY

Summerset Professional Grills is backed by the strongest warranty in the industry! In addition to precision engineering and outstanding performance, Summerset grill series include a LIFETIME WARRANTY. Now you can use a grill with the peace of mind that you have an industry leading warranty.

SUMMERSET AND AMG SERIES

- Lifetime Warranty on construction and manufacturer defects
- Lifetime Warranty on frame and housing
- Lifetime Warranty on cooking grates, burners and valves
- 1 year Warranty on all other parts, components, and electrical

COMPONENTS

- Lifetime Warranty on construction, workmanship and materials for all stainless steel components, including doors, drawers, ice chests, beverage centers, sinks and grill liners
- 1 year on all other parts and electrical
- Limited (5 year) Warranty on carts
- Limited (1 year) Warranty on grill covers

MADERA PRODUCTS

- Lifetime warranty on construction, workmanship and materials for all stainless steel components

REFRIGERATION

- 2 year warranty on all construction and compressor (SSRFR-21S, SSRFR-21D, SSRFR-24S,)
- 3 year warranty on all construction and compressor (SSRFR-24D, SSRFR-24DR2, SSRFR-24DK1, SSRFR-24DK2, SSRFR-24DWC)
- 1 year warranty on all electrical components

BUILDER GRILL

1 year warranty on workmanship, construction, and manufacturer defects for all commercial and/or hospitality applications. Warranty covers all factory defects. Warranty does not cover regular cleaning, vandalism, misuse, or theft. All warranty claims are subject to manufacturer review. Warranty is valid only provided that regular maintenance is exercised. Due to the nature of commercial applications (multiple users, lack of control of use, etc.) regular maintenance is mandatory

CUTOUTS

For cutouts, dimensions or more information on your Summerset product, visit Summersetgrills.com/cutouts or scan this QR Code with your smartphone's camera app.

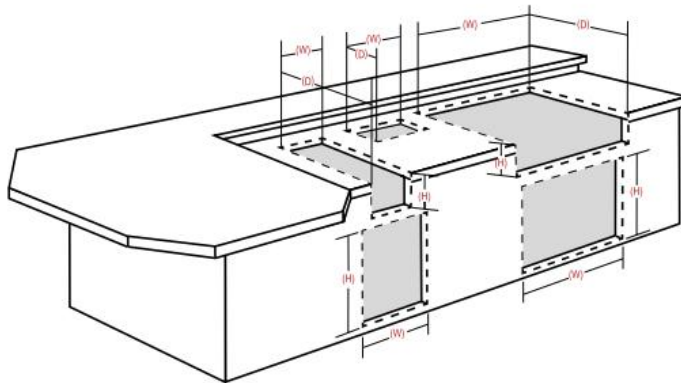

Summerset's Lifetime Warranty is valid for original purchaser at original site of delivery with proof of purchase and photo documentation only. Registration form must be submitted within 30 days of the purchase date to validate the warranty. Warranty is void upon transfer of ownership. Warranty does not apply to products installed in any commercial, rental, or non-residential application. Warranty covers replacement parts only. Manufacturer is not responsible for labor or labor-related costs. Warranty does not cover discoloration, surface rust, corrosion, or oxidation, which may occur due to harsh environments, chemicals, or overheating. Warranty will not apply for damage resulting from improper installations, abuse, extreme environments, grease fires, or misuse. Regular and proper maintenance is required. Coastal, humid, and/or salt environments are subject to manufacturer review. All out-of-box claims must be made within 30 days of purchase and must be made prior to installation. Any product installed damaged will be considered damaged during installation and not covered under warranty. Warranty and registration forms are available at www.SummersetGrills.com. Please be advised - all display models are sold "as is" and the warranty covers the following items only: main burners (Lifetime), grates (Lifetime), burner covers (1 year). All warranties are subject to the review and approval of the manufacturer.



SCAN HERE

SUMMERSET GRILLS

17322 GOTHARD STREET, HUNTINGTON BEACH CA, 92647 • 800.966.8126 • SUMMERSETGRILLS.COM

2019 | VERSION 4