

Table of Contents

1 Description	12
1.1 General Description	12
1.2 Cooktop	13
1.3 Control panel	14
1.4 Other parts	15
1.5 Available accessories	15
2 Use	17
2.1 Instructions	17
2.2 Using the accessories	19
2.3 Using the cooktop	19
2.4 Using the oven	24
2.5 Programming clock	26
2.6 Using the temperature probe	30
2.7 Cooking advice	33
3 Cleaning and maintenance	37
3.1 Instructions	37
3.2 Cleaning the cooktop	38
3.3 Cleaning the oven cavity	40
3.4 Steam clean function	41
3.5 Special maintenance	42

Definitions

This manual contains important safety symbols and instructions. Please pay attention to these symbols and follow all instructions given.



WARNING

This symbol will help alert you to situations that may cause serious bodily harm, death or property damage.



CAUTION

This symbol will help alert you to situations that may cause injury or property damage.

We advise you to read this manual carefully, which contains all the instructions for maintaining the appliance's aesthetic and functional qualities.

For further information on the product: www.smeg.com



Important Safety Instructions

IMPORTANT SAFETY INSTRUCTIONS

Important Note to the Customer



WARNING: Tip Over Hazard

- A child or adult could tip the range over and be killed.
- Verify the anti-tip device has been properly installed and engaged.
- Ensure the anti-tip device is re-engaged when the range is moved.
- Do not operate the range without the anti-tip device in place and engaged.
- Failure to follow these instructions can result in death or serious burns to children and adults.



installing, maintaining, or operating your appliance.

- Check for proper installation and use of the anti-tip bracket. Carefully tip the range forward by pulling it from the back to ensure that the anti-tip bracket engages the range leg and prevents tip-over. The range should not move more than 1" (2.5cm).
- Read all instructions before using this appliance.
- Keep these instructions with your owner's guide for future reference.

Unpacking and installation

- Remove all tape and packaging before using the appliance. Dispose of the carton and plastic bags after unpacking the appliance. Never allow children to play with packaging material. Do not remove the wiring label and other information attached to the appliance. Do not remove model/serial number plate.
- Cold temperatures can damage the electronic control. If this appliance has not been used for a long time, make sure that it has been stored at temperatures above 32°F (0°C) for at least 3 hours before turning on power to the appliance.

Do not attempt to install or operate your appliance until you have read the safety precautions in this manual. Safety items throughout this manual are labeled with a WARNING or CAUTION statement based on the risk type.

Warnings and important instructions appearing in this guide are not meant to cover all possible conditions and situations that may occur. Common sense, caution, and care must be exercised with

Important Safety Instructions



EN

- Never modify or alter the construction of the appliance by removing the leveling legs, panels, wire covers, anti-tip brackets/screws, or any other part of the appliance. Be sure to have an appropriate foam-type fire extinguisher available, clearly visible and easily accessible located near the appliance.
- All materials used in construction of cabinets, enclosures, and supports surrounding the product must have a temperature rating above 200°F (94°C).
- requirements. In Canada, install in accordance with CAN/CGA B149.1 and CAN/CGA B149.2 and CSA Standard C22.1, Canadian Electrical code, Part 1- latest editions and local electrical code requirements. Install only as per the installation instructions provided in the documentation received with this appliance.
- For personal safety, this appliance must be properly grounded. For maximum safety, the power cord must be securely connected to an electrical outlet or junction box that is the correct voltage, is correctly polarized and properly grounded, and protected by a circuit breaker in accordance with local codes.

Grounding instructions



WARNING

- Avoid fire hazard or electrical shock. Failure to follow this warning may cause fire, serious injury, or death.
- Avoid fire hazard or electrical shock. Do not use an adapter plug, an extension cord, or remove the grounding prong from the power plug. Failure to follow this warning may cause fire, serious injury, or death.
- Proper Installation—Be sure your appliance is properly installed and grounded by a qualified technician. In the United States, install in accordance with the National Fuel Gas Code ANSI Z223.1/NPFA No. 54, latest edition and National Electrical Code NFPA No. 70 latest edition, and local electrical code
- It is the personal responsibility of the consumer to have the appropriate outlet or junction box with the correct, properly grounded wall receptacle installed by a qualified electrician. It is the responsibility and obligation of the consumer to contact a qualified installer to ensure that the electrical installation is suitable and in conformance with all local codes and ordinances.
- See the installation instructions provided with this appliance for complete installation and grounding instructions.



Important Safety Instructions

Important instruction for using the appliance

- Persons with a pacemaker or similar medical device should exercise caution using or standing near an induction unit while it is in operation as the electromagnetic field may affect the working of the pacemaker or similar medical device. It would be advisable to consult your doctor or the pacemaker or similar medical device manufacturer about your particular situation.
- Do not touch surface cooking zones, areas near these zones or elements, interior surfaces of the oven, or the warmer drawer (if provided). Surface and oven elements may be hot even though they appear to be cool. Areas near surface elements may become hot enough to cause burns. During and after use, do not touch, or let clothing or other flammable materials come into contact with these areas until they are cool. These areas may include the cooktop, surfaces facing the cooktop, oven vent areas and the oven door and oven window.
- Storage In or On the Appliance - Flammable materials should not be stored in the oven, near surface burners or elements, or in the storage or warmer drawer (if provided). This includes paper, plastic, and cloth items, such as cookbooks, plasticware and towels, as well as flammable liquids. Do not store explosives, such as aerosol cans, on or near the appliance.
- Do not leave children alone - Children should not be left alone or unattended in the area where appliance is in use. They should never be allowed to sit or stand on any part of the appliance, including the storage drawer, lower broiler drawer, warmer drawer, or lower double oven.
- Do not store items of interest to children in the cabinets above the appliance or on the backguards of ranges. Children climbing on or near the appliance to reach items could be seriously injured.
- Do not allow children to climb or play around the appliance. The weight of a child on an open oven door may cause the appliance to tip, resulting in serious burns or other injury. An open drawer when hot may cause burns.
- Stepping, leaning, or sitting on the door or drawers of this appliance can result in serious injuries and also cause damage to the appliance.
- Never cover any slots, holes or passages in the oven bottom or cover and entire rack with materials such as aluminum foil.

Important Safety Instructions



EN

Aluminum foil linings may also trap heat, causing a fire hazard.

- When heating fat or grease, watch it closely. Grease may catch fire if it becomes too hot.
- Do not use water or flour on grease fires.
- Smother fire or flame or use dry chemical or foam-type extinguisher. Cover the fire with a pan lid or use baking soda.
- Only use dry potholders. Moist or damp potholders on hot surfaces may result in burns from steam. Do not let potholders touch hot heating elements or hot cooking areas. Do not use towels or other bulky cloths.
- Do not heat unopened food containers - Build-up of pressure may cause the container to burst and result in injury.
- Wear proper apparel - Loose-fitting or hanging garments should never be worn while using the appliance. Do not let clothing or other flammable materials come into contact with hot surfaces.
- Do not attempt to operate the appliance during a power failure. If the power fails, always turn off the appliance. If the appliance is not turned off, electric surface elements may resume operation when power is restored. Once the power is restored, reset the clock and the oven function.
- Never use your appliance for

warming or heating the room.

Important instruction for using your induction cooktop

- Know which knob or key controls each surface heating area. Place the cookware containing food on the cooking area before turning it on. Turn the cooking area off before removing the cookware.
- Cookware handles should be turned inward and not extend over adjacent surface elements. — To reduce the risk of burns, ignition of flammable materials and spillage due to unintentional contact with the utensil, the handle of the cookware should be positioned so that it is turned inward and does not extend over other cooking areas.
- Use proper pan size — This appliance is equipped with one or more surface units of different sizes. Select cookware with flat bottoms that match the surface unit size. Using the proper cookware on the cooking area will improve efficiency.
- Glazed cooking utensils — Only certain types of cookware are suitable for cooktop service and must be magnetic in order to work properly on the induction zones. Check the manufacturer's recommendations for cooktop use to ensure that the cookware is compatible with induction cooking.



Important Safety Instructions

- Improper cookware may break due to sudden changes in temperature. Check the cookware manufacturer's recommendations for cooktop use.
- Do not place metallic objects such as knives, forks, spoons and lids on the cooktop surface since they can become hot.
- Never leave surface elements unattended. Boil-overs may cause smoking and greasy spills that may ignite. A pan that has boiled dry could be damaged and may damage the cooktop
- When you are flaming foods under a ventilating hood, turn on the fan.

Important instructions for glass and ceramic cooktops



WARNING

- Do Not Clean or Operate a Broken Cooktop. If cooktop should break, cleaning solutions and spillovers may penetrate the broken cooktop and create a risk of electric shock. Contact a qualified technician immediately.

Clean cooktop glass with caution. If a wet sponge or cloth is used to wipe spills on a hot cooking area, be careful to avoid steam burns. Some cleaners can produce harmful fumes if applied to a hot surface. Avoid scratching the cooktop glass with

sharp objects.

Important instructions for using your oven

- Protective liners—Do not use aluminum foil, aftermarket oven liners, or any other materials or devices to line oven bottom, oven racks, or any other part of the appliance. Only use aluminum as recommended for baking, such as lining cookware or as a cover placed on food. Any other use of protective liners or aluminum foil may result in a risk of electric shock, fire or a short circuit.
- Take care when opening oven door, lower oven door, or warmer drawer (some models). Stand to the side of the appliance when opening the door of a hot oven. Let hot air or steam escape before you remove food or place it back in the oven.
- Keep oven vent ducts unobstructed. Touching surfaces in this area when the oven is on may cause severe burns. Do not place plastic or heat-sensitive items on or near the oven vent. These items can melt or ignite.
- Placement of oven racks - Always place oven racks in required position while the oven is cool. If a rack has to be moved while the oven is hot, do not let the potholder come into contact with a hot burner or element in oven. Use potholders and grasp the

Important Safety Instructions



rack with both hands when repositioning it. Remove all cookware and utensils before moving the rack.

- Do not use a broiler pan without its insert.
- Broiler pans and inserts allow dripping fat to drain away from the high heat of the broiler. Do not cover the broiler insert with aluminum foil; exposed fat and grease could ignite.
- Do not cook food on the oven bottom.
- Always cook in proper cookware and always use the oven racks.
- Prevent aluminum foils and the temperature probe from contacting the heating elements.

Important instructions for cleaning your appliance



CAUTION

- Make sure all controls are turned off and that the appliance is cool before manually cleaning any part of the appliance. Cleaning a hot appliance can cause burns.
- Clean the appliance regularly to keep all parts free of grease that could catch fire. Do not allow grease to accumulate. Greasy deposits in the fan could catch fire.

- Always follow the manufacturer's recommended directions when using kitchen cleaners and aerosols. Be aware that excess residue from cleaners and aerosols may ignite causing damage and injury.
- Clean ventilating hoods frequently, grease should not be allowed to accumulate on hood or filter. Follow the manufacturer's instructions for cleaning ventilating hoods.

Important instruction for service and maintenance

- Do not repair or replace any part of the appliance unless specifically recommended in the manuals. All other servicing should be done only by a qualified technician. This reduces the risk of personal injury and damage to the appliance.
- Always contact your dealer, distributor, service agent, or manufacturer about problems or conditions you do not understand.
- Ask your dealer to recommend a qualified technician and an authorized repair service. Know how to disconnect the power to the appliance at the circuit breaker or fuse box in case of an emergency.



Important Safety Instructions

- Remove the oven door from any unused oven if it is to be stored or discarded.
- Do not touch a hot oven light bulb with a damp cloth. Doing so could cause the bulb to break. Handle halogen lights (if provided) with paper towels or soft gloves.
- Disconnect the appliance or shut off the power to the appliance before removing and replacing the bulb.

State of California Proposition 65



WARNING

Cancer or Reproductive Harm -
www.P65Warnings.ca.gov

Important: This appliance has been tested and found to comply with the limits for a class B digital device, pursuant to Part 18 of the FCC rules (United States) and ICES-001 (Canada). These limits are designed to provide reasonable protection against harmful interference in a residential installation. This unit uses and can radiate radio frequency energy that may interfere with radio communications if not installed and used in accordance with the instructions manual. However, there is no guarantee that interference will not occur in a particular installation. If this unit does cause interference to radio or television reception, which can be determined by turning the unit off and on, the user is encouraged to try to correct the interference by one or more of the following measures:

- Reorient or relocate the receiving antennae.
- Increase distance between unit and receiver.
- Connect the unit into an outlet or a circuit different from the one to which the receiver is connected.



How to read the user manual

This user manual uses the following reading conventions:

Instructions



General information on this user manual, on safety and final disposal.

Description



Description of the appliance and its accessories.

Use



Information on the use of the appliance and its accessories, cooking advice.

Cleaning and maintenance



Information for proper cleaning and maintenance of the appliance.



Safety instructions



Information



Advice

1. Use instruction sequence.
 - Single use instructions.

SAVE THESE INSTRUCTIONS



Description

1 Description

1.1 General Description

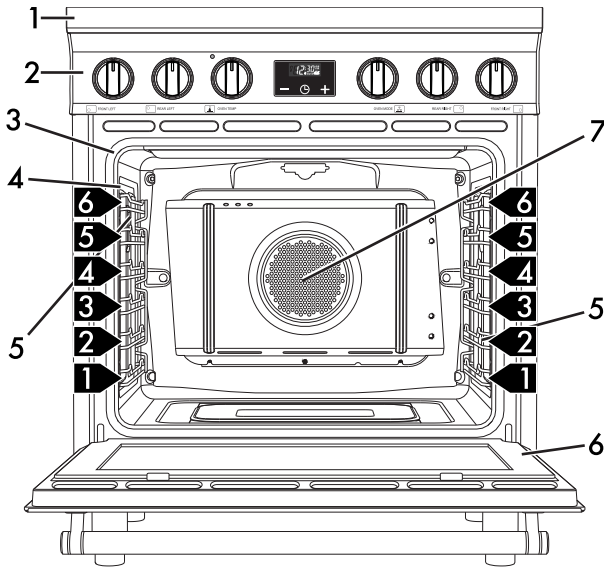

1 Cooktop

2 Control panel

3 Seal

4 Temperature probe socket

5 Oven lights

6 Door

7 Fan

1,2,3... Rack/tray support frame shelf



1.2 Cooktop

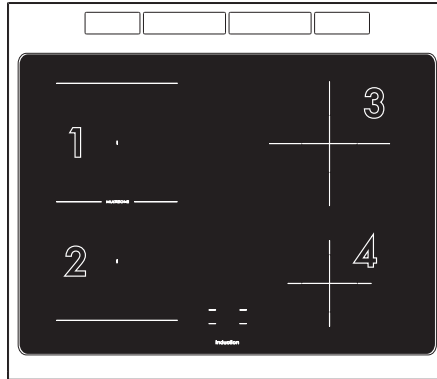

Zone	Dimensions H x L (mm - in)	Max. power draw (W)*	Power draw in Booster function (W)*
1 - 2 Single Zone	205 x 210 - 8" 1/16 x 8" 4/16	1850	3000
1 - 2 Double Zone	410 x 210 - 16" 4/16 x 8" 4/16	3700	-
3	210 x 210 - 8" 4/16 x 8" 4/16	2300	3700
4	145 x 145 - 5" 11/16 x 5" 11/16	1400	2200

* Power levels are approximate and can vary according to the pan used or the settings made.

Advantages of induction cooking



The cooktop is equipped with an induction generator for each cooking zone. Each generator located under the glass ceramic cooking surface creates an electromagnetic field which induces a thermal current in the base of the pan. This means the heat is no longer transmitted from the hob to the pan but created directly inside the pan by the inductive current.

- Energy saving thanks to the direct transmission of energy to the pan (suitable magnetisable cookware is required) compared to traditional electric cooking.
- Improved safety as the energy is only transmitted to the pan placed on the cooktop.
- High level of energy transmitted from the induction cooking zone to the base of the pan.
- Rapid heating speed.
- Reduced danger of burns as the cooking surface is only heated under the base of the pan; foods which overflow do not stick.



Description

1.3 Control panel

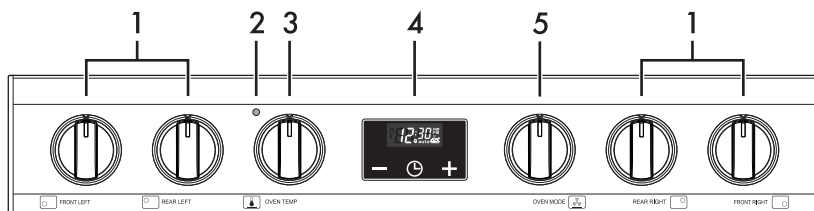

1 Cooktop cooking zones knobs

Used for turning on the cooking zones and adjusting the power levels.

The following markings appear on each cooktop knob:

OFF cooking zone OFF position;

MELT, WARM SIM Melting, Keep Warm and Simmering functions;

1 2..8 9 cooking zones power levels;

P Boost mode.

Only on the front/rear left cooking zones knobs:

A-B Heating Accelerator and Bridge functions;

Only on the front/rear right cooking zone knobs:

A Heating Accelerator function;

🔒 Control Lock function;

2 Hot oven indicator light



CAUTION

High temperature inside the oven.

The indicator light comes on to indicate that the oven is hot.

Each time the indicator light comes on, the appliance emits an acoustic signal.

Depending on the set temperature (from **150 to 500°F**) it will activate after about 10-12 minutes of operation.

It switches off when the oven cavity has cooled down.



NOTE: In Broil mode, the indicator light remains off. It lights up at the end of the function during the cooling phase to indicate that the oven is still hot.

3 Temperature knob

This knob allows you to select the cooking temperature. Turn the knob clockwise to the required value between the minimum and maximum settings.

4 Programmer clock

Used for displaying the current time and setting the timer.

5 Function knob

The oven's various functions are suitable for different cooking modes. After selecting the required function, set the cooking temperature using the temperature knob.



1.4 Other parts

Shelves

The appliance is fitted with shelf supports to position trays and racks at different heights. The insertion heights are indicated from the bottom upwards (see 1.1 General Description).

Interior lighting

The appliance's interior lighting comes on:

- When the door is opened.
- When any function is selected.



NOTE: When the door is open, it is not possible to turn off the interior lighting.

Cooling fan

The fan cools the oven and comes into operation during cooking.

The fan causes a steady outflow of air that exits from the rear of the appliance, which may continue for a brief period of time even after the appliance has been turned off.

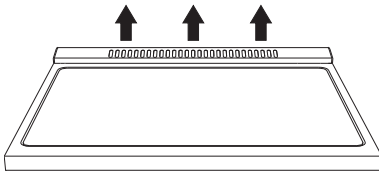

NOTE: Do not obstruct ventilation openings and heat dispersal slots.

1.5 Available accessories

Rack

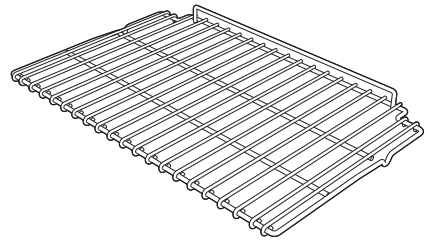

Used to hold containers containing food to be cooked.

Temperature probe



With the temperature probe, you can cook according to the temperature measured at the center of the food.



Description

Protective cover

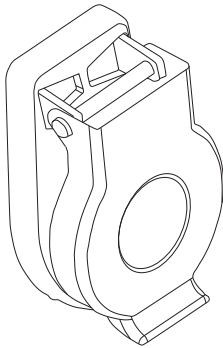

Used to cover and protect the temperature probe socket when the temperature probe is not in use.



NOTE: Some models are not provided with all accessories.

NOTE: The accessories intended to come into contact with food are made of materials that comply with the provisions of current legislation.

NOTE: Supplied and optional can be requested from Authorized Assistance Centers. Use only original accessories supplied by the manufacturer.



2 Use

2.1 Instructions



High temperature inside the oven during use Danger of burns

- Keep the oven door closed during cooking.
- Protect your hands by wearing oven gloves when moving food inside the oven.
- Do not touch the heating elements inside the oven.
- Do not pour water directly onto very hot trays.
- Keep children under the age of 8 away from the appliance when it is in use.
- If you need to move food or at the end of cooking, open the door 5 cm for a few seconds, let the steam come out, then open it fully.



High temperature inside the oven during use Danger of fire or explosion

- Do not spray any spray products near the appliance.
- Do not use or leave flammable materials near the appliance or the storage compartment.
- Do not use plastic cookware or containers when cooking food.
- Do not put sealed tins or containers in the oven.
- Remove all trays and racks which are not required during cooking.



Improper use Risk of damage to surfaces

- Do not cover the bottom of the oven cavity with aluminium or tin foil sheets.
- If you wish to use greaseproof paper, place it so that it will not interfere with the hot air circulation inside the oven.
- Do not place pans or trays directly on the bottom of the oven cavity.
- Do not use the open door to rest pans or trays on the internal glass pane.
- Do not pour water directly onto very hot trays.
- Cooking vessels or griddle plates should be placed inside the perimeter of the hob.
- All pans must have smooth, flat bottoms.
- If any liquid does boil over or spill, remove the excess from the hob.
- Use only pans with perfectly flat and smooth bases on the cooktop.
- Avoid letting heavy objects fall on the cooktop surface.
- In the case of cracks or fractures or if you cannot switch off the appliance, disconnect the power supply immediately and call Customer Service.
- Do not use the cooktop as a work surface.



High temperature Burn hazard

- Protect your hands with thermal gloves during use.
- Do not touch or clean the cooktop surface during operation or when the residual heat warning lights are on.
- Surface units may be hot even though they are dark in color.
- Do not place empty pots and pans on the cooking zones when they are switched on.
- Do not allow children of less than 8 years of age approach the appliance during operation.
- Enables the control lock in the presence of children or pets able to reach the cooktop.
- After use, turn off the cooking zones. They will remain hot for a certain period of time after switching them off. Do not touch the surfaces of the cooktop.
- Do not leave the appliance unattended during cooking operations that could release fats or oils.



High temperature inside the storage compartment Danger of burns

- Do not open the storage compartment when the appliance is on and still hot.
- The items inside the storage compartment could be very hot after using the appliance.

First-time use of the range

1. Remove any protective film from the outside or inside of the appliance, including accessories.
2. Remove any labels (apart from the technical data plate) from the accessories and from the oven cavity.
3. Remove and wash all the appliance accessories (see 3 Cleaning and maintenance).
4. Heat the empty oven to the maximum temperature to burn off any residues left by the manufacturing process.

Sounds

The magnetic field over the induction cooking zone may cause cookware to vibrate, creating a buzzing or humming noise. These sounds are not unusual, especially at high settings.

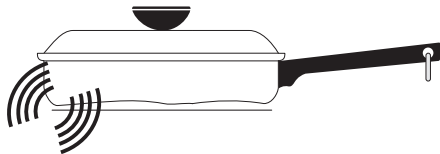

Cookware that is not perfectly flat on the bottom may vibrate slightly against the cooktop.

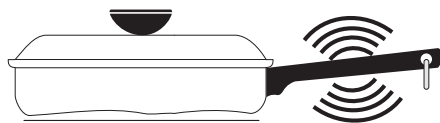

A loose handle may vibrate in its socket.

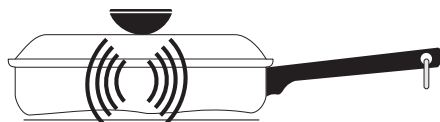

Multi-material cookware may allow small vibrations in its structure.



Sounds are less likely to occur with heavier, higher quality cookware.

An induction cooktop may also produce faint clicking sounds from the electronic switches that maintain the desired cooking temperature. You may also hear a fan that cools the electronics inside the cooktop.

2.2 Using the accessories

Racks and trays

Racks and trays have to be inserted into the side guides until they come to a complete stop. The mechanical safety locks that prevent the rack from being taken out accidentally have to face downwards and towards the oven back.

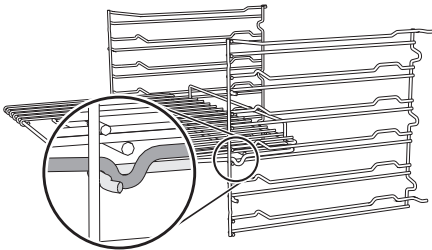

NOTE: Gently insert racks and trays into the oven until they come to a stop.



NOTE: Clean the trays before using them for the first time to remove any residues left by the manufacturing process.

2.3 Using the cooktop

Cookware type

Ideally, cookware should have a flat bottom, straight sides, a tight-fitting lid and medium-to-heavy thickness.

Rough cookware finishes may scratch the cooktop. Aluminum and copper may be used in cookware as a core material or for the base. However, when used as a base they can leave permanent marks on the cooktop or grates. Cookware properties are a factor in how quickly and evenly heat is distributed, which affects cooking results. A non-stick finish has the same characteristics as its base material. For example, a non-stick finish on aluminum cookware will take on the properties of aluminum.

Refer to the following chart as a guide to the physical properties of cookware.

Aluminum

- Heats quickly and evenly.
- Suitable for all types of cooking.
- Medium or heavy thickness is best for most cooking tasks.

Cast iron

- Heats slowly and evenly.
- Good for browning and frying.
- Maintains heat for slow cooking.

Ceramic or glass-ceramic

- Follow the manufacturer's instructions.
- Heats slowly but unevenly.
- Best results with low to medium heat settings.

Copper

- Heats very quickly and evenly.



Use

Earthenware

- Follow the manufacturer's instructions.
- Use low heat settings.

Porcelain enameled steel or cast iron

- See stainless steel or cast iron.



Stainless steel

- Heats quickly but unevenly.
- Stainless steel cookware with an aluminum or copper core or bottom provides even heating.

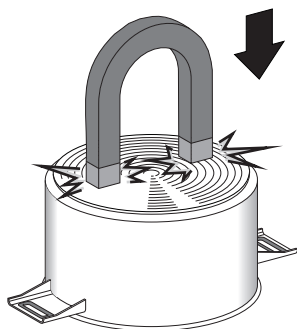
To see whether the pan is suitable, bring a magnet close to the bottom: if it is attracted, the pan is suitable for induction cooking. If you do not have a magnet, you can put a small amount of water in the pan, place it on a cooking zone and start the hot plate. If the  symbol appears on the display, it means the pan is not suitable.



Cookware recognition

When there is no saucepan on a cooking zone or if the saucepan is too small, no energy will be transmitted and the  symbol will appear on the display. If there is a suitable saucepan on the cooking zone, the recognition system detects it and switches on the cooktop to the power level set using the knob. Energy transmission is also interrupted when the saucepan is removed from the cooking zone (the  symbol will be shown on the display). If the cookware recognition function is activated in spite of the saucepan or frying pan on the cooking zone being smaller than the zone itself, only the necessary energy will be transmitted.

Recommended pan size requirements

USE THE CORRECT SIZE COOKWARE -

The cooking zones available on the Induction cooktop require a RECOMMENDED pan size to be used at each location. We recommend using cookware with a diameter that allows efficient cooking. Below is a summary table showing the recommended diameter of the cookware for each cooking zone.

Zone	Cooking zone mode	Recommended diameter
1-2	Single zone	205mm - 8" 1/16
1-2	Single zone w/ Bridge	205mm - 8" 1/16
1-2	Double zone w/ Bridge	400mm - 15" 3/4 *
3	Single zone	210mm - 8" 4/16
4	Single zone	145mm - 5" 11/16

* this measurement refers to the length of an elongated pan. For its width keep a maximum of 210 mm - 8" 4/16.



Use only cookware with a perfectly flat bottom which is suitable for induction hot plates. Using cookware with an irregular bottom could jeopardise the efficiency of the heating system and prevent cookware from being detected on the hot plate.



Limiting the cooking duration

The hob has an automatic device which limits the duration of use. If the cooking zone settings are not changed, the maximum duration of operation for each zone depends on the power level selected. When the device for limiting the duration of use is activated, the cooking zone turns off, a short alert sounds and, if the zone is hot, the **H** symbol appears on the display.

Set power level	Maximum cooking duration in hours
1	8
2	6
3 - 4	5
5	4
6 - 7 - 8 - 9	1 ½
P (Boost mode)	10 minutes

Protection from overheating

If the cooktop is used on full power for a long period, the electronics will have trouble cooling down if the room temperature is high. To avoid excessively high temperatures forming in the electronics, the power to the cooking zone is reduced automatically.

Advice on energy-saving

- The diameter of the base of the pan must correspond to the diameter of the cooking zone.



- When buying a pan, check whether the diameter indicated is that of the base or the top of the pan, as the top is almost always larger than the base.
- When preparing dishes with long cooking times, you can save time and energy by using a pressure cooker, which also helps to retain vitamins contained in the food.
- Make sure that the pressure cooker contains enough liquid as, if there is not enough and it overheats, this may cause damage to both the pressure cooker and the cooking zone.
- If possible, always cover pans with a suitable lid.
- Choose a pan suitable for the quantity of food to be cooked. A large, half-empty saucepan leads to a waste of energy.



NOTE: Under certain circumstances, if the cooktop and the oven are being used at the same time, the maximum power limit that can be used by the electrical system might be exceeded.



Use



Switching the cooking zones on

To switch on a cooking zone simply push in then turn left one of the cooktop cooking zone knobs until its power level digit appears on the cooktop display.

To switch a cooking zone off turn the relative knob to the **OFF (0)** position.

Power levels

The power in the cooking zone can be adjusted to various levels. The table shows the levels suitable for various types of cooking.

Power level	Suitable for:
0	OFF setting
 MELT	Melting butter, chocolate or similar.
 WARM	Warming dishes and keeping small amounts of water boiling, whisking egg yolk or butter sauces.
 SIM	Heating solid or liquid foods, keeping water boiling, thawing frozen foods, making 2- or 3-egg omelets, fruit and vegetable dishes, various preparations.
1 - 2	Cooking small amounts of food (minimum power)
3 - 4	Cooking
5 - 6	Cooking large quantities of food, roasting larger portions
7 - 8	Roasting, slow frying with flour
9	Roasting
P *	Roasting / browning, cooking (maximum power)

* see boost mode

Residual heat



Improper use Danger of burns

- Supervise children carefully as they cannot easily see the residual heat indicator. The cooking zones remain hot for a certain period of time even after they have been turned off. Make sure that children never touch the hob.

If the cooking zone is still hot after being switched off, the **H** symbol will be displayed on the display. The symbol clears once the temperature drops below 60°C.

Boost mode



NOTE: This function allows you to use the maximum possible power for a cooking zone

After activating the required cooking zone:

- Push in a cooking zone knob and turn it all the way to level **9**.
- Turn the knob again to the **P** position.
- the **P** symbol appears on the display.

To deactivate Boost mode, simply bring the knob to the **OFF** position or select another power level.



NOTE: After 10 minutes of operation in Boost mode, the cooktop automatically brings the power to level **9**.



Heating accelerator function

This function allows you to bring the cooking zone to the selected power level more quickly than when selecting the power level.

To activate the Heating accelerator function:

1. Press and hold a cooking zone knob.
2. Keep the knob pressed and turn it counterclockwise to position **A** or **A-B** until the **A** symbol appears on the corresponding cooking zone display (a beep will be emitted).
3. Keep the knob pressed and select the required power level within 3 seconds. The corresponding cooking zone display will show **A** and the selected power level number alternating.

i **NOTE:** Once the selected power level is reached, the Heating accelerator function will be deactivated (the **A** symbol will disappear) and the power level will remain the selected one.

You can increase the power level at any time. The "acceleration" time frame will be modified automatically.

To deactivate the Heating acceleration function, simply bring the knob to the **OFF** position or select a lower power level.

Bridge function



- This function is only available for the zones n. 1 and n. 2. All the other zone combinations are not allowed.
- With the bridge function activated, is it not possible to activate Boost mode.

The bridge function allows you to control two cooking zones simultaneously. This function is useful when cooking with oblong cookware such as roasting pans or fish kettles, or when cooking with two pans at the same time.

To activate the Bridge function:

1. Press and hold turn the front and rear left knobs counterclockwise to the **A-B** positions (a short beep will be emitted):

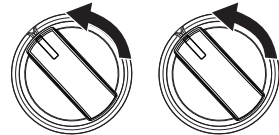

2. Press and turn the rear left cooking zone knob until you reach power level **9** (a long beep will be emitted):

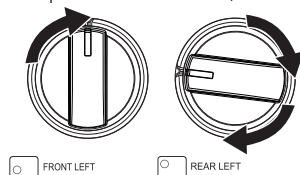



Use

Now both cooking zone displays shows level **0** and flashing red dots appear on all displays. The Bridge function is now activated. You can control both the linked zones using the front left cooking zone knob.

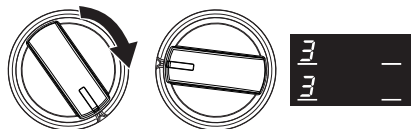



FRONT LEFT

REAR LEFT

To deactivate the Bridge function, bring both knobs to the **OFF** position.

Control lock function

The control lock is a device that protects the appliance from accidental or inappropriate use. Only the cooking zone knobs will be locked. To activate the Control lock function press and hold turn the central cooking zone knob counterclockwise to the  position until all the cooking zone displays

show the  symbols (two short beeps will be emitted in the meantime).

To deactivate the Control lock function, follow the previous instructions until the  symbols disappears.



- After about 10 seconds without interacting with the cooktop knobs, the cooking zone displays will be turned off. To check if the Control lock is active or not, simply try to turn on any cooking zone.
- When you activate Control lock function, if you turn and hold the central cooking zone knob for more than 30 seconds, the flashing symbol  will appear as an error message. Release the knob to remove it.

2.4 Using the oven



WARNING

Fire Hazard

- Keep the oven door closed when the appliance is in use.



NOTE: If there is no power, the cooling fan will not work. Do not try to switch on the oven manually.

To switch on the oven:

1. Select the cooking function using the function knob.
2. Select the temperature using the temperature knob.



- If you wish, you can set the a timed cooking with the programmer clock. If you avoid using the programmer clock and thus setting a manual cooking you have to stop the oven manually by turning both the temperature and the function knobs to the **OFF** position.

Functions list

BAKE

As the heat comes from above and below at the same time, this system is particularly suitable for certain types of food. Traditional cooking, also known as static cooking, is suitable for cooking just one dish at a time. Perfect for all types of roasts, bread and cakes, and in any case, particularly suitable for fatty meats such as goose and duck.

CONV BOTTOM

The combination of the fan with just the bottom heating element allows cooking to be completed more rapidly. This system is recommended for sterilizing or for finishing off the cooking of foods which are already well-cooked on the surface, but not inside, which therefore need a little more heat. Perfect for any type of food.

BROIL

Using the heat released from the central part of the broil element, this function allows you to grill small portions of meat and fish for making kebabs, toasted sandwiches and any types of grilled vegetable side dishes

BROIL MAX

The heat coming from the whole broil element gives perfect grilling results above all for thin and medium thickness meat and in combination with the rotisserie (where fitted) gives the food an even browning at the end of cooking. This function is perfect for sausages, ribs and ham. This function enables large quantities of food, particularly meat, to be grilled evenly.

CONV BROIL

The airflow produced by the fan softens the strong heatwave generated by the broil element, grilling perfectly even very thick foods. Perfect for large cuts of meat (e.g. shin of pork).

CONV BAKE

The operation of the fan, combined with traditional cooking, ensures consistent cooking even with complex recipes. Perfect for biscuits and cakes, even when simultaneously cooked on several levels. (For multiple-level cooking, we recommend using the 2nd and 4th shelves)

TRUE CONV

The combination of the fan and the circular heating element (incorporated in the rear of the oven) allows you to cook different foods on several levels, as long as they need the same temperatures and same type of cooking. Hot air circulation ensures instant and even distribution of heat. It will be possible, for instance, to cook fish, vegetables and biscuits simultaneously (on different levels) without odours and flavours mingling.



Use

STEAM CLEAN

This function makes cleaning easier using the steam produced by a little quantity of water poured onto the appropriate groove placed on the bottom (see "Steam clean function").

DEFROST (Rapid)

Rapid defrost is assisted by the activation of a fan to ensure uniform distribution of room temperature air inside the oven. This function can be used for any type of food.

PIZZA

The operation of the fan, combined with the broil and the bottom heating element, ensures uniform cooking even with complex recipes. Perfect not just for pizzas, but also for biscuits and cakes



2.5 Programming clock



 Value decrease key

 Clock key

 Value increase key

 Ensure that the programmer clock shows the cooking duration symbol  otherwise it will not be possible to turn on the oven.



Press the key  to reset the programmer clock.







Setting the time

i If the time is not set, the oven will not switch on.

On the first use, or after a power failure, the digits  will be flashing on the appliance's display.

1. Keep the clock key  for two seconds. The dot between the hours and the minutes flashes.
2. The time can be set via the value increase key  and value decrease key . Keep the key pressed in to increase or decrease rapidly.
3. Wait 7 seconds. The dot between the hours and the minutes stops flashing.







The symbol  on the display indicates that the appliance is ready to start cooking.

 To change the time, hold down the value increase key  and value decrease key  at the same time for two seconds, then set the time.

Minute minder timer

i The minute minder timer does not stop the cooking operation but rather informs the user when the set time has run out.

The minute minder timer can be activated at any time.









1. Keep the clock key  pressed for a few seconds. The display shows the figures  and the symbol  flashing between the hours and minutes.
2. Use the value increase  and value decrease  keys to set the number of minutes required.
3. Wait approx. 5 seconds without pressing any key to finish setting the minute minder. The current time and the symbol  appear on the display.
4. A buzzer will sound when the set time is reached.
5. Press the value decrease key  to turn the buzzer off.

i The minute minder timer can be set from 1 minute to a maximum of 23 hours and 59 minutes.



Timed cooking

i Timed cooking is the function which allows a cooking operation to be started and then ended after a specific length of time set by the user.

1. Keep the clock key  pressed for a few seconds. The display shows the figures  and the symbol  flashing between the hours and minutes.
2. Press the clock key  again. On the display the digit  appear alternating with the digit  and the symbol  flashing under the minutes.
3. Use the value increase  and value decrease  keys to set the required minutes of cooking.
4. Select a function and a cooking temperature.



5. Wait approx. 5 seconds without pressing any key in order for the function to activate. The current time and the symbol **auto** will appear on the display.

At the end of cooking the heating elements will be deactivated. On the display, the symbol  turns off, the symbol

auto flashes and the buzzer sounds.

6. To turn the buzzer off, simply press one of the programmer clock keys.
7. Press the clock key  to reset the programmer clock.







i It is not possible to set a cooking time of more than 10 hours.

 To cancel the set programming press and hold down the value increase  and the value decrease  keys at the same time and then turn the oven off manually.



Programmed cooking

i Programmed cooking is the function which allows a cooking operation to be started at a set time and then ended after a specific length of time set by the user.

1. Set the cooking time as described in the previous point "Timed cooking".
2. Press the clock key  again. On the display the digit **End**  appear alternating with the current time digit  and the symbol **auto** flashing under the minutes.
3. Use the value increase  and value decrease  to set the cooking end time.
4. Select a function and a cooking temperature.
5. Wait approx. 5 seconds without pressing any key in order for the function to activate. The current time and the symbol **auto** will appear on the display. The symbol  disappear on the display.



At the end of cooking the heating elements will be deactivated. On the display, the symbol  turns off, the symbol **auto** flashes and the buzzer sounds.

6. To turn the buzzer off, simply press one of the programmer clock keys.

7. Press the clock key  to reset the programmer clock.





12h or 24h format

The default mode is 12h format.

1. Keep the value increase key  for a few seconds. The symbols **AM** or **PM** disappear on the display and 24h format is set.
2. Keep the value increase key  for a few seconds to return in 12h format.

Selecting the buzzer

The buzzer can have 3 tones.

1. Hold down the value increase  and value decrease  keys at the same time.
2. Press the clock key . On the display the digit **t0n2** appear.
3. Press the value decrease key  to select a different buzzer tone

(**t0n1** or **t0n3**).



2.6 Using the temperature probe



High temperature of the temperature probe Danger of burns

- Do not touch the rod or the tip of the probe after having used it.
- Wear oven gloves when handling the temperature probe.



Improper use Risk of damage to surfaces

- Take care not to scratch or damage enamelled or chrome-plated surfaces with the tip or the plug of the temperature probe.



Improper use Risk of damage to the appliance

- Do not insert the probe into openings and slots on the appliance.
- When the probe is not in use, make sure that the protective cover is properly closed.



Improper use Risk of injury

- Do not leave the temperature probe unattended.
- Do not allow children to play with the probe.
- Take care not to injure yourself on the sharp parts of the probe.



Improper use Risk of damage to temperature probe

- Do not pull the cable to remove the probe from the socket or from the food.
- Make sure that the probe or its cable do not get caught in the door.
- No part of the probe should be allowed to come into contact with the walls of the oven cavity, the heating elements, the racks or the trays when they are still hot.
- When not in use, the probe should not be kept inside the appliance.
- Make sure the plug of the probe is fully inserted into the socket.
- Do not use the probe to place food into or to remove it from the oven cavity.

With the temperature probe, roasts, pork loin and various cuts and sizes of meat can be cooked to perfection.

The probe, in fact, allows foods to be cooked to perfection because it accurately monitors the core temperature of the food.

The core temperature of the food is measured by a sensor located in the tip of the probe.



Positioning the probe

1. Place the food on a tray.
2. Insert the tip of the probe into the food before placing it in the oven.
3. For best results, make sure that the temperature probe is placed transversely in the thickest part of the food and for least 3/4 of its length. Make sure that it does not touch the tray underneath and that it does not protrude from the food.

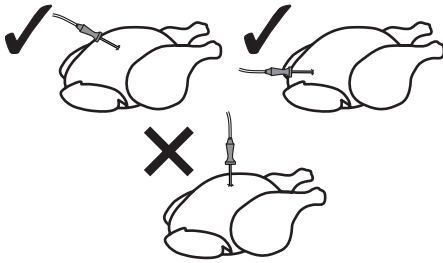

i In order for the probe to measure the core temperature of the food precisely, its tip must not be in contact with bones or fat.

i The minimum recommended oven temperature when cooking using the probe is 250°F, unless slow cooking is used (see Chap. 2.7).

Cooking using the temperature probe

With preheating:

1. Set manual cooking (see “Using the oven”).
2. After preheating, open the door and insert the tray onto which the food has been placed into the appropriate guides.
3. Insert the plug of the probe into the socket at the side, using the probe to open the cover.



High temperature inside the oven during use
Danger of burns

- Wear oven gloves when handling the temperature probe.

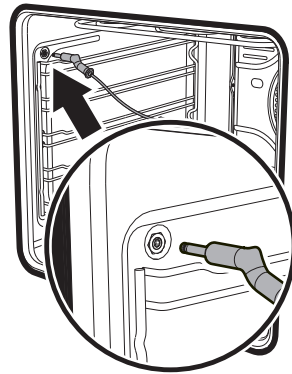



Use

- Close the door.
- Press the button for a few seconds; Press the button again. The default target temperature (176°F) is indicated on the display and the **A** symbol flashes.
- Use the and buttons to regulate the target temperature to a value between the minimum and a maximum.



- **Minimum target temperature:** corresponds to the instantaneous temperature measured by the probe plus 2°C (35°F).
- **Maximum target temperature:** 99°C (210°F)

- Wait for a few seconds and then press the button to display the instantaneous temperature measured by the probe.

Cooking will now continue until the instantaneous temperature measured by the probe is the same as the target temperature set by the user.

Without preheating:

- Open the door.
- Put the tray, on which the food has been placed with the probe in position, into the oven.
- Insert the plug of the probe into the socket at the side, using the probe to open the cover.
- Set the cooking using the probe as indicated in steps 5, 6 and 7 in the previous section.
- Set manual cooking by selecting the temperature and cooking function (see "Using the oven").

When cooking with the temperature probe is in progress



When the temperature probe is used, it is not possible to set programmed cooking or timed cooking.



When cooking with the temperature probe is in progress, the and buttons are disabled.

- Press and hold the button to activate the minute minder timer; press again to display the target temperature and use the and buttons to adjust it while cooking is in progress.
- Press again or wait 5 seconds to return to cooking mode.



At the end of cooking

When the set target temperature for the temperature probe is reached, the heating elements are switched off and the appliance emits a series of beeps.

1. Press a button on the programmer clock to stop the buzzer.
2. Open the door.
3. Remove the probe from the food and unplug it from the socket.
4. Remove the food from the oven.
5. Make sure that the protective cover is properly closed.

2.7 Cooking advice

General advice

- Use pans/trays with a maximum width of 13-14" max.
- It is not possible to shorten cooking times by increasing the temperature (the food could be overcooked on the outside and undercooked on the inside).
- It is recommended to preheat the oven before baking.
- Using several ovens at the same time might affect the final cooking results.

Advice for cooking meat

- Cooking times vary according to the thickness and quality of the food and to consumer taste.
- Turn the food to brown both sides.
- Use a meat thermometer when roasting meat, or simply press on the roast with a spoon. If it is hard, it is ready; if not, it needs another few minutes cooking.

Advice for cooking with the Broiler

- Meat can be grilled even when it is put into a cold oven or into a preheated oven if you wish to change the effect of the cooking.
- When using the Broil function, preheat the oven for 15 minutes before cooking. Cooking times may vary depending on the thickness of the food.
- We recommend placing the food at the center of the rack.
- Foods should be seasoned before cooking. Foods should also be coated with oil or melted butter before cooking.
- Use the oven tray on the first bottom shelf to collect fluids produced by grilling.

Advice for cooking desserts and biscuits

- Temperature and cooking time depend on the quality and consistency of the dough.
- To check whether the dessert is cooked right through, at the end of the cooking time, put a toothpick into the highest point of the dessert. If the batter does not stick to the toothpick, the dessert is done.
- If the dessert collapses when it comes out of the oven, on the next occasion reduce the set temperature by about 50°F, selecting a longer cooking time if necessary.
- While cooking desserts or vegetables, excessive condensation may form on the glass. In order to avoid this, open the door very carefully a couple of times while cooking.



Tips for cooking on two shelves:

- Use a fan-assisted function to achieve uniform cooking at several levels. Use shelves 2 and 4.
- It is recommended to use 2 racks (can be requested from Authorized Assistance Centers).
- To facilitate the flow of air, place the molds/pans in the center of the racks and make sure that their width/diameter does not exceed 11".
- Position the racks keeping an empty level between them.
- Depending on the food and the increased load in the oven, cooking on two levels may take a few minutes longer than on a single shelf.
- The functions indicated for cooking on two shelves are the **CONV** functions.

Advice for defrosting and proving

- Place frozen foods without their packaging in a lidless container on the first shelf of the oven.
- Avoid overlapping the food.
- To defrost meat, use a rack placed on the second level and a tray on the first level. In this way, the liquid from the defrosting food drains away from the food.
- The tenderest parts of the food can be protected with aluminum foil.
- For successful rising, a container of water should be placed at the bottom of the oven.

To save energy

- Unless otherwise indicated on the packaging, defrost frozen food before placing it in the oven.
- In case of multiple cooking, it is advisable to cook the products one after the other to make the most of the already hot oven.
- Use preferably dark metal molds: they help to absorb the heat better.
- Remove all trays and racks which are not required during cooking.
- Stop cooking a few minutes before the time normally used. Cooking will continue for the remaining minutes with the heat that has accumulated inside the oven.
- Reduce any opening of the door to a minimum to avoid heat dispersal.
- Keep the inside of the appliance clean at all times.

Slow cooking with the probe

- This cooking mode is recommended for tender and lean meat whose core temperature should not exceed 65°C (149°F). Set the temperature of the oven to between 90° (194°F) and 100°C (212°F). This increases the cooking time, but maintains the quality of the food and prevents an excessive reduction in its volume.
- For a better result, before slow cooking, brown the meat in a pan over high heat for 1 or 2 minutes on each side.



Cooking information table

Preh = preheating

Runner = position from the bottom

Food	Weight (Kg)	Runner	Function	Preh	Temperature (°F)	Time (minutes)
MEAT						
Roast chicken	1.2	2 - 3	CONV BAKE	Yes	450	65 - 70
Roast loin*	1.5	2 - 3	CONV BAKE	Yes	430	65 - 75

* in a pan on a rack.

DESSERTS						
White cake ¹	1.0	3	BAKE	Yes	350	28 - 30
Biscuits ²	n.9 55 g each.	2	BAKE CONV BAKE	Yes	450	10 - 13
Sugar cookies ²	n.9 15 g each.	2	CONV BAKE	Yes	350	7 - 8
Apple pie ³	1.7 1.1 apple 0.6 dough	3	BAKE	Yes	350 - 375	55 - 65
Cupcakes ⁴	n.12 50 g each.	3	BAKE	Yes	350 - 370	25 - 30

¹ in cake mold Ø 26 cm.

³ in cake mold Ø 23/25 cm.

² flat tray 33 cm wide on rack.

⁴ in muffin mold on oven rack.

GRILLS							1 st side	2 nd side
Hamburger*	n.4 140 g each. thickness 1 cm	5	BROIL	15'	-	9	6	
Sausages* cut and open in half	n.6 180 g each.	4	BROIL	15'	-	15	9	

* food on rack with container underneath.

VEGETABLES						
Roast potatoes*	0.7	2 - 3	CONV BAKE	Yes	450	45 - 50

* in aluminum tray 28 x 30.

FRESH DOUGHS						
Pizza*	0.5 - 0.6	2	CONV BAKE	Yes	MAX	11 - 14

* in baking tray with low edge Ø 28/30 cm.

FRESH FISH						
Bream*	0.6	2 - 3	CONV BAKE	Yes	400	25 - 30

* in a pan on a rack.

The times indicated in the table do not include preheating times and are provided as a guide only.



Use

Temperature probe-cooking information table

Type and cut of meat	Target temperature (°C)	Target temperature (°F)
Beef		
Roast beef: rare	50 - 53	122 - 127
Roast beef: medium	55 - 58	131 - 136
Roast beef: well done	65 - 70	149 - 158
Rib of beef: rare*	50	122
Rib of beef: medium*	58	136
Rib of beef: well done*	70	158
Pork		
Roast loin	80 - 85	176 - 185
Shoulder	80 - 85	176 - 185
Sausages**	75 - 80	167 - 176
Veal		
Veal roast	75 - 80	167 - 176
Poultry		
Whole chicken	80 - 85	176 - 185
Whole turkey	80 - 85	176 - 185
Roast turkey (whole or breast)	80 - 85	176 - 185
Lamb		
Leg of lamb with bone (rare)	65	149
Leg of lamb with bone (well done)	75 - 80	167 - 176
Slow cooking		
Beef / roast beef: rare***	50 - 54	122 - 129
Beef / roast beef: medium***	55 - 60	131 - 140
* Cooking times vary according to the thickness of the fillet.		
** For sausages, it is recommended to select a suitable function to ensure they are well grilled externally.		
*** It is recommended to brown the meat on each side in a pan for a few minutes before putting it in the oven.		



3 Cleaning and maintenance

3.1 Instructions



WARNING

Electrical Shock Hazard

- Before servicing, disconnect the appliance from the power supply.



WARNING

Risk of damage to surfaces

Improper use

- Do not use steam jets to clean the appliance.
- Do not use cleaning products containing chlorine, ammonia or bleach on steel parts or parts with metallic finishes on the surface (e.g. anodizing, nickel- or chromium-plating).
- Do not use abrasive or corrosive detergents on glass parts (e.g. powder products, stain removers and metallic sponges).
- Do not use rough or abrasive materials or sharp metal scrapers.
- Keep cooktop area clear and free from combustible materials, gasoline other flammable vapors and liquids.
- Do not obstruct the flow of combustion and ventilation air.

Recommendations



NOTE: We recommend the use of cleaning products distributed by the manufacturer.

To keep the surfaces in good condition, they should be cleaned regularly after use. Let them cool first.

Regular daily cleaning

Always use only specific products that do not contain abrasives or chlorine-based acids.

Pour the product onto a damp cloth and wipe the surface, rinse thoroughly and dry with a soft cloth or a microfiber cloth.

Food stains or residues

Do not use metallic sponges or sharp scrapers as they will damage the surfaces.

Use ordinary non-abrasive products with the aid of wooden or plastic utensils if necessary. Rinse thoroughly and dry with a soft cloth or a microfiber cloth.

Do not allow residues of sugary foods (such as jam) to set inside the oven. If allowed to set for too long, sugar residue could pit the enamel lining of the oven.



NOTE: After cleaning, dry the appliance thoroughly to prevent any water or detergent from interfering with its operation or creating unsightly marks.



Cleaning and Maintenance

3.2 Cleaning the cooktop

Cleaning the glass ceramic surface

Light coloured marks from pans with aluminium bases can be easily cleaned off with a cloth moistened in vinegar. After cooking, remove any burnt residues; rinse with water and dry thoroughly with a clean cloth.

Dirt which may have fallen on the hob while cleaning lettuce or potatoes can scratch the hob when moving pans.

Consequently, remove any dirt from the cooking surface immediately.

Changes in colour do not affect the operation and stability of the glass. These are not alterations to the material of the hob but just residues which have not been removed and have then carbonised.

Shiny surfaces can form due to the bases of pans, especially aluminium ones, rubbing on the surface, and due to the use of unsuitable detergents. They are difficult to remove using conventional cleaning products. It may be necessary to repeat the cleaning process several times. Use of corrosive detergents or rubbing of pan bases can wear away the decoration on the hob over time and contribute to the formation of stains.

Weekly cleaning

Clean and maintain the hob once a week using an ordinary glass ceramic cleaning product. Always follow the manufacturer's instructions. The silicon in these products creates a protective, water-repellent membrane which also resists dirt. All marks stay on the membrane and can therefore be removed easily. After cleaning, dry the surface with a clean cloth. Make sure that there is no detergent left on the cooking surface as it might undergo an aggressive reaction when heated up and could modify the structure of the cooking surface.

Knobs



NOTE: Do not use aggressive products containing alcohol or products for cleaning steel and glass when cleaning the knobs, as these products could cause permanent damage.

The knobs should be cleaned with a soft cloth dampened with lukewarm water, then dried carefully. They can be removed by pulling them out from their housings.



Removing the oven door

To facilitate cleaning, we recommend that you remove the door and place it on a towel.

To remove the door, proceed as follows:

1. Open the door completely and insert two pins into the holes in the hinges, as shown in the image.

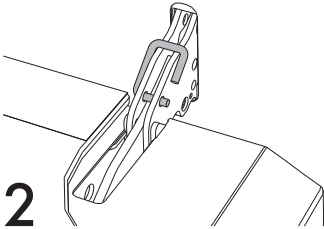
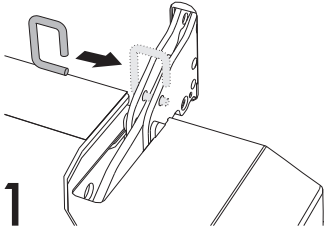

2. Grasp the door on both sides with both hands, lift it forming an angle of around 30° and remove it.

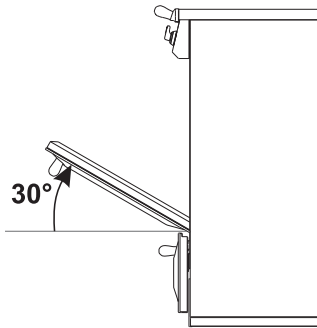

3. To reassemble the door, put the hinges in the relevant slots in the oven, making sure that the grooved sections **A** are resting completely in the slots. Lower the door and once it is in place remove the pins from the holes in the hinges.

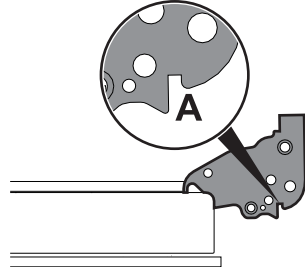

Cleaning the oven door glass

The oven door glass should always be kept thoroughly clean. Use absorbent kitchen roll. In case of stubborn dirt, wash with a damp sponge and an ordinary detergent.

Removing the inner glass

To facilitate cleaning, the inner glass panels of the door can be removed.

1. Remove the inner glass panel by pulling it gently upward at the rear, moving it as indicated by the arrows (1).

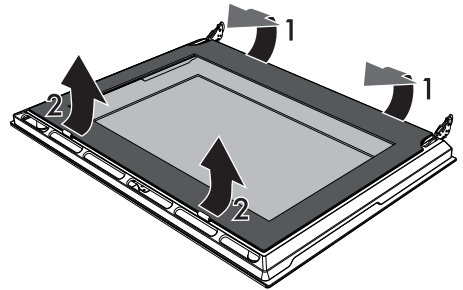



Cleaning and Maintenance

2. Then pull the front part of the glass panel upwards (2). This way, the four pins attached to the glass panel are disengaged from their grooves in the door.
3. Remove the intermediate glass pane by lifting it upwards.

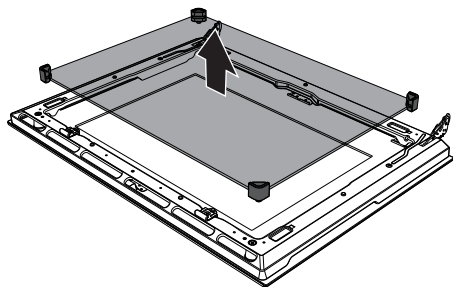

4. Clean the external glass panel and the one you just removed. Use paper towels. If there are tough to clean spots, use a damp sponge and mild detergent.

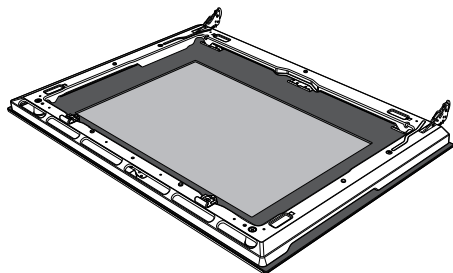

5. Reinsert the glass panels in the reverse order of removal.

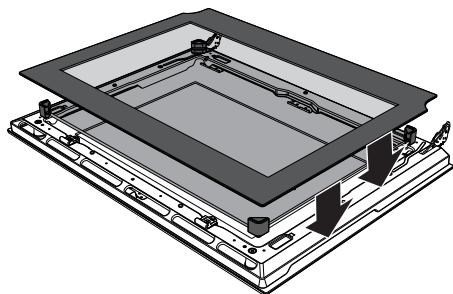

6. Replace the inner glass panel. Make sure you center and insert the four pins into their grooves in the door, using a little pressure.

3.3 Cleaning the oven cavity

In order to keep your oven in the best possible condition, clean it regularly after letting it cool down.

Avoid letting food residue dry inside the oven cavity, as this could damage the enamel.

Take out all removable parts before cleaning.

For easier cleaning, we recommend removing:

- the door;
- the rack/tray supports;
- removable guides, where fitted;
- the seal.



NOTE: If you use specific cleaning products, we recommend running the oven at maximum temperature for 15-20 minutes in order to eliminate any residues.



Removal of the rack/tray supports

Removing the guide frames makes it easier to clean the sides of the oven.

To remove the guide frames:

- Pull the frame towards the inside of the oven to unhook it from its housing **A**, and then slide it out of the grooves at the back **B**.

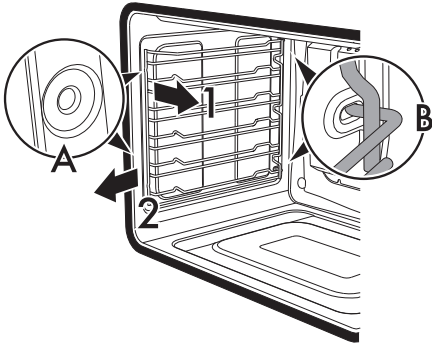

- When you have finished cleaning the oven, repeat the procedures indicated above in reverse to replace the guide frames.

3.4 Steam clean function



CAUTION

Improper use

Risk of damaging the surfaces

- Remove any food residues or large spills from previous cooking operations from the inside of the oven.
- Carry out steam assisted oven cleaning operations only when the oven is cold.

Preliminary operations

Before starting the Steam clean function:

1. Completely remove all accessories from inside the oven. The upper guard can be left inside the oven.

2. Pour approximately 13.5 fl. oz. (400 cc - 1.7 cup) of water onto the bottom of the oven. Make sure it does not overflow out of the cavity.

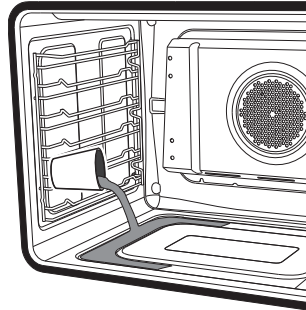

3. Spray a water and washing up liquid solution inside the oven using a spray nozzle. Direct the spray towards the side walls, upwards, downwards and towards the deflector.



We recommend spraying approx. 20 times at the most.

4. Close the door.

Steam clean settings

1. Turn the function knob to the **STEAM CLEAN** position and the temperature knob to 150°F (65°C).
2. Set a cooking time of 45 minutes using the programmer clock.
3. At the end of the cooking time, the timer will switch the oven heating elements off and the buzzer will start to sound.

End of the Steam clean function

1. Open the door and wipe away the less stubborn dirt with a damp cloth.
2. Use a non-scratch sponge with brass filaments to remove hard deposits.
3. In case of grease residues use specific oven cleaning products.



Cleaning and Maintenance

4. Remove the water left inside the oven.

For improved hygiene and to avoid food being affected by any unpleasant odours, we recommend that the oven is dried using a convection function at 300°F for approximately 10 minutes.

3.5 Special maintenance

Seal maintenance tips

The seal should be soft and elastic.

- To clean the seal, use a non-abrasive sponge and wash with lukewarm water.

Replacing the internal light bulb



WARNING

Danger of electrocution

- Unplug the appliance.
- Use protective gloves.



NOTE: The oven is fitted with two 40W light bulbs.

1. Completely remove all accessories from inside the oven.
2. Remove the rack/tray supports.

3. Use a tool (e.g. a spoon) to remove the bulb cover.

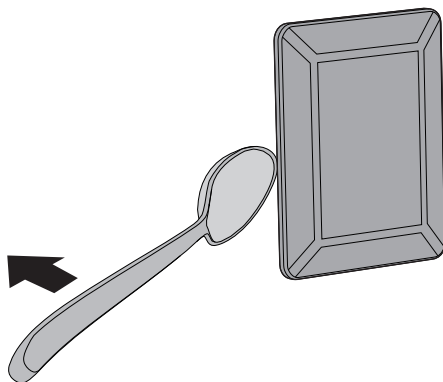

NOTE: Pay attention not to scratch the oven cavity enamel.

4. Loosen and remove the light bulb.

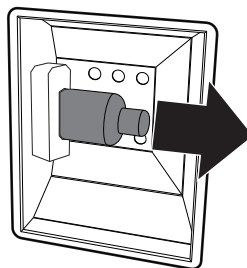

Do not touch the halogen bulb with your fingers; cover it with an insulating cloth.

5. Replace the bulb with a similar one (40 W).



6. Reattach the cover. Leave the inside of the glass molding (**A**) facing the door.

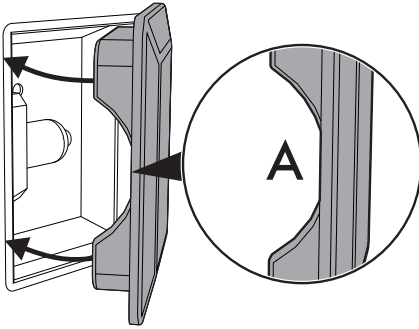

7. Press the cover firmly so that it adheres tightly to the light bulb holder.

PAGE INTENTIONALLY LEFT BLANK