

SFU6300TVX



| | |
|-----------------|-------------------|
| Category | 24" |
| Product family | Oven |
| Power supply | Electrical |
| Cooking method | Thermo-ventilated |
| Cleaning system | VaporClean |
| EAN code | 8017709284831 |



Aesthetic

| | | | |
|------------|-------------------|----------------------|-----------------|
| Aesthetics | Classic | Stainless steel type | Brushed |
| Color | Stainless steel | Silkscreen color | Black |
| Finishing | Fingerprint-proof | Silkscreen type | Symbols |
| Design | Flat | Handle color | Stainless steel |
| Material | Stainless steel | Logo | Embossed |

Controls











| | | | |
|--------------|------------|--------------------|-----|
| Display name | DigiScreen | Display technology | LED |
|--------------|------------|--------------------|-----|

Programs / Functions

No. of cooking functions 8

Traditional cooking functions

| | | |
|--|--|--|
|  Static |  Fan-assisted |  True European convection |
|  Turbo |  ECO Eco |  Large grill |
|  Fan grill (large) |  Bottom | |

Other functions

| |
|--|
|  Defrost by time |
|--|

Cleaning functions

 Vapor Clean

Options



| | | | |
|-----------------------------|--|--------------------------|-----|
| Time-setting options | Delayed start and automatic shut-off when cooking ends | Timer | 1 |
| Minute minder | Yes | Rapid pre-heating | Yes |

Technical Features



| | | | |
|--------------------------------------|---------|--|------------------|
| Minimum Temperature | 122 °F | Large grill - Power | 2700 W |
| Maximum temperature | 482 °F | Circular heating element - Power | 1550 W |
| No. of shelves | 5 | Heating elements stop when door is opened | Yes |
| Fan | Single | Door | Cool-touch door |
| No. of lights | 2 | Removable inner door | Yes |
| Lighting | Halogen | Total no. of door glasses | 3 |
| Replaceable light | Yes | Safety thermostat | Yes |
| Light power | 40 W | Cooling system | Tangential |
| Light on when door is open | Yes | Cooling duct | Double |
| Lower heating element power | 1200 W | Cooling System Speed Reduction | Yes |
| Upper heating element - Power | 1000 W | Cavity material | EverClean enamel |
| Grill element - power | 1700 W | | |

Performance / Energy Label



Volume of the cavity 2.54 cu. ft.

Accessories Included

| | | | |
|----------------------------|---|--------------------------------|---|
| Rack with back stop | 1 | Enameled 1.6"-deep tray | 1 |
| Insert grid | 1 | | |

Electrical Connection

| | | | |
|----------------------|--------|--------------------------|----------|
| Voltage | 230 V | Current | 13 A |
| Nominal power | 3400 W | Frequency | 60 Hz |
| | | Power cord length | 45 1/4 " |

Voltage

120/208 V

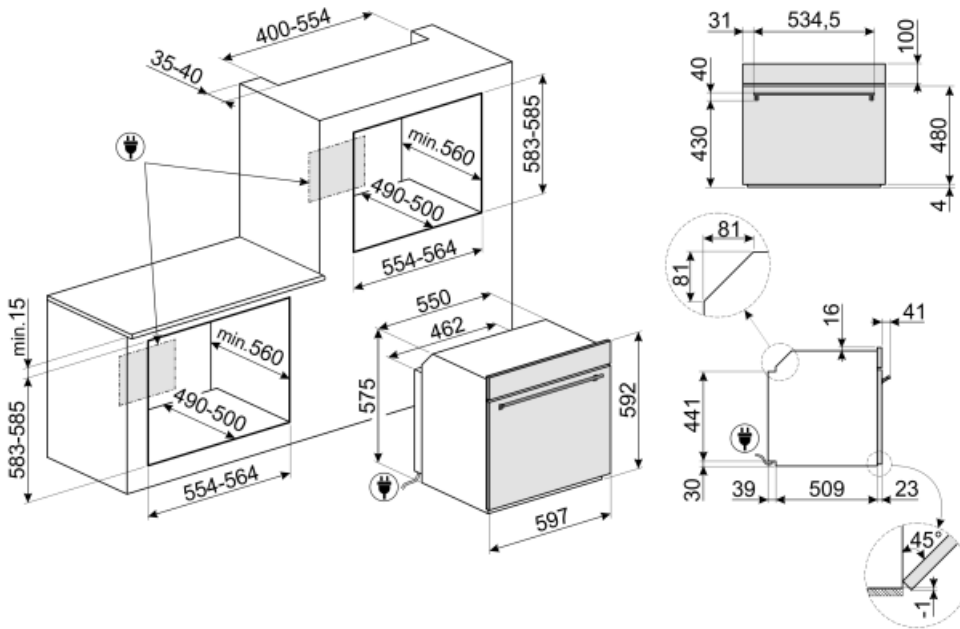

Not included accessories

GTP

****Partial-extension telescopic guides****
Length: 14" Extraction: 11 1/4" Material:
Stainless steel AISI 430 polished



PRTX

Refractory pizza stone with handles.
D=35cm Not suitable for microwave
ovens. Suitable for gas ovens, to be put
on the griddle.



GT1P-2

Partially extractable telescopic guides
(1 level) for ovens with metal frames.
Length: 355.5 mm, extraction: 285 mm.
Material: Stainless steel AISI 430
polished.



GTT

****Total-extension telescopic guides****
Length: 14" Extraction: 16.5" Material:
Stainless steel AISI 430 polished



PR3845X

Antifingerprint stainless steel. Cover
for furniture in column installation of
more ovens



BN620-1

Enamelled tray, 20mm deep



PALPZ

Pizza shovel with fold away handle
width: 315mm length : 325mm























BN640

Enamelled tray, 40mm deep



Symbols glossary (TT)

| | |
|--|---|
|  <p>Air cooling system: to ensure a safe surface temperatures.</p> |  <p>Defrost by time: with this function the time of thawing of foods are determined automatically.</p> |
|  <p>Triple glazed doors: Number of glazed doors.</p> |  <p>Electric</p> |
|  <p>Enamel interior: The enamel interior of all Smeg ovens have a special antacid lining which helps keep the interior clean by reducing the amount of cooking grease adhering to it.</p> |  <p>Fan with upper and lower elements: The elements combined with the fan aim to provide more uniform heat, a similar method to conventional cooking, so pre-heat is required. Most suitable for items requiring slow cooking methods.</p> |
|  <p>Upper and lower element only: a traditional cooking method best suited for single items located in the centre of the oven. the top pf the oven will always be hottest. Ideal for roast, fruit cakes, bread etc.</p> |  <p>Lower heating element only: This function is ideal for foods that require extra base temperature without browning, e.g. pastry dishes, pizza. Also suitable for slow cooking of stews and casseroles.</p> |
|  <p>Circulaire: The combination of the fan and circular element around it gives a hot air cooking method. This provides many benefits including no preheat if cook time is more than 20 minutes, no flavour transfer when cooking different foods at the same time, less energy, and shorter cook times. Good for all types of food.</p> |  <p>ECO: The combination of the grill, fan and lower element is particularly suitable for cooking small quantities of food.</p> |
|  <p>Grill element: Using of grill gives excellent results when cooking meat of medium and small portions, especially when combined with a rotisserie (where possible). Also ideal for cooking sausages and bacon.</p> |  <p>Fan with grill element: The fan reduces the fierce heat from the grill, providing an excellent method of grilling various foods, chops, steaks, sausages etc. giving even browning and heat distribution, without drying out the food. The top two levels recommended for use, and the lower part of the oven can be used to keep items warm at the same time, an excellent facility when cooking a grilled breakfast. Half grill (centre portion only) is ideal for small quantities of food.</p> |
|  <p>Circulaire with upper and lower elements: The use of the fan with both elements allows food to be cooked quickly and effectively, ideal for large joints that require thorough cooking. It offers a similar result to rotisserie, moving the heat around the food, instead of moving the food itself, enabling any size or shape to be cooked.</p> |  <p>The inner door glass: can be removed with a few quick movements for cleaning.</p> |
|  <p>...</p> |  <p>Side lights: Two opposing side lights increase visibility inside the oven.</p> |
|  <p>Rapid preheat: The rapid preheat function can be used to reach the selected temperature in just a few minutes.</p> |  <p>The oven cavity has 5 different cooking levels.</p> |
|  <p>Vapor Clean: a simple cleaning function using steam to loosen deposits in the oven cavity.</p> |  <p>The capacity indicates the amount of usable space in the oven cavity in litres.</p> |