



Dishwashers

SD-9241SS-Stainless Steel

SD-9241W-White

Instruction Manual

<i>Dishwasher Features</i>	1
<i>Safety Information</i>	2
<i>Operating Instructions</i>	
Control Panel	3
Dishwasher Features	3
Wash Cycle Table	4
Detergent	5
Rinse Aid	5
All-in-1 Program	6
Loading the Dishwasher Rack	7
Silverware Basket	8
Turning On the Appliance	8
Filtering System	9
Caring for the Dishwasher	9
Electrical Connection	10
<i>Troubleshooting Tips</i>	
Before calling for service	11,12
Warranty	13

DISHWASHER FEATURES

This electric dishwasher has the common characteristics of other house-hold dishwashers, as well as these unique specialties:



Time delay feature

Allows you to program the operation to begin at a later time, between 1 to 24 hours. Program to run during off-peak hours helps reduce electricity cost.



Error alarm

Fault codes display would inform the user of abnormal status of the machine.



Rinse aid Warning Indicator

When the rinse aid is running low, a refill reminder will be displayed on the panel. This ensures the machine continues to operate at optimum performance.



Stainless steel tub



6 wash programs

Choose from 6 wash cycles, based on load and soiled level: All-in-1, Heavy, Normal, Light, Rinse and Speed.



NOTE:

The manufacturer, following a policy of constant development and up-dating of the product, may make modifications without giving prior notice.

IMPORTANT SAFETY INFORMATION

READ ALL INSTRUCTIONS BEFORE USING

WARNING!

When using your dishwasher, follow the below basic precautions including the following:



GROUNDING INSTRUCTIONS

- This appliance must be grounded. In the event of a malfunction or breakdown, grounding will reduce the risk of electric shock by providing a path of least resistance of electric current. This appliance is equipped with a cord having an equipment-grounding conductor and a grounding plug. The plug must be plugged into an appropriate outlet that is installed and grounded in accordance with all local codes and ordinances.

WARNING!

- Improper connection of the equipment-grounding conductor can result in a risk of electric shock. Check with a qualified electrician or service representative if you are in doubt whether the appliance is properly grounded. Do not modify the plug provided with the appliance ;If it is not fit for the outlet .have a proper outlet installed by a qualified electrician.



WARNING! PROPER USE

- Do not abuse, sit on, or stand on the door or dish rack of the dishwasher.
- Do not touch the heating element during or immediately after use.
- Do not wash plastic items unless they are marked dishwasher safe or the equivalent. For plastic items not so marked, check the manufactures recommendations.
- Use only detergent and rinse additives designed for an automatic dishwasher. Never use soap , laundry detergent, or hand washing detergent in your dishwasher. Keep these products out of children's reach.
- Keep child away from detergent and rinse aid, keep child away from the open door of the dishwasher, there could still be some detergent left inside.
- The door should not be left in the open position since this could present a tripping hazards.
- During installation, the power supply must not be excessively or dangerously bent or flattened.
- Do not tamper with controls.
- The appliance is not intended for use by young children or infirm persons without supervision.
- Dishwasher detergents are strongly alkaline, they can be extremely dangerous if swallowed. Avoid contact with skin and eyes and keep children away from the dishwasher when the door is open.
- Do not operate your dishwasher unless all enclosure panels are properly inplace. Open the door very carefully if the dishwasher is operating, there is a risk of water squirting out.
- Do not place any heavy objects of stand on the door when it is open. The appliance could tip forward.
- When loading items to be washed:
 - 1) Locate sharp items so that they are not likely to damage the door seal;
 - 2) Load sharp knives with the handles up to reduce the risk of cut-type injuries.
- When using your dishwasher, you should prevent plastic item from contacting with heating element.
- If the supply cord is damaged, it must be replaced by the manufacturer or its service agent or a similarly qualified person in order to avoid a hazard.
- Please dispose of packing materials properly.
- Use the dishwasher only for its intended function.
- Remove the door to the washing compartment when removing an old dishwasher from service or discarding it.
- Young children should be supervised to ensure that they do not play with the appliance.
- Check that the detergent receptable is empty after completion of the wash cycle.

READ AND FOLLOW THIS SAFETY INFORMATION CAREFULLY

SAVE THESE INSTRUCTIONS

IMPORTANT!

To get the best performance from your dishwasher, read all operating instructions before using it for the first time.

Control Panel

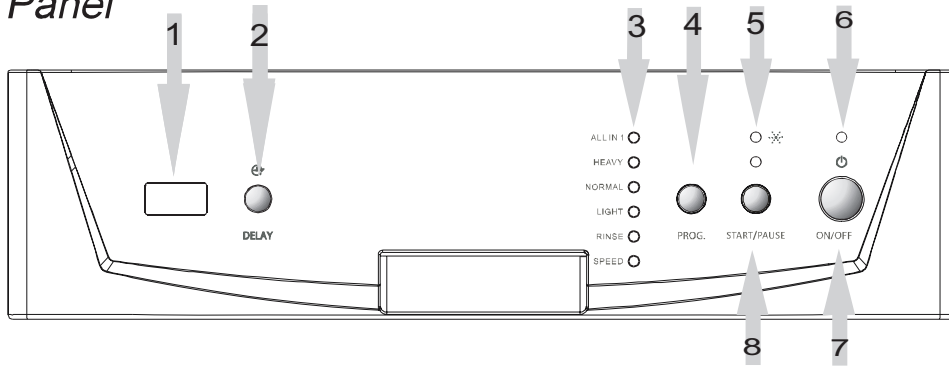

- 1** Display window: Program remaining time, delay time, running indicator, fault codes and etc.
- 2** Delay Button : Press to program delay start.
- 3** Program indicator lights: Indicates the selected wash cycle.
- 4** Wash Program Selector: Press to select one of the six programs.
- 5** Rinse aid low warning light.
- 6** Power indicator light.
- 7** Power switch: To turn on/off the power supply.
- 8** Start /Pause button: To start the selected washing program or pause the washing program when the machine is working.

Dishwasher Features

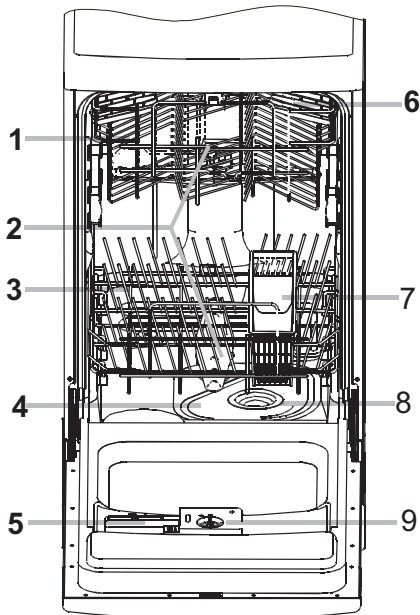



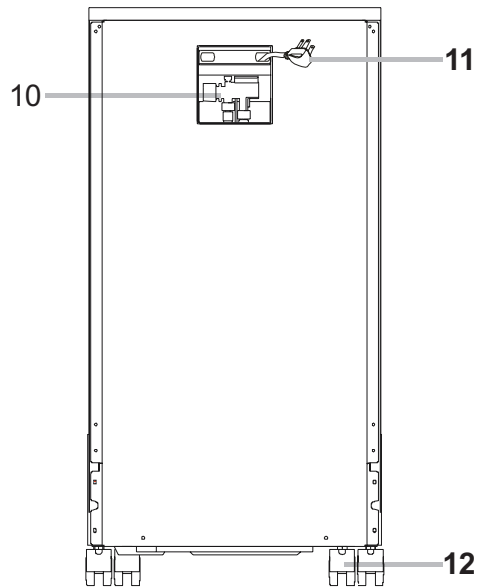

**Front View
(Door Open)**



Back View

- 1 Upper Basket
- 2 Spray Arms
- 3 Lower Basket
- 4 Main Filter
- 5 Detergent Dispenser
- 6 Cup Shelf
- 7 Silverware Basket
- 8 Coarse Filter
- 9 Rinse Aid Dispenser
- 10 Portable Faucet Adapter Assembly
- 11 Power Cord
- 12 Caster

WASH CYCLE TABLE

Program	Cycle Selection Information	Description of Cycle	Detergent pre/main	Running time(min)	Energy (Kwh)	Water (gal)	Rinse Aid
All in 1	For all soiled loads, such as pots, pans, casserole dishes and dishes that have been sitting with dried food on them for a while.	Pre-wash Pre-wash wash (136°F) Rinse (154°F) Drying.	All in1	130	0.6	3.7	★
 Heavy	For the heaviest soiled loads, such as pots, pans, casserole dishes and dishes that have been sitting with dried food on them for a while.	Pre-wash Pre-wash (122°F) Wash (136°F) Rinse Rinse (149°F) Drying	18g	135	0.58	4.6	★
 Normal (AHAM)	For normally soiled loads, such as pots, plates, glasses and lightly soiled pans. standard daily cycle.	Pre-wash Wash (136°F) Rinse Rinse (149°F) Drying	18g	115	0.545	3.65	★
 Light	For lightly soiled loads, such as plates, glasses, bowls and lightly soiled pans.	Pre-wash Wash (122°F) Rinse Rinse (140°F) Drying	18g	100	0.43	3.67	★
 Rinse	For dishes that just need a quick rinse.	Pre-Wash Pre-Wash		25	0.05	1.9	
 Speed	A shorter wash for lightly soiled loads .	Pre-Wash Wash (122°F) Rinse (131°F) Drying	18g.	65	0.32	2.75	

ERROR CODES

When unit experiences malfunction, the appliance will display error codes

Codes	Meanings	Possible Causes
E1	Long inlet time.	Faucets is not opened, or water intake is restricted, or water pressure is too low.
E3	Long heating time, unit not reaching the required temperature	Malfunction of temperature sensor or of heating element.

DETERGENT DISPENSER

TO PREVENT FORMATION OF DEPOSITS, DO NOT ADD TOO MUCH DETERGENT. THIS DISHWASHER HAS SPECIALLY-DESIGNED WATER SOFTENERS.

The dispenser must be refilled before the start of each wash cycle. Refer to instructions under the Wash Cycle Table on page 4. This unit uses less detergent and rinse aid than most conventional dishwashers. In general, only one tablespoon of detergent is needed for a normal wash load. Add more detergent as needed for heavily soiled loads.

Always add detergent just before starting the dishwasher, otherwise it could get damp and not dissolve properly.

Amount of Detergent to Use

The amount of detergent needed can vary due to differences in water hardness. To determine the water hardness in your area, contact your local water utility or area water softening company. The harder the water, the more detergent you may need. Remember, you should adjust the amount of detergent you use by small amounts until you find the correct amount.

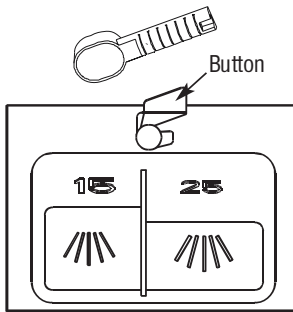

Removing Hard Water Spots

To remove hard water spots, try the following:

- Run dishes through a normal wash program.
- Remove all metal dishware, such as cutlery, pans, etc., from the dishwasher.
- Do not add detergent.
- Pour two cups of vinegar into a bowl and set the bowl face up on the lower rack of the dishwasher.
- Run the dishes through a normal wash program.

If this doesn't work, try the same process with 1/4 cup of citric acid crystals instead of vinegar.

⚠ WARNING!

Dishwasher detergent is corrosive!
Take care to keep it out of reach of children.

Proper Use of Detergent

Use only detergent specifically made for use in dishwashers. Keep your detergent fresh and dry. Don't put powder detergent into the dispenser until you're ready to wash dishes.

RINSE AID DISPENSER

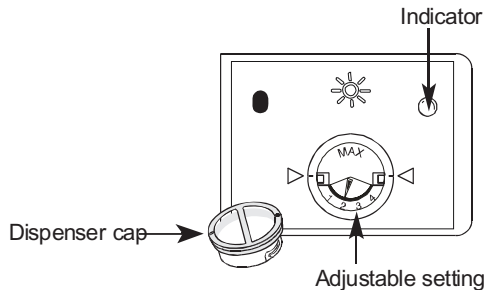

- To open the dispenser, turn the cap to the "open" (left) arrow and lift it out.
- Pour the rinse aid into the dispenser, being careful not to overfill.
- To replace, align cap with "open" arrow and turn clockwise to close.

- The rinse aid is released during the final rinse to prevent water from forming droplets on your dishes that can leave spots and streaks. It also improves drying by allowing water to "sheet" off the dishes.
- Your dishwashers are designed to use liquid rinse aids. The rinse aid dispenser is located inside the door next to the detergent dispenser. To fill the dispenser, open the cap and pour the rinse aid into the dispenser until the level indicator turns completely black. The dispenser holds about 100 ml of liquid rinse aid.
- Be careful not to overfill the dispenser, because this could cause over sudsing. Wipe away any spills with a damp cloth. Don't forget to replace the cap before you close the dishwasher door.
- If you have soft water, you may not need rinse aid for it may cause a white film to develop on your dishes.

Adjusting Rinse Aid Dispenser



Adjustable setting

A measured amount of rinse aid is released during the final rinse. As with detergent, the amount of rinse aid needed for your dishes depends on the hardness of the water in your area. Too much rinse aid can result in lather or foaming and cause cloudiness or streaks on your dishes. If the water in your area is very soft, you may not need rinse aid. If you do, you can dilute the rinse aid with an equal amount of water.

The rinse aid dispenser has four settings. Always start with the dispenser set on "2". If spots and poor drying are problems, increase the amount of rinse aid dispensed by removing the dispenser lid and rotating the dial to "3". If the dishes still are not drying properly or are spotted, adjust the dial to "4". Refill when the Rinse Aid Warning Light illuminates.

How To Use The All in1 Program

Your dishwasher has a "All-in-1 program" which needs no rinse aid but a "All-in-1" tablet.

NOTE: Only the All in1 program can be used with All in1 tablets. If you use All in1 tablets with other programs, The appliance will not achieve a good performance.

1. The figure below shows how to hang the All-in-1 tablet container on the upper basket.

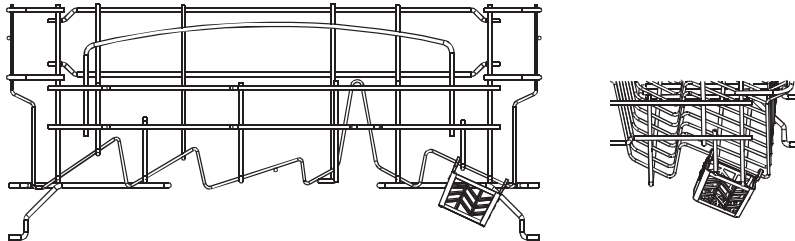

2. Rotate the upper sprayer and change the location of the container to ensure the upper sprayer is not obstructed by the All-in-1 tablet container. Refer to the figure below for reference.

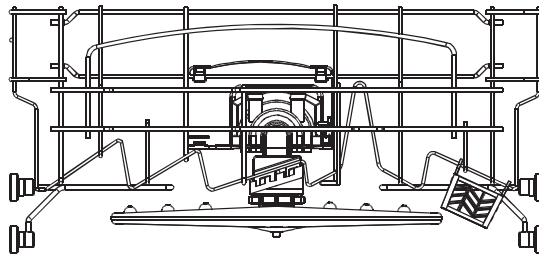

3. Put the All in1 tablet into the container, then start the All in1 program.

Loading the Dishwasher Racks.

For best performance of the dishwasher, follow these loading guidelines. Features and appearance of racks and silverware baskets may vary from your model.

How to use the Upper Rack

The upper rack is designed to hold more delicate and lighter dishware such as glasses, coffee and tea cup and saucers, as well as plates, small bowls and shallow pans (as long as they are not too dirty).

Position the dishes and cookware so that they do not get moved by the spray of water.

The upper rack can be adjusted for height by putting wheels of different height into the rails.

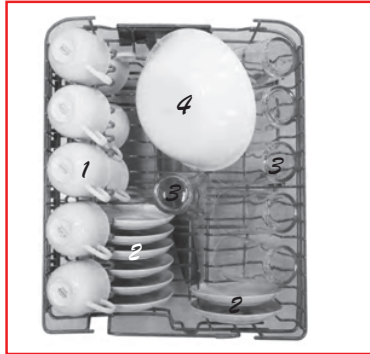

- 1 Cups
- 2 Saucer
- 3 Glasses

How to use the Lower Rack

We recommend that you place large items which are most difficult to clean into the lower rack: pots, pans, lids, serving dishes and bowls, as shown in the figure below.

It is preferable to place serving dishes and lids on the side of the racks in order to avoid blocking the rotation of the top spray arm.

- Pots, serving bowls, etc, must always be placed top down.
- Deep pots should be slanted to allow water to flow out.
- The bottom rack feature fold down tine rows so that larger or more pots and pans can be loaded.

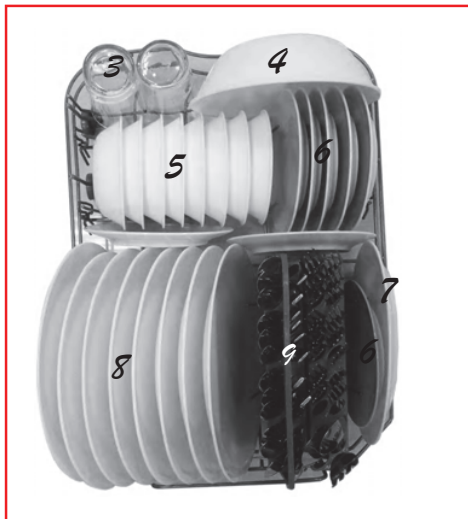

- 4 Serving bowl
- 5 Fruit bowl
- 6 Bread and butter plates
- 7 Serving plate
- 8 Dinner plates
- 9 Silverware basket

SILVERWARE BASKET

Silverware should be placed in the silverware basket with handles at the bottom: If the rack has side baskets, the spoon should be loaded individually into the appropriate slots, Especially long utensils should be placed in the horizontal position at the front of the upper rack.



2	4	5	1
	4	5	1
2	4	5	1
2	4	5	1
	4	5	1
2	4	5	4
2	4	5	7
	3	5	
2	3	3	1
2	3	3	1
2	3	6	6

1 Salad Forks

2 Teaspoons

3 Soup spoons

4 Dinner forks

5 Knife

6 Serving spoon

7 Serving fork



▲ WARNING!

Do not let any item extend through bottom.

Turning on the Appliance

Starting a wash cycle. . .

- 1 Make sure that the plug of the appliance is inserted into the wall socket.
- 2 Make sure that the water supply is turned on to full pressure.
- 3 Load the dishwasher(see the section entitled, " Loading the Dishwasher ").
- 4 Pour in the detergent(see the section entitled, "Detergent and Rinse Aid ").
- 5 Close the door,press the ON/OFF button,and the ON/OFF light will turn on.
- 6 Press the "prog button" to select the "Wash cycle".(see the section entitled."Wash Cycle Table".)
- 7 Press the start button, the washing will start after ten seconds.

Canceling or modifying a wash cycle setting. . .

Premise: A cycle that is underway can only be modified if it has only been running for a short time. Otherwise, the detergent may have already been released, and the appliance may have already drained the wash water. If this is the case, the detergent dispenser must be refilled (see the paragraph entitled " Loading the Detergent "). Open the door, Press the "Prog key-press" more than three second, then you can change the program to the desired cycle setting (see the section entitled, " Starting a wash cycle. . . "). Then, close the door.

At the End of the Wash Cycle

When the washing cycle has finished, the buzzer of dishwasher will buzz for eight second, then stop. Turn off the appliance using the ON/OFF button, open the door of the dishwasher. Wait a few minutes before unloading the dishwasher to avoid handling the dishes and utensils while they are still hot and more susceptible to breakage. They will also dry better.

Forget to Add a Dish?

A forgotten dish can be added any time before the detergent cup opens.

- 1 Open the door a little to pause the cycle.
- 2 After the spray arms stop working,you can open the door completely.
- 3 Add forgotten dishes.
- 4 Close the door, the dishwasher will work after ten second.

▲ WARNING!

It is dangerous to open the door when washing,because the hot water may be scalded to you.

Filtering System

For your convenience, we have placed the drain pump and filtering system within easy reach inside the tub. There are three components of the filtering system: the main filter, the coarse filter, and the fine filter.

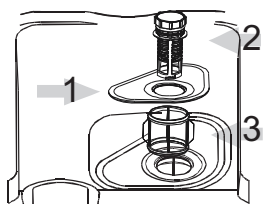

- 1 Main filter**
Food and soil particles trapped by this filter are pulverized by a special jet on the lower spray arm and washed down the drain.
- 2 Coarse filter**
Larger items, such as pieces of bone or glass, that could clog the drain are trapped in the coarse filter. To remove an item caught in this filter, gently squeeze the tabs on top of this filter and lift it out.
- 3 Fine filter**
This filter holds soil and food residue in the sump area and prevents it from being redeposited on the dishes during a cycle.

Caring for the Dishwasher

To clean the control panel use a lightly dampened cloth then dry thoroughly. To clean the exterior use a good appliance polish wax.

Never use sharp objects, scouring pads or harsh cleaners on any part of the dishwasher.

Protect Against Freezing

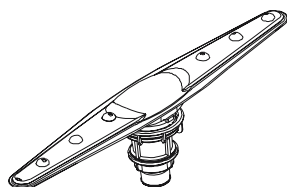

If your dishwasher is left in an unheated place during the winter, ask a service technician to:

- 1** Cut off electrical power to the dishwasher. Remove fuses or trip circuit breaker.
- 2** Turn off the water supply and disconnect the water inlet pipe from the water valve.
- 3** Drain water from the inlet pipe and water valve. (Use a pan to catch the water.)
- 4** Reconnect the water inlet pipe to the water valve.
- 5** Remove the plastic sump cover in the tub the bottom and use a sponge to soak up water in rubber boot.

Cleaning the Spray Arms

It is necessary to clean the spray arms regularly for hard water chemicals will clog the spray arm jets and bearings. To remove the spray arm, screw off the nut to take out the washer on top of the spray arm and remove the arm. Wash the arms in soapy and warm water and use a soft brush to clean the jets. Replace them after rinsing them thoroughly.

Cleaning the Filters

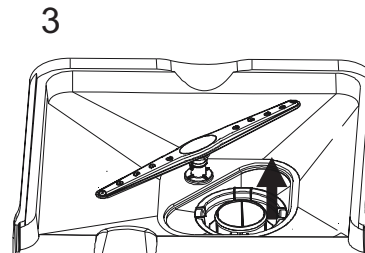
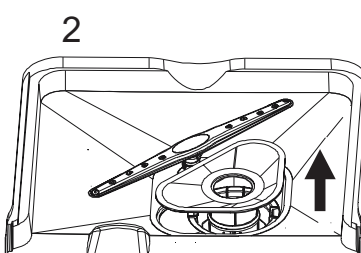
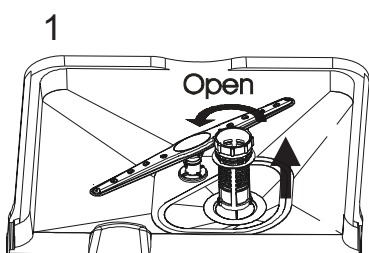

Step 1: Turn the filter in anti-clockwise direction, then lift it up.

Step 2: lift the Main filter up

Step 3: lift the Fine filter up

! NOTE: When following this procedure from step 1 to step 3, the filter system will be removed; when following it from Step 3 to Step 1, the filter system will be installed.

User-Maintenance Instructions

Cleaning the Door

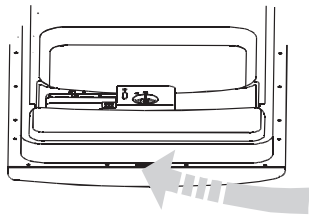

To clean the edge around the door, you should use only a soft warm, damp rag. To prevent penetration of water into the door lock and electrical components, do not use a spray cleaner of any kind.

Also, never use abrasive cleaners or scouring pads on the outer surfaces because they will scratch the finish. Some papers towels can also scratch or leave marks on the surface.

⚠ WARNING!

Never use a spray cleaner to clean the door panel for it could damage the door lock and electrical components. It is not allowed to use the abrasive agent or some paper towel because of the risk of scratching or leaving spots on the stainless steel surface.

How to Keep Your Dishwasher in Shape

■ **After Every Wash**

After every wash, turn off the water supply to the appliance and leave the door slightly ajar so that moisture and odors are not trapped inside.

■ **Remove the Plug**

Before cleaning or performing maintenance, always remove the plug from the socket. Do not run risks.

■ **No Solvents or Abrasive Cleaning**

To clean the exterior and rubber parts of the dishwasher, do not use solvents or abrasive cleaning products. Rather, use only a cloth and warm soapy water. To remove spots or stains from the surface of the interior, use a cloth dampened with water and a little white vinegar, or a cleaning product made specifically for dishwashers.

■ **When You Go on Holiday**

When you go on holiday, it is recommended that you run a wash cycle with the dishwasher empty and then remove the plug from the socket, turn off the water supply and leave the door of the appliance slightly ajar. This will help the seals last longer and prevent odors from forming within the appliance.

■ **Moving the Appliance**

If the appliance must be moved, try to keep it in the vertical position. If absolutely necessary, it can be positioned on its back.

■ **Seals**

One of the factors that cause odors to form in the dishwasher is food that remains trapped in the seals. Periodic cleaning with a damp sponge will prevent this from occurring.

About Electrical Connection

⚠ CAUTION, for personal safety:

DO NOT USE AN EXTENSION CORD OR AN ADAPTER PLUG WITH THIS APPLIANCE.
DO NOT, UNDER ANY CIRCUMSTANCES, CUT OR REMOVE THE THIRD GROUNDING PRONG FROM THE POWER CORD.

Electrical Requirements

This dishwasher is designed for operation on an adequately wired individual 110V, 60Hz. Use required fuse 15 amps. Fused electrical supply is required-copper wire only. Time delay fuse or circuit breaker recommended and provide separate circuit serving only this appliance. Outlet should be placed in adjacent cabinet.

Electrical Connection

⚠ WARNING!

Insure proper ground exists before use

After making sure that the voltage and the frequency values for the current in the home correspond to those on the rating plate and that the electrical system is sized for the maximum voltage on the rating plate, insert the plug into an electrical socket which is earthed properly. If the electrical socket to which the appliance must be connected is not appropriate for the plug, replace the socket, rather than using an adaptors or the like as they could cause overheating and burns.

User-Maintenance Instructions

Before Calling for service . . .

Troubleshooting Tips

Review the charts on the following pages may make you be free of calling for service.



<i>Problem</i>	<i>Possible Causes</i>	<i>What To Do</i>
<i>Dishwasher doesn't run</i>	Fuse blown, or the circuit breaker acted	Replace fuse or reset circuit breaker. Remove any other appliances sharing the same circuit with the dishwasher
	Power supply is not turned on	Make sure the dishwasher is turned on and the door is closed securely. Make sure the power cord is properly plugged into the wall socket.
	Water pressure is low	Check that the water supply is connected properly and the water is turned on.
<i>Noise</i>	Some audible sounds are normal	Sound from soft food shredding action and detergent cup opening.
	Utensils are not secure in the baskets or something small has dropped into the basket	To ensure everything is secured in the dishwasher.
	Motor hums	Dishwasher has not been used regularly. If you do not use it often, remember to set it to fill and pump out every week, which will help keep the seal moist.
<i>Suds in the tub</i>	Improper detergent	Use only the special dishwasher detergent to avoid suds. If this occurs, open the dishwasher and let suds evaporate. Add 1 gallon of cold water to the tub. Close and latch the dishwasher, then Start the wash cycle to drain out the water . Repeat if necessary.
	Spilled rinse agent	Always wipe up rinse agent spills immediately.
<i>Stained tub interior</i>	Detergent with colorant was used	Make sure that the detergent is the one without colorant.
<i>Dishes are not dried</i>	Rinse agent dispenser is empty	Make sure that the rinse agent dispense is filled.
<i>Dishes and flatware not clean</i>	Improper program	Select stronger program
	Improper rack loading	Make sure that the action of the detergent dispenser and spray arms are not blocked by large dishware.
<i>Spots and filming on glasses and flatware</i>	<ol style="list-style-type: none"> 1 Extremely hard water 2 Low inlet temperature 3 Overloading the dishwasher 4 Improper loading 5 Old or damp powder detergent 6 Empty rinse agent dispenser 7 Incorrect dosage of detergent 	<ul style="list-style-type: none"> • To remove spots from glassware: <ol style="list-style-type: none"> 1 Take out all metal utensils out of the dishwasher. 2 Do not add detergent. 3 Choose the longest cycle. 4 Start the dishwasher and allow it to run for about 18 to 22 minutes, then it will be in the main wash. 5 Open the door to pour 2 cups of white vinegar into the bottom of the dishwasher. 6 Close the door and let the dishwasher complete the cycle. If the vinegar does not work: Repeat as above, except use 1/4 cup (60 ml) of citric acid crystals instead of vinegar.

User-Maintenance Instructions

Before calling for service . . .

<i>Problem</i>	<i>Possible Causes</i>	<i>What To Do</i>
<i>Cloudiness on glassware</i>	Combination of soft water and too much detergent	Use less detergent if you have soft water and select a shorter cycle to wash the glassware and to get them clean.
<i>Yellow or brown film on inside surfaces</i>	Tea or coffee stains	using a solution of 1/2 cup of bleach and 3 cups warm water to remove the stains by hand. ▲ WARNING You have to wait for 20 minutes after a cycle to let the heating elements cool down before cleaning interior; to preven scalding.
	Iron deposits in water can cause an overall film	You have to call a water softener company for a special filter.
<i>White film on inside surface</i>	Hard water minerals	To clean the interior, use a damp sponge with dishwasher detergent and wear rubber gloves. Never use any other cleaner than dishwasher detergent for the risk of foaming or suds.
<i>Detergent cup lid won't latch</i>	Dial is not in the OFF position	Turn the Dial to OFF position and slide the door latch to the left.
<i>Detergent left in dispenser cups</i>	Dishes block detergent cups	Re-loading the dishes properly.
<i>Steam</i>	Normal phenomenon	There is some steam coming through the vent by the door latch during drying and water draining.
<i>Black or gray marks on dishes</i>	Aluminum utensils have rubbed against dishes	Use a mild abrasive cleaner to eliminate those marks.
<i>Water standing in the bottom of the tub</i>	This is normal	A small amount of clean water around the outlet on the tub bottom at the back of the tub keeps the water seal lubricated.
<i>Dishwasher leaks</i>	Overfill dispenser or rinse aid spills	Be careful not to overfill the rinse aid dispenser. Spilled rinse aid could cause oversudsing and lead to overflowing. Wipe away any spills with a damp cloth.
	Dishwasher isn't level	Make sure the dishwasher is level.



Your Guarantee

If this product is found to be faulty as a result of faulty materials or workmanship within one year from date of purchase, it will be repaired free of charge.

This guarantee is subject to the following terms:

- Sunpentown must be notified of the fault.
- Proof of purchase must be presented to Sunpentown nominated representative.
- The warranty will be void if the product is modified, misused or repaired by an unauthorized person.
- The warranty after repair will not be extended beyond the original one-year period.
- All replacement parts will be new or reconditioned.
- Parts, which are replaced, become the property of Sunpentown.
- The warranty applies for the use of the product in the USA only.

What is NOT COVERED:

- Warranty does not include freight charges.
- Incidental or consequential damage caused by possible defects with this product.
- Damage to product caused by improper power supply voltage, accident, fire, floods or acts of nature.
- Failure of product resulting from unauthorized modifications to the product.
- Improper installation or failure to perform the necessary maintenance.

This GUARANTEE is in addition to your Statutory Rights

SUNPENTOWN INTERNATIONAL INC.
14625 Clark Ave. City of Industry, CA 91745
Tel: 800-330-0388
service@sunpentown.com
www.sunpentown.com