

THE EXPERTS
IN ROOM AIR CONDITIONING







FRIEDRICH
1883

AjMadison
Your Appliance Authority™

WINDOW
THRU-THE-WALL
PORTABLE
HAZARDOUS LOCATION

800-570-3355



Window Air Conditioners  specifications 16	Thru-the-wall Air Conditioners  specifications 25
Portable Air Conditioners  specifications 28	Hazardous Location Air Conditioners  specifications 31

What type of air conditioner do you need?

	WINDOW AIR CONDITIONERS		THRU-THE-WALL		PORTABLE	HAZARDOUS LOCATION
	Kühl®	Chill™	WallMaster®	Uni-Fit®	ZoneAire®	Hazardgard®
PERMANENT INSTALLATION	Y	Y	Y	Y	—	Y
SEASONAL INSTALLATION	Y	Y	—	—	Y	—
CAN BE INSTALLED THRU-THE-WALL	Y	Y -except CP05	Y	Y	—	Y
ENERGY STAR®	Y	Y	Y	Y	NA	NA
POWER SUPPLY						
115V	Y	Y	Y	Y	Y	—
230V	Y	Y	Y	Y	—	Y
COOLING W/ HEAT						
HEAT PUMP	Y	—	Y	—	Y	—
ELECTRIC HEAT	Y	Y	Y	Y	—	—
EXTRA LARGE CAPACITY						
>17,000 Btu	Y	Y	—	—	—	Y
>25,000 Btu	Y	—	—	—	—	—
SPECIAL FEATURES						
ROLLS FROM ROOM TO ROOM	—	—	—	—	Y	—
SMARTGRID READY	Y*	—	—	—	—	—
ENHANCED FILTRATION	Y	—	—	—	—	—
DECORATOR COLORS	Y	—	—	—	—	—
OPTIONAL FEATURES						
WI-FI CONTROL	Y*	—	—	—	—	—
CREATE CUSTOM SCHEDULES	Y*	—	—	—	—	—
GROUP UNITS FOR CENTRALIZED CONTROL	Y*	—	—	—	—	—

*Requires FriedrichLink™ adapter accessory (sold separately).

WINDOW AIR CONDITIONER SELECTOR GUIDE

		COMMERCIAL GRADE		RESIDENTIAL GRADE	
		Kühl®	Kühl®+	Chill™	Chill™+
OVERVIEW	Description	Bold design and exclusive features. Programmability to rival central systems. Trusted Friedrich durability. Designer colors.	All the performance and durability of Kühl, plus heating. Choose efficient heat pump or toasty electric heat.	Good value. Available in a large range of cooling capacities. 24-hr. timer.	Good value. Four models with electric heat. 24-hr. timer.
	Room size (sq. ft.)	100-2700	350-2700	100-1500	100-1500
	Functions	COOL ❄️	HEAT/COOL ❄️🔥	COOL ❄️	HEAT/COOL ❄️🔥
	Applications	COMMERCIAL AND RESIDENTIAL	COMMERCIAL AND RESIDENTIAL	RESIDENTIAL AND LIGHT COMMERCIAL	RESIDENTIAL AND LIGHT COMMERCIAL
COMFORT & CONVENIENCE	Electronic controls	Y	Y	Y	Y
	Timer	7-day with up to 4 settings per day*; 24 hr. timer	7-day with up to 4 settings per day*; 24-hr. timer	24 hr.	24-hr.
	Remote control	LCD	LCD	LCD	LCD
	Control with smart phone or computer with FriedrichLink™ (accessory required)	Y	Y	—	—
	Auto-restart w/setting retention	Y	Y	Y	Y
	Auto temp/ fan speed adjustment	Y	Y	—	—
	Auto-changeover	—	All except EQ08	—	—
	Air flow directions	8	8	4	4
	Auto swing louvers	—	—	All except CP05	Y
Optional color fronts	Y	Y	—	—	
SOUND REDUCTION TECHNOLOGY	Steel inner wall and extra dense insulation	Y	Y	—	—
	Vibration isolating design and components	Y	Y	—	—
	Superior airflow design	Y	Y	—	—
EARTH FRIENDLY	ENERGY STAR® models	Y	Y	Y	Y
	Smart Grid capable	Y	Y	—	—
	Environmentally friendly R-410A	Y	Y	Y	Y
	Energy saver switch	Y	Y	Y	Y
	RoHS compliant	Y	Y	—	—
HEALTH	Washable, antimicrobial air filter	Y	Y	Y	Y
	Optional carbon filter	Y	Y	—	—
	Check filter reminder	Y	Y	—	—
	Superior fresh air intake/stale air exhaust	All except SQ & EQ models	All except EQ08	Stale air exhaust only, all except CP05	Stale air exhaust only
SAFETY	EntryGard™ anti-intrusion protection	Y	Y	Y	Y
	Insect barrier	Y	Y	—	—
INSTALLATION	Slideout chassis	Y	Y	All except CP05	Y
	Power cord direction	Left or right	Left or right	Left or right	Left or right
	Thru-the-wall installation option	Y	Y	All except CP05	Y
	Window installation hardware	Heavy duty	Heavy duty, available as accessory	Standard	Standard

*Requires internet connection and FriedrichLink™ accessory.

Product Selection Tools

These tools are only a guide. Due to variations in room design, local climate and occupancy, larger areas may require the use of multiple units to provide the optimal cooling solution. Please consult your local authorized Friedrich distributor or the Friedrich Technical Assistance team for sizing or application assistance.

COOLING SIZING GUIDE

The cooling guide to the right is based on normal room insulation, average number of sun-exposed windows and two-person occupancy.

HEATING SIZING INFORMATION

In heating mode, an energy efficient heat pump will generate slightly less heating Btus than it would in cooling mode. However, in heating mode, heat pumps use approximately 1/3 the energy of resistance heat, making them an excellent high-efficiency alternative. Back-up resistance heat ensures heat operation below 40° F outdoor temperatures for year 'round comfort.

Common Window Types

Traditional wooden windows are typical in many residences built before 1965, but more modern windows are often constructed of aluminum or vinyl. Many newer energy efficient windows like double-glazed windows actually sandwich low conductance gas between two panes of glass. While Friedrich air conditioners may be used with this type of window, care should be taken not to break the seal between the two panes of glass during installation.

Depending on the style of window in the application, you may want to consider the cooling solutions in the adjacent chart. Professional installers may be able to make field adaptations, including removing all or part of a window to support alternative types of air conditioning units. Professional installers should also be able to tell you about any local codes that may apply to your installation.

THRU-THE-WALL INSTALLATION

Many models may be installed through a wall so long as the unit's side vents are not blocked or covered in any way. See page 15, In-wall Installation max. depth.

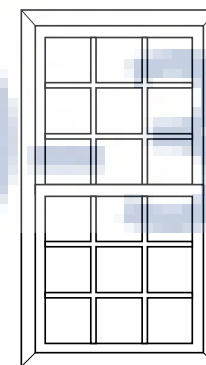

Single/double hung
(Opens up or down)

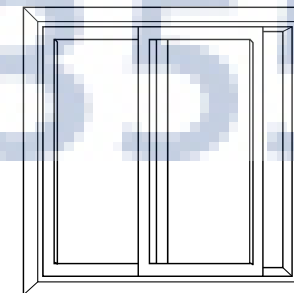

Slider
(Opens left to right, or right to left)

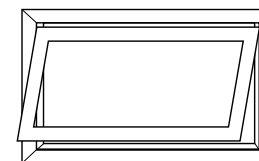

Awning
(Cranks out)

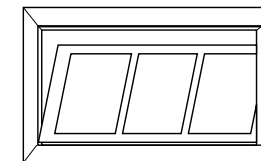

Hopper
(Opens in)

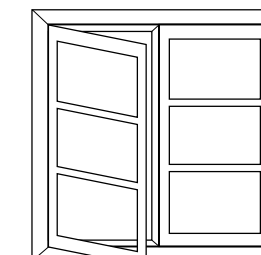

Casement
(Cranks out)

COOLING SIZING GUIDE

Area to be conditioned in sq. ft.	Cooling Btu
100 - 150	5000
150 - 250	6000
250 - 300	7000
300 - 350	8000
350 - 400	9000
400 - 450	10000
450 - 550	12000
550 - 700	14000
700 - 1000	18000
1000 - 1200	21000
1200 - 1400	23000
1400 - 1600	25000
1600 - 1900	28000
1900 - 2700	36000

WHICH AIR CONDITIONER IS RIGHT FOR YOU?

Window Type	Air Conditioner
Single/double hung	Window, portable, ductless
Slider	Window*, portable, ductless
Casement	Portable, ductless
Vertical Casement	Portable, ductless
Awning	Portable, ductless
Hopper	Portable, ductless
Picture (non-opening)	Thru-the-wall, ductless

*May require additional modifications

KÜHL® IS COMMERCIAL GRADE

IT'S TOUGH, DURABLE,
POWERFUL AND NOW IT'S
WIRELESS.

Kühl Construction.

For over 125 years, Friedrich products have been renowned for their commercial-grade, built-to-last design.

Advanced engineering, high-end materials and components, and rigorous product testing are just a few examples of Friedrich's commitment to quality. When designing Kühl, our engineers challenged convention to develop the very best window air conditioner on the market. Kühl incorporates high-end materials like heavy-gauge galvanized steel, rifled copper tubing, and high-tech aluminum fins.

Kühl also uses the most durable components to extend the life of your air conditioner, including fully -enclosed fan motors that seal out dirt, and powerful, energy-efficient compressors, which make Kühl as tough an air conditioner as we've ever built.

Kühl Quiet.

Kühl has been engineered for quiet operation. Materials have been chosen because of their sound-absorption properties and every moving part has been braced and insulated. For example, extra thick rubber grommets absorb vibration and reduce noise inside, while steel inner walls and extra dense insulation block outdoor noise.

Rugged hardboard side panels help reduce noise and keep out light. The unique air path is more streamlined, drawing air through the sides, away from moving parts. And our larger discharge vents allow for smoother airflow, delivering maximum conditioned air quietly.

Kühl Comfort.

The most comfortable temperature is the one you never notice. Kühl uses multiple built-in environmental sensors to more accurately monitor indoor and outdoor temperatures so that it can maintain your ideal settings.

Kühl+ models have the ability to cool or heat as needed so units can operate year-round. And, like the most advanced central systems, Kühl+ automatically switches between air conditioning and heating functions to maintain the desired comfort level. You won't have to lift a finger.

Plus, Kühl's air flow systems are tested for powerful and precise air distribution which means faster cooling when you need it most.

800-570-3355

KÜHL CONSTRUCTION



Kühl® Series



COMMERCIAL GRADE



COLOR YOUR WORLD

With six Kühl colors. Change your Kühl's appearance to complement your color scheme or to add a splash of color



Neutral Gray (STANDARD)



Black Onyx

Pink Diamond

Deep Red

Classic Beige

Cobalt Blue

Designer White

KÜHL'S STREAMLINED MODERN DESIGN IN NEUTRAL GRAY CAN BLEND IN WITH ANY DÉCOR. OR COORDINATE A LOOK THAT COMPLEMENTS YOUR SPACE BY USING ANY OF THE SIX COLORED FRONT COVERS.

KÜHL® YOUR WORLD

Whenever. Wherever. Kühl is Wi-Fi enabled so you can control the comfort in your home from a smartphone, tablet or computer.



WI-FI OPERATION (requires optional accessory sold separately)
Kühl units can be controlled remotely over a Wi-Fi network using FriedrichLink™ Wif-Fi Adapter Accessory.

A web-based control portal on Friedrich.com allows you to access units for monitoring or control.



With Kühl you can choose from simple ON/OFF operation of a single unit to advanced programming and scheduling.

SIMPLE OPERATION

Turn the unit on, select 'MODE' and make simple up/down temperature adjustments either at the control panel or with included remote.

BUILT-IN 7 DAY SCHEDULES

Kühl units include two 7-day energy management schedules which can be accessed and selected from the unit's controls.

The 'Residential' schedule causes Kühl to raise the room temperature temporarily during the hours when most people are away at work and lower them again prior to the time when most people will return home.

The 'Commercial' schedule tells the unit to raise temperatures after typical working hours and on weekends when commercial spaces are typically unoccupied.

CUSTOM 7-DAY SCHEDULE (requires optional accessory sold separately)

Create up to 5 custom programs that you can use to operate your Kühl air conditioner for maximum comfort and efficiency. Each 7-day program allows up to 4 setting changes per day.

See <http://friedrichlink.friedrich.com> for more details.



SMART GRID CAPABLE

Kühl is the first room air conditioner that can tie into a power company's smart grid.

A grid is a network that brings electricity from power stations to consumers. New technologies allow power companies to adjust electrical loads of residential users based on their specific needs - this is called a 'smart grid'. Smart grid helps consumers to be better informed about their electricity usage and allows electric utility companies to serve customer demand in the most efficient way.

For example, during a hot summer afternoon when AC units are running at full capacity, the smart grid can send information to recalibrate other loads, which helps to alleviate stress on the system as a whole.

Source: SGIC (Smart Grid Information Clearinghouse)

KÜHL COLORS

KÜHL CONTROL



If you have a room that is too cold in winter, too hot in summer, adding a Kühl+ model is the perfect solution.



WINDOW AIR CONDITIONERS



Kühl® ULTRA PREMIUM LINE

Experience the control and convenience of a central air conditioning system in ways you never thought possible.

You'll find more options, features and ways to customize your cooling experience than you ever thought possible in a window air conditioning solution.

NEW smaller size

FITS WINDOWS FROM 22" TO 42" WIDE



Neutral Gray (STANDARD)



Kühl®
5400-9600 Btu
Up to 11.2 EER

Kühl+
Electric Heat
COOLING
7600 Btu
Up to 10.5 EER
ELECTRIC HEAT
4000 Btu



Full LCD display shows MODE, FAN SPEED, SET TEMPERATURE and SCHEDULE. Adjust TEMPERATURE and FAN SPEEDS, set AUTO MODE and turn the SCHEDULE ON/OFF.

FITS WINDOWS FROM 27 3/8" TO 42" WIDE



Neutral Gray (STANDARD)



Kühl®
7900-36000 Btu
Up to 11.2 EER

Kühl+
Electric Heat
COOLING
7600-36000 Btu
Up to 10.9 EER
ELECTRIC HEAT
4000-17300 Btu

Kühl+
Heat Pump
COOLING
9500-23500 Btu
Up to 10.5 EER
HEATING
8000-23500 Btu

KÜHL® FEATURES

Comfort & Convenience

- Convenient control from your smartphone, tablet or computer via FriedrichLink™ (required accessory sold separately)
- 2 ready-to-go 7-day energy management programs*
- Create customizable, 7-day schedules with up to 4 setting changes per day (requires accessory, sold separately)
- 24-hour timer
- Up to 4 cooling and 4 fan-only speeds on select models
- Automatic fan speed adjustment
- Auto-changeover from cool to heat; heat to cool to maintain set temperature (Kühl+ models except EQ08)
- 8-way air flow control
- Temperature readout can display set temperature and room temperature
- Control panel lockout (ON/OFF)
- LCD panel auto dims if not in use
- Nightlight mode

Superior Sound Reduction Technology

- Steel inner wall and extra dense insulation materials block outdoor noise
- Vibration isolating design and components diminish traditional operating noise
- Precision engineering maximizes air flow while delivering ultraquiet operation

Superior Filtration

- Superior fresh air intake and stale air exhaust vent*
- Washable, antimicrobial air filter
- Check filter reminder
- Optional premium filter when used in conjunction with standard filter provides superior air filtration with ratings as high as MERV 6, while also adsorbing odors and reducing ozone and VOCs
- Hinged door for easy filter access for easier maintenance

Durable

- Robust 20 gauge steel cabinet
- Solid-sleeve top keeps out falling debris*
- Solid-steel blower housing offers enhanced protection
- Totally enclosed commercial grade fan motor runs at a lower temperature to prevent overheating and is double-mounted for added stability and reduced wear
- Durable base pan and steel inner walls
- Unit's structural integrity allows it to be removed, cleaned and maintained outside of its sleeve
- Aluminum rear grille protects the outdoor coil from damaging debris and vandalism
- Aluminum end plates will not contribute to rust-stained building exteriors
- Scratch-resistant cabinet
- High-tech aluminum fins with rifled copper tubing are more efficient and less prone to corrosion
- Heavy-duty installation hardware lasts longer and provides a superior barrier from the outside elements

Installation Features

- Install in a window or thru-the-wall
- Slideout chassis for more permanent installation and easier access for maintenance
- Includes heavy duty window installation hardware (optional accessory on Kühl+ models sold separately)
- Rugged hardboard side panels or (heavy duty side curtains on SQ and EQ models) for a more permanent installation
- Power cord can run either left or right
- Firm grip handles for easier chassis installation and removal
- Front cover attaches easily and securely. Nut driver included**.

Earth Friendly

- Smart Grid capable
- Auto Fan mode saves money by conserving energy
- ENERGY STAR® qualified models, including heat pumps
- Environmentally-friendly R-410A refrigerant used in all models
- Recyclable packaging
- RoHS compliant

Safety & Security Features

- EntryGard™ anti-intrusion protection-steel retaining wire secures the chassis to the sleeve to deter 'kick-in' intrusion
- Powercord leakage current protected
- Insect barrier*
- Protective rear grille

KÜHL® ACCESSORIES

FRIEDRICHLINK™ ADAPTER

Wi-Fi Adapter Accessory connects to unit to allow for remote wireless access and programming from a computer, tablet or mobile device

Model	Kit No.
N Series	KWIFI



PREMIUM CARBON FILTERS

Remove odors and VOCs (volatile organic compounds). Achieve up to a MERV 6 rating when used with standard filter. 3 pk.



Model	Kit No.
SQ and EQ	KWCFCQ
SS, ES and YS	KWCFS
SM, EM and YM	KWCFCM
SL, EL and YL	KWCFL

WINDOW MOUNTING KITS: KÜHL+

Heavy duty kits required for installation of these Kühl+ models in a window.

Heat/Cool Models	Kit No.
EQ08N11*	KWIKQ
ES12N33, ES16N33, YS10N10A and YS12N33.	KWIKS
EM18N34, EM24N34A and YM18N34.	KWIKM
EL36N35 and YL24N35.	KWIKL



KWIKQ

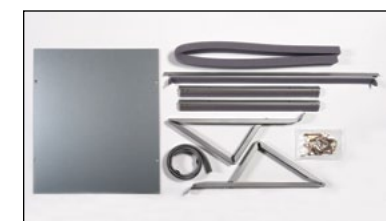

KWIKS, KWIKM, KWIKL

COLORED FRONT COVERS

Colored front cover kits available in six colors.



Deep Red



Cobalt Blue



Classic Beige



Designer White



Black Onyx



Pink Diamond

Model	COLOR					
	Deep Red	Cobalt Blue	Classic Beige	Designer White	Black Onyx	Pink Diamond
SQ and EQ	KWREDA	KWBLUA	KWBGQA	KWWHTA	KWBLQA	KWPNGA
SS, ES and YS	KWREDA	KWBLUA	KWBGQA	KWWHTA	KWBLQA	KWPNGA
SM, EM and YM	KWREDA	KWBLUA	KWBGQA	KWWHTA	KWBLQA	KWPNGA
SL, EL and YL	KWREDA	KWBLUA	KWBGQA	KWWHTA	KWBLQA	KWPNGA

DRAIN KIT

Drain tube field installed to the bottom on the base pan.

Model	Kit No.
All Kühl Series Models	DC2



*Feature not available on Kühl SQ and EQ models. **Nut driver not required for Kühl SQ and EQ models.

*EQ08N11 window kit KWIKQ does not include window brackets.





CHILL™ SLEEK DESIGN

And outstanding efficiency
Available in a range of capacities
with convenience features for
carefree cooling and heating.

WINDOW AIR CONDITIONERS

FITS WINDOWS FROM
20 1/8" TO 36" WIDE

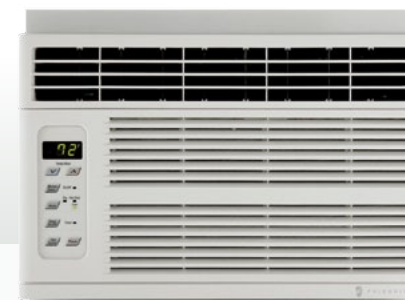

CP05

Chill™
5450 Btu
10.7 EER



COOL



Select MODE, FAN SPEED,
adjust TEMPERATURE and set
the TIMER.

CHILL™ SERIES PREMIUM LINE

Sleek white design and energy efficient operation, including heat/cool models.

Our efficient
line of room air
conditioners with
programmable
controls for
convenient
operation

AjMadison
Your Appliance Authority™

AUTO AIR SWEEP SWING
LOUVERS FOR EVEN COOLING
THROUGHOUT THE ROOM.



FITS WINDOWS FROM
20 1/8" TO 42" WIDE

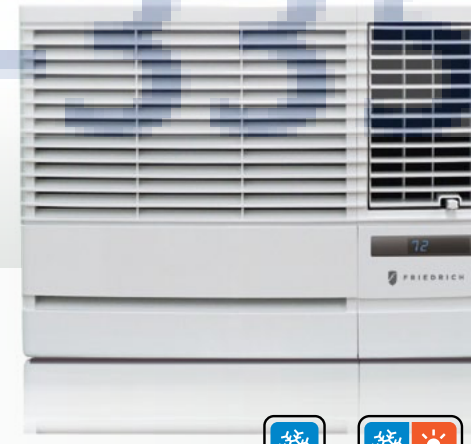

COOL



COOL & HEAT

Chill™
6000-23500 Btu
Up to 10.8 EER

Chill™+
Electric Heat
COOLING
8000-23500 Btu
Up to 9.8 EER

ELECTRIC HEAT
3850-12000 Btu

Comfort & Convenience

- 24-hour timer
- Auto air sweep swing louvers* provide more even air distribution
- 3 cooling speeds, plus 3 fan-only settings; 2 cooling speeds, 2 heating speeds, plus fan-only setting on Chill+
- Ultraquiet operation
- 4-way air flow control
- Auto-restart saves settings if power is interrupted

Earth Friendly

- ENERGY STAR® qualified models
- Money Saver® setting saves money by operating the fan only when cooling

Health

- Washable, antimicrobial air filter
- Stale air exhaust

Installation Features

- Slideout chassis*
- Install in window or thru-wall**
- Standard installation hardware
- Expandable side curtains
- Power cord can run either left or right out of the side of the unit front*

Safety & Security Features

- EntryGard™ anti-intrusion protection

* Feature not available on CP05.
** CP05 has a fixed chassis and is for window installation only.



Money Saver®
feature saves
energy by cycling
the fan with the
compressor



SPECIFICATIONS



Model	Cooling Btu	Heating Btu	Volts Rated	Cooling Amps	Cooling Watts	Heating Amps	Heating Watts	Energy Efficiency Ratio EER	Estimated Yearly Operating Cost	Moisture Removal-Pints/HR	CFM	Sleeve	Net Wt. lbs.	Ship lbs.	
Kühl®															
★ SQ05N10	5400	-	115	4.9	482	-	-	11.2	\$38	-	0.5	190	Q	72	85
★ SQ06N10	5800	-	115	4.9	527	-	-	11	\$42	-	0.5	190	Q	72	85
★ SQ08N10	8000	-	115	6.6	741	-	-	10.8	\$59	-	1.2	240	Q	71	84
★ SQ10N10	9600	-	115	9.2	980	-	-	9.8	\$78	-	2.1	240	Q	71	84
★ SS08N10A	7900	-	115	6.6	731	-	-	10.8	\$58	-	1.5	255	S	99	121
★ SS10N10	9500	-	115	7.7	848	-	-	11.2	\$67	-	2.5	300	S	106	128
★ SS12N10	12000	-	115	10	1111	-	-	10.8	\$88	-	3.0	300	S	112	134
★ SS14N10A	13500	-	115	10.8	1250	-	-	10.8	\$100	-	4.0	275	S	116	133
★ SS12N30	11500/11200	-	230/208	4.8/4.9	1055/1027	-	-	10.9/10.9	\$84	-	2.8	275	S	112	134
★ SS16N30	15500/15200	-	230/208	6.5/7.1	1449/1421	-	-	10.7/10.7	\$116	-	4.8	350	S	116	136
★ SM15N10	14800	-	115	12.0	1358	-	-	10.9	\$108	-	3.5	360	M	141	154
★ SM18N30	17500/17200	-	230/208	7.4/8.0	1635/1607	-	-	10.7/10.7	\$130	-	4.6	350	M	140	161
★ SM21N30	20500/20000	-	230/208	9.4/10.3	2181/2128	-	-	9.4/9.4	\$173	-	6.0	425	M	132	153
★ SM24N30A	23500/23200	-	230/208	12.7/13.6	2765/2730	-	-	8.5/8.5	\$221	-	7.1	430	M	152	167
★ SL24N30	24000/23800	-	230/208	11.2/12.0	2553/2532	-	-	9.4/9.4	\$203	-	7.0	640	L	191	212
★ SL28N30	27500/27000	-	230/208	13.5/14.4	2926/2872	-	-	9.4/9.4	\$233	-	8.5	640	L	193	214
★ SL36N30	36000/35700	-	230/208	19/20.5	4235/4200	-	-	8.5/8.5	\$337	-	12.0	725	L	212	233
Kühl® + (Heat Pump)															
★ YS10N10A*	9500	8000	115	6.4	915	7.3	870	10.4	\$73	2.7	2.0	300	S	109	131
★ YS12N33	11500/11300	9400/9000	230/208	5.2/5.4	1095/1076	5.6/5.8	1132/1139	10.5/10.5	\$87	2.4/2.3	3.0	375	S	115	136
★ YM18N34	17900/17700	15500/15400	230/208	8.5/8.9	1808/1788	8.5/8.7	1833/1761	9.9/9.9	\$144	2.5/2.6	5.4	370	M	141	154
★ YL24N35	23500/23000	23500/23200	230/208	11.1/12.0	2500/2447	12.2/14.3	2610/2575	9.4/9.4	\$199	2.6/2.6	7.0	600	L	197	211
Kühl®+ (Electric Heat)															
★ EQ08N11	7600	4000	115	6.7	724	11.2	1290	10.5	\$58	-	1.9	175	Q	72	84
★ ES12N33	11500/11200	10700/8900	230/208	4.8/4.9	1055/1027	16.0/14.7	3500/2900	10.9/10.9	\$84	-	2.8	275	S	113	128
★ ES16N33	15500/15200	10700/8900	230/208	6.5/7.1	1449/1421	16.0/14.7	3500/2900	10.7/10.7	\$116	-	4.8	350	S	117	133
★ EM18N34	17500/17200	13000/10600	230/208	7.4/8.0	1635/1607	19.5/17	4200/3500	10.7/10.7	\$131	-	4.6	350	M	141	154
★ EM24N34A	23500/23200	13000/10600	230/208	12.7/13.6	2765/2730	19.5/17	4200/3500	8.5/8.5	\$221	-	7.1	430	M	153	166
★ EL36N35	36000/35700	17300/14300	230/208	19/20.5	4235/4200	24.0/22.4	5500/4650	8.5/8.5	\$338	-	12.0	725	L	213	225
Chill™ (Cool Only)															
★ CP05G10	5450	-	115	4.8	500	-	-	10.7	\$40	-	1.5	140	P1	46	50
★ CP06G10	6000	-	115	5.1	560	-	-	10.7	\$45	-	1.8	200	P6	60	66
★ CP08G10	7800	-	115	6.8	720	-	-	10.8	\$58	-	2.2	250	P6	64	70
★ CP10G10	10000	-	115	8.5	920	-	-	10.8	\$73	-	3.0	300	P7	81	87
★ CP12G10	12000	-	115	10.2	1110	-	-	10.8	\$89	-	3.3	330	P7	87	93
★ CP15G10	15000	-	115	12.9	1400	-	-	10.7	\$112	-	4.0	400	P8	120	134
★ CP18G30	18000/17500	-	230/208	7.6/8.1	1680/1630	-	-	10.7/10.7	\$134	-	4.5	520	P9	136	150
★ CP24G30	23500/23000	-	230/208	11.4/12.4	2500/2450	-	-	9.4/9.4	\$196	-	6.8	590	P9	146	160
Chill™+ (Electric Heat)															
★ EP08G11	8000	3850	115	7.5	820	11.0	1260	9.8	\$65	-	2.6	265	P7	79	85
★ EP12G33	12000/11500	11200/9200	230/208	5.5/5.8	1220/1170	15.3/14.0	3500/2900	9.8/9.8	\$97	-	3.3	265	P7	87	93
★ EP18G33	18000/17500	12000/9800	230/208	8.3/9.0	1850/1800	15.0/16.0	3670/3100	9.7/9.7	\$148	-	5.5	430	P9	136	150
★ EP24G33	23500/23000	12000/9800	230/208	12.2/13.2	2760/2700	15.0/16.0	3670/3100	8.5/8.5	\$220	-	6.5	560	P9	146	160

* Operates on 115 volt and is not equipped with supplemental heat. Will not provide heat at temperatures below 40°F. Friedrich room air conditioners are designed to operate in outdoor temperatures from 60°F to 115°F.

Kühl+ Heat Pump heating information (shown in red) indicates heat pump performance. Kühl+ and Chill+ Electric Heat heating information (shown in red) indicates electric heat strip performance. For Kühl+ Heat Pump electric heating performance refer to corresponding Kühl+ Electric Heat model.

As an ENERGY STAR® partner, Friedrich Air Conditioning Co. has determined that the selected ENERGY STAR® models meet the ENERGY STAR® guidelines for energy efficiency.

The consumer- through the AHAM Room Air Conditioner Certification Program- can be certain that the AHAM Certification Seal accurately states the unit's cooling and heating capacity rating, the amperes and the energy efficiency ratio.

Estimated yearly operating cost based on a 2007 national average electricity cost of 10.65 cents per kWh.

Due to continuing research in new energy-saving technology, specifications are subject to change without notice.



INSTALLATION INFORMATION/SLEEVE DIMENSIONS

Sleeve	Height INCHES	Width INCHES	Depth with Front INCHES	Shell Depth to Louvers INCHES	Minimum Extension Into Room* INCHES	Minimum Extension Outside * INCHES	Window Width INCHES		In-wall Installation Finished Hole INCHES			Carton Dimensions INCHES		
			A	B			Minimum**	Maximum	Height	Width	Max. Depth C	Height	Width	Depth
Q	14"	19 3/4"	21 3/8"	8 1/2"	5 1/2"	10 3/4"	22"	42"	14 1/4"	20"	8 1/2"	18 3/4"	25 1/2"	22 3/4"
P1†	12"	18 1/2"	15"	5"	3 1/2"	10 3/4"	20 1/8"	36"	NOT FOR THRU-WALL			15 1/4"	22 1/4"	17 1/2"
P6	14"	18 3/8"	20 7/8"	8 1/8"	4 1/2"	11"	20 1/8"	36"	14 1/8"	18 7/8"	7 1/2"	17 7/8"	22 3/4"	22"
P7	15"	23 5/8"	21 3/4"	8 3/4"	4 1/2"	12"	25 1/4"	39"	15 1/4"	23 7/8"	8"	18 3/4"	26 3/4"	23 7/8"
P8	16 7/8"	26"	26 7/8"	10 1/4"	5 1/2"	16 5/8"	26 1/2"	42"	17 1/8"	26 1/4"	9"	21 1/2"	29 1/2"	29"
P9	16 7/8"	26"	30 3/8"	10 1/4"	5 1/2"	19 1/2"	26 1/2"	42"	17 1/8"	26 1/4"	9"	21 1/2"	33"	28 7/8"
S	15 15/16"	25 15/16"	29"	8 3/4"	5 3/4"	16 15/16"	27 3/8"	42"	16 3/16"	26 3/16"	7 3/8"	19"	34 1/2"	29"
M	17 15/16"	25 15/16"	29"	8 3/4"	5 3/4"	16 15/16"	27 3/8"	42"	18 3/16"	26 3/16"	7 3/8"	21"	34 1/2"	29"
L	20 3/16"	28"	35 1/2"	16 1/2"	5 3/8"	18 15/16"	29 7/8"	42"	20 3/8"	28 1/4"	15 1/8"	24 1/2"	38 7/8"	31 5/8"

* Minimum extensions when mounted in a window.
 ** Minimum widths achieved using one side curtain assembly as opposed to both in a standard installation.
 † Sleeve P1 does not have in-wall hole dimensions, as these units are fixed chassis and should not be installed in-wall.
 NOTE: S, M and L sleeves may be installed in window with no side kits if properly installed.

Circuit Rating/ Breaker

Model	Circuit Rating Breaker or T-D Fuse	Plug Face (NEMA#)	Power Cord Length (ft.)	Wall Outlet Appearance
CP05			6 1/2	
CP06G10, CP08G10, CP10G10, CP12G10 and CP15G10. EP08G11. All SQ MODELS. EQ08N11. SS08N10A, SS10N10, SS12N10 and SS14N10A. YS10N10A.	125V - 15A	5 - 15P	6	
CP18G30			4	
SS12N30, SS16N30, SM16N10, SM18N30 and SM21N30.	250V - 15A	6 - 15P	4 1/2	
CP24G30.			4	
EP12G33, EP18G33, EP24G33				
SM24N30A. SL24N30 and SL28N30. ES12N33 and ES16N33. YS12N33.	250V - 20A	6 - 20P	6	
SL36N30. EM18N34, EM24N34A and EL36N35. YM18N34 and YL24N35.	250V - 30A	6 - 30P	6	

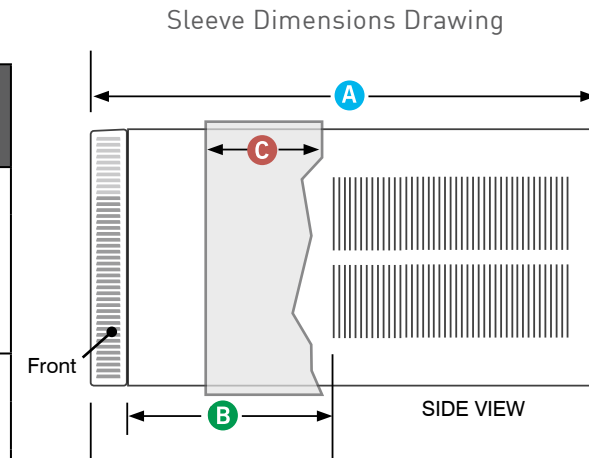

Room Air Conditioner Model Identification Guide

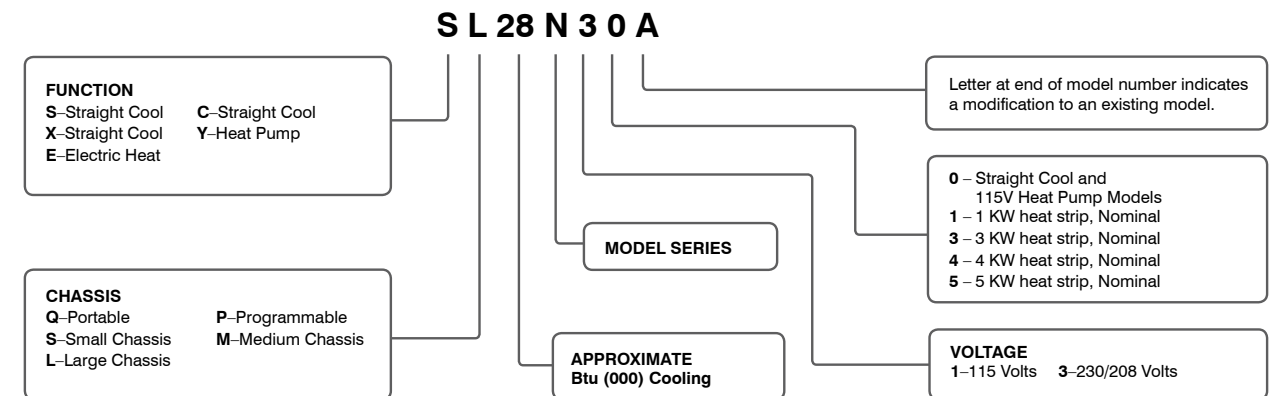

THRU-THE-WALL AIR CONDITIONER GUIDE

When should you install a solid side sleeve?

A solid-side wall sleeve allows for installation in thick exterior walls where the installation of room air units with side vents would effect performance and may even void the warranty.

ROOM AIR CONDITIONER
Blocked side vents restrict air flow

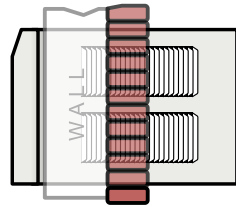

FRIEDRICH THRU-THE-WALL
Solid-side sleeve (no side vents) can be installed in thicker walls. Sleeve can be positioned flush with exterior wall.

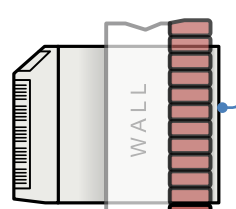

Or with minimum intrusion into the room.

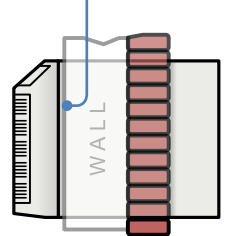

		THRU-THE-WALL MODELS	
		WallMaster®	Uni-Fit®
OVERVIEW	Sleeve size	Fits 27" sleeves	Fits 26" sleeves and sleeves as small as 24 1/2"
	Applications	RESIDENTIAL OR LIGHT COMMERCIAL	RESIDENTIAL OR LIGHT COMMERCIAL
COMFORT & CONVENIENCE	Perfect fit for Fedders' 27" sleeves	Y	—
	Top mounted controls	Y	—
	Electronic controls	Y	Y
	Programmable timer	24 hr.	12 hr.
	Remote control	Y	Y
	Auto restart when power is interrupted	Y	Y
	Smart Fan auto adjusting fan	Y	—
	Upward angled air discharge	Y	—
	Air flow direction control	4-way	6-way
Fan speeds	3	3	
SOUND REDUCTION TECHNOLOGY	Steel inner wall and extra dense insulation	Y	Steel inner wall
	Vibration-isolating design and components	Y	Y
	Superior airflow design	Y	—
EARTH FRIENDLY	ENERGY STAR® models	Y	Y
	Environmentally friendly R-410A	Y	Y
	Energy saver switch	Y	Y
HEALTH	Washable, antimicrobial air filter	Y	Y
	Stale air exhaust	—	Y
SAFETY	EntryGard™ anti-intrusion protection	Y	—
	Insect barrier	Y	—
INSTALLATION	Slideout chassis	Y	Y
	Power cord direction	Left	Right
	Concealed power cord option	Y	—
	Internal drain kit option	Y	—
	Baffle adapter kit for installation in Fedders 'B' sleeve	Y	—
	Condensate drain kit	Y	—

THRU-THE-WALL UNITS IN TWO SIZES.

Fit many competitor's sleeves
Upgrade your old inefficient units with Friedrich Wallmaster® and Uni-Fit® thru-the-wall air conditioners.



THE BEST OPTION FOR DEEP WALL INSTALLATIONS

Energy efficient solid-side air conditioners, heat pumps and electric heat models.

Madison
Your Appliance Authority™
800-570-3355



WallMaster®



Uni-Fit®



WALLMASTER®. A PERFECT FIT IN FRIEDRICH AND COMPETITOR'S 27" SLEEVES.

Commercial grade quality unit is ideal for installation in new construction, retrofits and remodels.

Perfect fit in 27" wall sleeves, including Fedders A and B* sleeves.

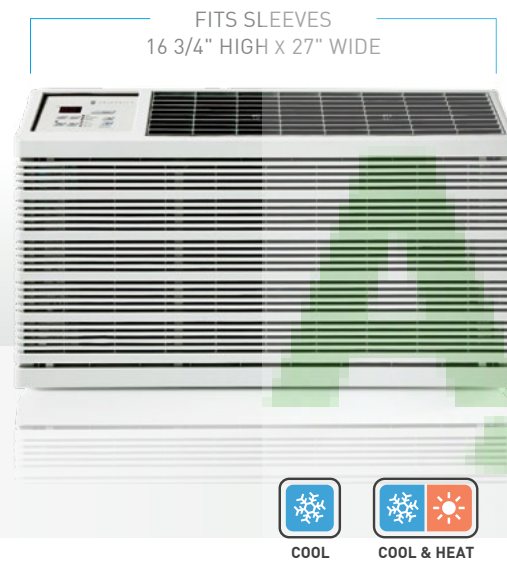

Select MODE, FAN SPEED, adjust TEMPERATURE and set the TIMER.

WallMaster®
7800-15600 Btu
Up to 9.9 EER

WallMaster® Electric Heat
COOLING
9500-15600 Btu
Up to 9.6 EER
ELECTRIC HEAT
9100-11000 Btu

WallMaster® Heat Pump
COOLING
9300-12000 Btu
Up to 9.4 EER
HEATING
7300-9350 Btu

WALLMASTER® FEATURES

Comfort & Convenience

- Easy-to-reach, top mount controls
- Remote control
- 24-hour timer
- Smart Fan auto-adjusts fan speed to maintain desired temperature
- 3-speed fan
- Auto restart
- Electronic defrost control
- Reversible louver allows a second airflow option

Energy Management and Compliance

- Money Saver® setting saves money by operating the fan only when needed
- ENERGY STAR® qualified models
- R-410A refrigerant

Health and IAQ

- Washable, antimicrobial filter

Durability & Quality

- Rotary compressors provide quiet, dependable performance
- Premium aluminum exterior grille
- Dense blower insulation
- Rifled copper tubing
- Impact resistant front cover
- High tech fins with sine wave lanced louvers increase energy efficiency by increasing surface area for heat exchange



Rifled copper tubing



Sine wave lanced louvers

Safety & Security

- EntryGard™ anti-intrusion protection secures chassis to sleeve to deter 'kick-in' intrusion
- Power cord current leakage protected
- Insect barrier

Maintenance and Installation Features

- Mounts flush with the exterior wall for a neat appearance
- Ideal for thicker wall installations, where side fins don't fit
- Reversible louver allows for a second airflow option
- A high efficiency replacement for 27" sleeves including Fedders A and B*. Sleeve measures 27" W x 16 3/4" H

Accessories

- WSD sleeve, ships with inside and outside weather panel and standard grille
- AG architectural grille for use with WSD sleeve
- Baffle adapter kit for use with deep sleeve installations
- Drain kit for condensate disposal
- Internal drain kit for new construction applications where condensate drain system is built-in



Angled air discharge for superior air distribution when the unit is installed low on a wall. Reversible louver for a second air flow option.

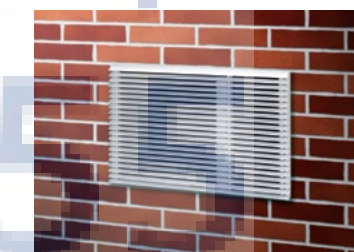

Sleeve can be installed flush with the exterior wall. Optional AG architectural grille shown.

NOTE: Chassis requires WSD sleeve for new installations (sold and shipped separately)

WSD wall sleeve ships with weather panels and grille.

Sleeve is shown at right with standard galvanized steel inner panel, painted steel outer panel and standard grille



Inner steel weather panel.



WSD sleeve.



Outer weather panel



Standard grille

Fits Fedders A & B sleeves. *B sleeve installations require BAK accessory, baffle adapter kit.

WallMaster® fits existing Fedders sleeves.

Sleeve Dimensions	Friedrich WSD Sleeve	Fedders A Sleeve	Fedders B Sleeve*
Height (inches)	16 3/4	16 3/4	16 3/4
Width (inches)	27	27	27
Depth (inches)	16 3/4	16 3/4	19 3/4

Chassis requires WSD sleeve (sold and shipped separately)
*Installation in Fedders B sleeve requires a baffle kit. See BAK accessory under accessories.



THRU-THE-WALL AIR CONDITIONERS

UNI-FIT® UNIVERSAL FIT FOR EASY REPLACEMENT IN EXISTING 24 1/2", 26" OR 27" SLEEVES.

Residential grade quality for installation in new construction, retrofits and remodels.



FITS SLEEVES
24 1/2", 26" AND 27" WIDE



Uni-Fit®
8000-13000 Btu
Up to 9.6 EER

Uni-Fit®
Electric Heat
COOLING
8000-11500 Btu
Up to 9.6 EER

ELECTRIC HEAT
3850-11200 Btu



COOL



COOL & HEAT



Select MODE, FAN SPEED, adjust TEMPERATURE and set the TIMER.

USC wall sleeve ships with weather panels and grille.

Sleeve is shown at right with standard painted steel inner panel, painted steel outer panel and standard grille



Inner weather panel.



USC sleeve.



Outer weather panel



Standard grille

NOTE: Chassis requires USC sleeve for new installations (sold and shipped separately)

UNI-FIT® FEATURES

Comfort & Convenience

- 6-way air flow control
- Remote control
- 24-hour timer
- 3-speed fan
- Auto restart
- Defrost control

Energy Management and Compliance

- Money Saver® setting saves money by conserving energy
- ENERGY STAR® qualified models
- R-410A refrigerant

Health and IAQ

- Washable antimicrobial filter
- Stale air exhaust

Durability & Quality

- Rotary compressors provide quiet, dependable performance
- Seacoast protection for corrosion resistance in harsh environments

Installation and Maintenance Features

- Universal fit trim ring
- Chassis designed to fit 24 1/2" to 27" sleeves
- USC sleeve fits standard 26" sleeve opening. See installation manual for exact dimensions.

Accessories

- USC sleeve ships with expanded aluminum grille
- Replacement grille ships with US/UE chassis for use in existing sleeves when a grille is needed

Madiso
Appliance Authority
800-570-3355



Trim ring

IMPORTANT: 1" gap on sides and 1/2" gap at top, which allows installation into varying sleeve sizes, can be covered by two-piece trim ring that fits over the chassis front. Trim ring comes standard with chassis.

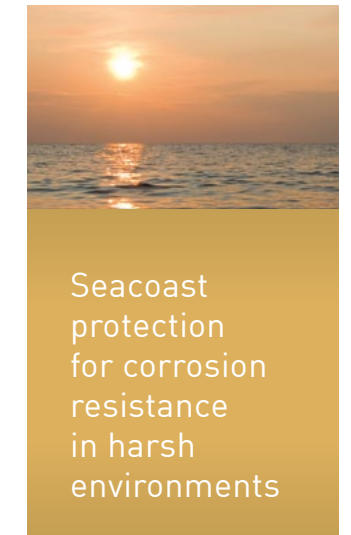

Seacoast protection for corrosion resistance in harsh environments

Uni-Fit® installs in many existing sleeves.

Sleeve Dimensions	Friedrich USC Sleeve	Amana	Carrier (51S Series)	Fedders/Emerson/Friedrich WSD	Emerson/Fedders	GE/Hot-point	Whirlpool	White-Westinghouse/Frigidaire/Carrier (52F Series)
Height (inches)	15 1/2	15 5/8	16 7/8	16 3/4	15 3/4	15 5/8	16 1/2	15 1/4
Width (inches)	25 7/8	26	25 3/4	27	26 3/4	26	25 7/8	25 1/2
Depth (inches)	16 3/4	16 7/8	18 5/8	16 3/4 or 19 3/4	15	16 7/8	17 1/8 or 23	16, 17 1/2 or 22

NOTE: Chassis requires USC sleeve for new installations (sold and shipped separately)



THRU-THE-WALL OPTIONAL ACCESSORIES

WallMaster® 27" Sleeve Exterior Grilles



WSD SLEEVE
Standard Grille
Premium, stamped galvanized steel grille with powder coat paint. Ships with sleeve. Galvanized steel inner and outer weather panels also ship with sleeve.



WSD SLEEVE
Optional Architectural Grille- AG
Premium brushed aluminum grille.

IMPORTANT:

Operating the air conditioner with incorrect rear grille or without Baffle Adapter Kit (on 19 3/4" deep sleeve) will recirculate discharge air and cause compressor overload to trip.

This will cause the unit to shut down temporarily and may lead to premature compressor failure.

CORRECT Vertical Louvers

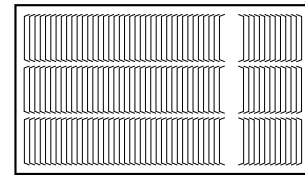

INCORRECT Horizontal Louvers

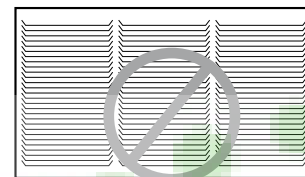

Installation Accessories (27" sleeve models only)

DK / Drain Kit
Installed at the back of the unit and allows for attachment to condensate disposal system, if necessary or desired.



IDK / Internal Drain Kit
New construction applications where a condensate drain system has been built into the wall interior.



BAK / Baffle Adapter Kit
Necessary when installing in a sleeve deeper than 16 3/4" deep, such as Fedders B sleeve (19 3/4" deep).



Uni-Fit® 26" Sleeve Exterior Grilles



USC Sleeve Standard Grille



Sleeve shown with Replacement Grille

STANDARD GRILLE - Ships with USC sleeve
Expanded aluminum grille designed for use with USC sleeve.

REPLACEMENT GRILLE - Ships with US/UE chassis
Black plastic for use on existing sleeves without any grille.

IMPORTANT:

When installing into an existing sleeve, consult Installation Section of your Installation/Operation Manual to determine whether or not the grille needs to be replaced and/or a baffle adapter should be used.

Sleeve/Chassis Dimensions

Model	Height	Width	Depth	Depth with Front	Minimum Extension Into Room	Minimum Extension Outside	Thru-the-wall Finished Hole		
							Height	Width	Max. Depth
WallMaster®									
WSD Sleeve	16 3/4"	27"	16 3/4"	23"	7 1/2"	9/16"	17 1/4"	27 1/4"	15 5/16"
Chassis	15 3/4"	26 1/2"	21"	22"	-	-	-	-	-
Uni-Fit®									
USC Sleeve	15 1/2"	25 7/8"	16 3/4"	20 1/2"	-	1/2"	15 3/4"	26 1/8"	16 1/4"
US Chassis	14 3/8"	24"	18 1/2"	20 1/8"	3 3/4"	-	-	-	-
UE Chassis	14 3/8"	24 5/8"	18"	19 5/8"	3 1/2"	-	-	-	-

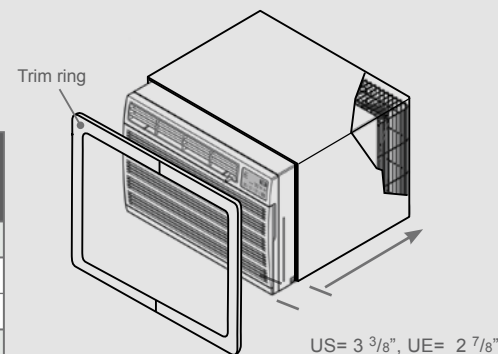

IMPORTANT:

US chassis w/front fully installed into USC sleeve extends into room 3 3/8". UE chassis w/front fully installed into USC sleeve extends into room 2 7/8". 1" gap on sides and 1/2" gap at top can be covered by two-piece trim ring that fits over the chassis front

THRU-THE-WALL SPECIFICATIONS

★ ENERGY STAR® models

Model	Cooling Btu	Heating Btu	Volts Rated	Cooling Amps	Cooling Watts	Heating Amps	Heating Watts	Energy Efficiency Ratio EER	Estimated Yearly Operating Cost	Moisture Removal Pints/HR	CFM	Sleeve	Net Weight Lbs.	Ship Weight Lbs.
WALLMASTER®														
Cool only														
★ WS08C10	7800	NA	115	7.1	788	NA	NA	9.9	†	1.2	250	WSD	93	97
★ WS10C10	9700	NA	115	10.0	1032	NA	NA	9.4	\$82	2.4	260	WSD	103	107
★ WS12C10C	11500	NA	115	11.5	1223	NA	NA	9.4	\$98	3.1	320	WSD	112	116
★ WS10C30	9500/9200	NA	230/208	4.5/4.7	989/958	NA	NA	9.6/9.6	\$79	1.5	300	WSD	101	105
★ WS12C30	11500/11200	NA	230/208	5.5/6.0	1223/1191	NA	NA	9.4/9.4	\$98	3.0	320	WSD	109	113
WS16C30	15600/15000	NA	230/208	8.3/8.9	1835/1765	NA	NA	8.5/8.5	\$144	4.2	290	WSD	119	123
Heat Pump														
★ WY09C33	9300/9000	7300/7300	230/208	4.4/4.7	989/957	3.8/4.0	839/793	9.4/9.4	\$79	2.1	250	WSD	103	107
WY12C33	12000/11800	9350/9200	230/208	6.1/6.4	1395/1372	4.8/5.1	1062/1010	8.6/8.6	\$111	2.6	275	WSD	111	115
Cool with Electric Heat														
WE10C33	9500/9200	11000/9100	230/208	4.5/4.7	989/957	16.0/14.7	3550/2950	9.6/9.6	\$79	1.5	300	WSD	121	125
WE12C33	11500/11200	11000/9100	230/208	5.5/6.0	1123/1191	16.0/14.7	3550/2950	9.4/9.4	\$98	3.0	320	WSD	107	111
WE16C33	15600/15000	11000/9100	230/208	8.3/8.9	1835/1765	16.0/14.7	3550/2950	8.5/8.5	\$140	4.2	290	WSD	116	120
UNI-FIT®														
Cool Only														
★ US08D10	8000	-	115	7.5	830	-	-	9.6	\$66	2.2	260	USC	73	79
★ US10D10	9800	-	115	9.6	1040	-	-	9.4	\$83	3.2	285	USC	78	84
★ US12D10	11500	-	115	11.2	1220	-	-	9.4	\$97	3.8	290	USC	80	87
★ US10D30	10000/9800	-	230/208	4.7/5.2	1060/1040	-	-	9.4/9.4	\$85	3.2	285	USC	78	84
★ US12D30	11500/11200	-	230/208	5.6/6.0	1220/1190	-	-	9.4/9.4	\$97	3.8	290	USC	80	87
US14D30A	13000/12600	-	230/208	7.0/7.5	1520/1480	-	-	8.5/8.5	\$121	4.0	310	USC	97	94
Cool with Electric Heat														
UE08D11	8000	3850	115	7.5	830	10.7	1230	9.6	\$66	2.2	260	USC	73	79
UE10D33	10000/9800	11200/9200	230/208	4.7/5.2	1060/1040	15.3/14.0	3500/2900	9.4/9.4	\$85	3.2	285	USC	78	84
UE12D33	11500/11200	11200/9200	230/208	5.6/6.0	1220/1190	15.3/14.0	3500/2900	9.4/9.4	\$97	3.8	290	USC	80	87

WallMaster Heat Pump heating information (shown in red) indicates heat pump heating performance. WallMaster Electric Heat heating information (shown in red) indicates electric heat strip performance. For WallMaster Heat Pump electric heating performance refer to corresponding WallMaster Electric Heat model.

WALLMASTER HEAT PUMP

HEATING PERFORMANCE: Change-over from heat pump operation to resistance operation on models indicated is automatic at a preset outside ambient temperature of approximately 35°F.

Calculate the heat loss of the space to be heated. As long as the heat loss does not exceed the resistance heating capacity rating of the unit, the heating performance will be satisfactory.

Note: all models will produce condensate. If condensate disposal is desired, an optional drain kit is available.

DEFROST CONTROL: Initiated at 30°F (outdoor coil temperature) and terminated at 43°F (outdoor coil temperature). During defrost, the compressor stops and the electric heat starts, then operates with the fan to maintain indoor comfort. Below 43°F, the unit remains in electric heat mode.

DEFROST DRAIN: Drain automatically opens at approximately 50°F to prevent condensate from freezing inside drain pan.

Plug Face/ Circuit Rating

WallMaster® Model Number	Uni-Fit® Model Number	Circuit Rating Breaker or T-D Fuse	Plug Face (NEMA#)	Power Cord Length (ft.)	Wall Outlet Appearance
WS08C10, WS10C10, WS12C10C	US08D10, UE08D11 US10D10, US12D10	125V - 15A	5 - 15P	6	
WS10C30, WS12C30, WS16C30	US10D30, US12D30, US14D30	250V - 15A	6 - 15P	4	
WE10C33, WE13C33, WE16C33, WY09C33, WY12C33	UE10D33, UE12D33	250V - 20A	6 - 20P	4	

Power cords are located on front left of WallMaster models and on front right of Uni-Fit models.

Model	Carton Dimensions INCHES		
	Height	Width	Depth
WallMaster®			
WSD Sleeve	18"	27 1/4"	18"
Chassis	15 3/4"	26 1/2"	21"
Uni-Fit®			
USC Sleeve	17 7/8"	28"	19 1/4"
US Chassis	17 1/4"	27"	22 1/4"
UE Chassis	17"	27 1/4"	22"

Due to continuing research in new energy-saving technology, specifications are subject to change without notice. As an ENERGY STAR® partner, Friedrich Air Conditioning Co. has determined that the selected ENERGY STAR® models meet the ENERGY STAR® guidelines for energy efficiency.

Estimated yearly operating cost based on a 2007 national average electricity cost of 10.65 cents per kWh. † The estimated yearly operating cost of this model was not available at the time the range was published.



FASTER COOLING & HIGHER EFFICIENCY

With dual hose design

Portable unit moves easily from room-to-room to provide fast cooling and heating comfort.



NOTE: Unit not shown installed. Vent hoses must vent outdoors.

DUAL-HOSE DESIGN

FOR UP TO 40% FASTER COOLING OR HEATING AND INCREASED EFFICIENCY

Self-evaporative condensate system, so there's no bucket to empty.

Removes up to 72 pts./day when used as a dehumidifier.

AIR CONDITIONER

3-in-1 system: Air conditioner, dehumidifier and fan.

Heat pump operation is more efficient than other portables that rely on resistance heat.

HEAT PUMP

4-in-1 system: Air conditioner, heater, dehumidifier and fan.



COOL



COOL & HEAT



Aj Madison

Your Appliance Authority™

800-570-3355

ZoneAire®
Air Conditioners
COOLING
9300 and 11600 Btu
Up to 9.4 EER

Heat pump
COOLING
13500 Btu
HEATING
10700 Btu
9.5 EER

PORTABLE AIR CONDITIONERS/HEAT PUMP

Comfort & Convenience

HEAT PUMP

- 4-IN-1 SYSTEM: Air conditioner, heater, dehumidifier and fan
- Dual hoses for closed loop cooling and exhaust functions for up to 40% faster, more efficient cooling
- Built-in drain pump to remove condensate in heating mode (drain hose included)
- Self-evaporative condensate system means no bucket to empty
- Condensate overflow protection- the unit will automatically shut off if tank should become full. The unit can be drained through the water outlet drain
- 24-hour timer
- 3 fan speeds
- Washable, antimicrobial air filter
- Auto restart after power outage
- Stores easily in most closets

AIR CONDITIONER

- 3-IN-1 SYSTEM: Air conditioner, dehumidifier and fan
- Dual hoses for closed loop cooling and exhaust functions for up to 40% faster, more efficient cooling
- Self-evaporative condensate system means no bucket to empty
- Condensate overflow protection- the unit will automatically shut off if tank should become full. The unit can be drained through the water outlet drain
- 24-hour timer
- 3 fan speeds
- Washable, antimicrobial air filter
- Auto restart after power outage
- Stores easily in most closets



Use remote to select MODE, FAN SPEED, adjust TEMPERATURE and set the TIMER.

Superior dual-hose design

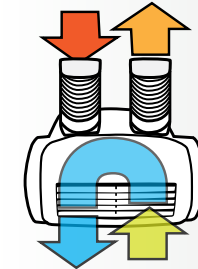

DUAL HOSE

Only indoor air is conditioned and returned into the room. Indoor air is not vented outside and wasted. The room is cooled up to 40% faster with greater energy efficiency.

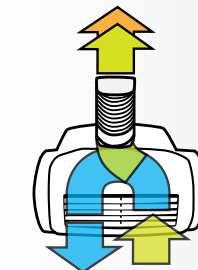

SINGLE HOSE

Relies on air 'leakage' around doors and windows to make up for air volume lost as indoor air is exhausted outside. Inefficient-both indoor air and removed heat are exhausted.



Be ready for cooling emergencies

INSTALLS QUICKLY AND EASILY WITH THE INCLUDED WINDOW INSTALLATION KIT.

NOTE: Air conditioners will provide cooling at outdoor temperatures down to 41° F and heat pumps will provide heating at outdoor temperatures down to 14° F with single hose installation.



RECYCLABLE PACKAGING



R-401A OZONE FRIENDLY REFRIGERANT

FEATURES/SPECIFICATIONS/INSTALLATION

Ideal Applications

- Supplemental or emergency cooling or heating anywhere
- Temporary cooling in computer rooms
- Guard buildings
- Construction trailers/RVs
- Workshops and garages
- Home offices
- Dorm rooms
- Bedrooms, attics and basements
- Sunrooms/enclosed patios

Installation Features

- Plugs into standard 115 volt outlet
- Easy-roll casters for portability
- All installation accessories included
- Window kit fits both vertical and horizontal standard and some casement slider windows
- 6 ft. long power cord

Installation Kit

INSTALLATION KIT- Dual intake and exhaust hoses. Flexible, heavy duty intake/exhaust hoses extend from 24" to 60". The hoses can be vented through a window or through a wall opening to the outside.

WINDOW SLIDER KIT (Included)



Fits HORIZONTAL or VERTICAL WINDOWS
WINDOW OPENING:

Minimum: 26"* Maximum: 46"

* Window slider kit can be trimmed to fit a smaller opening.

Model		P09B	P12B	PH14B
PERFORMANCE				
Cooling Capacity	Btu	9300	11600	13500
Heating Capacity	Btu	—	—	10700
Energy Efficiency Rating	EER	9.4	8.8	9.5
Coefficient of Performance	COP	—	—	2.8
Air Movement	CFM	212	235	250
Moisture Removal	Pts/hr.	5.0	6.0	6.0
SPECIFICATIONS				
Refrigerant Type		R-410A		
Power Supply	Volts	115		
Rated Current	Cooling Amps	10.8	11.5	10.8
	Heating Amps	—	—	10.8
Watts		989	1318	1421/1120
Dimensions (Inches)	W x H x D	19 1/2 x 33 1/2 x 15 1/2		
Weight (Net/Shipping)	Lbs.	71/89	72/90	78/95
Carton Dimensions (Inches)	W x H x D	20 7/8 x 43 1/8 x 16 3/4		

Model	Circuit Rating Breaker or T-D Fuse	Plug Face (NEMA#)	Wall Outlet Appearance	Power cord length
P09B, P12B, PH14B	125V - 15A	5 - 15P		6 ft.

Due to continuing research in new energy-saving technology, specifications are subject to change without notice.

NOTE: Air conditioners will provide cooling at outdoor temperatures down to 41° F and heat pumps will provide heating at outdoor temperatures down to 14° F with single hose installation.



HAZARDOUS LOCATION ROOM AIR CONDITIONERS

UL LISTED FOR CLASS 1, DIVISION 2, GROUPS A, B, C AND D HAZARDOUS LOCATIONS.

IEC CERTIFIED FOR CLASS 1, ZONE 2, GROUPS IIA, IIB AND IIC HAZARDOUS LOCATIONS.



Hazardgard®
60 Hertz
North America
14500 & 20000 Btu
Up to 9.7 EER

Hazardgard®
50 Hertz
International
19500 Btu
9.0 EER



Hazardgard® is specifically designed to cool living quarters, storage areas and other enclosures situated in hazardous locations, where specific volatile flammable liquids or gases are handled or used within enclosed containers or systems.

T4 temperature classification, unit surface temperatures will not rise above 135° C/275° F. Operates at low ambient conditions without freezing at outdoor ambient temperatures as low as 7° C/45° F. Tolerates higher outdoor temperatures up to 55° C/130° F.

Equipment is certified in accordance with ISA 12.12.01 and NFPA 70-10 (National Electric Code)

ARTICLE 501

Class I, Div. 2, Group A and Group B
Class I, Div. 2, Group B

Class I, Div. 2, Group C

Class I, Div. 2, Group D

ARTICLE 505

Class I, Zone 2, Group IIC
Class I, Zone 2, Group IIB plus hydrogen, or "+H2"

Class I, Zone 2, Group IIB

Class I, Zone 2, Group IIA

For more than 30 years, Hazardgard has endured some of the toughest and most unforgiving operating conditions imaginable. Time-tested in the field where it counts, Hazardgard is trusted by professionals who have to get the job done.

Robust engineering with design details like 33% thicker fins extend the life of the coil.

Diamonblue™ advanced corrosion protection on the outdoor coil provides added endurance and protection in coastal or corrosive environments.

Totally enclosed, heavy-duty motors have a hermetically sealed overload for arc-free operation.

FEATURES

- Permanent split capacitor
- Hermetically sealed refrigeration system
- Environmentally sealed on/off switch and gold plated contacts in thermostat for corrosion resistance.
- Solid-state control relays for compressor and fan operation.
- Hot gas bypass allows the air conditioner to operate at low ambient conditions without freezing at outdoor ambient temperatures as low as 45° F.
- Hermetically sealed reciprocating compressor is cooled during the refrigeration cycle, which allows the unit to tolerate higher outdoor temperatures up to 130° F.
- Larger, commercial grade, enclosed fan motor with hermetically sealed overload for arc-free operation. Totally enclosed to assure efficient operation under adverse electrical conditions.
- Unit utilizes direct-wired, 15-amp circuit with time-delay fuse that will tolerate current surge without tripping the breaker.
- 20-gauge steel is used in order to create a more robust air conditioner cabinet that will withstand years of hard use.
- Diamonblue advanced corrosion protection provides added endurance and protection in coastal or corrosive environments.
- T4 temperature classification

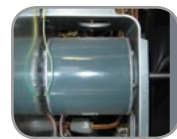

APPLICATIONS

Built to perform in the harshest environments

- Offshore oil rigs, on-shore oil company offices and refineries
- Petrochemical sites and propane fill-up stations
- Paint and varnish storage or processing plants
- Grain alcohol processors or storage sites
- Plant areas using strong solvents or chemicals
- Munitions plants or armories
- PVC or plastics plants and processing points
- Recycling plants
- Furniture refinishing/stripping workshops
- Fertilizer plants
- Office complexes where methane is a by-product
- Hazardous materials storage
- Container labs
- For analyzer houses/shelters

Built tough

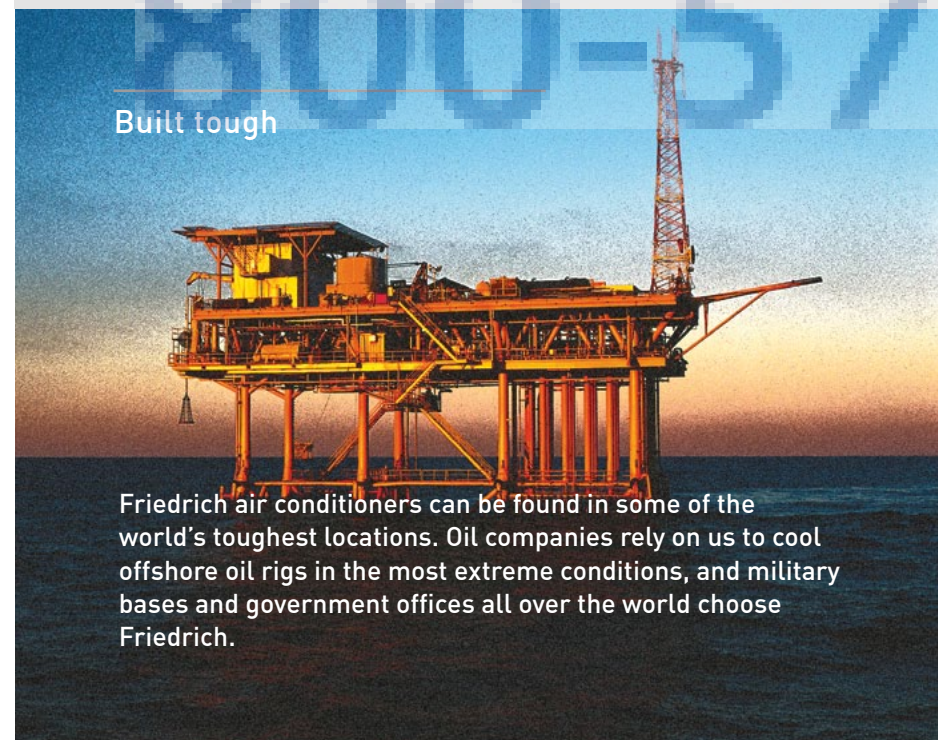

Friedrich air conditioners can be found in some of the world's toughest locations. Oil companies rely on us to cool offshore oil rigs in the most extreme conditions, and military bases and government offices all over the world choose Friedrich.

SPECIFICATIONS

Specifications

Model	Electrical Characteristics				Energy Efficiency Ratio EER	Moisture Removal Pints/ HR	Air Direction Controls	Refrigerant
	Cooling Capacity Btu	Volts Rated	Cooling Amps	Cooling Watts				
60 HERTZ - NORTH AMERICA								
SH15M30A	14500/14000	230/208	6.9/7.5	1495/1443	9.7/9.7	6.0	8-way	R-410A
SH20M30A	20000/19000	230/208	8.7/9.6	2125/2021	9.4/9.4	4.0	8-way	R-410A
50 HERTZ - INTERNATIONAL								
SH20M50A	19500/19100	240/220	9.8/10.3	2167/2156	9.0/9.0	5.6/5.5	8-way	R-410A

Installation Information

Model	Dimensions INCHES						Window Width INCHES		In-Wall Installation Finished Hole INCHES			Circuit Rating Breaker or T - D Fuse Volts - Amps	Weight Lbs.	
	Height	Width	Depth with Front A	Depth J Box to Louvers B	Minimum Extension Into Room	Minimum Extension Outside	Min.	Max.	Height	Width	Max. Depth C		Net	Shipping
SH15M30A	15 15/16"	25 15/16"	27 3/8"	6"	3 1/16"	16 15/16"	27 7/8"	42"	16 3/16"	26 3/16"	6"	250V - 15A	140	167
SH20M30A	17 15/16"	25 15/16"	27 3/8"	6"	3 1/16"	16 15/16"	27 7/8"	42"	18 3/16"	26 3/16"	6"	250V - 15A	166	170
SH20M50A	17 15/16"	25 15/16"	27 3/8"	6"	3 1/16"	16 15/16"	27 7/8"	42"	18 3/16"	26 3/16"	6"	250V - 15A	171	175

Due to continuing engineering research and technology, specifications are subject to change without notice. Manufactured under U.S. Design Patent DES 368, 306 decorative front; Utility Patent 5, 622, 058. MAXIMUM outdoor ambient operating temperature is 130°F. MAXIMUM TEMPERATURE RATING FOR CLASS I, DIVISION 2, GROUPS A,B,C,D.

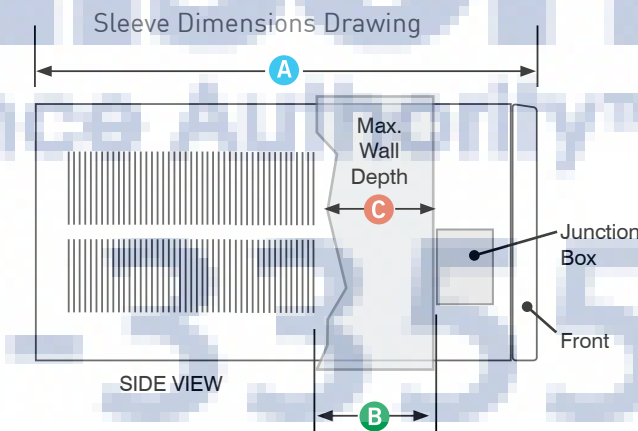

NOTE: Hazardgard unit must be hard-wired.



DIAMONBLUE™
Advanced Corrosion Protection

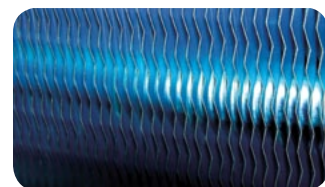



Friedrich is a partner in the ENERGY STAR® program which promotes the conservation of energy and the protection of the environment through the purchase of high efficiency appliances.



FRIEDRICH

Friedrich Air Conditioning Co. | 10001 Reunion Place, Suite 500 | San Antonio, TX 78216 | 800.541.6645 | www.friedrich.com