

quick start guide

English



RF31FM**

1. Safety Information









Safety information

- Before using your new Samsung French Door Refrigerator, please read this manual thoroughly to ensure that you know how to operate the features and functions that your new appliance offers safely and efficiently.
- This appliance is not intended for use by persons (including children) with reduced physical, sensory, or mental capabilities, or those who lack experience and knowledge, unless they have been given supervision or instruction concerning the use of the appliance by a person responsible for their safety.
- Because the following instructions cover various models, the characteristics of your refrigerator may differ slightly from the refrigerator described in this manual. If you have any question, contact us at 1-800-SAMSUNG or find help and information online at www.samsung.com.

Important safety symbols and precautions:

| | |
|--|--|
|  WARNING | Hazards or unsafe practices that may result in severe personal injury or death. |
|  CAUTION | Hazards or unsafe practices that may result in minor personal injury or property damage. |

OTHER SYMBOLS USED

| | |
|---|--|
|  | Do NOT attempt. |
|  | Do NOT disassemble. |
|  | Do NOT touch. |
|  | Follow directions carefully. |
|  | Unplug the power plug from the wall socket. |
|  | Make sure the machine is grounded to prevent electric shock. |
|  | Call the contact center for help. |
|  | Note. |

These warning symbols are here to prevent injury to you and others.

Please follow them carefully.

After reading this section, keep it in a safe place for future reference.

CRITICAL INSTALLATION WARNINGS



- Do not install the refrigerator in a damp place or place where it may come in contact with water.
 - Deteriorated insulation on electrical parts may cause an electric shock or fire.
 - Do not place this refrigerator in direct sunlight or expose it to the heat from stoves, room heaters, or other appliances.
 - Do not plug several appliances into the same multiple power strip. The refrigerator should always be plugged into its own individual electrical outlet which has a voltage rating that matches the voltage listed on the refrigerator's rating plate.
 - This provides the best performance and also prevents overloading house wiring circuits, which could cause a fire hazard from overheated wires.
 - If the wall socket is loose, do not insert the power plug.
 - There is a risk of electric shock or fire.
 - Do not use a cord that shows cracks or abrasion damage along its length or at either end.
 - Do not bend the power cord excessively or place heavy articles on it.
 - Do not twist or tie the power cord.
 - Do not hook the power cord over a metal object, place a heavy object on the power cord, insert the power cord between objects, or push the power cord into the space behind the appliance.
 - When moving the refrigerator, be careful not to roll over or damage the power cord
 - This may result in an electric shock or fire.
 - Never unplug your refrigerator by pulling on the power cord. Always grip the plug firmly and pull straight out from the outlet.
 - Damage to the cord may cause a short-circuit, fire, and/or electric shock.
 - Do not use aerosols near the refrigerator.
 - Using aerosols near the refrigerator may cause an explosion or fire.
 - Do not install this appliance near a heater, inflammable material.
 - Do not install this appliance in a humid, oily or dusty location, in a location exposed to direct sunlight and water (rain drops).
 - Do not install this appliance in a location where gas may leak.
 - This may result in an electric shock or fire.
-



- This refrigerator must be properly located and installed in accordance with the instructions in this manual before you use it.
 - Connect the power plug in the proper position with the cord hanging down.
 - If you connect the power plug upside down, the wire can get cut off and cause a fire or electric shock.
 - When moving the refrigerator, be careful not to roll over or damage the power cord.
 - This constitutes a fire hazard.
 - Make sure that the power plug is not squashed or damaged by the back of the refrigerator.
 - Keep the packing materials out of reach of children.
 - There is a risk of death from suffocation if a child puts the packing materials on his or her head.
 - The appliance must be positioned so that the plug is accessible after installation.
 - Failing to do so may result in an electric shock or fire due to electric leakage.
 - You need to remove all the protective plastic film before you initially plug the product in.
-



- The refrigerator must be safely grounded.
 - Always make sure that you have grounded the refrigerator before attempting to investigate or repair any part of the appliance. Power leakages can cause severe electric shock.
 - Never use gas pipes, telephone lines, or other potential lightning attractors as an electrical ground.
 - Improper use of the grounding plug can result in a risk of electric shock. If it is necessary to use an extension cord, use only a 3-wire extension cord that has a 3-blade grounding plug and a 3-slot receptacle that will accept the plug on the appliance. The marked rating of the extension cord should be AC115-120 V, 10 A, or more. If a grounding adapter is used, make sure the receptacle box is fully grounded.
 - Plug the power plug into the wall socket firmly. Do not use a damaged power plug, damaged power cord or loose wall socket.
 - This may result in an electric shock or fire.
 - The modification of the unit by the user can cause safety problems also, if it have some, the repair cost will be charged.
-



- If the power cord is damaged, have it replaced immediately by the manufacturer or its service agent.

INSTALLATION CAUTIONS



- Allow sufficient space around the refrigerator and install it on a flat surface.
- If your refrigerator is not level, the internal cooling system may not work correctly.
- Keep the ventilation space in the appliance enclosure or mounting structure clear of obstruction.
- Allow the appliance to stand for 2 hours after installation.
- The installation or any service of this appliance is recommended by a qualified technician or service company.
- Failing to do so may result in an electric shock, fire, explosion, problems with the product, or injury.

CRITICAL USAGE WARNINGS



- Do not insert the power plug with wet hands.
- Do not store articles on the top of the appliance.
- When you open or close the door, the articles may fall and cause personal injury and/or material damage.
- Do not insert hands, feet or metal objects (such as chopsticks, etc.) into the bottom or the back of the refrigerator.
- This may result in an electric shock or injury.
- Any sharp edges may cause a personal injury.
- Do not put a container filled with water on the refrigerator.
- If spilled, there is a risk of fire or electric shock.
- Children should be supervised to ensure that they do not play with the appliance.
- Keep fingers out of "pinch point" areas; clearances between the doors and cabinet are necessarily small. Be careful when you open the doors when children are in the area.
- Do not let children hang on the door. A serious injury may occur.
- Do not let children go inside the refrigerator. Children could become trapped.
- Do not insert your hands into the bottom area under the appliance.
- Any sharp edges may cause personal injury.
- Do not let children step on a drawer cover.
- The drawer may break and cause them to slip.



- Do not overfill the refrigerator with food.
 - When you open the door, an item may fall out and cause personal injury or material damage.
 - Do not touch the inside walls of the freezer or products stored in the freezer with wet hands.
 - This may cause frostbite.
 - Never put fingers or other objects into the water dispenser hole, ice chute, or ice maker bucket.
 - It may cause personal injury or material damage.
 - Do not use or place any substances sensitive to temperature such as inflammable sprays, inflammable objects, dry ice, medicine, or chemicals near or inside of the refrigerator.
 - Do not keep volatile or inflammable objects or substances (benzene, thinner, propane gas, alcohol, ether, LP gas and other such products etc.) in the refrigerator.
 - This refrigerator is for storing food only.
 - This may result in fire or explosion.
 - Do not store pharmaceutical products, scientific materials, or temperature sensitive products in the refrigerator.
 - Products that require strict temperature controls must not be stored in the refrigerator.
 - Do not place or use an electrical appliance inside the refrigerator, unless it is of a type recommended by the manufacturer.
 - Do not stand on top of the appliance or place objects (such as laundry, lighted candles, lighted cigarettes, dishes, chemicals, metal objects, etc.) on the appliance. This may result in an electric shock, fire, problems with the product, or injury. Do not put a container filled with water on the appliance.
 - If spilled, there is a risk of fire or electric shock.
 - Do not use mechanical devices or any other means to accelerate the defrosting process, other than those recommended by the manufacturer.
 - Do not damage the refrigerant circuit.
 - Do not spray volatile material such as insecticide onto the surface of the appliance.
 - As well as being harmful to humans, it may also result in an electric shock, fire or problems with the product.
 - Never stare directly at the UV LED lamp for long periods of time.
 - This may result in eye strain due to the ultraviolet rays.
-



- Do not attempt to repair, disassemble, or modify the appliance yourself.
 - Do not use any fuse (such as copper, steel wire, etc.) other than the standard fuse.
 - When repairing or reinstalling the appliance is required, contact your nearest service center.
 - Failing to do so may result in an electric shock, fire, problems with the product, or injury.
 - When the interior or exterior LED lamp has gone out, please contact your service agent.
-



- Children should be supervised to ensure that they do not play with the appliance.
 - Keep fingers out of "pinch point" areas : clearances between the doors and cabinet are necessarily small. Be careful when you open the doors when children are in the area. Do not let children hang on the door. If not, a serious injury may occur. Risk of children entrapment. Do not let children enter inside the refrigerator.
 - Bottles should be stored tightly together so that they do not fall out.
 - This product is intended only for the storage of food in a domestic environment.
 - If a gas leak is detected, avoid any naked flames or potential sources of ignition and air the room in which the appliance is standing for several minutes.
 - Do not touch the appliance or power cord.
 - Do not use a ventilating fan.
 - A spark may result in explosion or fire.
 - Use only the LED Lamps provided by the manufacturer or its service agents.
-



- If the refrigerator emits a burning smell or smoke, pull the power plug immediately and contact your Samsung Electronics service center.
- If you experience difficulty changing a non-LED light, contact a Samsung service energy.
- If the product is equipped with LED Lamps, do not disassemble the Lamp Covers and LED Lamps yourself.



- Please contact your service agents.
- If dust or water enters the refrigerator, pull out the power plug and contact your Samsung Electronics service center.
- Otherwise there is a risk of fire

USAGE CAUTIONS



- Do not re-freeze frozen foods that have thawed completely. Do not place carbonated or fizzy drinks in the freezer compartment. Do not put bottles or glass containers in the freezer.
 - When the contents freeze, the glass may break and cause personal injury.
 - Use only the ice maker provided with the refrigerator. The water supply to this refrigerator must only be installed/connected by a suitably qualified person and connected to a potable water supply only. In order to operate the ice maker properly, water pressure of 20 ~ 125psi is required. If you have a long vacation or business trip and won't use water or ice dispensers, close the water valve.
 - Otherwise, water leakage may occur.
 - Wipe excess moisture from the inside and leave the doors open.
 - Otherwise, odor and mold may develop.
-



- Service Warranty and Modification.
 - Any changes or modifications performed by a 3rd party on this finished appliance are not covered under Samsung warranty service, nor is Samsung responsible for safety issues that result from 3rd party modifications.
 - Do not block the air holes.
 - If the air holes are blocked, especially with a plastic bag, the refrigerator can be over cooled. If this cooling period lasts too long, the water filter may break and cause water leakage.
 - If the refrigerator is disconnected from the power supply, you should wait for at least five minutes before plugging it back in.
 - If you have a long vacation planned or do not intend to use the refrigerator for a long period of time, empty the refrigerator, pull out the power plug, wipe excess moisture from the inside walls, and leave the doors open to prevent odors and mold.
 - Letting the refrigerator run long periods of time without using it can cause the insulation to deteriorate and may cause a fire.
 - To get the best performance from the product:
 - Do not place food too close to the vents at the rear of the appliance as it can obstruct free air circulation in the refrigerator compartment.
 - Wrap food up properly or place it in airtight containers before putting it into the refrigerator.
 - Do not place glass or bottles or carbonated beverages into the freezer. The container may freeze and break, and this may result in injury.
 - Please observe maximum storage times and expiry dates of frozen goods.
 - There is no need to disconnect the refrigerator from the power supply if you will be away for less than three weeks. But, Remove all the food if you are going away for the three weeks or more. Unplug the refrigerator and clean it, rinse and dry.
 - Fill the water tank, ice tray and water cubes only with potable water (mineral water or purified water).
 - Do not fill the tank with tea, juice or sports drink, this may damage the refrigerator.
-



- If the product is flooded, make sure to contact your nearest service center.
- There is a risk of electric shock or fire.

CLEANING CAUTIONS



- Do not directly spray water on the inside or outside the refrigerator.
 - There is a risk of fire or electric shock.
 - Do not use a hair dryer to dry the inside of the refrigerator. Do not place a lighted candle in the refrigerator to remove bad odors.
 - This may result in an electric shock or fire.
-



- Remove any foreign matter or dust from the power plug pins. Do not use a wet or damp cloth when cleaning the plug.
 - Otherwise, there is a risk of fire or electric shock.
-



- Before cleaning or performing maintenance, unplug the appliance from the wall socket.
 - Failing to do so may result in an electric shock or fire.

State of California Proposition 65 Warnings:

The California Safe Drinking Water and Toxic Enforcement Act requires the Governor of California to publish a list of substances known to the State of California to cause cancer, birth defects, or other reproductive harm, and requires businesses to warn of potential exposure to such substances.

This product contains a chemical known to the State of California to cause cancer, birth defects, or other reproductive harm. This appliance can cause low-level exposure to some of the substances listed, including benzene, formaldehyde, and carbon monoxide.

CRITICAL DISPOSAL WARNINGS



- DANGER : Risk of child entrapment, Before you throw away your old refrigerator or freezer
 - Take off the doors.
 - Leave the shelves in place so that children may not easily climb inside.
- Please dispose of the packaging material from this product in an environmentally friendly manner.
- Ensure that none of the pipes on the back of the appliance are damaged prior to disposal. The pipes shall be broken in the open space.
- R-600a or R-134a is used as a refrigerant. Check the compressor label on the rear of the appliance or the rating label inside the fridge to see which refrigerant is used for your refrigerator. If this product contains flammable gas (Refrigerant R-600a), contact your local authority in regard to safe disposal of this product.
- When disposing of this refrigerator, remove the door/door seals and door latch so that small children or animals cannot become trapped inside. Children should be supervised to ensure that they do not play with the appliance. If trapped inside, the child may become injury and suffocate to death.
- Cyclopentane is used in the insulation. The gases in the insulation material require a special disposal procedure. Please contact your local authorities in regard to the environmentally safe disposal of this product.
- Keep all packaging materials well out of the reach of children, as packaging materials can be dangerous to children.
 - If a child places a bag over its head, it may result in suffocation.

ADDITIONAL TIPS FOR PROPER USAGE

- In the event of a power failure, call the local office of your Electricity Company and ask how long it is going to last.
- Most power failures that are corrected in an hour or two will not affect your refrigerator temperatures. However, you should minimize the number of door openings while the power is off.
- But Should the power failure last more than 24hours, remove all frozen food.
- If the key is provided with refrigerator, the keys should be kept out of the reach of children and not be in the vicinity of the appliance.
- The appliance might not operate consistently (possibility of defrosting of co tents or temperature becoming too warm in the frozen food compartment) when sited for an extended period of time below the cold end of the range of temperatures for which the refrigerating appliance is designed.
- Do not store food which goes bad easily at low temperature, such as bananas, melons.
- Your appliance is frost free, which means there is no need to manually defrost your appliance, as this will be carried out automatically.
- Temperature rise during defrosting can comply with ISO requirements. But If you want to prevent an undue rise in the temperature of the frozen food while defrosting the appliance, please wrap the frozen food up in several layers of newspaper.
- Any increase in temperature of frozen food during defrosting can shorten its storage life.
- Do not re-freeze frozen foods that have thawed completely.

Saving Energy Tips

- Install the appliance in a cool, dry room with adequate ventilation. Ensure that it is not exposed to direct sunlight and never put it near a direct source of heat (radiator, for example).
- Never block any vents or grilles on the appliance.
- Allow warm food to cool down before placing it in the appliance.
- Put frozen food in the refrigerator to thaw. You can then use the low temperatures of the frozen products to cool food in the refrigerator.
- Do not keep the door of the appliance open for too long when putting food in or taking food out. The shorter time for which the door is open, the less ice will form in the freezer.
- Allow clearance to the right, left, back and top when installing. This will help reduce power consumption and keep your energy bills lower.

2. The Installation Space

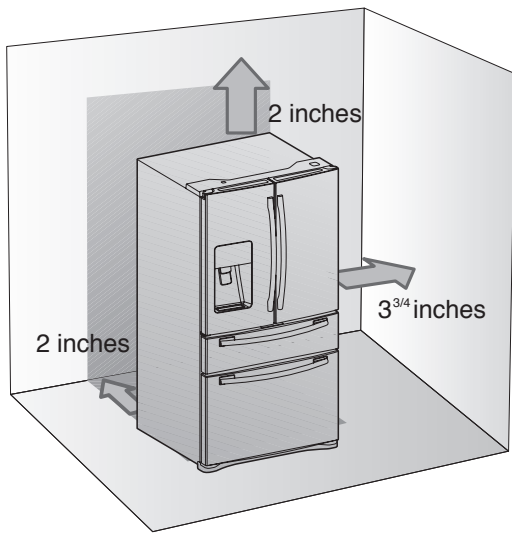

Selecting the best location for the Refrigerator

- A location with easy access to a water supply.
- A location without direct exposure to sunlight.
- A location with a level floor.
- A location with enough space for the refrigerator doors to open easily.
- A location that allows sufficient space to the right, left, back and top for air circulation.
- A location that allows you to move the refrigerator easily if it needs maintenance or service.

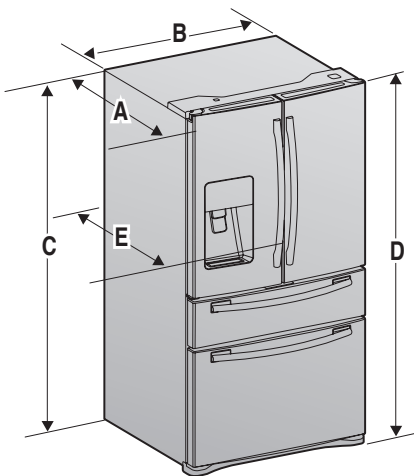

| | |
|--------------------|------------------|
| Model | RF31FM** |
| Depth "A" | 35 1/2" (901mm) |
| Width "B" | 35 6/8" (908mm) |
| Height "C" | 68 7/8" (1749mm) |
| Overall Height "D" | 70" (1777mm) |
| Depth "E" | 37 7/8" (963mm) |



- Allow clearance to the right, left, back and top when installing. This will help reduce power consumption and keep your energy bills lower.
- Do not install the refrigerator where the temperature will go below 50°F (10°C).
- Do not locate the refrigerator where it may become wet

FLOORING

For proper installation, you must place this refrigerator on a level, hard surface that is the same height as the rest of the floor. This surface should be strong enough to support a fully loaded refrigerator, or approximately 359lbs (165kg).

To protect the finish of the flooring, cut a large section of the cardboard carton and place it under the refrigerator where you are working. When moving the refrigerator, you need to pull and push it straight forwards or back. Do not wiggle it from side to side.

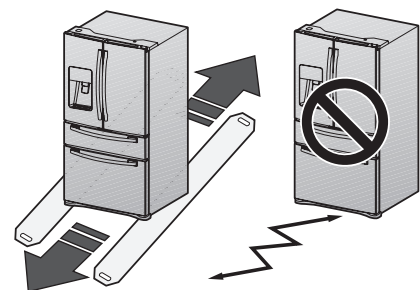

3. Names and basic functions

PARTS AND FEATURES

Use this page to become more familiar with the parts and features of the Refrigerator.

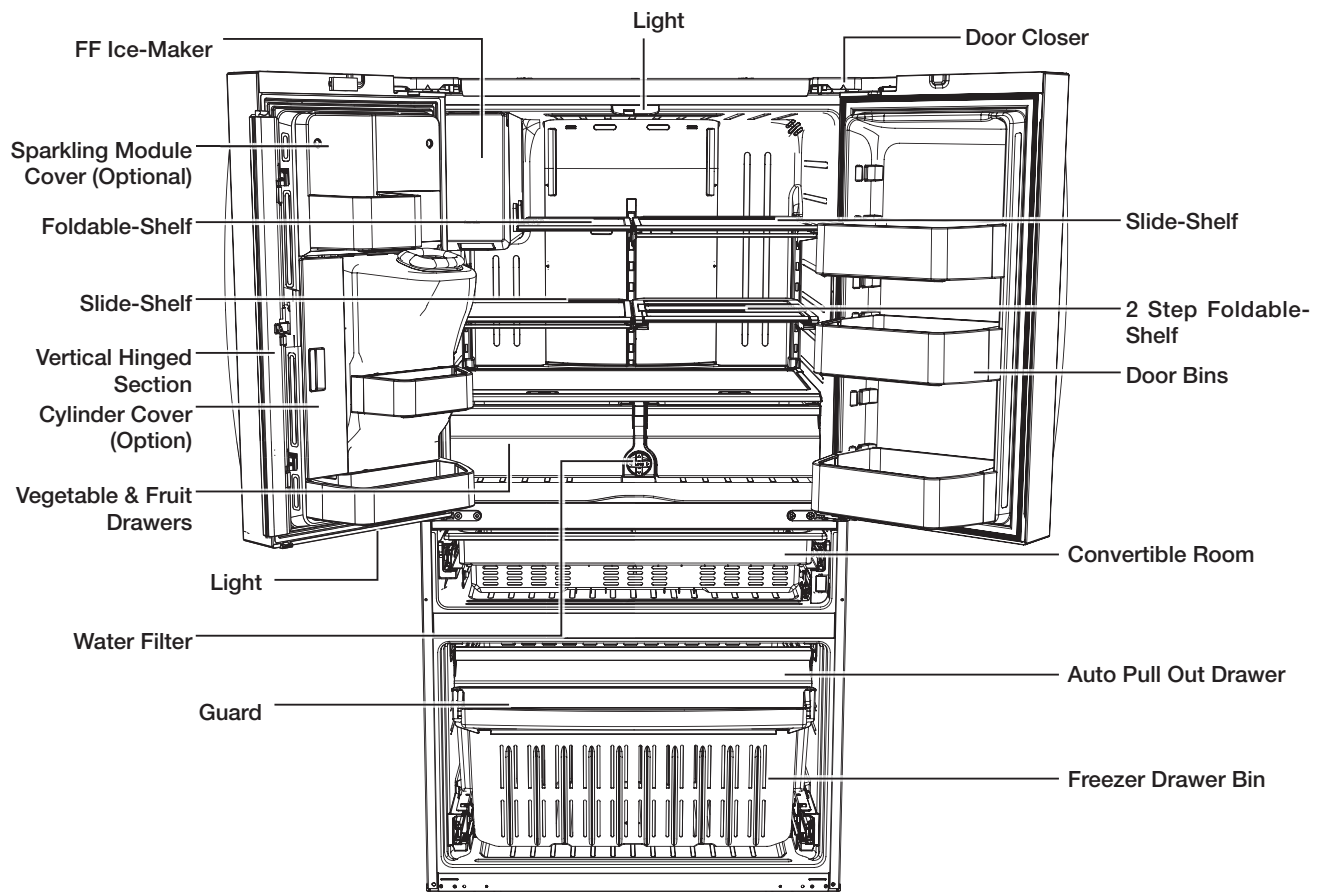

When closing the door, make sure the Vertical Hinged Section is in the correct position to avoid scratching the other door.

If the Vertical Hinged Section is reversed, put it back to the right position and close the door.

Moisture may appear at times on the Vertical Hinged Section.

The door handle may become loose over time. If this happens, tighten the bolts found on the inside of the door.

If you close one door with a lot of force, the other door may open.



When the door opens, the interlock switch automatically turns off the auger motor in the ice maker for safety reasons.



When the interior or exterior LED lamp has gone out, please contact your service agents.



4. Operating your Refrigerator

USING THE CONTROL PANEL

RF31FMES**

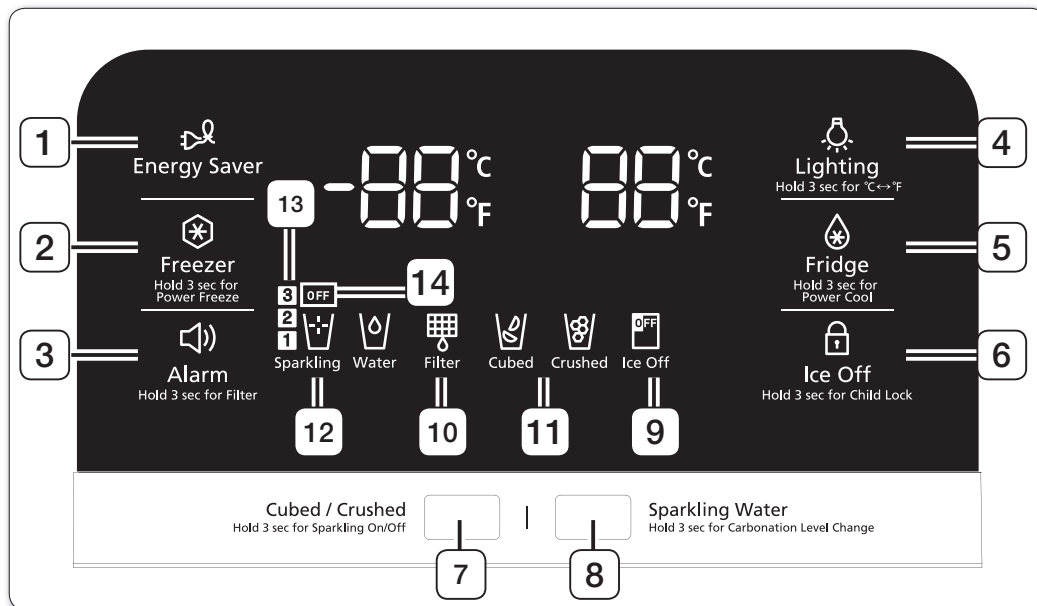
(For Sparkling model Only)







| | |
|--|--|
| <p>(1) Energy Saver</p>  | <p>Touching this button turns Energy Saver mode on and off. When you turn Energy Saver on, the Energy Saver icon lights. Turn Energy Saver off and the icon goes off. The Energy Saver function's factory setting is "ON". If condensation or water drops appear on the doors, turn the Energy Saver mode off.</p> |
| <p>(2) Freezer (Hold 3 sec for Power Freezer)</p>  | <p>The Freezer button serves two purposes:</p> <ul style="list-style-type: none"> - To set the Freezer to your desired temperature. - To turn the power freezer function on and off. <p>1) To set the Freezer temperature Touch the Freezer button to set the Freezer to your desired temperature. You can set the temperature between 5 °F (-15 °C) and -8 °F(-23 °C).</p> <p>2) Power Freezer function Touch and hold this button for 3 seconds to decrease the time needed to freeze products in the Freezer. It can be helpful if you need to quickly freeze easily spoiled items or if the temperature in the freezer has warmed dramatically (For example, if the door was left open).</p> |

| | |
|---|--|
| <p>(3) Alarm (Hold 3 sec for Filter Reset</p> | <p>The Alarm button serves two purposes:</p> <ul style="list-style-type: none"> - To turn the door open alarm on and off - To reset the water filter life indicator. <p>1) Door Alarm Function If the door alarm is set to On, an alarm beeps if any refrigerator door is left open for more than three minutes. The beeping stops when you close the door. The door alarm function is pre-set to On in the factory. You can turn it off by pressing and then releasing the Alarm button. You can turn it back on in the same fashion. The icon lights up when the function is on. When the Door Alarm function is on and there is an alarm sound which is triggered by the door opening, the Door Alarm Icon will blink together with the alarm sound.</p> <p>2) Water Filter Life Indicator Function After you replace the water filter Touch and hold this button for 3 seconds to reset the water filter life indicator. When you reset the water filter life indicator, the Filter icon on the panel turns Off. The Filter icon will turn red to let you know it is time to change the water filter after six months (about 300 gallons). Some areas have large amounts of lime in their water, which causes the water filter to clog more quickly. If this is the case in your area, you will have to change the filter more frequently than every six months.</p> |
| <p>(4) Lighting (Hold 3 sec for °C ↔ °F)</p> | <p>Lighting button serves two purposes:</p> <ul style="list-style-type: none"> - To turn the dispenser light on and off - To switch the temperature units between °C and °F <p>1) Light Function Touching the Lighting button turns on the Dispenser LED lamp in continuous mode so that it stays on continuously. The button also lights up. If you want the Dispenser lamp to come on only when someone uses the dispenser, press the Lighting button to turn the continuous mode off.</p> <p>2) To switch the temperature units Touch and hold this button for 3 seconds to select the type of temperature you want displayed. Each time you press and hold the button, the °C and °F temperature modes alternate and the °C and °F icon lights up, indicating your selection.</p> |
| <p>(5) Fridge (Hold 3 sec for Power Cool)</p> | <p>The Fridge button serves two purposes:</p> <ul style="list-style-type: none"> - To set the Fridge to your desired temperature. - To turn the power cool function on and off. <p>1) To set the Fridge temperature Press the Fridge button to set the refrigerator to your desired temperature. You can set the temperature between 44°F (7°C) and 34°F(1°C) .</p> <p>2) Power Cool function Touch and hold this button for 3 seconds to decrease the time needed to cool products in the Refrigerator. It can be helpful if you need to quickly cool easily spoiled items or if the temperature in the fridge has warmed dramatically (For example, if the door was left open).</p> |







| | |
|---|---|
| <p>(6) Ice Off (Hold 3 sec for Child Lock)</p> | <p>The Ice Off button serves two purposes:</p> <ul style="list-style-type: none"> - To turn the Ice maker on and off - To turn the power cool function on and off. <p>1) Ice Off Function If you don't want to make more ice, press the Ice Off button.</p> |
|  | <p>2) Child Lock Function Touch and hold this button for 3 seconds to lock the display and flex room panel and dispenser Buttons, so the buttons can not be used. The child lock icon lights up to indicate you've activated the child lock function. Press 3 seconds to unlock.</p> |
| <p>(7) Cubed / Crushed (Hold 3 sec for Sparkling On/Off)</p> | <p>The Cubed/Crushed button serves two purposes:</p> <ul style="list-style-type: none"> - To select the type of ice you want dispensed. - Sparkling Water Production Function On and Off <p>1) To Select the type of ice Press the Cubed/Crushed button to select the type of ice you want dispensed. Each time you press the button, the cubed and crushed ice modes alternate and the Cubed or Crushed ice icon lights up, indicating your selection.</p> <p>2) Sparkling Water Production Function On / Off Each time you press this button for 3 seconds, the Sparkling Water Production function switches on and off. When turning off the Sparkling Water Production function, the "OFF" Icon on the Display Panel will be turned on. When turning on the Sparkling Water Production function, the "OFF" Icon on the Display Panel will be turned off. When the Sparkling Water Production function is turned off, it does not produce soda beverages. (But, when it is in the middle of producing soda, it halts its function after finishing the current operation.) The refrigerators are being manufactured with the Sparkling Water Production function being set to "OFF". When connecting water lines, or either mounting or replacing the CO² Cylinder, turn off the Sparkling Water Production function. And, when finishing the work, turn on the Sparkling Water. (The Sparkling Water Production function will operate.)</p> |

| | |
|---|---|
| <p>(8) Sparkling Water (Hold 3 sec for Carbonation Level Change)</p> | <p>The Sparkling Water button serves two purposes:</p> <ul style="list-style-type: none"> - To select the Sparkling water you want dispensed. - Selecting the Carbonation Level of Sparkling Water when producing sparkling water <p>1) To Select the Sparkling Water To dispense soda beverage, press the Sparkling Water Button. When the Sparkling Water is selected, the Sparkling Icon will turn on. When it is in the middle of producing sparkling water, the Sparkling Icon keeps blinking. When it is in the middle of producing sparkling water, it does not dispense the sparkling water. So, please wait until it finishes producing sparkling water.</p> <p>2) Changing the Carbonation Level of Sparkling Water When pressing the Sparkling Water Button for 3 seconds, its level will be changed. Each time the button is pressed for 3 seconds, the Carbonation Level will be looped in the order of Medium (Level-2) → Strong (Level-3) → Weak (Level-1) → Medium (Level-2). The new Carbonation Level will be applied from the next production.</p> <ul style="list-style-type: none"> - When there is previously produced sparkling water inside, it dispenses sparkling water with the previous Carbonation Level. (Even if the Carbonation Level is changed, it does not affect until the next production.) - When the Carbonation Level is changed during the production of sparkling water (The Sparkling Icon is blinking), it produces sparkling water according to its previous Carbonation Level. |
|---|---|



| | |
|---|---|
| <p>(9) Ice Off</p> | <p>If you don't want to make more ice, touch the Ice Off button. The icon will light up and the Ice-Maker stops making ice.</p> <div style="display: flex; align-items: center; margin-bottom: 10px;"> <div style="margin-right: 10px;"></div> <p>We recommend you to stop ice making if the following occur:</p> <ul style="list-style-type: none"> - There is enough ice in the ice bucket. - You want to save water and energy. - Water is not being supplied to the refrigerator. </div> <div style="display: flex; align-items: center;"> <div style="margin-right: 10px;"></div> <div style="margin-right: 10px;"></div> <p>If the ice maker function is ON, and the water Line is not connected, there will be a water valve noise from the back of the unit. press the Ice Off (Hold 3sec for child lock) button for less than 3 seconds until the Ice Off Indicator () illuminates.</p> </div> |
|---|---|

If you do not press any button(letters not ICON), the display turns off in a few seconds.
If you press any button(letters not ICON) , the display lights up again.
The function key will operate after you remove your finger from the letters except Energy Saver Key.



| | |
|---|---|
| <p>(10) Filter</p> | <p>Water filter usage This icon will light up when you need to change the filter. After you use about 300 gallons of water, the filter indicator lights up. (about 6 months). After you install the new water filter, reset the filter indicator by touch and hold 3sec for Filter Reset button.</p> <div style="display: flex; align-items: center;"> <div style="margin-right: 10px;"></div> <div style="margin-right: 10px;"></div> <ul style="list-style-type: none"> - If water is not dispensing or dispensing slowly, you need to replace the water filter because the water filter is clogged. - Some areas have large amounts of lime in their water, which causes the water filter to clog more quickly. </div> |
|---|---|

| | |
|---|---|
| <p>(11) Cubed Ice/ Crushed Ice</p> | <p>Press the Cubed/Crushed button to select the type of ice you want dispensed. Each time you press the button, the cubed and crushed ice modes alternate and the Cubed or Crushed ice icon lights up, indicating your selection.</p> |
| <p> (Cubed)</p> <p> (Crushed)</p> | |

| | |
|--|---|
| <p>(12) Sparkling Water</p> | <p>To dispense sparkling water, press the Sparkling Water Button. When the Sparkling Water is selected, the Sparkling Icon will be on. When it is in the middle of producing sparkling water, the Sparkling Icon keeps blinking.</p> <p></p> <p>When it is in the middle of producing sparkling water, it does not dispense the sparkling water. So, please wait until it finishes producing sparkling water.</p> |
|--|---|

| | |
|---|---|
| <p>(13) Sparkling Water Production Level</p> | <p>It displays the currently set Carbonation Level. When pressing the Sparkling Water Button for 3 seconds, its level will be changed. Each time the button is pressed for 3 seconds, the Carbonation Level will be looped in the order of Medium (Level-2) → Strong (Level-3) → Weak (Level-1) → Medium (Level-2). The updated Carbonation Level will be applied from the next production.</p> <p> - When there is previously produced sparkling water inside, it dispenses sparkling water with the previous Carbonation Level. (Even if the Carbonation Level is changed, it does not affect until the next production.)</p> <p> - When the Carbonation Level is changed during the production of sparkling water (The Sparkling Icon is blinking), it produces sparkling water according to its previous Carbonation Level.</p> |
| <p>3</p> <p>2</p> <p>1</p> | |



| | |
|---|---|
| <p>(14) Sparkling Water Production Function Off</p> <p>OFF</p> | <p>Each time you press the Cubed/Crushed button for 3 seconds, the Sparkling Water Production function switches on and off.</p> <p>When turning off the Sparkling Water Production function, the “OFF” Icon on the Display Panel will be turned on.</p> <p>When turning on the Sparkling Water Production function, the “OFF” Icon on the Display Panel will be turned off.</p> <p>When the Sparkling Water Production function is turned off, it does not produce soda beverages. (But, when it is in the middle of producing soda, it halts its function after finishing the current operation.)</p> <p>The refrigerators are being manufactured with the Sparkling Water Production function being set to “OFF”.</p> <p>When turning on the Sparkling Water Production function after connecting the Water Line and the CO2 cylinder, it produces sparkling water.</p> <p> When water leak is detected in the Sparkling Water Production Module, the “OFF” Icon blinks. At this time, it stops dispensing and producing sparkling water, and the Sparkling Water Production function automatically switches to “OFF”. When water leak is detected in the Sparkling Water Production Module, the Sparkling Water Production function does not turn on even if the Cubed/ Crushed button is pressed for 3 seconds.</p> |
|---|---|

| | |
|---|---|
| <p>Cooling Off Mode</p> <p> + </p> | <p>- North American (US, Canada) Models Only ;</p> <p>Cooling Off mode (also called Shop mode), is designed for use by retailers when they are displaying refrigerators on the shop floor. In Cooling Off mode, the refrigerator’s fan motor and lights work normally, but the compressors do not run, and the refrigerator and freezer do not get cold. To start Cooling Off mode, touch and hold the Energy Saver button and the Freezer button for 5 seconds during normal operation. The refrigerator chime sounds and the temperature display flashes “OFF”.</p> <p>To cancel Cooling Off mode, touch and hold the Energy Saver and the Freezer buttons again for 5 seconds.</p> |
|---|---|

RF31FMED**

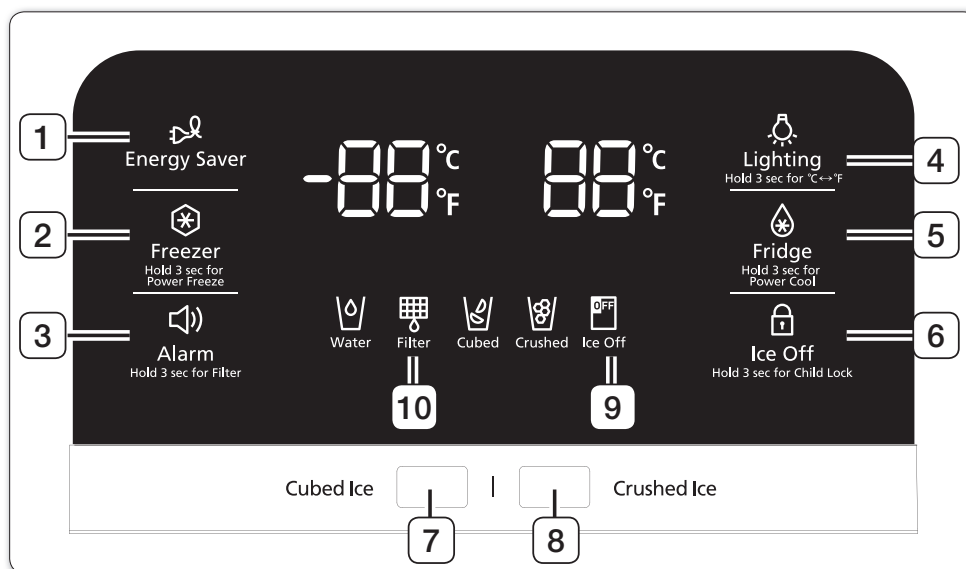
(For Ice/water model Only)





| | |
|--|---|
| <p>(1) Energy Saver</p>  | <p>Touching this button turns Energy Saver mode on and off. When you turn Energy Saver on, the Energy Saver icon lights. Turn Energy Saver off and the icon goes off. The Energy Saver function's factory setting is "ON". If condensation or water drops appear on the doors, turn the Energy Saver mode off.</p> |
| <p>(2) Freezer (Hold 3 sec for Power Freezer)</p>  | <p>The Freezer button serves two purposes:</p> <ul style="list-style-type: none"> - To set the Freezer to your desired temperature. - To turn the power freezer function on and off. <p>1) To set the Freezer temperature Touching the Freezer button to set the Freezer to your desired temperature. You can set the temperature between 5 °F (-15 °C) and -8 °F(-23 °C).</p> <p>2) Power Freezer function Touch and hold this button for 3 seconds to decrease the time needed to freeze products in the Freezer. It can be helpful if you need to quickly freeze easily spoiled items or if the temperature in the freezer has warmed dramatically (For example, if the door was left open).</p> |





| | |
|---|---|
| <p>(3) Alram (Hold 3 sec for Filter Reset</p> | <p>The Alarm button serves two purposes:</p> <ul style="list-style-type: none"> - To turn the door open alarm on and off - To reset the water filter life indicator. <p>1) Door Alarm Function</p> <p>If the door alarm is set to On, an alarm beeps if any refrigerator door is left open for more than three minutes. The beeping stops when you close the door. The door alarm function is pre-set to On in the factory. You can turn it off by pressing and then releasing the Alarm button. You can turn it back on in the same fashion. The icon lights up when the function is on.</p> <p>When the Door Alarm function is on and there is an alarm sound which is triggered by the door opening, the Door Alarm Icon will blink together with the alarm sound.</p> |
|  | <p>2) Water Filter Life Indicator Function</p> <p>After you replace the water filter Touch and hold this button for 3 seconds to reset the water filter life indicator. When you reset the water filter life indicator, the Filter icon on the panel turns Off. The Filter icon will turn red to let you know it is time to change the water filter after six months (about 300 gallons). Some areas have large amounts of lime in their water, which causes the water filter to clog more quickly. If this is the case in your area, you will have to change the filter more frequently than every six months.</p> |

| | |
|---|--|
| <p>(4) Lighting (Hold 3 sec for °C ↔ °F)</p> | <p>Lighting button serves two purposes:</p> <ul style="list-style-type: none"> - To turn the dispenser light on and off - To switch the temperature units between °C and °F <p>1) Light Function</p> <p>Touching the Lighting button turns on the Dispenser LED lamp in continuous mode so that it stays on continuously. The button also lights up. If you want the Dispenser lamp to come on only when some one uses the dispenser, press the Lighting button to turn the continuous mode off.</p> |
|  | <p>2) To switch the temperature units</p> <p>Touch and hold this button for 3 seconds to select the type of temperature you want displayed.</p> <p>Each time you press and hold the button, the °C and °F temperature modes alternate and the °C and °F icon lights up, indicating your selection.</p> |

| | |
|---|--|
| <p>(5) Fridge (Hold 3 sec for Power Cool)</p> | <p>The Fridge button serves two purposes:</p> <ul style="list-style-type: none"> - To set the Fridge to your desired temperature. - To turn the power cool function on and off. <p>1) To set the Fridge temperature</p> <p>Press the Fridge button to set the refrigerator to your desired temperature. You can set the temperature between 44°F (7°C) and 34°F(1°C) .</p> |
|  | <p>2) Power Cool function</p> <p>Touch and hold this button for 3 seconds to decrease the time needed to cool products in the Refrigerator. It can be helpful if you need to quickly cool easily spoiled items or if the temperature in the fridge has warmed dramatically (For example, if the door was left open).</p> |

| | |
|--|--|
| <p>(6) Ice Off (Hold 3 sec for Child Lock)</p> | <p>The Ice Off button serves two purposes:</p> <ul style="list-style-type: none"> - To turn the Ice maker on and off - To turn the power cool function on and off. <p>1) Ice Off Function If you don't want to make more ice, press the Ice Off button.</p> |
| <p></p> | <p>2) Child Lock Function Touch and hold this button for 3 seconds to lock the display and flex room panel and dispenser Buttons. so the buttons can not be used. The child lock icon lights up to indicate you've activated the child lock function. Press 3 seconds to unlock.</p> |

| | |
|--|--|
| <p>(7) Cubed Ice (8) Crushed Ice</p> | <p>Press the Cubed Ice or Crushed Ice button to select the type of ice you want dispensed. Each time you press the button, the cubed and crushed ice modes alternate and the Cubed or Crushed ice icon lights up, indicating your selection.</p> |
| <p> (Cubed)</p> <p> (Crushed)</p> | |

| | |
|---------------------------------|---|
| <p>(9) Ice Off</p> | <p>If you don't want to make more ice, touch the Ice Off button. The icon will light up and the Ice-Maker stops making ice.</p> <p></p> <p> We recommend you to stop ice making if the following occur:</p> <ul style="list-style-type: none"> - There is enough ice in the ice bucket. - You want to save water and energy. - Water is not being supplied to the refrigerator. <p> If the ice maker function is ON, and the water Line is not connected, there will be a water valve noise from the back of the unit. press the Ice Off (Hold 3sec for child lock) button for less than 3 seconds until the Ice Off Indicator () illuminates.</p> |
|---------------------------------|---|

If you do not press any button(letters not ICON), the display turns off in a few seconds.
If you press any button(letters not ICON) , the display lights up again.
The function key will operate after you remove your finger from the letters except Energy Saver, Cubed and Crushed Key.

**(10)
Filter**



Water filter usage

This icon will light up when you need to change the filter. After you use about 300 gallons of water, the filter indicator lights up. (about 6 months). After you install the new water filter, reset the filter indicator by touch and hold 3sec for Filter Reset button.



- If water is not dispensing or dispensing slowly, you need to replace the water filter because the water filter is clogged.
- Some areas have large amounts of lime in their water, which causes the water filter to clog more quickly.

**Cooling
Off Mode**



- North American (US, Canada) Models Only ;
Cooling Off mode (also called Shop mode), is designed for use by retailers when they are displaying refrigerators on the shop floor. In Cooling Off mode, the refrigerator's fan motor and lights work normally, but the compressors do not run, and the refrigerator and freezer do not get cold. To start Cooling Off mode, touch and hold the Energy Saver button and the Freezer button for 5 seconds during normal operation. The refrigerator chime sounds and the temperature display flashes OFF.
To cancel Cooling Off mode, touch and hold the Energy Saver and the Freezer buttons again for 5 seconds.

5. Troubleshooting

| PROBLEM | SOLUTION |
|--|---|
| The refrigerator does not work at all or it does not chill sufficiently. | <ul style="list-style-type: none"> • Check that the power plug is properly connected. • Check if the set temperature on the digital display is warmer than the freezer or fridge inner temperature. If it is, set the refrigerator colder. • Is the refrigerator in direct sunlight or located near a heat source? • Is the back of the refrigerator too close to the wall, preventing proper ventilation? |
| The food in the fridge is frozen. | <ul style="list-style-type: none"> • Check if the set temperature on the digital display is too low. • Try setting the refrigerator to a warmer temperature. • Is the temperature in the room too low? Set the refrigerator warmer. • Did you store the food which is juicy in the coldest part of the refrigerator? Try moving those items to the other shelves in the fridge instead of keeping them in the colder areas or bins. |
| You hear unusual noise or sounds. | <ul style="list-style-type: none"> • Check that the refrigerator is level and stable. • Is the back of the refrigerator too close to the wall, preventing proper ventilation? Try moving the back of the refrigerator at least 2 inches from the wall. • Was anything dropped behind or under the refrigerator? • A “ticking” sound is heard from inside the refrigerator. It is normal and occurs because various accessories are contracting or expanding according to the temperature of the refrigerator interior. • If it sounds as if something is hitting something else inside the refrigerator, this is normal. The sound is caused by the compressor operating at high capacity. |
| The cabinet-door sealing area of the appliance is hot and condensation is occurring. | <ul style="list-style-type: none"> • Some heat is normal as anti-condensators are installed in the vertical hinged section of the refrigerator to prevent condensation. • Is the refrigerator door ajar? Condensation can occur when you leave the door open for a long time. |
| Ice Maker is not producing ice. | <ul style="list-style-type: none"> • Did you wait for 12 hours after installation of the water supply line before making ice? • Is the water line connected and the shut-off valve opened? • Did you manually stop the ice making function? • Is the freezer temperature too warm? Try setting the freezer temperature lower. |
| You can hear water bubbling in the refrigerator. | <ul style="list-style-type: none"> • This is normal. The bubbling comes from refrigerant circulating through the refrigerator. |
| There is a bad smell in the refrigerator. | <ul style="list-style-type: none"> • Check for spoiled food. • Foods with strong odors (for example, fish) should be tightly covered. • Clean out your freezer periodically and throw away any spoiled or suspicious food. |
| Frost forms on the walls of the freezer. | <ul style="list-style-type: none"> • Is the air vent blocked? Remove any obstructions so air can circulate freely. • Allow sufficient space between the stored foods for efficient air circulation. • Is the freezer drawer closed properly? |
| Water dispenser is not functioning. | <ul style="list-style-type: none"> • Is the water line connected and the shut-off valve opened? • Has the water supply line tubing been crushed or kinked? • Make sure the tubing is free and clear of any obstruction. • Is the water tank frozen because the fridge temperature is too low? Try selecting a warmer setting on the Digital display. |
| Auto close system does not work with the freezer door. | <ul style="list-style-type: none"> • Is there an imbalance between the right and left parts of the door? • Open and close the door smoothly 1~2 times. After you do this, the auto close system usually works properly again. • Try opening the door smoothly to avoid unbalancing the right part and the left part of the door. |