

FISHER & PAYKEL

JOINER KIT

RF135B, RF170B & RF170W models

INSTALLATION GUIDE

US CA

COMPONENTS REQUIRED

- This kit is designed for use on 67 3/4"-high models and can be used to combine any variants of RF135B, RF170B and RF170W with handles.
- We recommend you save this installation guide for future reference.

ITEM	PART NUMBER
Kit Joiner Silver AJ-RF17X	819264

PARTS

Supplied

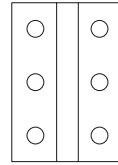

Rear bracket (1)

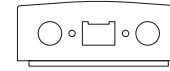

Front lower bracket (1)

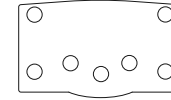

Front Upper bracket (1)

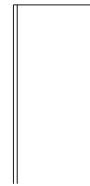

Centre trim (1)

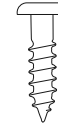

8x16 pan-head
Phillips screws (7)



5x20 hex-head
Phillips screws (6)

TOOLS

Not supplied

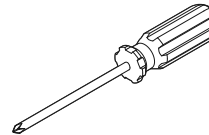

Phillips screwdriver

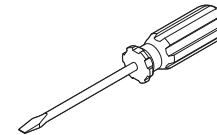

Flat-blade screwdriver

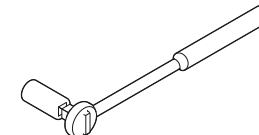

3/4" (19mm) socket wrench

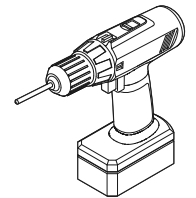

Battery drill with
90mm+ drill bit

PRODUCT DIMENSIONS - RF135B COMBINATIONS

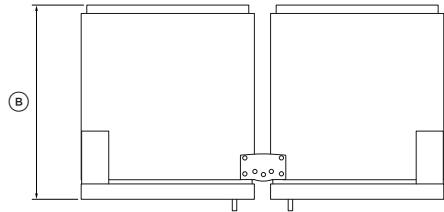

PLAN

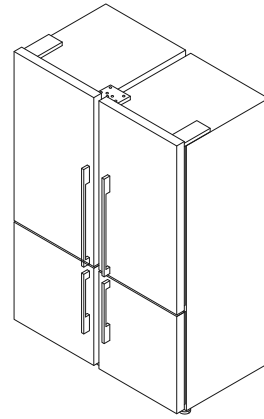

ISOMETRIC

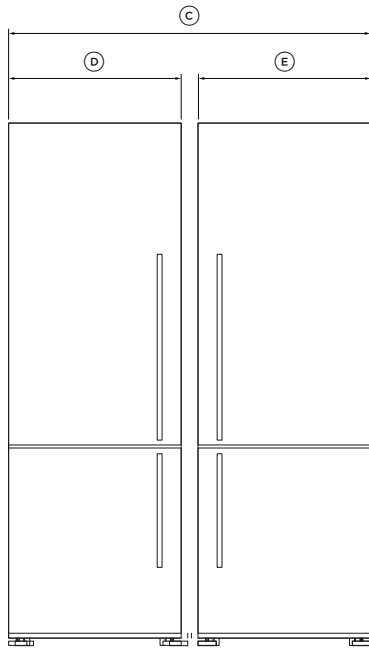

FRONT

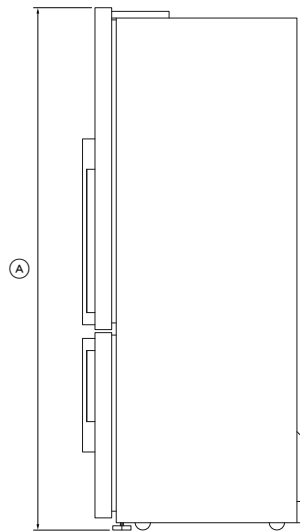

PROFILE

PRODUCT DIMENSIONS	RF135B + RF135B	
	IN	MM
(A) Overall height	67 3/4	1720
(B) Overall depth*	27 3/8	695
(C) Overall width	51	1295
(D) RF135B width	25	635

*Including rear compartment cover, excluding handle.

PRODUCT DIMENSIONS	RF135B + RF170B/W	
	IN	MM
(A) Overall height	67 3/4	1720
(B) Overall depth*	27 3/8	695
(C) Overall width	57	1450
(D) RF135B width	25	635
(E) RF170B/W width	32	790

*Including rear compartment cover, excluding handle.

PRODUCT DIMENSIONS - RF170B/W COMBINATIONS

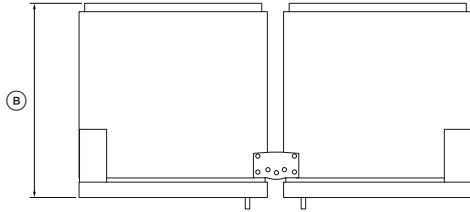

PLAN

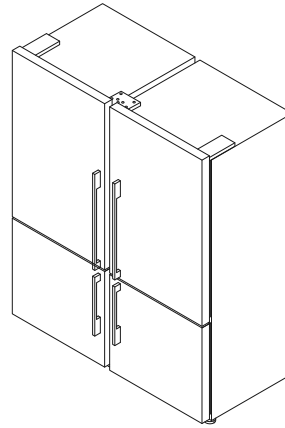

ISOMETRIC

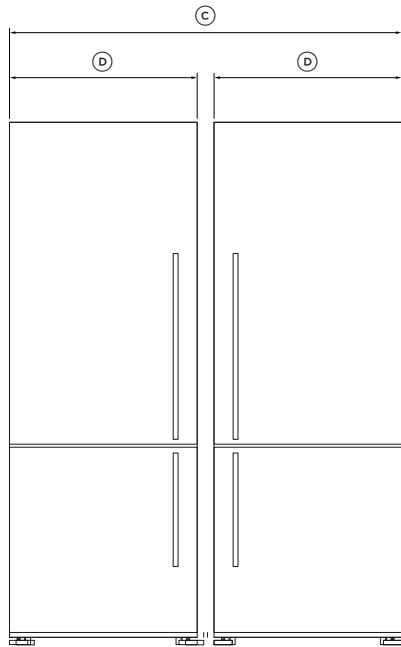

FRONT

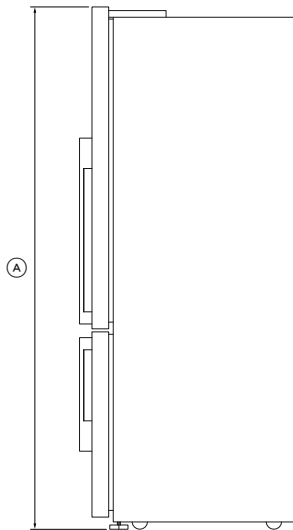

PROFILE

PRODUCT DIMENSIONS	RF170B/W + RF170B/W	
	IN	MM
Ⓐ Overall height	67 3/4	1720
Ⓑ Overall depth*	27 3/8	695
Ⓒ Overall width	63 1/8	1605
Ⓓ RF170B/W width	32	790

*Including rear compartment cover, excluding handle.

CAVITY DIMENSIONS - RF135B COMBINATIONS

PROUD INSTALL

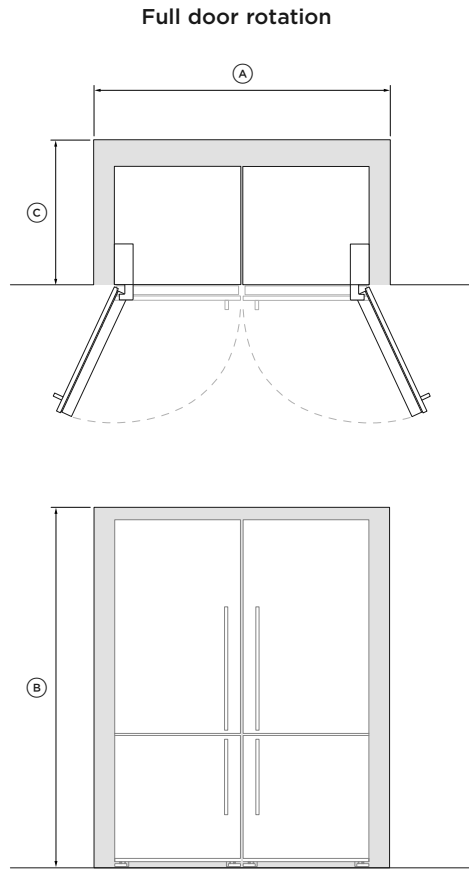

CAVITY DIMENSIONS	RF135B + RF135B		RF135B + RF170B/W	
	IN	MM	IN	MM
Ⓐ Width of cavity	52 9/16	1335	58 5/8	1490
Ⓑ Height of cavity	68 5/16	1735	68 5/16	1735
Ⓒ Depth of cavity	24 3/8	620	24 3/8	620

FLUSH INSTALL

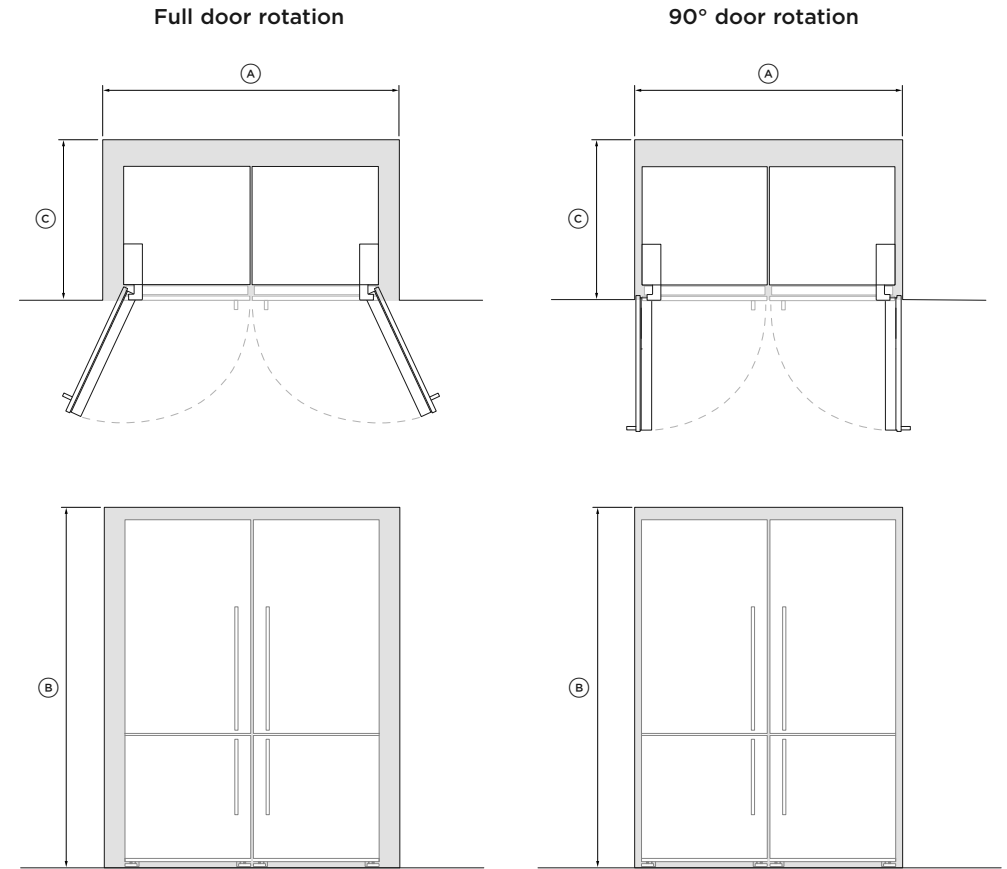

CAVITY DIMENSIONS	RF135B + RF135B		RF135B + RF170B/W		
	IN	MM	IN	MM	
Ⓐ Width of cavity	• Full door rotation	61 5/8	1565	67 3/4	1720
	• 90° door rotation	58 1/16	1475	64 3/16	1630
Ⓑ Height of cavity	68 5/16	1735	68 5/16	1735	
Ⓒ Depth of cavity	27 3/8	695	27 3/8	695	

CAVITY DIMENSIONS - RF170B/W COMBINATIONS

PROUD INSTALL

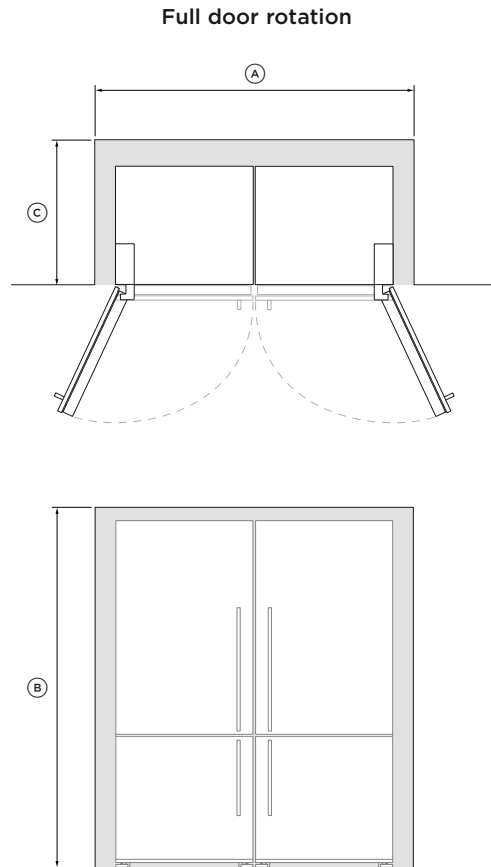

CAVITY DIMENSIONS	RF170B/W + RF170B/W	
	IN	MM
Ⓐ Width of cavity	64 3/4	1645
Ⓑ Height of cavity	68 5/16	1735
Ⓒ Depth of cavity	24 3/8	620

FLUSH INSTALL

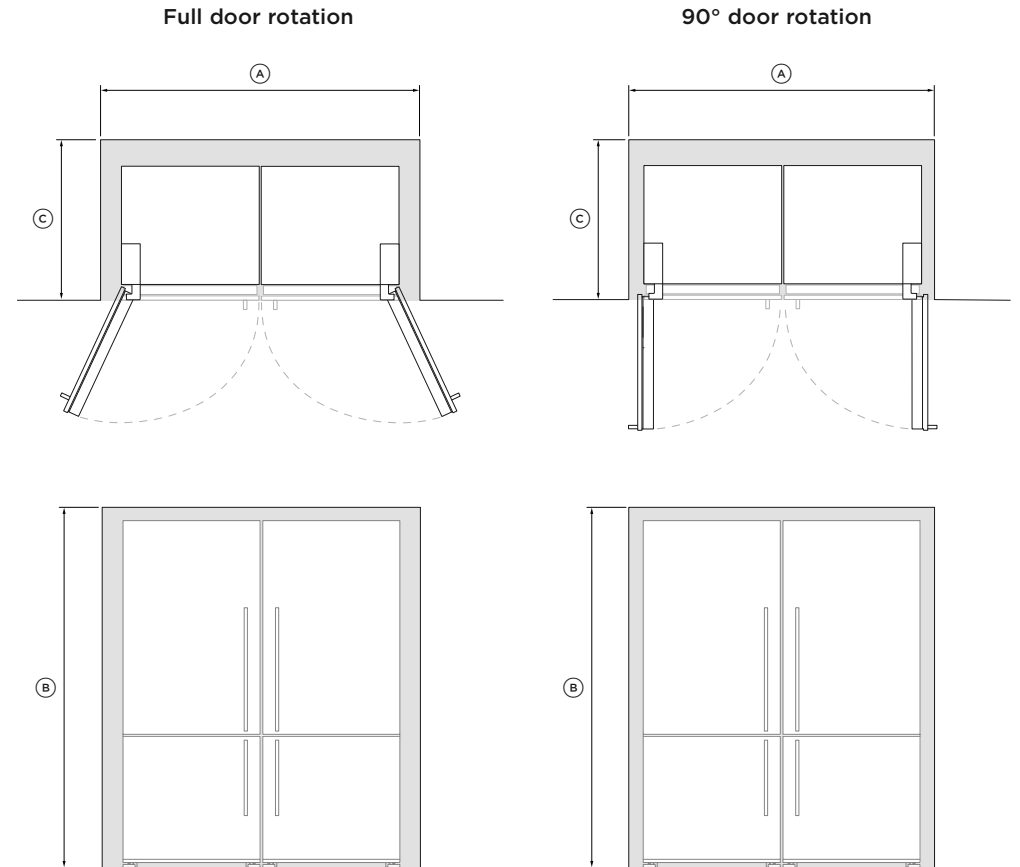

CAVITY DIMENSIONS	RF170B/W + RF170B/W	
	IN	MM
Ⓐ Width of cavity		
• Full door rotation	73 13/16	1875
• 90° door rotation	70 1/4	1785
Ⓑ Height of cavity	68 5/16	1735
Ⓒ Depth of cavity	27 3/8	695

CLEARANCES

PROUD INSTALL

Full door rotation

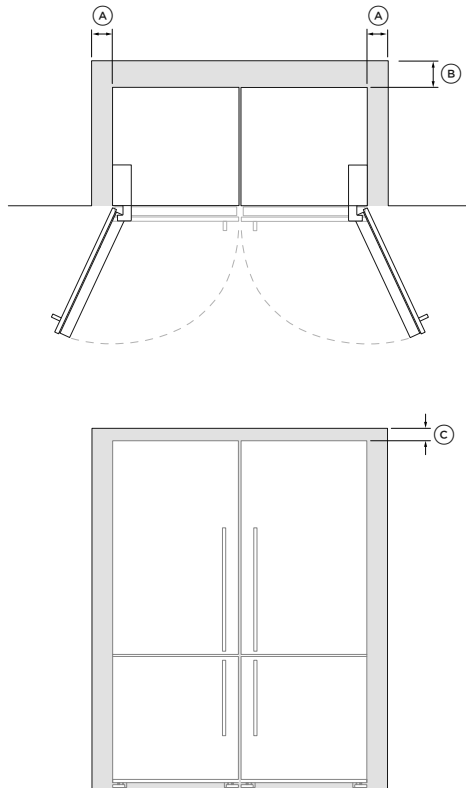

MINIMUM CLEARANCES

ALL MODELS

	IN	MM
Ⓐ Side clearance	3/4	20
Ⓑ Rear clearance (incl. evaporator tray)	1 3/16	30
Ⓒ Top clearance	2	50

FLUSH INSTALL

Full door rotation

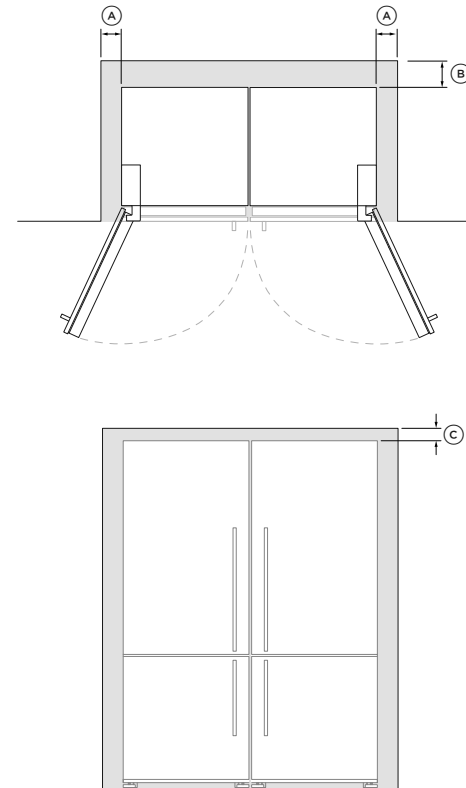

90° door rotation

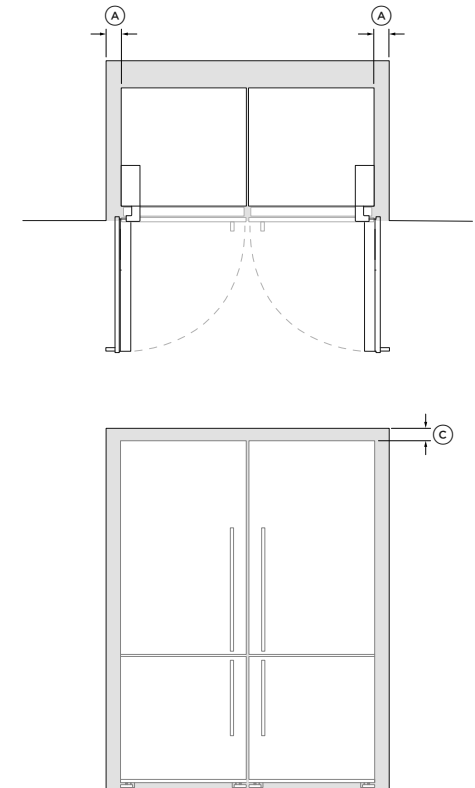

MINIMUM CLEARANCES

ALL COMBINATIONS

	IN	MM
Ⓐ Side clearance		
• Full door rotation	5 5/16	135
• 90° door rotation	3 9/16	90
Ⓑ Rear clearance (incl. evaporator tray)	1 3/16	30
Ⓒ Top clearance	2	50

INSTALLATION

Before you begin

- Check cavity dimensions are correct for the type of dual installation you require.
- Unpack appliances from packaging following guidance on individual cartons.
- Ensure the floor is protected from damage during unpacking and installation.
- Check that the Joiner Kit is complete.
- Always position the two appliances side-by-side with the door hinges on the far left and right, ensuring you have enough space to access the rear of the appliances.

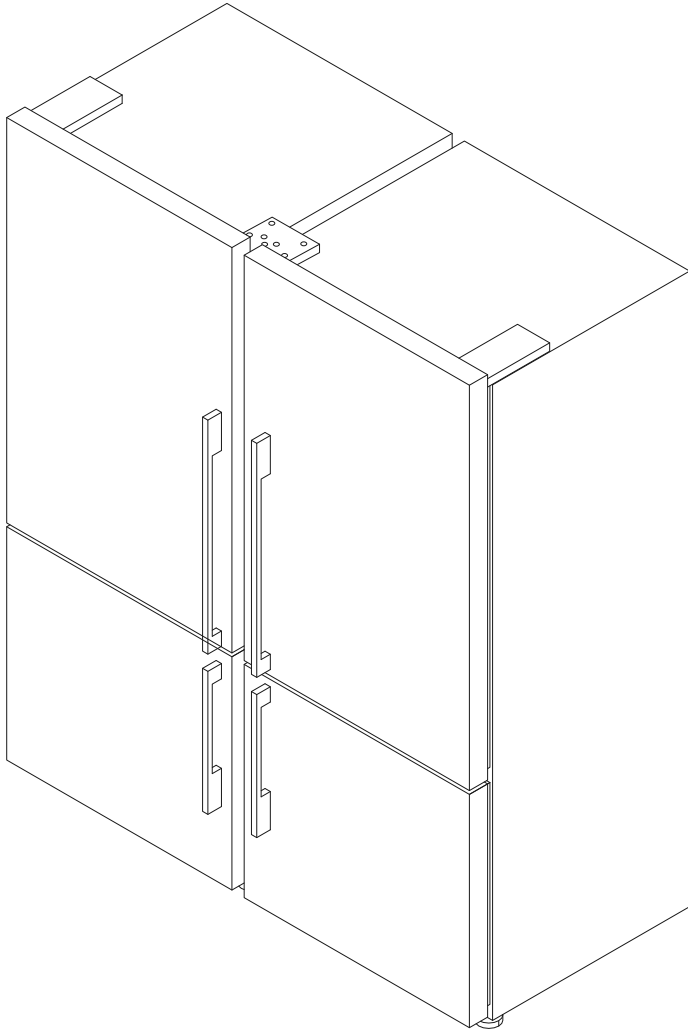

①

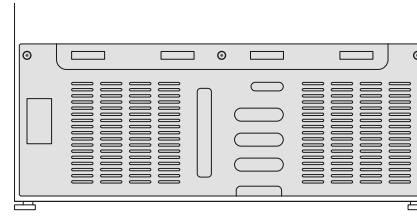

Remove the rear compartment cover using a Phillips screwdriver. This will be re-attached later.

②

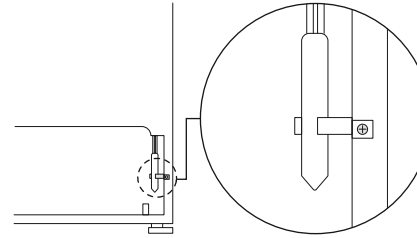

Remove the screw on the filter dryer retaining bracket using a Phillips screwdriver.

③

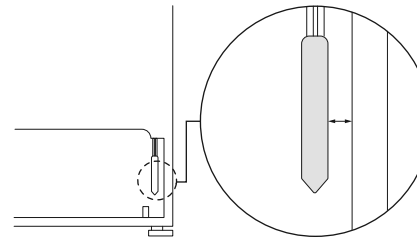

Remove the retaining bracket, ensuring the filter dryer does not touch any pipes or the side of the rear compartment.

④

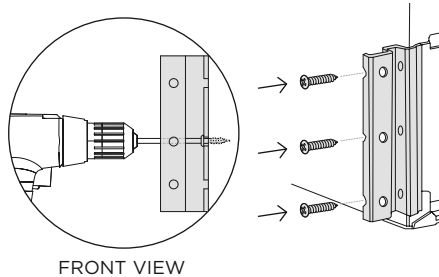

The rear bracket should only be added to the left-hand appliance as viewed from the front.

Align the top edge of the rear bracket to the bottom edge of the back panel. Holes for the bracket will need to be drilled into the side of the chassis. Secure bracket from the side using three of the 8x16 screws.

⑤

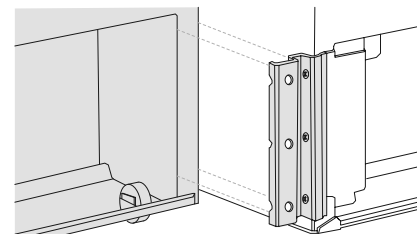

Slot the second, right-hand appliance as viewed from the front, into the bracket, ensuring it sits securely.

Do not fix in place.

INSTALLATION

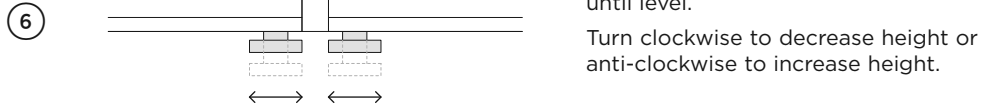

Adjust front feet of both appliances until level.
Turn clockwise to decrease height or anti-clockwise to increase height.

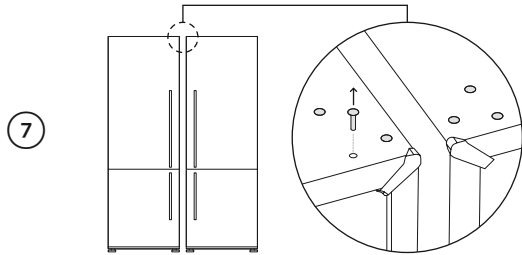

At the top of each appliance, remove the three screw caps using a flat-blade screwdriver.

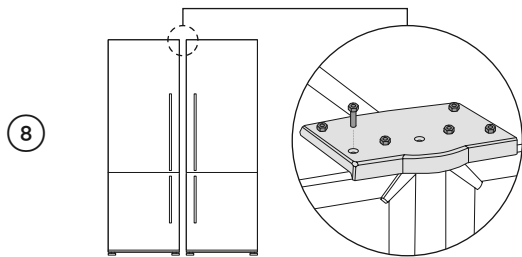

Align the front upper bracket to the screw holes.
Secure by partially engaging the 5x20 screws.

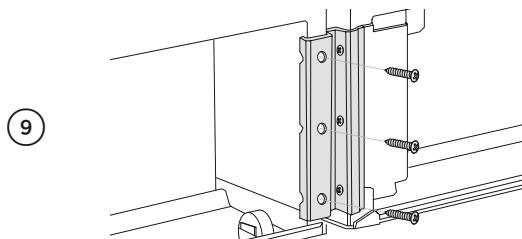

Ensure both appliances are level and aligned before securing the second appliance to the rear bracket using three 8x16 screws.
Replace both rear compartment covers using a Phillips screwdriver.

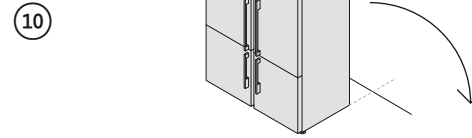

IMPORTANT!
Two people required.

Carefully tilt the connected appliances backwards to access the rear feet and the lower front bracket location.

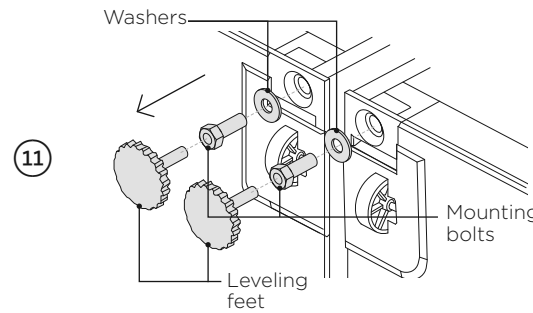

Remove the leveling feet from both appliances using a socket wrench by rotating them anti-clockwise.
Remove the mounting bolts and washers, and set aside.

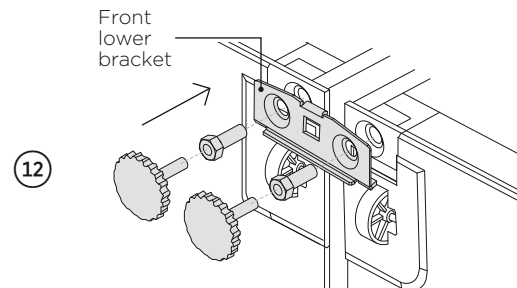

Align the front lower bracket to the spaces created by removing the leveling feet.
Ensure the bracket is correctly oriented as illustrated.
Secure using the leveling feet and mounting bolts before lowering the appliances carefully.

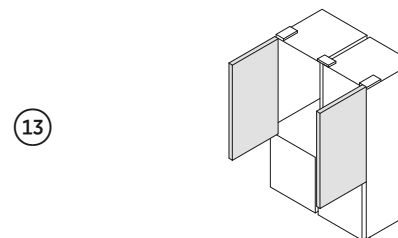

Open both doors for easy access to the center join.

INSTALLATION

14

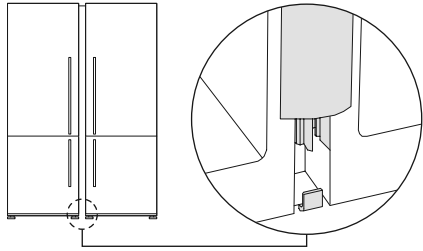

Locate the centre trim panel assembly to the tab on the lower bracket.

15

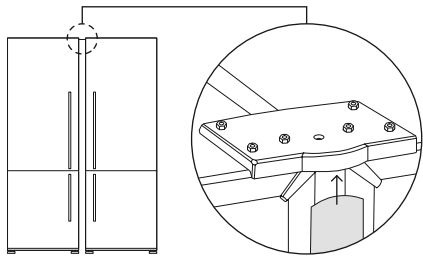

Position the centre trim panel under the upper bracket before re-tightening the six screws.

16

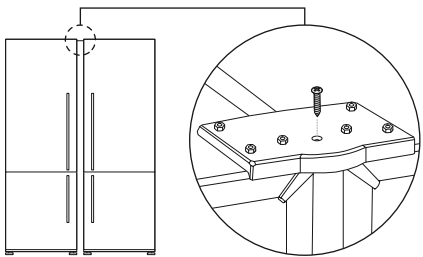

Secure the centre trim panel using the remaining 8x16 screw.

17

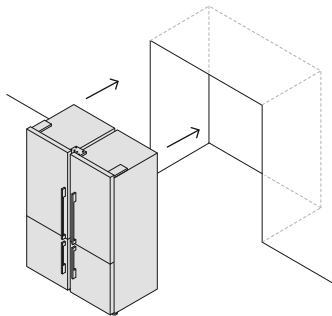

Close the doors and position the appliances within the cavity.

ADJUSTING DOOR ALIGNMENT

1

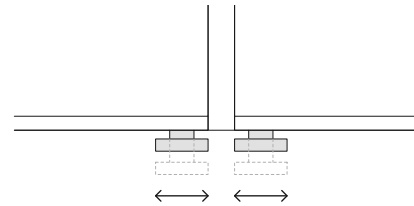

Ensure front leveling feet are adjusted correctly. Incorrect leveling may affect door alignment.

FISHERPAYKEL.COM

© Fisher & Paykel Appliances 2022. All rights reserved.

The models shown in this guide may not be available in all markets
and are subject to change at any time.

The product specifications in this guide apply to the specific products and
models described at the date of issue. Under our policy of continuous product
improvement, these specifications may change at any time.

For current details about model and specification availability in your country,
please go to our website or contact your local Fisher & Paykel dealer.

865192B 02.22