

RBMU36R



Product family	Refrigerator
Installation	Built-in
Category	Bottom mount
Built-in niche	>200
Reference width	Higher than 80
Reference height	Higher than 200
No-frost system	Total
Cooling type	No-frost
Defrost	Automatic
Hinge	Door-to-door
Kitchen panel	Not supplied
Hinge position	Right
EAN code	8017709332716



Aesthetic

Aesthetics	Universal	Drawers profile color	Silver
Material	Steel	Glass shelf profile color	Silver
Logo color	Silver	Display	TFT
Side material	Steel	Display position	Internal
Logo	Silkscreened	Water filter	Yes
Door shelf profile color	Silver	Available colors	Steel

Refrigerator compartment features



No. of adjustable shelves	3	Crisper cover	Yes
Number of fruit and vegetables drawers	2	Type of crisper cover	Glass
Type of adjustable shelves	Glass	Refrigerator lighting	Yes
Crisper drawer type	Sliding crisper	Refrigerator lighting	LED

Refrigerator Inner Door

Number of adjustable door shelves	3	Adjustable door bins with wire support	Yes
-----------------------------------	---	--	-----

Other Refrigerator features



MultiFlow Yes

Freezer features

Number of drawers	1	Freezer lighting	Yes
No. of lights	2	Freezer lighting	LED

Other Freezer features

Ice maker	Automatic	Ice-tray shelf	Yes
-----------	-----------	----------------	-----

Other technical features

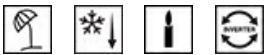

Display functions	Holiday, Fast-freezing, Fast-cooling, Temperature alarm, Showroom mode, Sabbath
Water network connection	Yes
Power-on light	Yes
Temperature alarm	Yes
Door open alarm	Yes
Temperature setting type	Electronic
No. of compressors	2
Refrigerant gas type	R600a
Compressor type	Inverter
Refrigerant quantity	6.0 oz
Foam agent	HFO

Performance / Energy Label NEW

Annual energy consumption	580 KWh/year	Refrigerator compartment	15.01 cu. ft.
Total volume	19.63 cu. ft.	Total volume	20.52 cu. ft.
Freezer volume	4.63 cu. ft.		

Electrical Connection





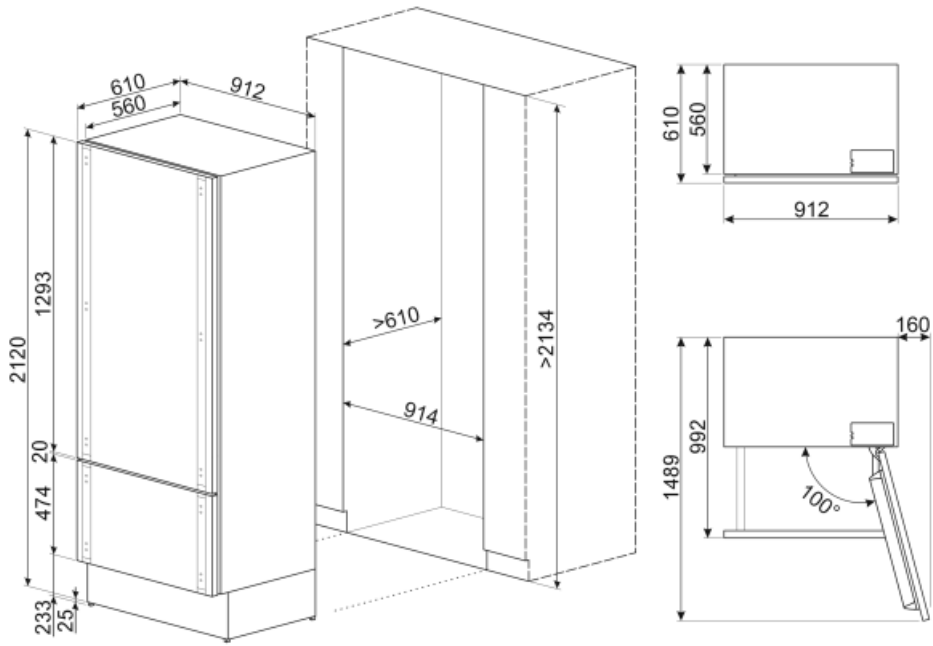

Plug	(B) USA 120V	Frequency (Hz)	60 Hz
Current	3,5 A	Power cord length	78 3/4 "
Voltage (V)	115 V		

Also available

Installation kit code RSFZLK



Symbols glossary (TT)

- | | | | |
|--|---|---|---|
|  | The automatic defrost system works by automatically defrosting at regular intervals eliminating the need to defrost altogether. |  | Fast freezing: The fast freezing function brings the temperature of the compartment down when activated a few hours prior to usage. |
|  | Power saving mode: The power saving mode allows you to disable the refrigerator and keep the freezer working. |  | LED interior lighting: is a more energy efficient and long lasting way of illuminating the interior of the appliance. |
|  | Inverter technology: The evolution of Smeg's driers towards more intelligent and environmentally sustainable models has led to the choice of using Inverter technology with heat pumps, which reduces significantly energy consumption. |  | Air plus: keeps food fresher for longer. |
|  | Sabbath: This function allows you to cook food during the Sabbath, the Holiday of rest in the Jewish religion, respecting the precepts. The oven works | | |