

# SAMSUNG

## Product Guide

### 5001 Series Refrigerator

RF28T5001SR

RF28T5001SG

RF28T5001WW

Available in: Fingerprint Resistant Stainless Steel,  
Fingerprint Resistant Black Stainless Steel and White.



# Table of Contents

## RF28T5001 – 28 cu. ft. Large Capacity 3-Door French Door Refrigerator

### Product Overview

Product Overview	4
Carousel Image Order	5

### Product Messaging

Features and Benefits	7
-----------------------	---

### Product Specs

Review Mapping and Related Product	12
Spec Sheet	13
Energy Guide and Manual	14

### Feature Icons

16

# Product Overview

---

RF28T5001SR – 28 cu. ft. Large Capacity 3-Door French Door Refrigerator

# Product Overview

## Product Title

28 cu. ft. Large Capacity 3-Door French Door Refrigerator

## Product Description\*

Samsung's 28 cu. ft. large capacity 3-Door French Door refrigerator is beautifully designed, with sleek-edged doors, and EZ-Open Handle.™ The clean lines and modern form blend beautifully into your kitchen while the fingerprint resistant finish withstands everyday smudges.

\*Product description should be updated based upon color setup.

## Available Colors



**Fingerprint Resistant  
Stainless Steel**  
RF28T5001SR



**Fingerprint Resistant  
Black Stainless Steel**  
RF28T5001SG



**White**  
RF28T5001WW



# Carousel Image Order

Easy Ad links

**RF28T5001SR:** R.COM - <http://www.samsungeasyads.com/mm/nicePath/easyads?nav=pr658971340>  
 S.COM - <http://www.samsungeasyads.com/mm/nicePath/easyads?nav=pr658972954>

**RF28T5001SG:** R.COM - <http://www.samsungeasyads.com/mm/nicePath/easyads?nav=pr658979715>  
 S.COM - <http://www.samsungeasyads.com/mm/nicePath/easyads?nav=pr658981536>

**RF28T5001WW:** R.COM - <http://www.samsungeasyads.com/mm/nicePath/easyads?nav=pr658969414>  
 S.COM - <http://www.samsungeasyads.com/mm/nicePath/easyads?nav=pr658970917>





# Product Messaging

---



RF28T5001SR – 28 cu. ft. Large Capacity 3-Door French Door Refrigerator

Easy Ads links: RF28T5001SR: <http://www.samsungeasyads.com/mm/nicePath/easyads?nav=pr658971141>  
 RF28T5001SG: <http://www.samsungeasyads.com/mm/nicePath/easyads?nav=pr658979921>  
 RF28T5001WW: <http://www.samsungeasyads.com/mm/nicePath/easyads?nav=pr658968886>

**Features and Benefits – RF28T5001SR**

Overall Product Headline	Feature Name	Long Body Copy	Short Body Copy	Associated Image
<p><b>More space, more ways to stay organized</b></p>	<p><b>Large Capacity</b></p>	<p>A completely redesigned interior with 28 cu. ft. capacity that fits 10% more groceries.*                      *When compared to Samsung 3-Door model RF2RF260BEAE with 25.5 cu. ft. capacity.</p>	<p>Fit more inside with 10% larger capacity.*                      *When compared to Samsung 3-Door model RF260BEAE with 25.5 cu. ft. capacity.</p>	
<p><b>N/A</b></p>	<p><b>Modern Design</b></p>	<p>Clean lines and modern form blend beautifully into your kitchen.</p>	<p>Clean lines and modern form blend beautifully</p>	
<p><b>N/A</b></p>	<p><b>Fingerprint Resistant Finish</b></p>	<p>A finish that withstands everyday smudges, so you spend less time cleaning.</p>	<p>Less smudges means less cleaning.</p>	



Easy Ads links: RF28T5001SR: <http://www.samsungeasyads.com/mm/nicePath/easyads?nav=pr658971141>  
 RF28T5001SG: <http://www.samsungeasyads.com/mm/nicePath/easyads?nav=pr658979921>  
 RF28T5001WW: <http://www.samsungeasyads.com/mm/nicePath/easyads?nav=pr658968886>

Features and Benefits – RF28T5001SR				
Overall Product Headline	Feature Name	Long Body Copy	Short Body Copy	Associated Image
Keep every item evenly cooled	All-Around Cooling	Multi-vent technology keeps items on every shelf evenly cooled.	Keeps every shelf evenly cooled.	 <p>The image shows a refrigerator with its doors open, displaying various items on the shelves. To the right, there is a diagram of a multi-vent cooling system with three circular vents. Below the diagram, the text reads "All-Around Cooling Even cooling everywhere".</p>
Ice Max™ ensures you have all the ice you need	Ice Max™	Large capacity ice maker, stores up to 5.5 lbs. of ice.	Stores up to 5.5 lbs. of ice.	 <p>The image shows a close-up of the ice maker bin, which is filled with a large quantity of clear, cube-shaped ice.</p>
A full-width drawer that fits in with your everyday needs	Full-Width Drawer	Large drawer space for storing party platters, deli items, beverages and more.	Large drawer space for additional items.	 <p>The image shows a full-width drawer pulled out, filled with various food items including lemons, oranges, and packaged beverages.</p>





Easy Ads links: RF28T5001SR: <http://www.samsungeasyads.com/mm/nicePath/easyads?nav=pr658971141>  
 RF28T5001SG: <http://www.samsungeasyads.com/mm/nicePath/easyads?nav=pr658979921>  
 RF28T5001WW: <http://www.samsungeasyads.com/mm/nicePath/easyads?nav=pr658968886>

**Features and Benefits – RF28T5001SR (continued)**

Overall Product Headline	Feature Name	Long Body Copy	Short Body Copy	Associated Image
N/A	<b>High-Efficiency LED Lighting</b>	LED lighting designed to beautifully light up the interior of your fridge so you can quickly spot what you want.	LED lighting designed to beautifully light up the interior of your fridge.	
N/A	<b>EZ-Open Handle™</b>	Specially designed handle allows for easy opening and closing of a fully loaded freezer. Automatically slides out for easy access, organization and storage.	Automatically slides out for easy access.	
N/A	<b>ENERGY STAR® Certified</b>	Eco-friendly and energy-efficient.** **Visit <a href="http://www.energystar.gov">www.energystar.gov</a> for more information on ENERGY STAR® guidelines.	Eco-friendly and energy-efficient.** **Visit <a href="http://www.energystar.gov">www.energystar.gov</a> for more information on ENERGY STAR® guidelines.	

Easy Ads links: RF28T5001SR: <http://www.samsungeasyads.com/mm/nicePath/easyads?nav=pr658971141>  
 RF28T5001SG: <http://www.samsungeasyads.com/mm/nicePath/easyads?nav=pr658979921>  
 RF28T5001WW: <http://www.samsungeasyads.com/mm/nicePath/easyads?nav=pr658968886>

**Features and Benefits – RF28T5001SR (continued)**

Overall Product Headline	Feature Name	Long Body Copy	Short Body Copy	Associated Image
N/A	<b>Accessibility (ADA Compliant)</b>	Easy-to-reach controls for everyone.	Easy-to-reach controls for everyone.	 <p>The image shows the refrigerator's control panel with a hand touching a button. A blue callout box indicates a height of 48.0 inches from the bottom to the controls. Another measurement of 55.0 inches is shown from the top of the refrigerator to the controls. A circular inset provides a close-up of the control panel, showing buttons for Power Cool, Freezer, Ice Maker On, Ice Maker, Water Dispenser, Door Alarm, and Lock.</p>
N/A	<b>Adjustable Shelving</b>	Middle shelf can be easily adjusted to fit taller items.	Easily adjustable shelf to fit taller items.	 <p>The image shows the interior of the refrigerator with a white adjustable shelf being moved up and down. The shelf is currently in a higher position. The control panel is visible on the right side of the image.</p>
N/A	<b>Sabbath Mode</b>	Adjusts your refrigerator to meet requirements of certain religious laws for holidays and days of rest.	Adjusts to meet certain religious laws for holidays and days of rest.	N/A

# Product Specs

---

**RF28T5001SR – 28 cu. ft. Large Capacity 3-Door French Door Refrigerator**

# Review Mapping

Model #	Type	Color
RF28T5001SR RF28T5001SG RF28T5001WW	3-Door French Door	Fingerprint Resistant Stainless Steel Fingerprint Resistant Black Stainless Steel White

# Related Product

Water Filter
HAF-QIN

# Spec Sheet

## Easy Ads link

<https://www.samsungeasyads.com/mm/nicePath/easyads?nav=pr659040966>

### RF28T5001SR

28 cu. ft. Large Capacity 3-Door French Door Refrigerator



**SAMSUNG**

### Signature Features

**Large Capacity**  
A completely redesigned interior with 28 cu. ft. capacity that fits 10% more groceries.\*

\*When compared to Samsung 3-Door model RF2608EAE with 25.5 cu. ft. capacity.

**Modern Design**  
Clean lines and modern form blend beautifully into your kitchen.

**Fingerprint Resistant Finish**  
A finish that withstands everyday smudges, so you spend less time cleaning.

**Available Colors**

- Fingerprint Resistant Stainless Steel (shown)
- Fingerprint Resistant Black Stainless Steel
- White



Large Capacity



Fingerprint Resistant Finish

**Design**

- Large Capacity of 28 cu. ft.
- Fingerprint Resistant Finish
- High-Efficiency LED Lighting
- EZ-Open Handle™

**Convenience**

- Full-width Drawer
- Adjustable Shelving

**Performance**

- All-Around Cooling
- Ice Max Ice Maker - Stores up to 5.5 lbs of ice
- Sabbath Mode

**Rating**



ENERGY STAR® rated: 645 kWh/yr



ADA Compliant

Spec Sheet - front

### RF28T5001SR

28 cu. ft. Large Capacity 3-Door French Door Refrigerator

**SAMSUNG**

**Installation Specifications**

1. Measure the height, width and depth of the opening, making sure to include baseboards, molding tile, countertop overhang, etc. Check to be sure there is enough room to open the door (consider walls, islands or other obstacles when measuring).
2. Refer to illustration below to determine dimensions.
3. Allow 2.5" of clearance on hinge side of refrigerator when installing next to a wall where handle may make contact.
4. Allow 1" minimum clearance at rear for proper air circulation and water/electrical connections. Allow a 3/8" minimum clearance at sides and top for ease of installation.
5. Ensure each door and entryway in the home is wide enough for the refrigerator to be moved through easily.

For optimal usage and ability to open refrigerator doors completely, do not install next to a wall.

Please note: The following dimension and cutout information is for planning purposes only. For complete installation details, consult manual packed with product, or download manual online at [samsung.com](http://samsung.com).

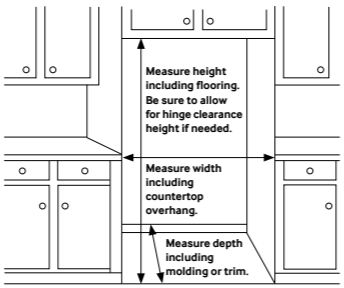

**Total Capacity: 28.2 cu. ft.**

**Refrigerator: 19.6 cu. ft.**

- Full-Width Drawer
- 5 Tempered Glass Spill-Proof Shelves
- 2 Humidity-Controlled Crispers
- 6 Door Bins
  - Right Door: 3 Gallon Bins
  - Left Door: 3 Gallon Bins
- Adjustable Shelves for Tall, Oversized Items
- High-Efficiency LED Lighting

**Freezer: 8.6 cu. ft.**

- EZ-Open Handle™
- 1 Large Opaque Bin with 1 Divider
- High-Efficiency LED Lighting

**Accessories**

Water Filter: HAF-QIN

**Warranty**

One (1) Year Parts and Labor on Refrigerator  
Five (5) Years Parts and Labor on Sealed Refrigeration System Only\*  
Ten (10) Years Parts and Five (5) Years Labor on Digital Inverter Compressor

\*Compressor, evaporator, condenser, drier and connecting tubing.

**Product Dimensions & Weight**

Dimensions (WxHxD with hinges, handles and doors): 35 3/4" x 70" x 35 3/8"

Dimensions (WxHxD without hinges and door): 35 3/4" x 68 7/8" x 28 7/8"

Dimensions (WxHxD with hinge and door, no handle): 35 3/4" x 70" x 32 7/8"

Weight: 276 lbs

**Shipping Dimensions & Weight (WxHxD)**

Dimensions: 37 23/32" x 75 7/16" x 35 29/32"

Weight: 284 lbs

**Dimensions**

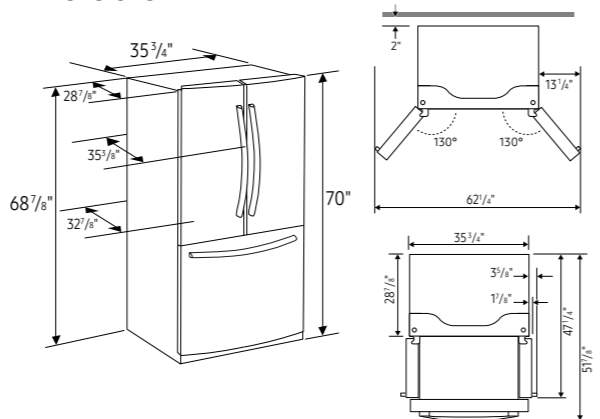

Color	Model #	UPC Code
Fingerprint Resistant Stainless Steel	RF28T5001SR	887276429380
Fingerprint Resistant Black Stainless Steel	RF28T5001SG	887276429373
White	RF28T5001WW	887276429397

Actual color may vary. Design, specifications, and color availability are subject to change without notice. Non-metric weights and measurements are approximate.  
©2020 Samsung Electronics America, Inc., 85 Challenger Road, Ridgefield Park, NJ 07660. Tel: 800-SAMSUNG. [samsung.com](http://samsung.com). Samsung is a registered trademark of Samsung Electronics Co., Ltd.

Spec Sheet - back

# Energy Guide and Manual

Easy Ads link

<https://www.samsungeasyads.com/mm/nicePath/easyads?nav=pr659040966>

U.S. Government Federal law prohibits removal of this label before consumer purchase.

# ENERGYGUIDE

Refrigerator-Freezer Samsung  
 • Automatic Defrost Model RF28T5001\*\*  
 • Bottom-Mounted Freezer Capacity: 28.2 Cubic Feet  
 • No Through-the-Door Ice Service

Compare **ONLY** to other labels with yellow numbers.  
 Labels with yellow numbers are based on the same test procedures.

Estimated Yearly Energy Cost  
**\$77**

Cost Ranges	Models with similar features	\$77	\$84
	All models	\$74	\$104

**645 kWh**  
 Estimated Yearly Electricity Use



- Your cost will depend on your utility rates and use.
- Both cost ranges based on models of similar size capacity.
- Models with similar features have automatic defrost, bottom-mounted freezer, and no through-the-door ice.
- Estimated energy cost based on a national average electricity cost of 12 cents per kWh.

[ftc.gov/energy](http://ftc.gov/energy)

Energy Guide

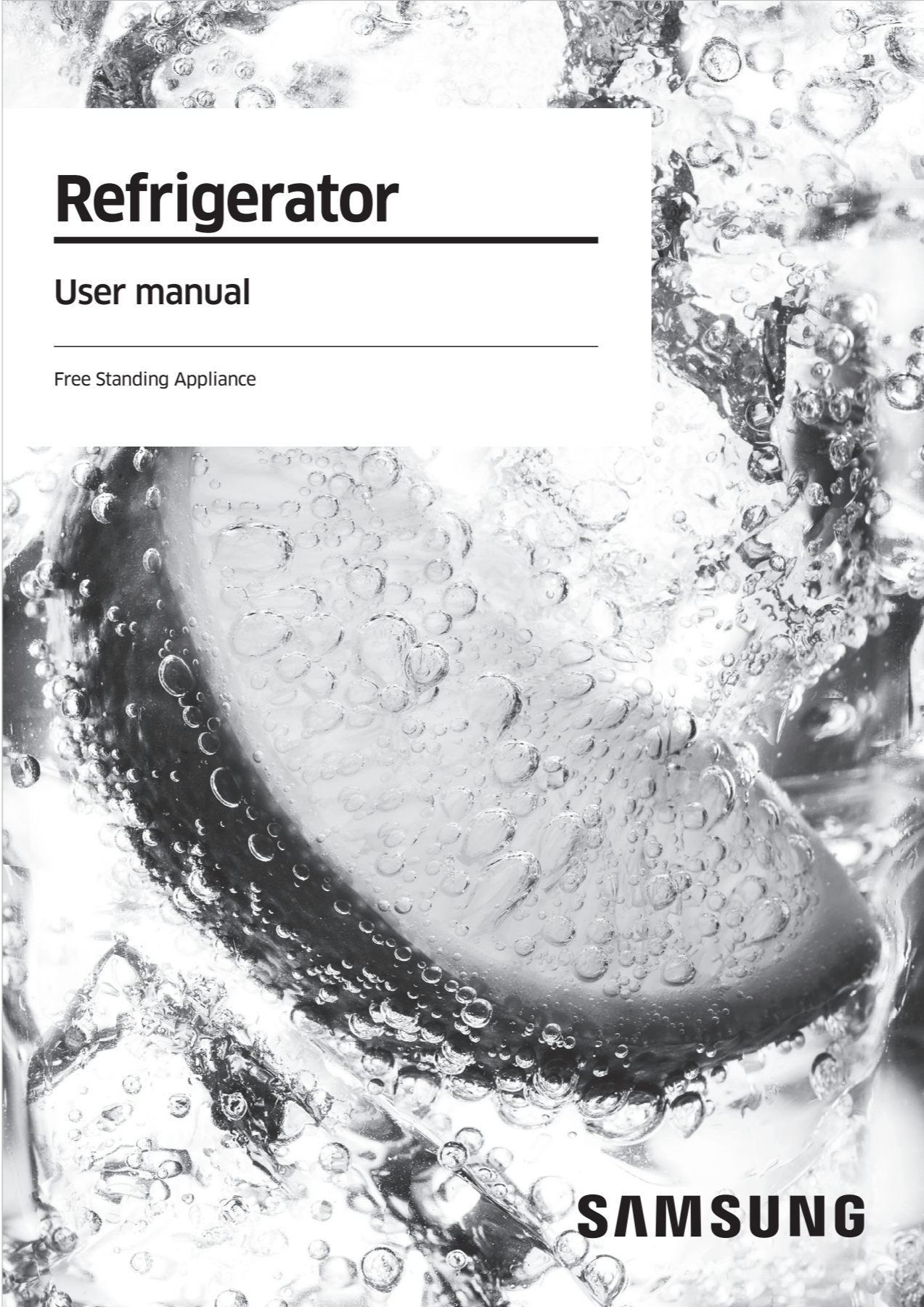

## Refrigerator

### User manual

Free Standing Appliance

**SAMSUNG**

User Manual

# Feature Icons

---

RF28T5001SR – 28 cu. ft. Large Capacity 3-Door French Door Refrigerator

# Feature Icons

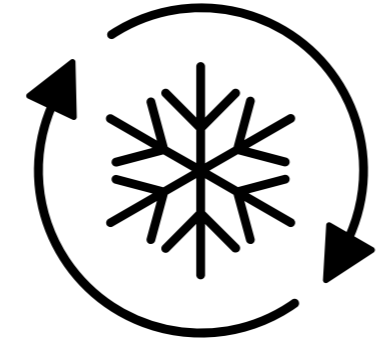

All-Around Cooling



Fingerprint Resistant Finish

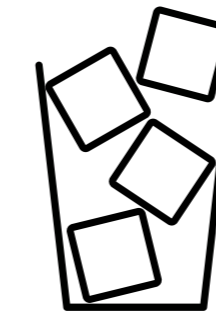

Ice Max™

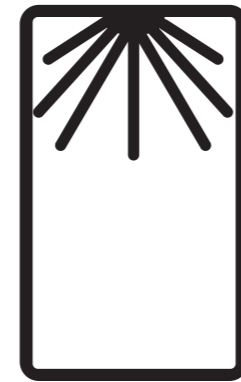

High-Efficiency LED Lighting



ENERGY STAR® Certified

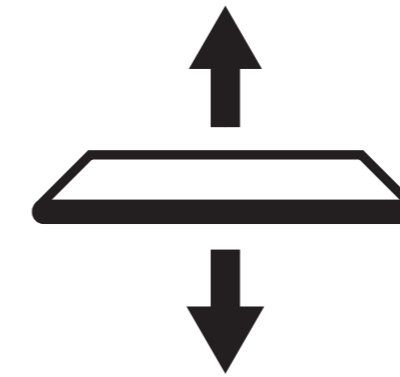

Adjustable Shelving



**SAMSUNG**